



US00D951415S

(12) **United States Design Patent** (10) **Patent No.:** **US D951,415 S**  
**Yang** (45) **Date of Patent:** **\*\* May 10, 2022**

(54) **AIR CLEANER**  
(71) Applicant: **SHENZHEN ANTOP TECHNOLOGY CO., LTD**, Shenzhen (CN)

D886,268 S \* 6/2020 Montagnino ..... D23/356  
D886,272 S \* 6/2020 Yang ..... D23/364  
D905,841 S \* 12/2020 Cao ..... D23/364  
D912,645 S \* 3/2021 Xi ..... D14/216

(Continued)

(72) Inventor: **Ruidian Yang**, Shenzhen (CN)  
(73) Assignee: **SHENZHEN ANTOP TECHNOLOGY CO., LTD**, Shenzhen (CN)

**FOREIGN PATENT DOCUMENTS**

CN 303613509 \* 3/2016  
CN 305500017 \* 12/2019

(\*\*) Term: **15 Years**  
(21) Appl. No.: **29/757,365**  
(22) Filed: **Nov. 5, 2020**

**OTHER PUBLICATIONS**

Douni Sleep Sound Machine, first available Apr. 1, 2019[online], [site visited Dec. 13, 2021]. Available from internet, URL:<https://www.amazon.com/dp/B07Q5TLB28> (Year: 2019).\*

(Continued)

(30) **Foreign Application Priority Data**  
Oct. 13, 2020 (CN) ..... 202030608317.X  
(51) **LOC (13) Cl.** ..... **23-04**  
(52) **U.S. Cl.**  
USPC ..... **D23/364**  
(58) **Field of Classification Search**  
USPC ..... D23/356, 359, 364-365, 378, 499  
CPC ..... F24F 1/029; F24F 1/035; F24F 1/0287;  
F24F 6/14; B05B 17/06  
See application file for complete search history.

*Primary Examiner* — Barbara Fox  
*Assistant Examiner* — Jamaal Rasheed  
(74) *Attorney, Agent, or Firm* — Avek IP, LLC; Kent R. Erickson

(56) **References Cited**  
U.S. PATENT DOCUMENTS

**CLAIM**

(57) The ornamental design for an air cleaner, as shown and described.

**DESCRIPTION**

FIG. 1 is a top perspective view of an air cleaner of the present invention;  
FIG. 2 is a bottom perspective view thereof;  
FIG. 3 is a front elevation view thereof;  
FIG. 4 is a rear elevation view thereof;  
FIG. 5 is a left elevation view thereof;  
FIG. 6 is a right elevation view thereof;  
FIG. 7 is a top plan view thereof; and,  
FIG. 8 is a bottom plan view thereof.  
The broken lines shown in the drawings are for the purpose of illustrating portions of the air cleaner that form no part of the claimed design.

**1 Claim, 8 Drawing Sheets**

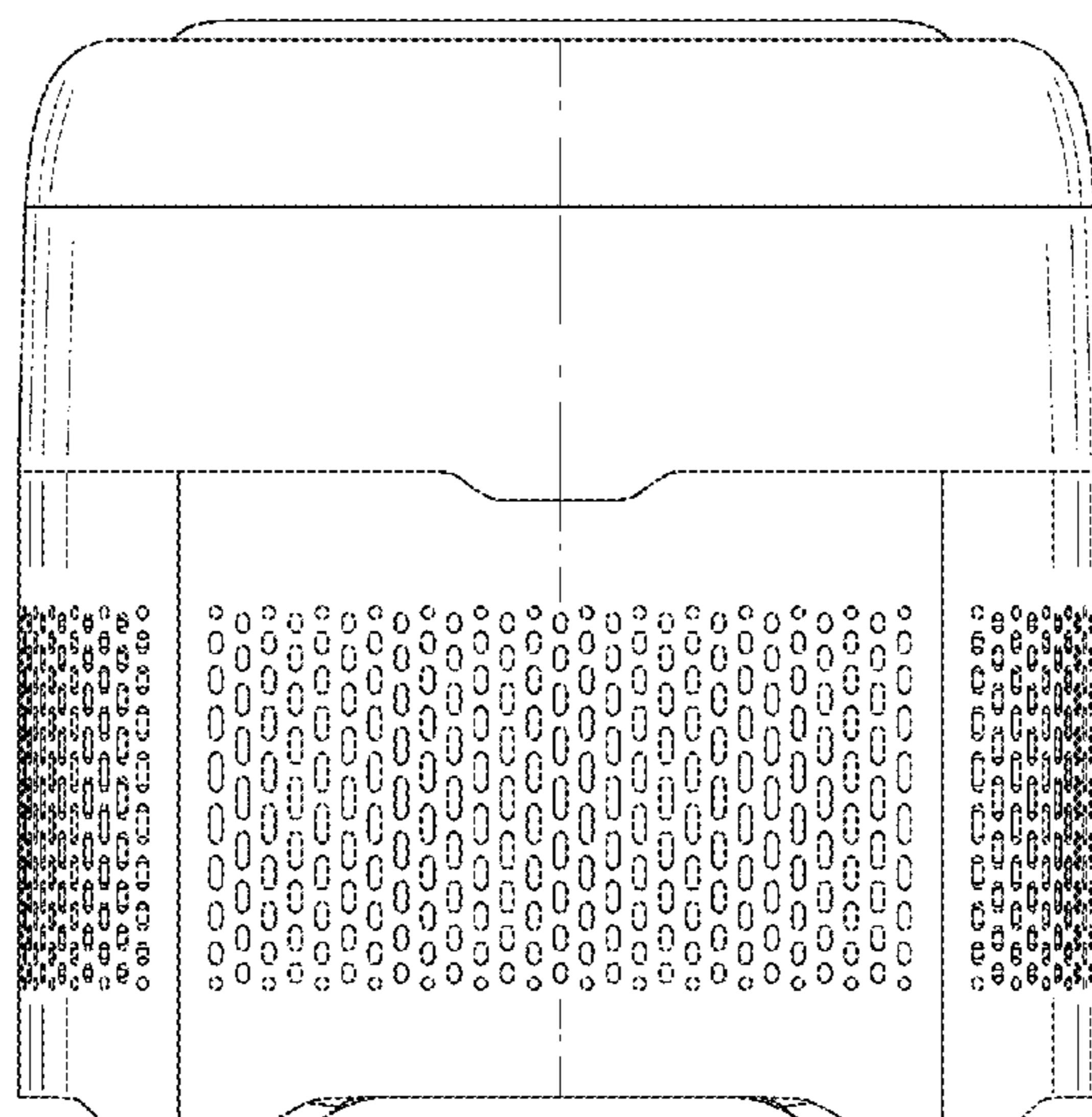

(56)

**References Cited**

U.S. PATENT DOCUMENTS

D936,809 S \* 11/2021 Shen ..... D23/364  
D937,436 S \* 11/2021 He ..... D24/231

OTHER PUBLICATIONS

Koios Upgraded Air Purifier, first available Sep. 13, 2017[online],  
[site visited Dec. 13, 2021]. Available from internet, URL:<<https://www.amazon.ca/dp/B07FLY8YD6>> (Year: 2017).\*

\* cited by examiner

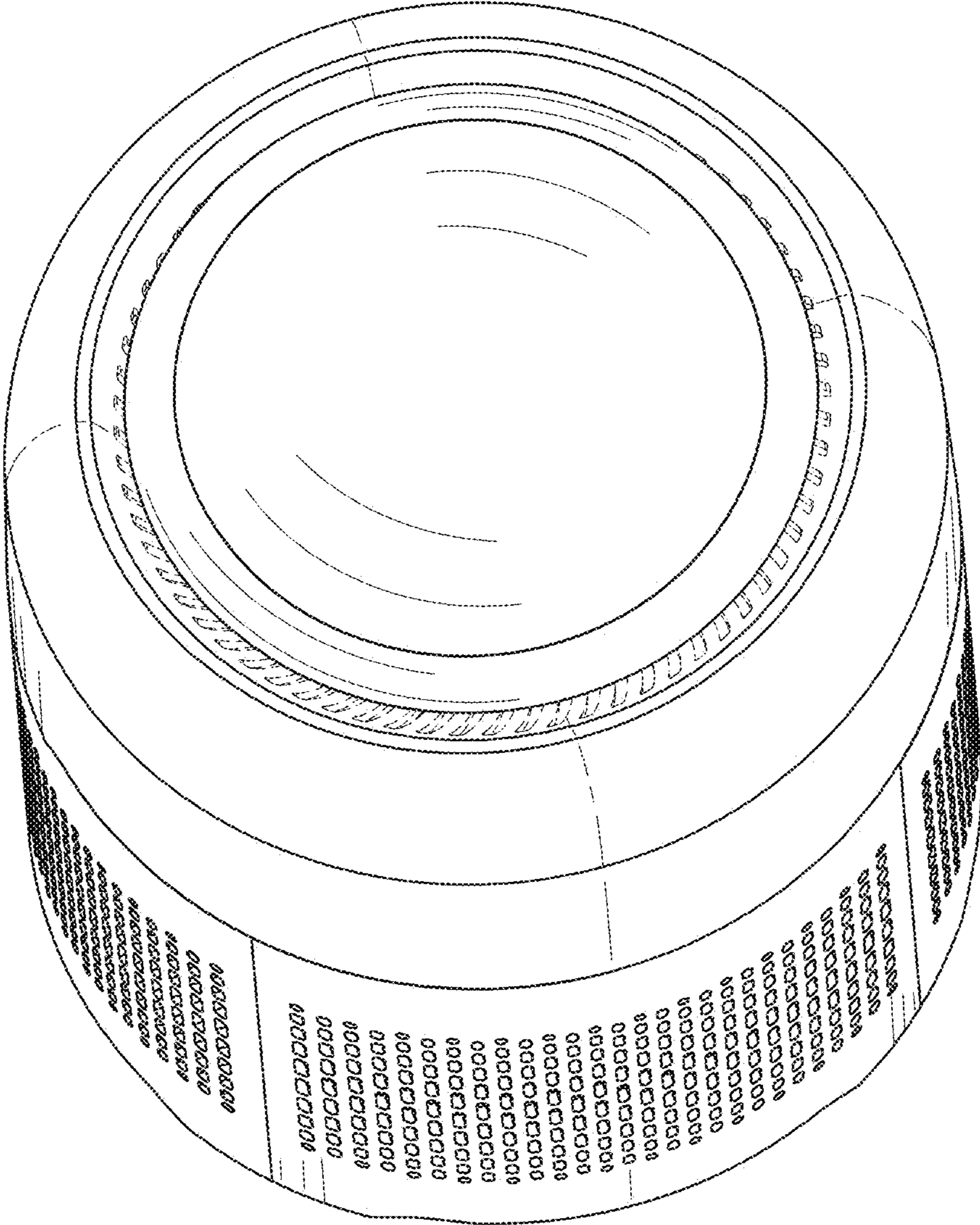

FIG. 1



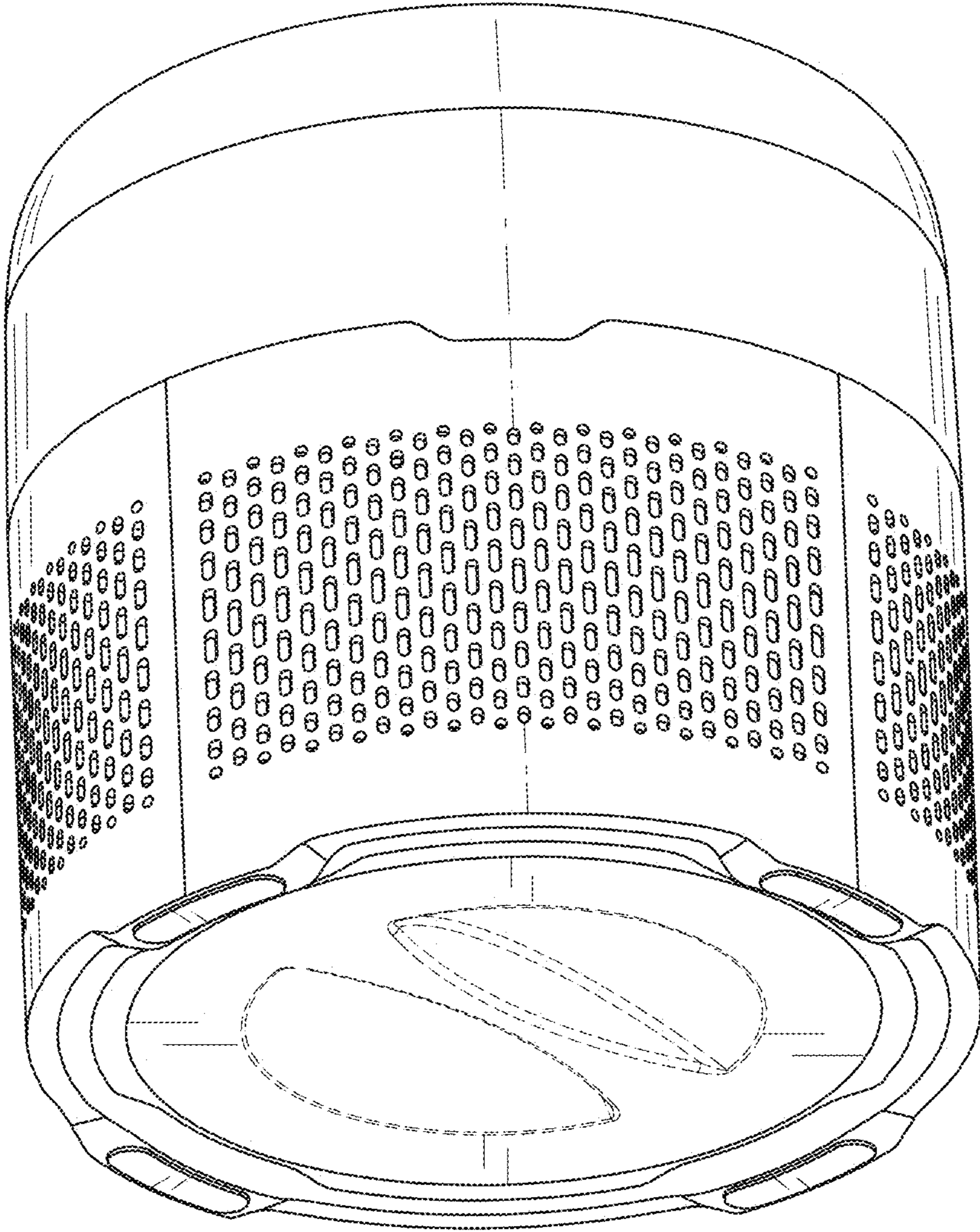

FIG. 2

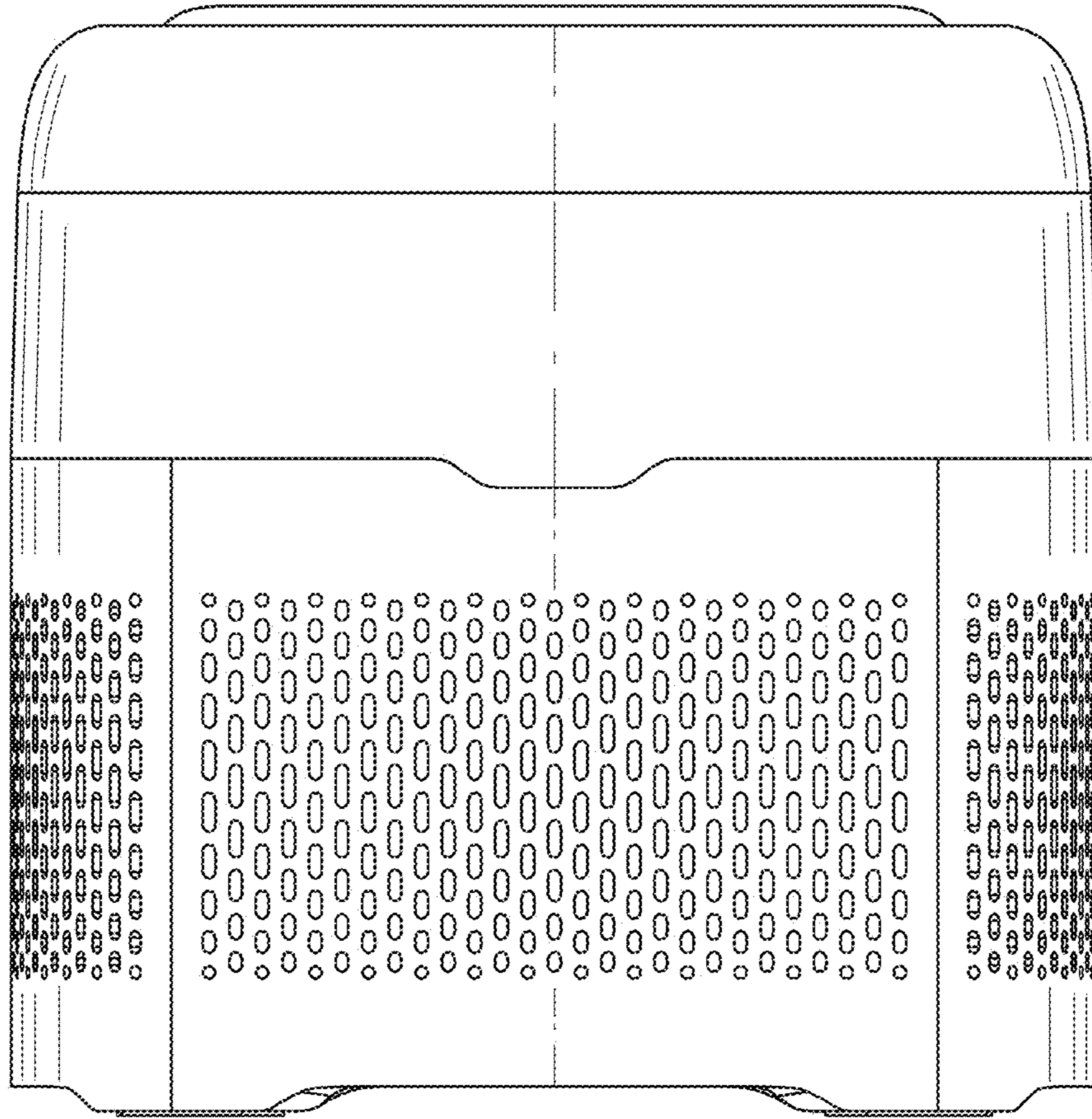

FIG. 3

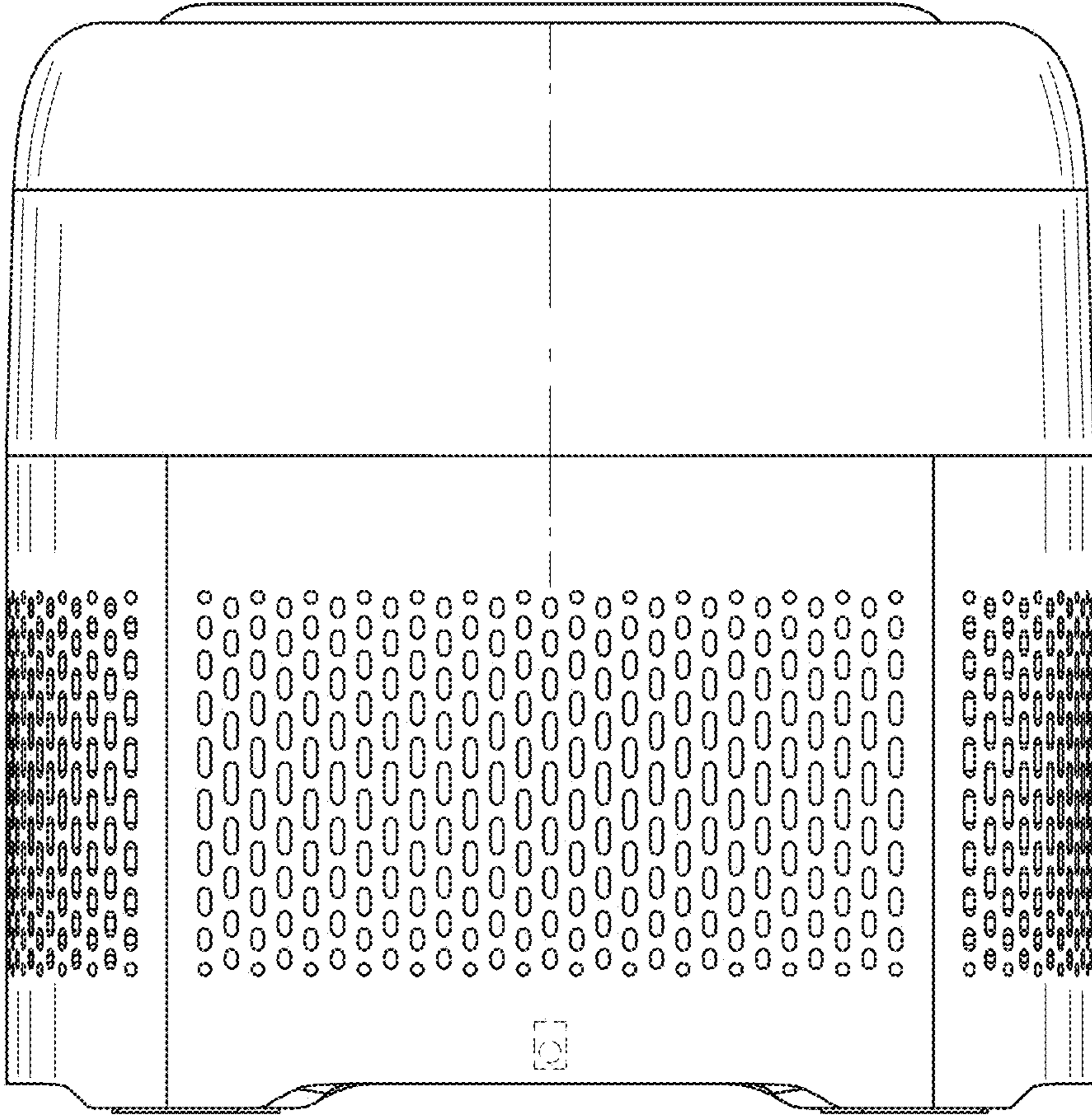

FIG. 4



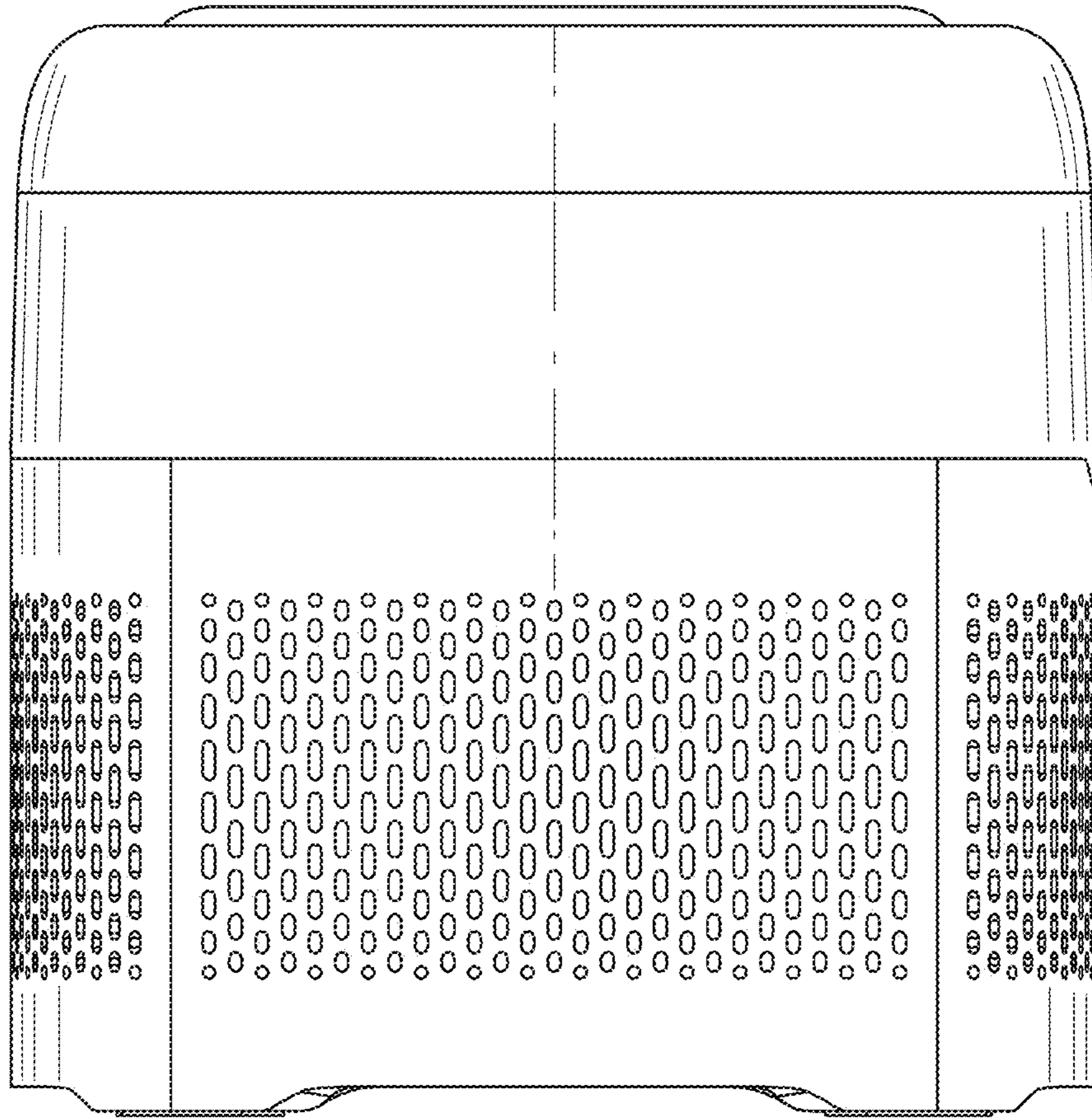

FIG. 5

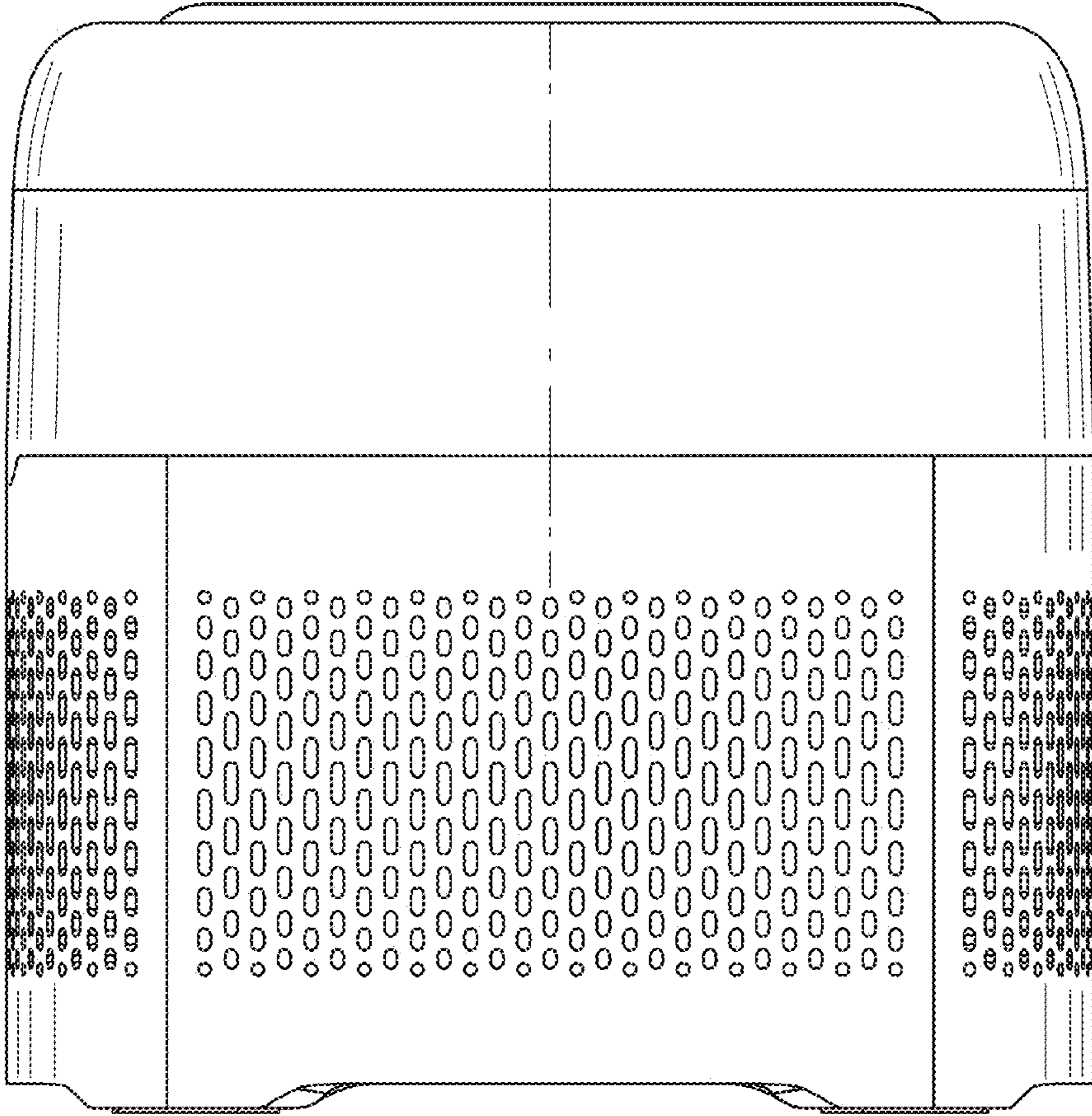

FIG. 6



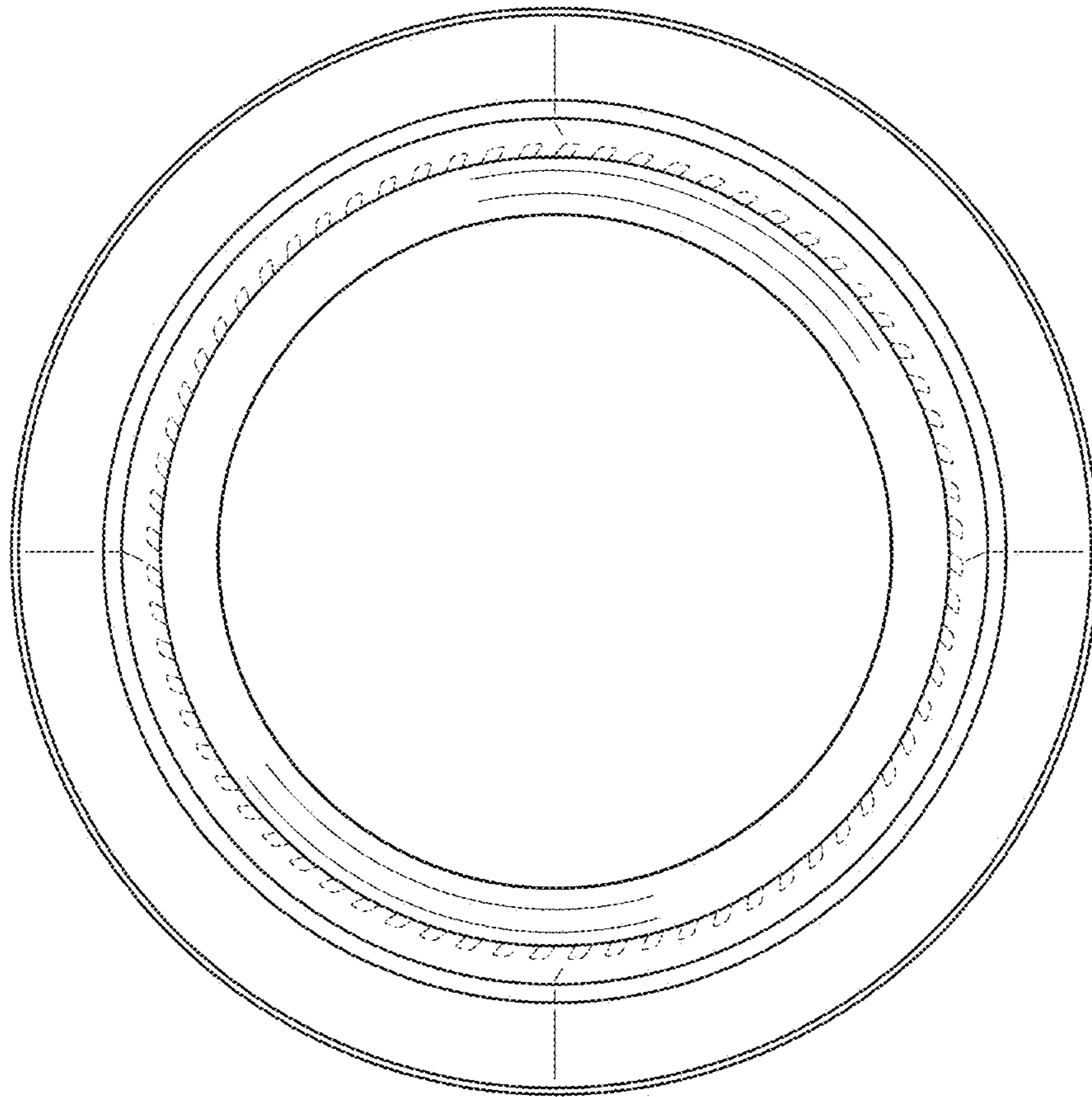

FIG. 7

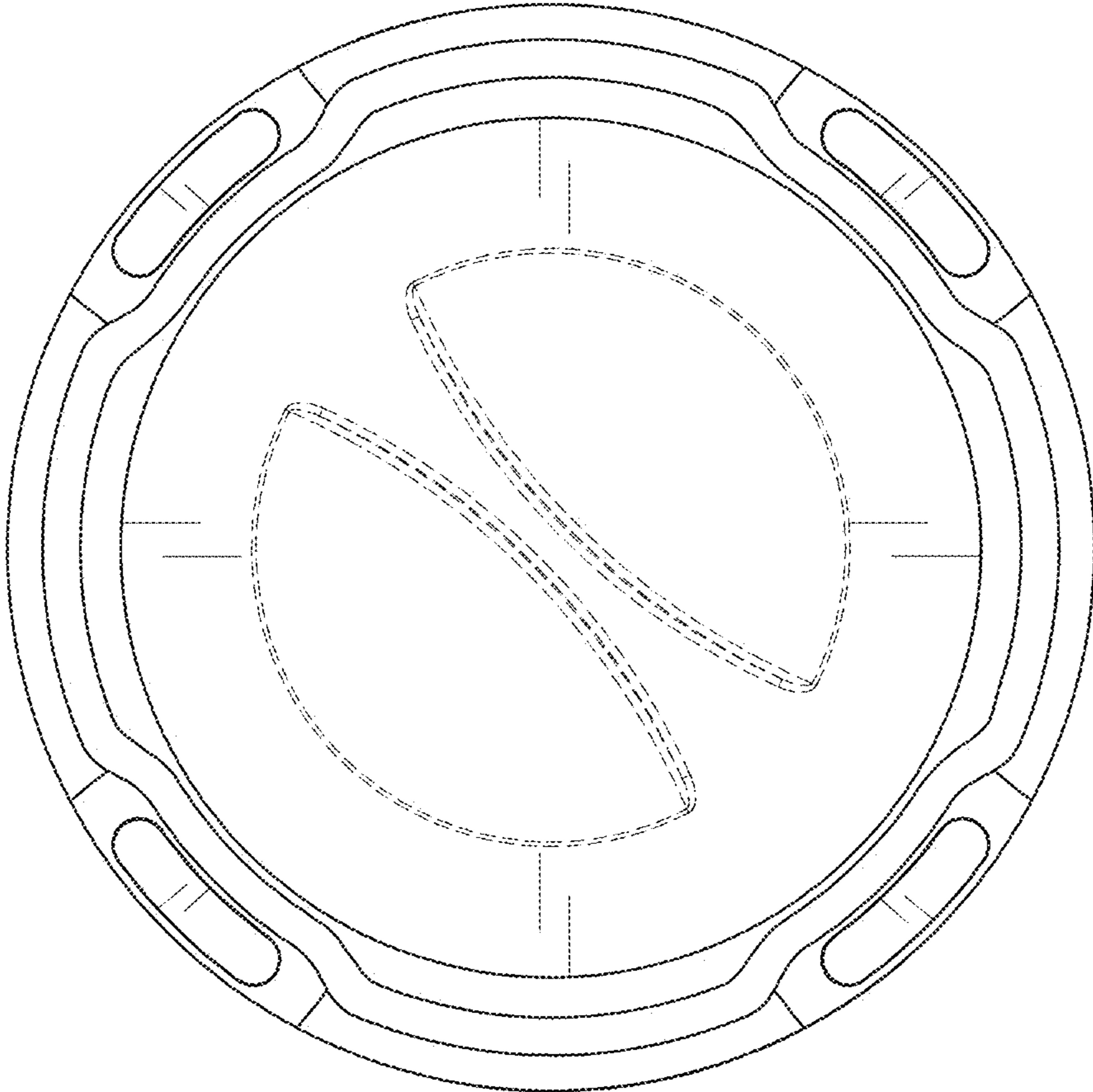

FIG. 8