



US00D951379S

(12) **United States Design Patent**
Andrews

(10) **Patent No.:** **US D951,379 S**

(45) **Date of Patent:** **** May 10, 2022**

(54) **GOLF CLUB HEAD**

(71) Applicant: **PARSONS XTREME GOLF, LLC**,
Scottsdale, AZ (US)

(72) Inventor: **Matthew T. Andrews**, Tempe, AZ (US)

(73) Assignee: **PARSONS XTREME GOLF, LLC**,
Scottsdale, AZ (US)

(**) Term: **15 Years**

(21) Appl. No.: **29/748,373**

(22) Filed: **Aug. 28, 2020**

(51) **LOC (13) Cl.** **21-02**

(52) **U.S. Cl.**
USPC **D21/736**

(58) **Field of Classification Search**
USPC **D21/736-746, 759**

(Continued)

(56) **References Cited**

U.S. PATENT DOCUMENTS

723,534 A 3/1903 Knight
922,444 A 5/1909 Youds

(Continued)

FOREIGN PATENT DOCUMENTS

JP 2004223184 A 8/2004
JP 2005160691 A 6/2005

(Continued)

OTHER PUBLICATIONS

Plugged In Golf (2015 Bettinardi Putters Review) [online]. Mar. 3, 2015, [retrieve Nov. 25, 2019] Retrieve from the internet.

(Continued)

Primary Examiner — Mitchell I. Siegel

(57) **CLAIM**

The ornamental design for a golf club head, as shown and described.

DESCRIPTION

FIG. 1 is a top perspective view of a golf club head;
FIG. 2 is a bottom perspective view of the golf club head of FIG. 1;
FIG. 3 is a front elevational view of the golf club head of FIG. 1;
FIG. 4 is a rear elevational view of the golf club head of FIG. 1;
FIG. 5 is a top view of the golf club head of FIG. 1;
FIG. 6 is a bottom view of the golf club head of FIG. 1;
FIG. 7 is a left side view of the golf club head of FIG. 1;
FIG. 8 is a right side view of the golf club head of FIG. 1;
FIG. 9 is a top perspective view of a second embodiment of a golf club head;
FIG. 10 is a bottom perspective view of the golf club head of FIG. 9;
FIG. 11 is a front elevational view of the golf club head of FIG. 9;
FIG. 12 is a rear elevational view of the golf club head of FIG. 9;
FIG. 13 is a top view of the golf club head of FIG. 9;
FIG. 14 is a bottom view of the golf club head of FIG. 9;
FIG. 15 is a left side view of the golf club head of FIG. 9;
FIG. 16 is a right side view of the golf club head of FIG. 9;
FIG. 17 is a top perspective view of a third embodiment of a golf club head;
FIG. 18 is a bottom perspective view of the golf club head of FIG. 17;
FIG. 19 is a front elevational view of the golf club head of FIG. 17;
FIG. 20 is a rear elevational view of the golf club head of FIG. 17;
FIG. 21 is a top view of the golf club head of FIG. 17;
FIG. 22 is a bottom view of the golf club head of FIG. 17;
FIG. 23 is a left side view of the golf club head of FIG. 17;
and,
FIG. 24 is a right side view of the golf club head of FIG. 17.
The broken lines shown on the drawings form no part of the claimed design.

1 Claim, 21 Drawing Sheets

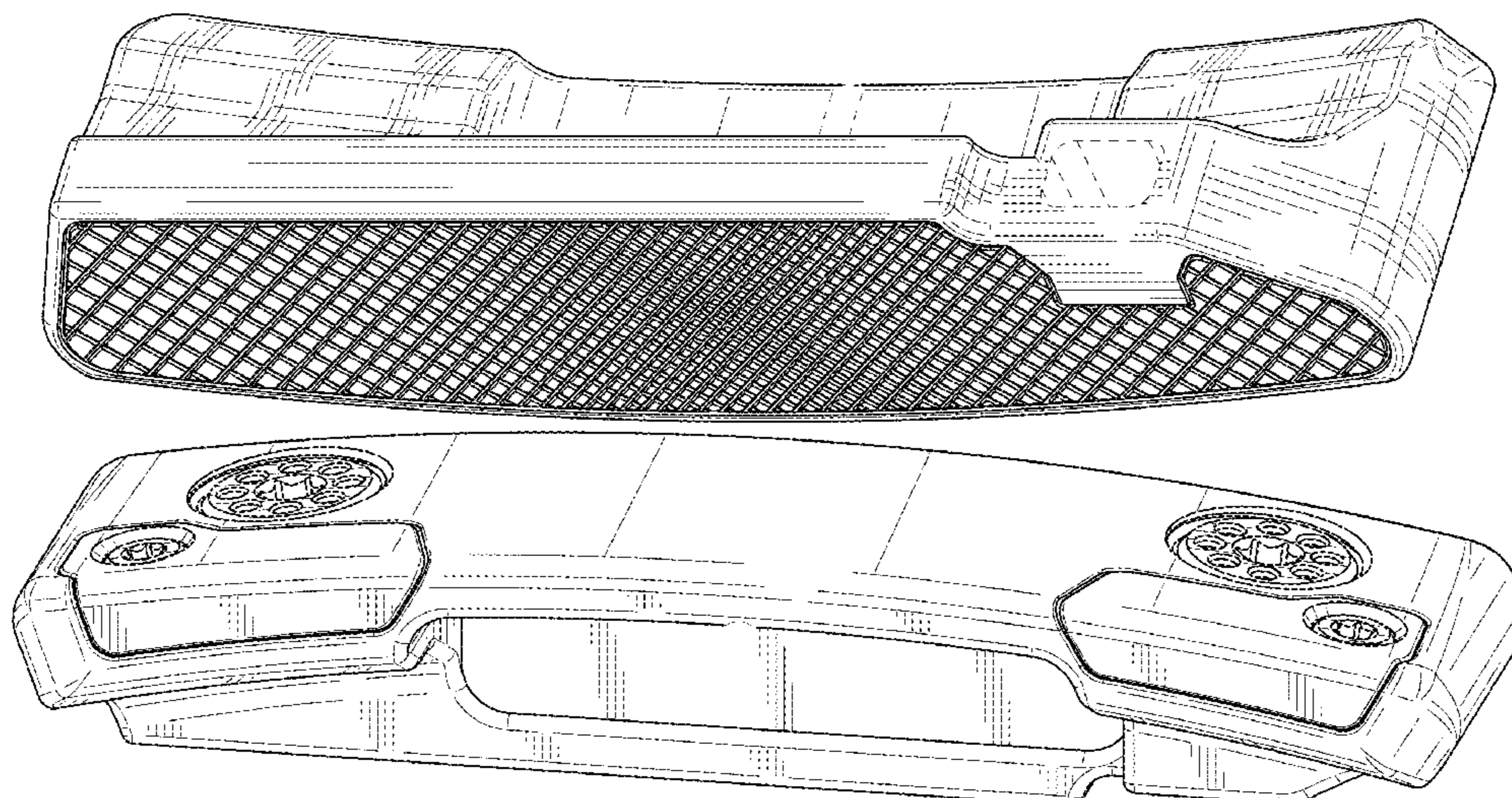

(58) **Field of Classification Search**
 CPC A63B 53/00; A63B 53/04; A63B 53/007;
 A63B 53/065; A63B 53/0487; A63B
 60/00; A63B 60/46
 See application file for complete search history.

(56) **References Cited**

U.S. PATENT DOCUMENTS

1,094,599 A	4/1914	Samson	6,257,994 B1	7/2001	Antonious
D57,980 S	5/1921	Kraeuter	6,264,571 B1	7/2001	Lekavich
D63,284 S	11/1923	Challis	D449,664 S	10/2001	Beebe
RE19,178 E	5/1934	Spiker	D449,865 S	10/2001	Fife, Jr. et al.
4,043,562 A	8/1977	Shillington	D450,799 S	11/2001	Nicolette et al.
D248,783 S	8/1978	Long	D451,973 S	12/2001	Wells et al.
4,340,230 A	7/1982	Churchward	6,348,014 B1	2/2002	Chiu
D281,092 S	10/1985	Mills	6,354,959 B1	3/2002	Nicolette et al.
4,754,977 A	7/1988	Sahm	6,394,910 B1	5/2002	McCarthy
4,869,507 A	9/1989	Sahm	D472,949 S	4/2003	Serrano
4,964,641 A	10/1990	Miesch et al.	D474,821 S	5/2003	Wells et al.
D313,451 S	1/1991	Shearer	D474,949 S	5/2003	Schaffeld et al.
D335,317 S	5/1993	Shearer	D482,087 S	11/2003	Burrows
D335,692 S	5/1993	Antonious	6,652,390 B2	11/2003	Bradford
D336,757 S	6/1993	Antonious	D483,086 S	12/2003	Schweigert et al.
5,275,412 A	1/1994	Innes	D486,539 S	2/2004	Burrows
D344,564 S *	2/1994	Oakleaf D21/739	D486,872 S	2/2004	Schweigert et al.
D350,582 S	9/1994	Miansian et al.	D488,200 S	4/2004	Olsavsky et al.
5,390,919 A	2/1995	Stubbs et al.	D490,487 S	5/2004	Burrows
D356,131 S	3/1995	Trimble	D498,276 S	11/2004	Schweigert et al.
D360,444 S	7/1995	Takahashi et al.	D500,823 S	1/2005	Aldrich
5,429,366 A	7/1995	McCabe	6,902,496 B2	6/2005	Solheim et al.
D363,101 S	10/1995	Sturm	6,902,498 B2	6/2005	Sullivan et al.
D364,665 S	11/1995	Goodrich	D511,801 S	11/2005	Garcia
D365,864 S	1/1996	Sturm	D512,114 S	11/2005	Garcia
5,489,097 A	2/1996	Simmons	D512,116 S	11/2005	Miraflor et al.
D368,751 S	4/1996	Rife	6,988,955 B2	1/2006	Stoakes
D369,393 S	4/1996	Takahashi et al.	6,988,956 B2	1/2006	Cover et al.
5,571,053 A	11/1996	Lane	D520,088 S	5/2006	Parr
D378,688 S	4/1997	Cameron	D531,242 S	10/2006	Adams
D380,514 S	7/1997	Markley	7,125,341 B1	10/2006	D'Eath
D385,609 S	10/1997	Cameron	D532,067 S	11/2006	Soracco et al.
5,683,307 A	11/1997	Rife	7,153,220 B2	12/2006	Lo
D388,143 S	12/1997	Huan-Chiang	D534,595 S	1/2007	Hasebe
D389,207 S	1/1998	Cameron	7,156,752 B1	1/2007	Bennett
D398,685 S	9/1998	Masuda	D536,401 S	2/2007	Kawami
5,807,190 A	9/1998	Krumme et al.	D536,403 S	2/2007	Kawami
D399,290 S	10/1998	Sizemore, Jr.	D537,898 S	3/2007	Kuan et al.
D399,911 S	10/1998	Nicolette et al.	D538,371 S	3/2007	Kawami
5,839,974 A	11/1998	McAllister	7,204,765 B2	4/2007	Cover et al.
D405,836 S	2/1999	Nicolette et al.	D542,869 S	5/2007	Adams
D408,066 S *	4/1999	Gurrola D21/742	D543,598 S	5/2007	Kuan et al.
D409,701 S	5/1999	Ashcraft et al.	D543,601 S	5/2007	Kawami
D411,275 S	6/1999	Bottema et al.	D555,219 S	11/2007	Lin
5,924,938 A	7/1999	Hines	D556,277 S	11/2007	Broom
D415,809 S	10/1999	Bottema et al.	7,309,297 B1	12/2007	Solari
D416,062 S	11/1999	Solheim et al.	D561,854 S	2/2008	Morris
D416,969 S	11/1999	Solheim et al.	7,331,876 B2	2/2008	Klein
D416,970 S	11/1999	Solheim et al.	7,351,162 B2	4/2008	Soracco et al.
6,007,434 A	12/1999	Baker et al.	D569,461 S	5/2008	Morris
D421,473 S	3/2000	Solheim et al.	D569,930 S *	5/2008	Nehrbas D21/744
D422,655 S	4/2000	Hicks	7,396,289 B2	7/2008	Soracco et al.
6,050,903 A	4/2000	Lake	D577,085 S	9/2008	Nicolette et al.
D426,276 S	6/2000	Besnard et al.	D577,086 S	9/2008	Nicolette et al.
6,089,993 A	7/2000	Woodward et al.	D579,506 S	10/2008	Nicolette et al.
D429,302 S	8/2000	Antonious	D579,995 S	11/2008	Nicolette et al.
6,110,057 A	8/2000	McKinnon	D582,497 S	12/2008	Rollinson
D430,914 S	9/2000	Antonious	7,473,189 B2	1/2009	Schweigert et al.
D431,853 S	10/2000	Antonious	7,491,131 B2	2/2009	Vinton
D431,854 S	10/2000	Cameron	D594,921 S	6/2009	Bettinardi
D432,192 S	10/2000	Hicks	D595,793 S	7/2009	Rollinson
D436,151 S	1/2001	Nicolette et al.	D599,425 S	9/2009	Laub
D437,374 S	2/2001	Cameron	D599,867 S	9/2009	Teramoto
D441,820 S	5/2001	Nicolette et al.	D600,763 S	9/2009	Cameron
D443,668 S	6/2001	Nicolette et al.	D601,214 S	9/2009	Serrano et al.
D443,905 S	6/2001	Nicolette et al.	D607,951 S	1/2010	Teramoto
D444,833 S	7/2001	Wells et al.	7,744,485 B2	6/2010	Jones et al.
D444,835 S	7/2001	Wahl et al.	D620,993 S	8/2010	Laub
			D621,461 S	8/2010	Serrano et al.
			D623,709 S	9/2010	Serrano et al.
			D631,925 S *	2/2011	Broom D21/743
			7,887,432 B2	2/2011	Jones et al.
			D633,964 S	3/2011	Teramoto
			7,909,707 B2	3/2011	Klein
			7,918,745 B2	4/2011	Morris et al.
			7,927,226 B1	4/2011	Twitty
			D638,891 S	5/2011	Nicolette et al.
			7,942,758 B2	5/2011	Nakamura
			D639,369 S	6/2011	Miyamichi

(56)

References Cited

U.S. PATENT DOCUMENTS

D642,643 S 8/2011 Nicolette et al.
 D643,485 S 8/2011 Nicolette et al.
 D643,892 S 8/2011 McGrorty
 D645,104 S 9/2011 Nicolette et al.
 8,096,039 B2 1/2012 Soracco et al.
 D653,718 S 2/2012 Stokke et al.
 8,109,841 B2 2/2012 Miyamichi
 D655,361 S 3/2012 Ramsauer
 D661,753 S 6/2012 Cameron et al.
 D666,260 S 8/2012 Cynn
 D672,418 S 12/2012 Rollinson
 8,371,958 B2 2/2013 Treadwell
 8,376,878 B2 2/2013 Bennett et al.
 D688,339 S 8/2013 Hilton et al.
 D688,341 S 8/2013 Rollinson
 D691,226 S 10/2013 Hilton et al.
 8,608,590 B2 12/2013 Hackel et al.
 D699,308 S 2/2014 Rollinson
 8,696,492 B1 4/2014 Hocknell et al.
 D704,782 S 5/2014 Rollinson
 8,721,472 B2 5/2014 Kuan et al.
 8,790,193 B2 7/2014 Serrano et al.
 D711,483 S 8/2014 Wong
 D715,388 S 10/2014 Serrano et al.
 D722,350 S 2/2015 Schweigert
 D722,351 S 2/2015 Parsons et al.
 D722,352 S 2/2015 Nicolette et al.
 D723,120 S 2/2015 Nicolette
 D724,164 S 3/2015 Schweigert et al.
 D725,208 S 3/2015 Schweigert
 D726,265 S 4/2015 Nicolette
 D726,846 S 4/2015 Schweigert
 D730,462 S 5/2015 Becktor et al.
 D732,122 S 6/2015 Becktor
 D732,618 S 6/2015 Becktor et al.
 D733,234 S 6/2015 Nicolette
 D735,283 S 7/2015 Solheim et al.
 9,108,088 B2 8/2015 Serrano et al.
 D738,447 S 9/2015 Schweigert
 D738,449 S 9/2015 Schweigert
 D739,487 S 9/2015 Schweigert
 D741,426 S * 10/2015 Schweigert D21/736
 D746,926 S 1/2016 Parsons et al.
 D748,213 S 1/2016 Parsons et al.
 D748,215 S 1/2016 Parsons et al.
 9,233,283 B2 1/2016 Schweigert
 9,265,996 B1 2/2016 Abbott et al.
 D752,697 S 3/2016 Claveran
 D753,252 S 4/2016 Schweigert
 9,387,375 B2 * 7/2016 Schweigert A63B 53/065
 9,440,124 B2 9/2016 Parsons et al.
 9,498,685 B2 11/2016 Abbott et al.
 D774,151 S * 12/2016 Serrano D21/743
 9,566,484 B1 2/2017 Abbott et al.
 9,649,540 B2 * 5/2017 Parsons A63B 53/0487
 D790,013 S * 6/2017 Clarke D21/743
 D791,891 S 7/2017 Davis
 D794,146 S 8/2017 Davis
 D798,975 S 10/2017 Becktor
 D798,976 S 10/2017 Becktor
 D798,977 S 10/2017 Becktor
 D798,978 S 10/2017 Becktor
 D798,979 S 10/2017 Becktor
 D798,980 S 10/2017 Becktor
 D798,981 S 10/2017 Becktor et al.
 D799,619 S 10/2017 Becktor et al.

D802,073 S 11/2017 Toulon
 D812,163 S 3/2018 Kroloff
 9,987,530 B2 6/2018 Jertson et al.
 10,173,105 B2 1/2019 Myers et al.
 D839,977 S 2/2019 Rollinson et al.
 10,258,844 B2 * 4/2019 Schweigert A63B 53/0487
 10,258,845 B2 * 4/2019 Parsons A63B 53/0487
 10,441,858 B2 * 10/2019 Schweigert A63B 53/065
 10,478,680 B2 * 11/2019 Schweigert A63B 60/02
 10,493,331 B2 * 12/2019 Kroloff A63B 53/0433
 D909,505 S * 2/2021 Schweigert D21/736
 D909,506 S * 2/2021 Schweigert D21/736
 D910,789 S * 2/2021 Schweigert D21/736
 D913,388 S * 3/2021 Nicolette D21/736
 D913,389 S * 3/2021 Schweigert D21/736
 10,960,271 B2 * 3/2021 Kroloff A63B 53/0487
 D920,452 S * 5/2021 Parsons D21/736
 D924,345 S * 7/2021 Nicolette D21/736
 D924,346 S * 7/2021 Nicolette D21/736
 D925,673 S * 7/2021 Parsons D21/736
 D926,898 S * 8/2021 Schweigert D21/736
 D927,619 S * 8/2021 Andrews D21/736
 D928,259 S * 8/2021 Andrews D21/736
 D929,519 S * 8/2021 Agrella D21/744
 D941,945 S * 1/2022 Nicolette D21/736
 2004/0138003 A1 7/2004 Grace
 2004/0180730 A1 9/2004 Franklin et al.
 2006/0052178 A1 3/2006 Franklin et al.
 2006/0094522 A1 5/2006 Tang et al.
 2006/0223649 A1 10/2006 Rife
 2007/0129163 A1 6/2007 Solari
 2007/0135229 A1 6/2007 Lo et al.
 2007/0142122 A1 6/2007 Bonneau
 2007/0207875 A1 9/2007 Kuan et al.
 2007/0238548 A1 10/2007 Johnson
 2008/0139333 A1 6/2008 Klein
 2008/0146372 A1 6/2008 John
 2008/0176672 A1 7/2008 Roach et al.
 2009/0029800 A1 1/2009 Jones et al.
 2010/0255922 A1 10/2010 Lueders
 2011/0165959 A1 7/2011 Klein
 2013/0165256 A1 6/2013 Stevenson
 2013/0210537 A1 8/2013 Ainscough et al.
 2015/0057100 A1 2/2015 Serrano et al.
 2015/0258390 A1 9/2015 DeFrancesco, Jr.
 2015/0306477 A1 * 10/2015 Parsons A63B 60/02
 473/335
 2016/0016050 A1 1/2016 Rife
 2016/0346649 A1 12/2016 Jertson et al.
 2018/0001163 A1 1/2018 Becktor et al.
 2018/0311545 A1 11/2018 Lambeth et al.

FOREIGN PATENT DOCUMENTS

KR 200377377 Y1 3/2005
 KR 200403045 Y1 12/2005
 KR 20100065481 A 6/2010
 KR 101773069 B1 8/2017

OTHER PUBLICATIONS

TourSpecGolf (Gold's Factory Multi Weighted Custom Putter), Published Nov. 20, 2010 [http://blog.tourSpecgolf.com/golds-factory-multi-weighted-custom-putter/], Retrieved May 17, 2020.
 U.S. Appl. No. 29/523,587, Schweigert "Golf Club Head," filed Apr. 10, 2015.

* cited by examiner

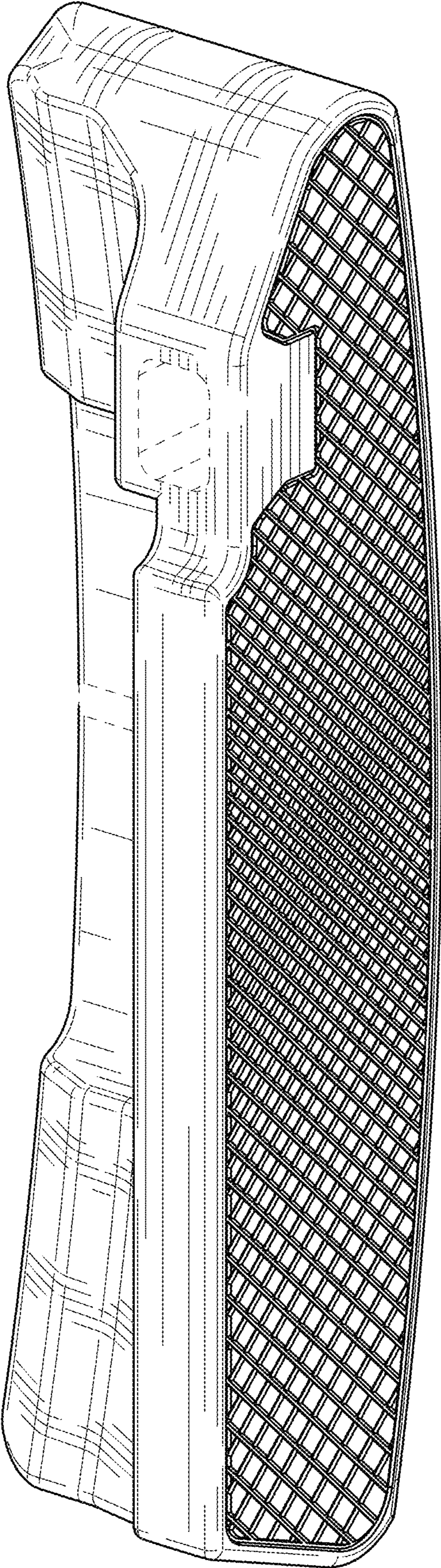

FIG. 1

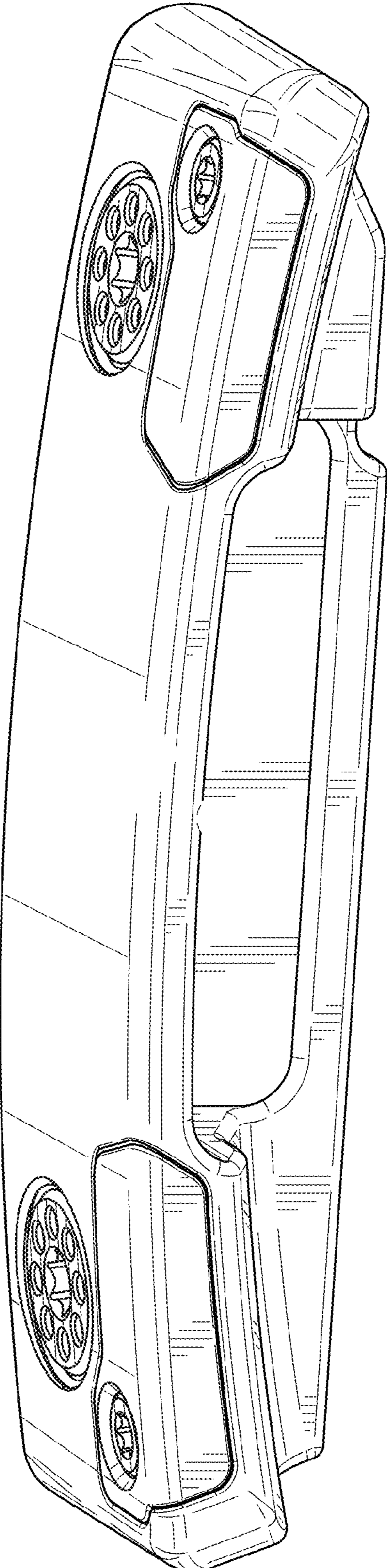

FIG. 2

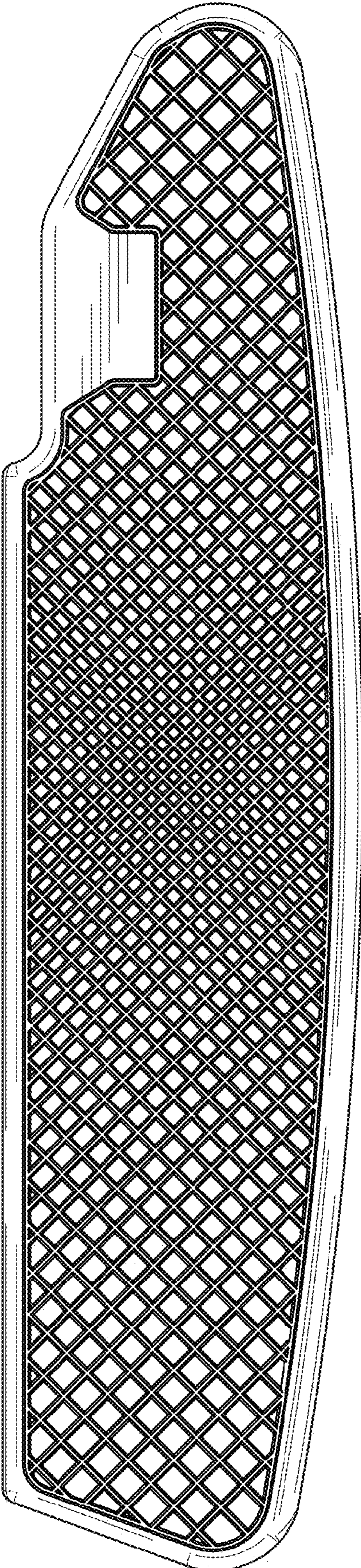

FIG. 3

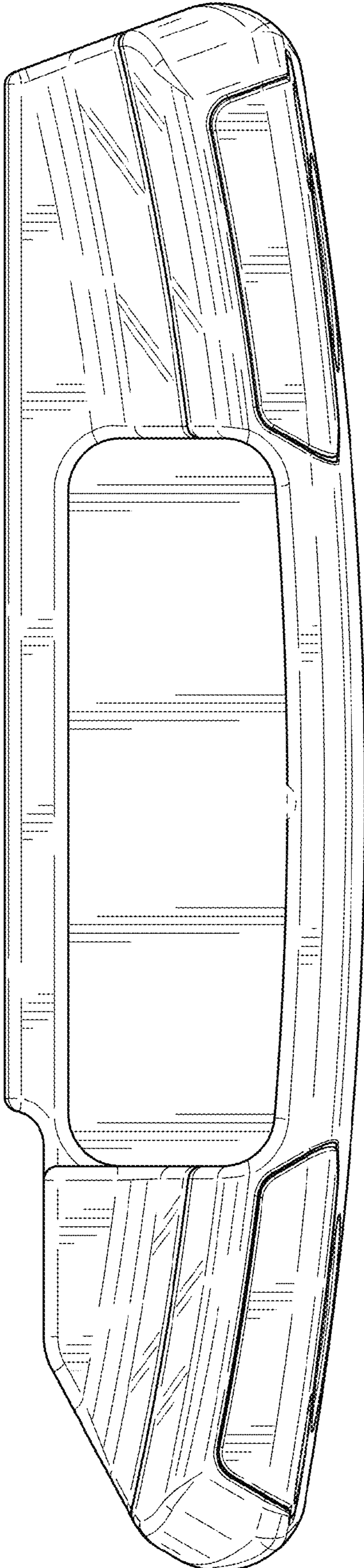

FIG. 4

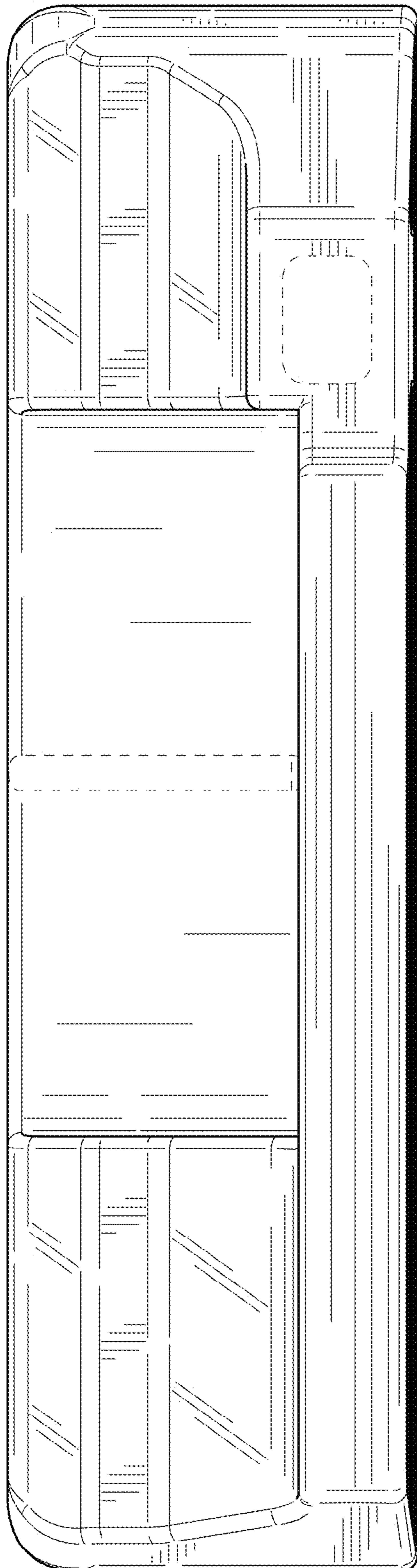

FIG. 5

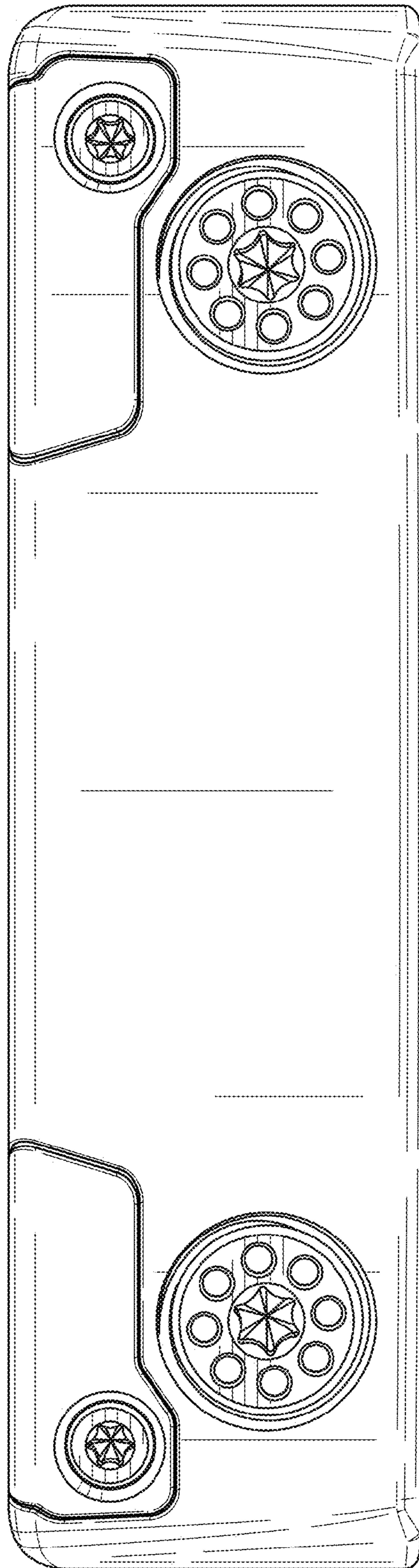

FIG. 6

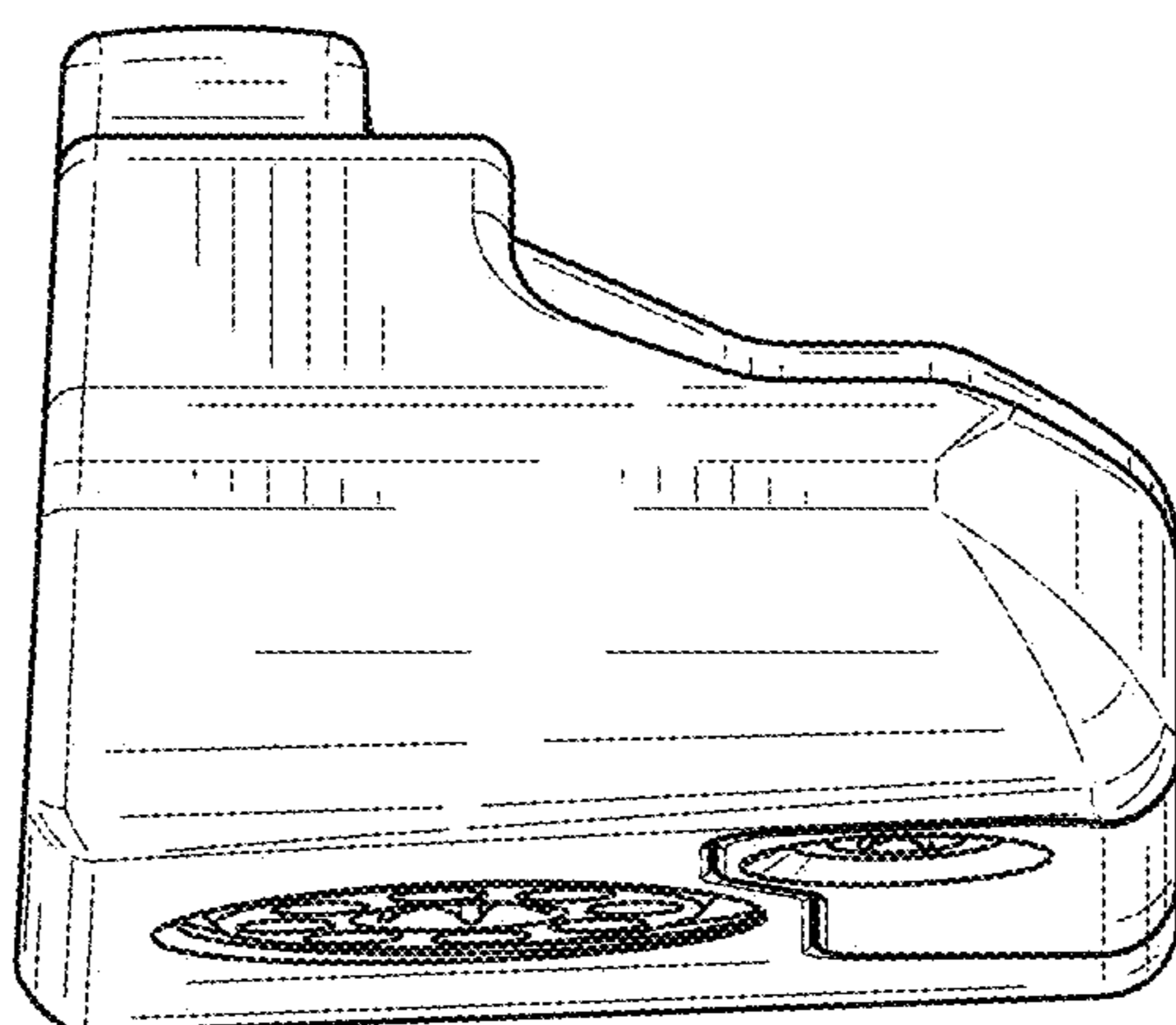

FIG. 7

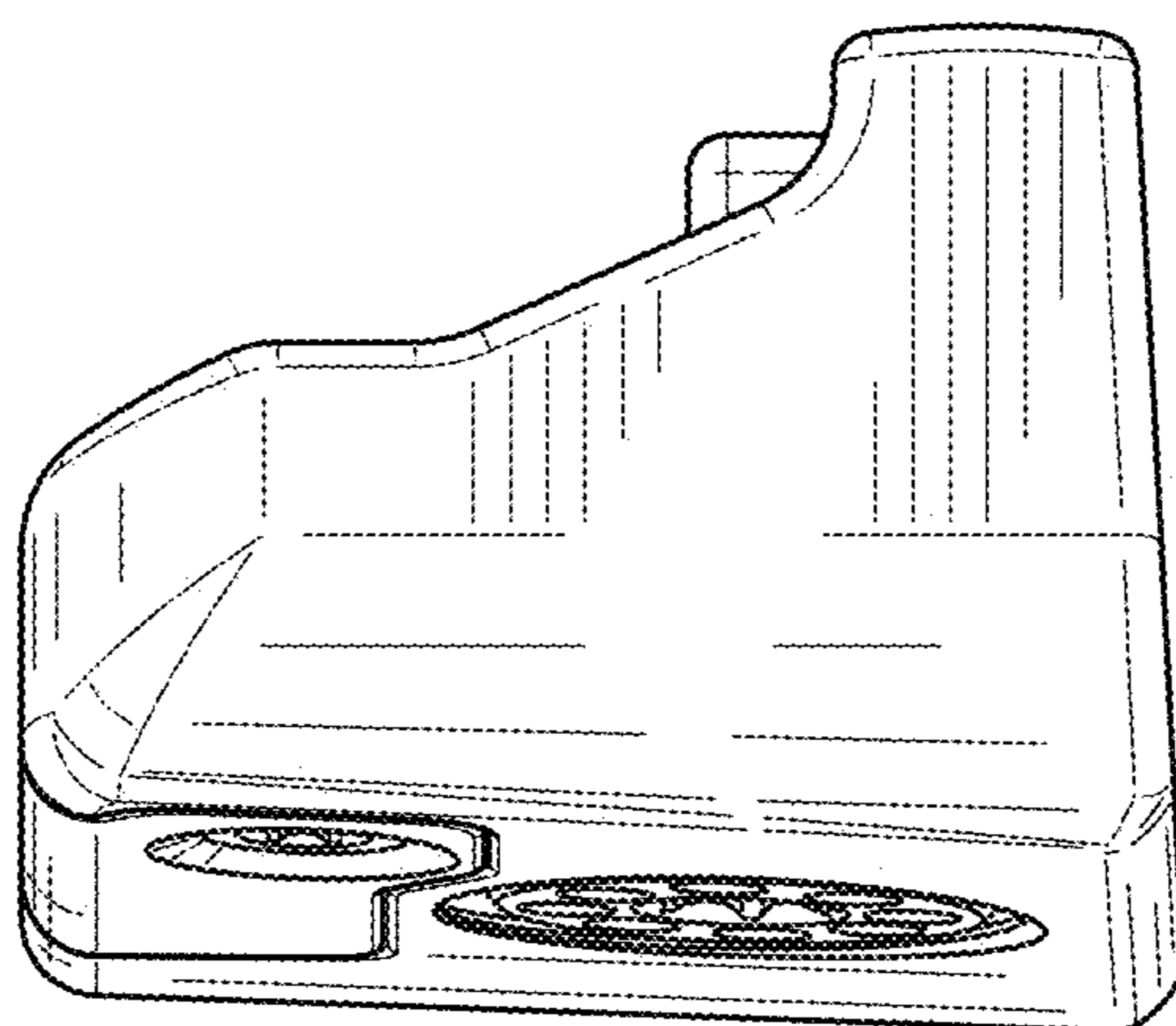

FIG. 8

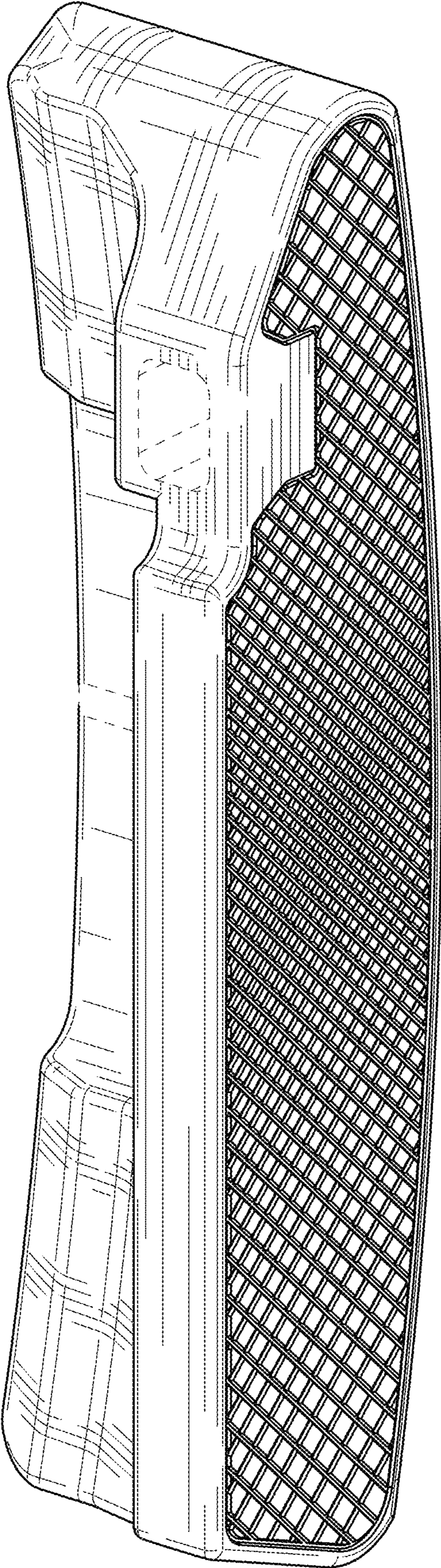

FIG. 9

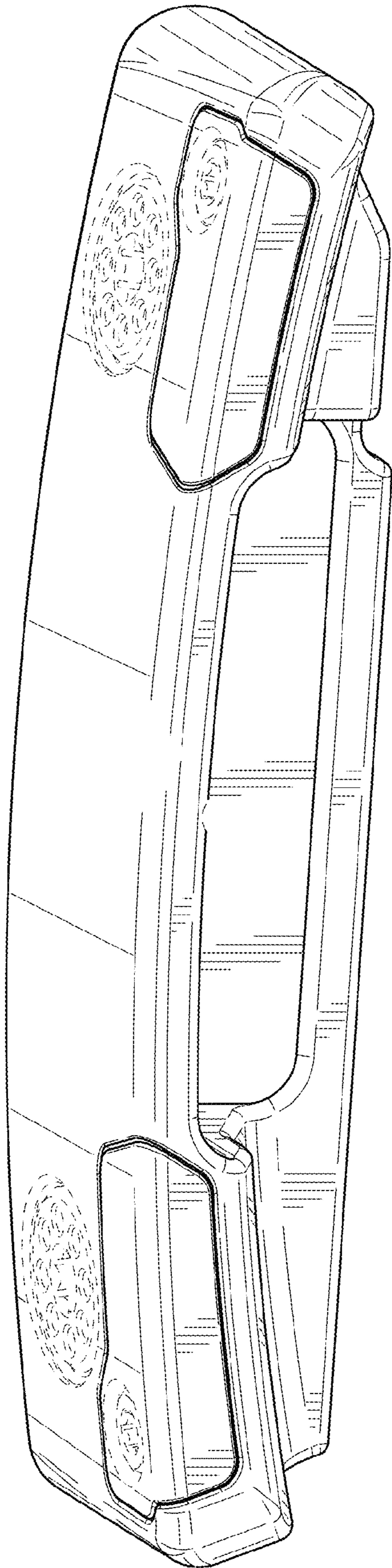

FIG. 10

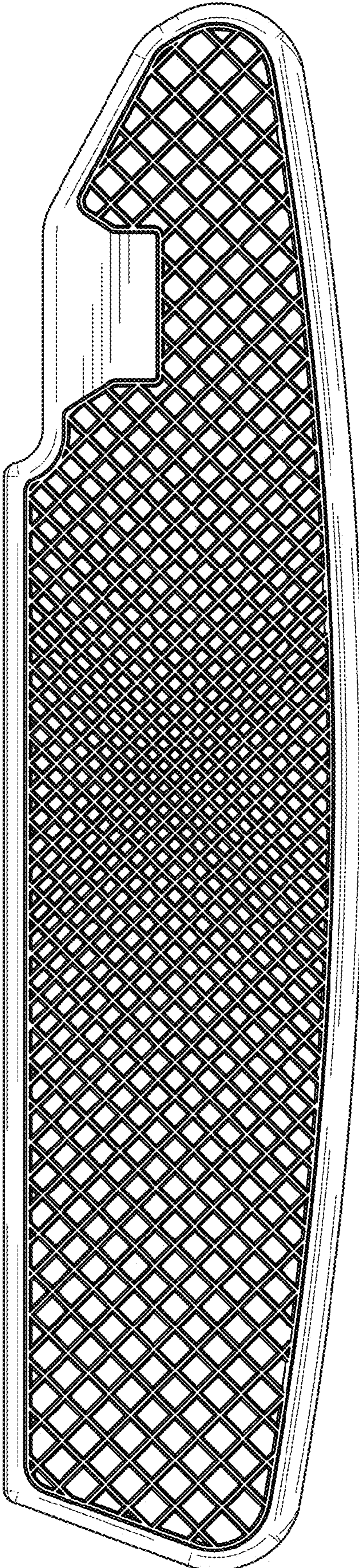

FIG. 11

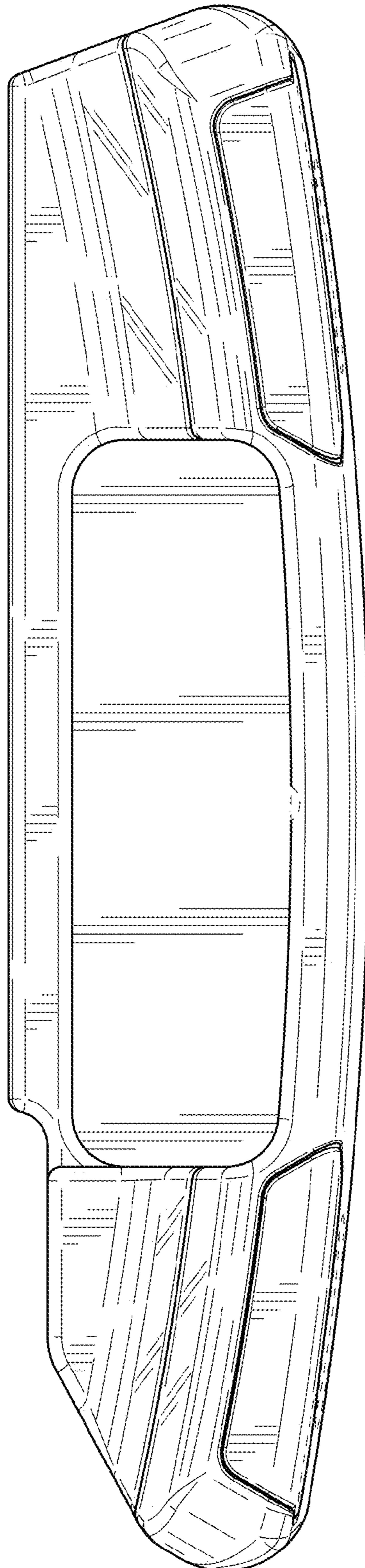

FIG. 12

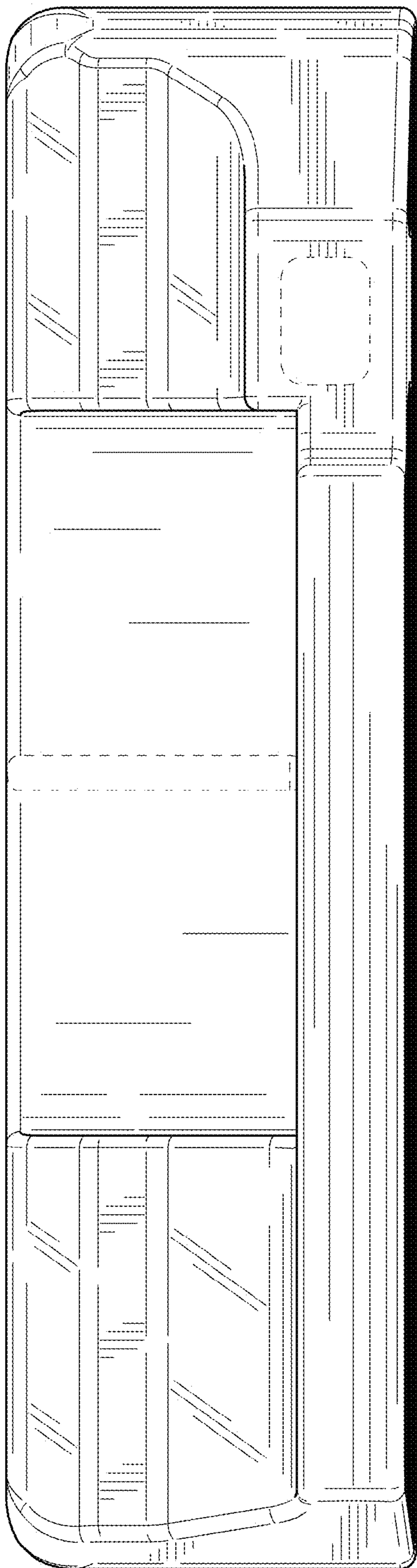

FIG. 13

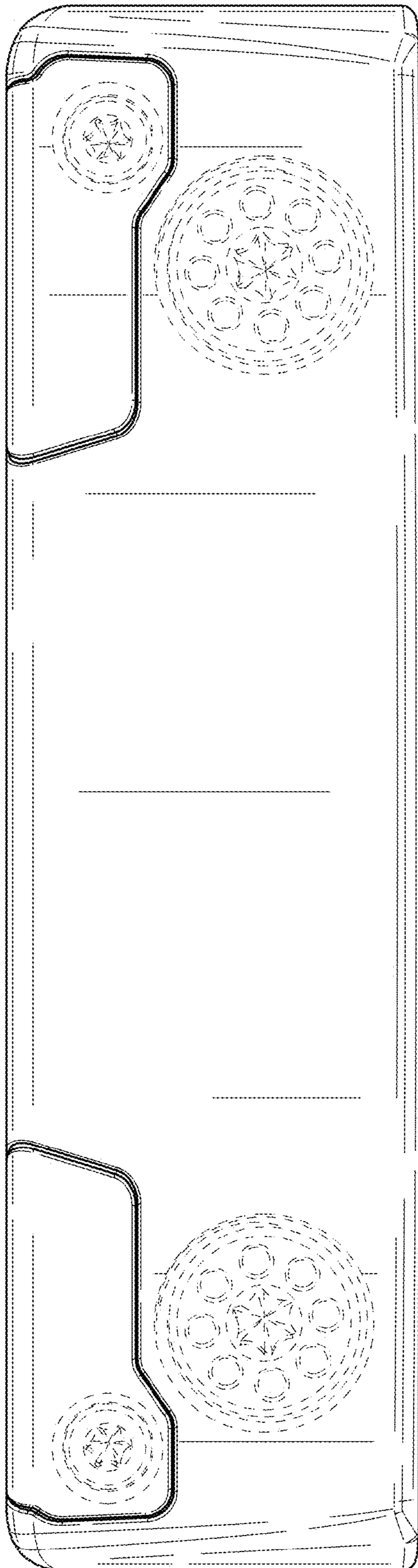

FIG. 14

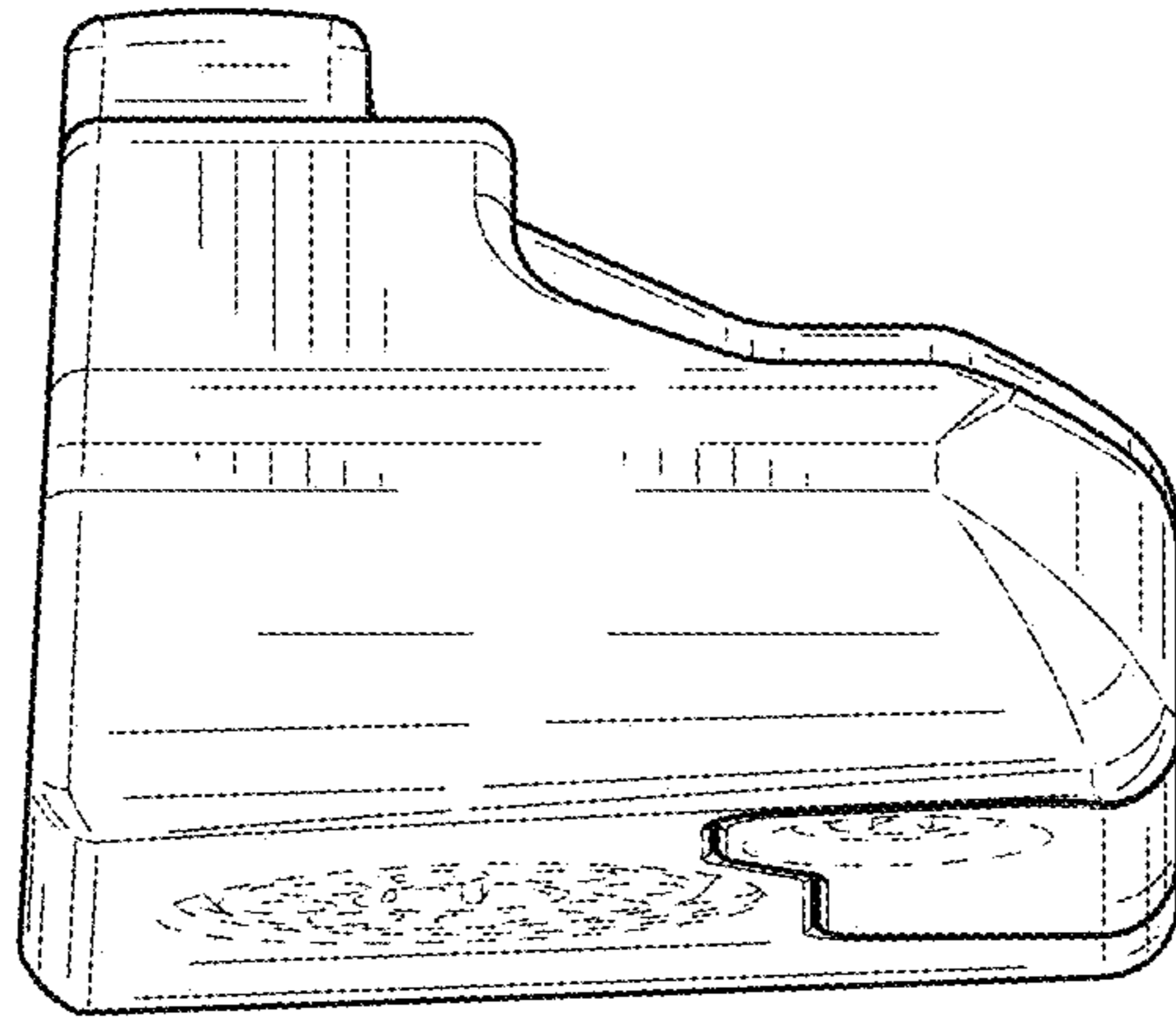

FIG. 15

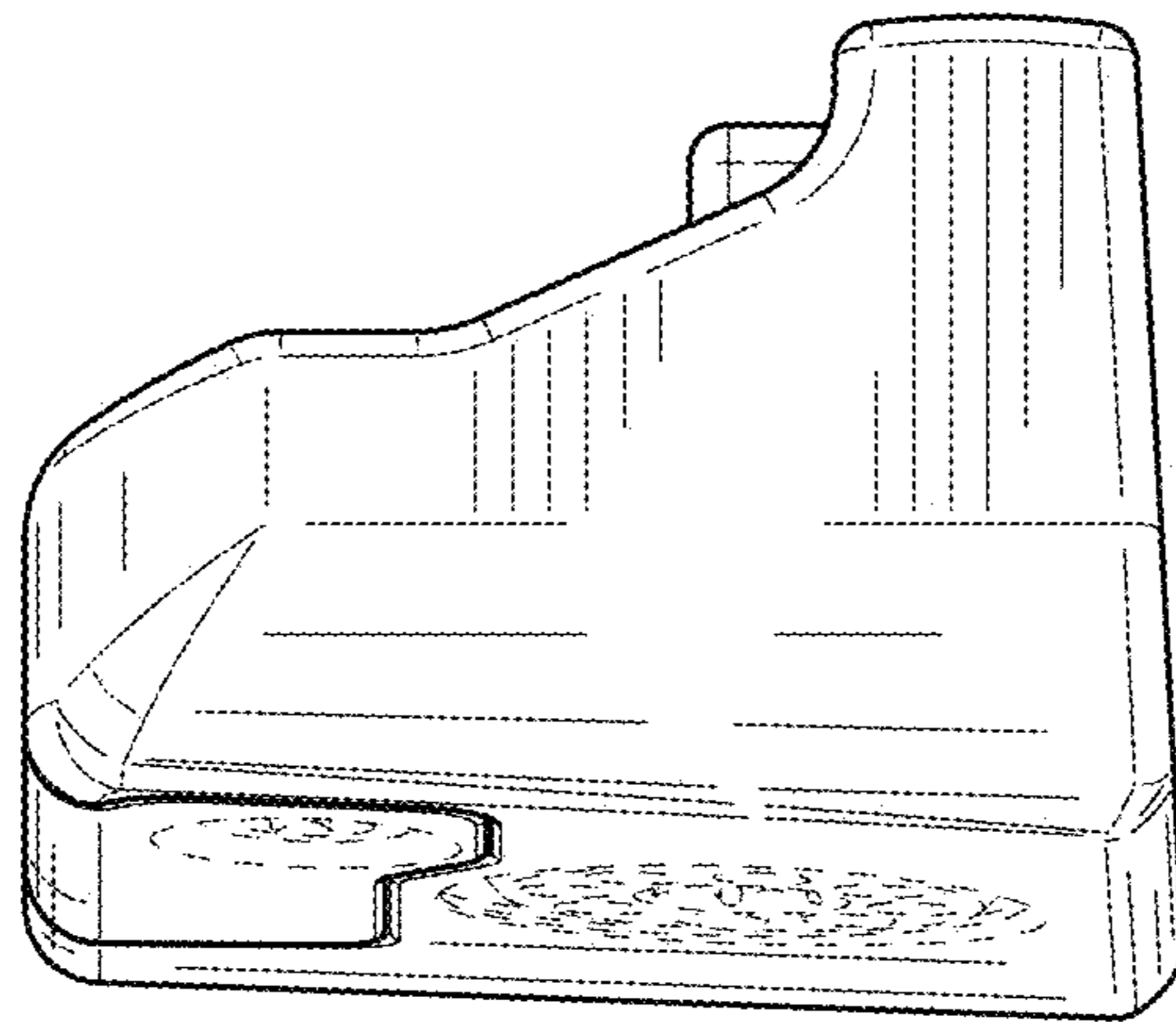

FIG. 16

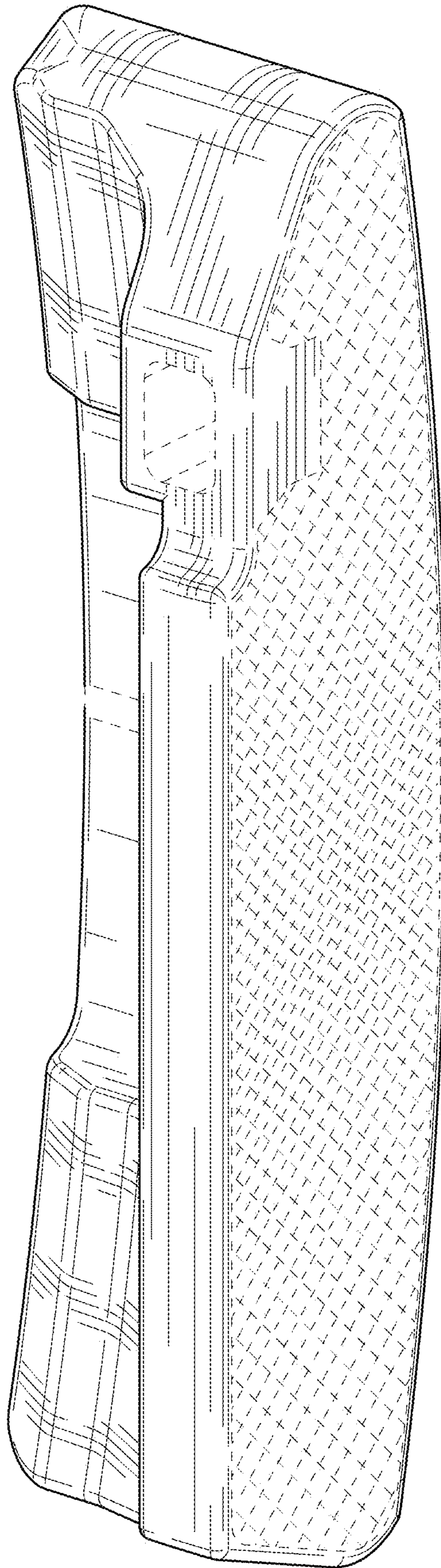

FIG. 17

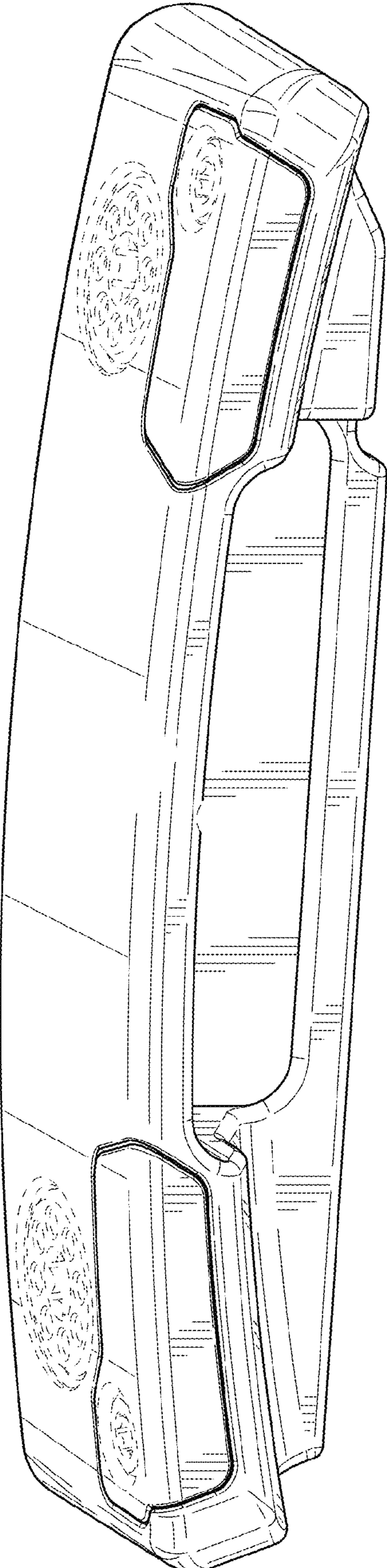

FIG. 18

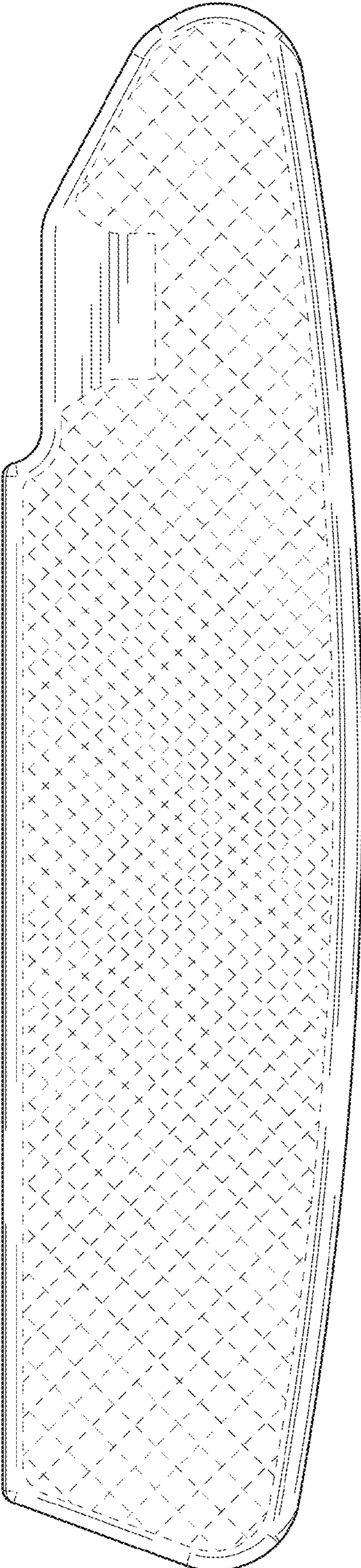

FIG. 19

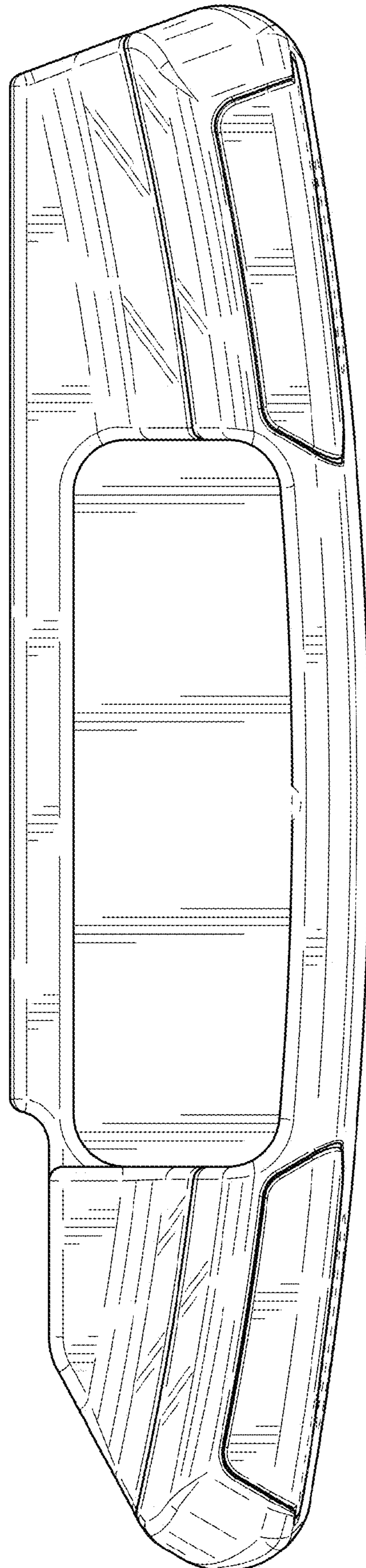

FIG. 20

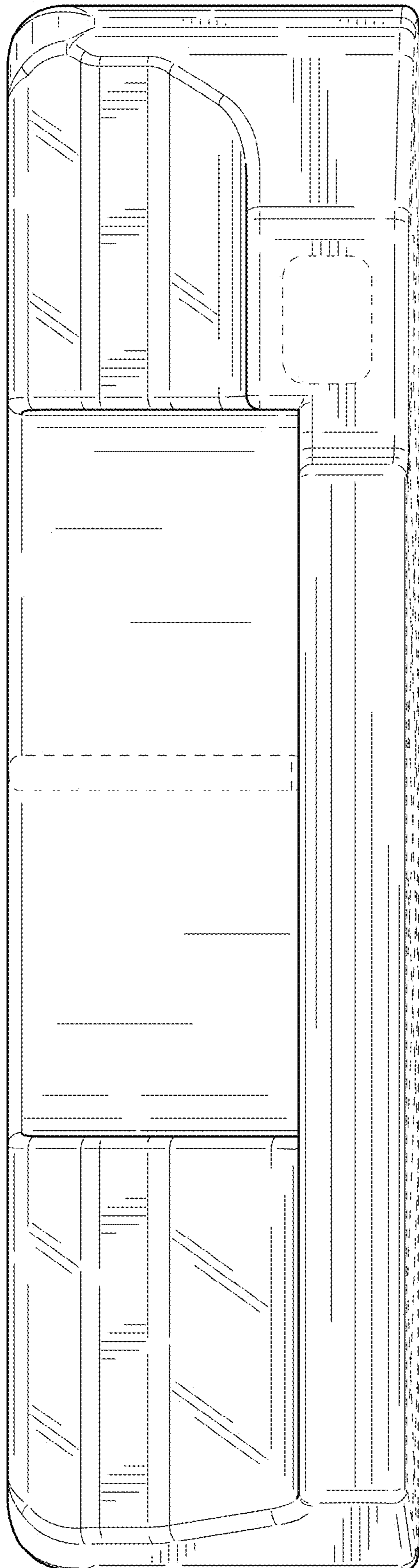

FIG. 21

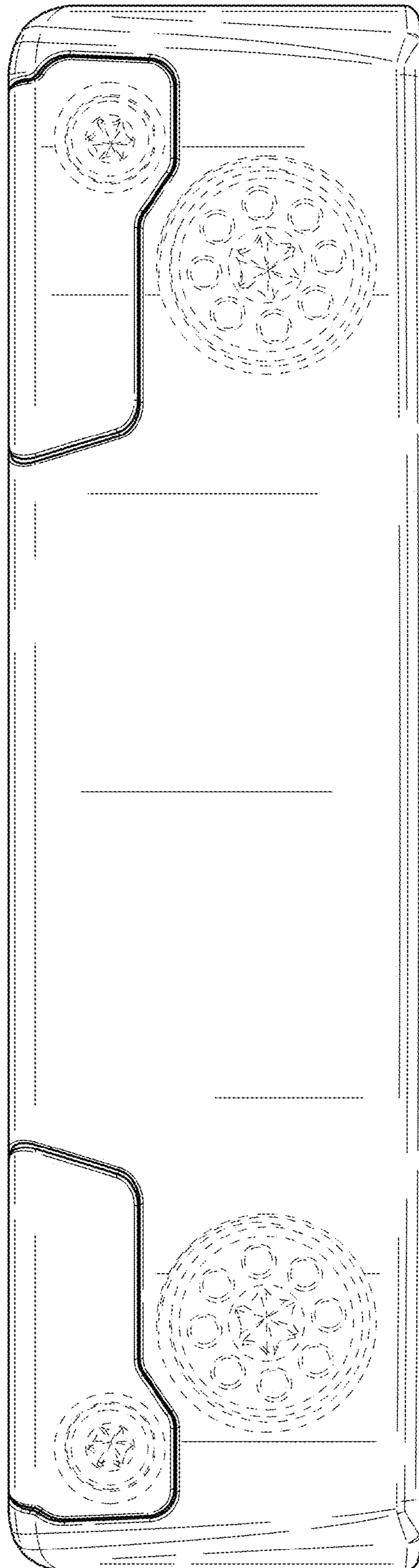

FIG. 22

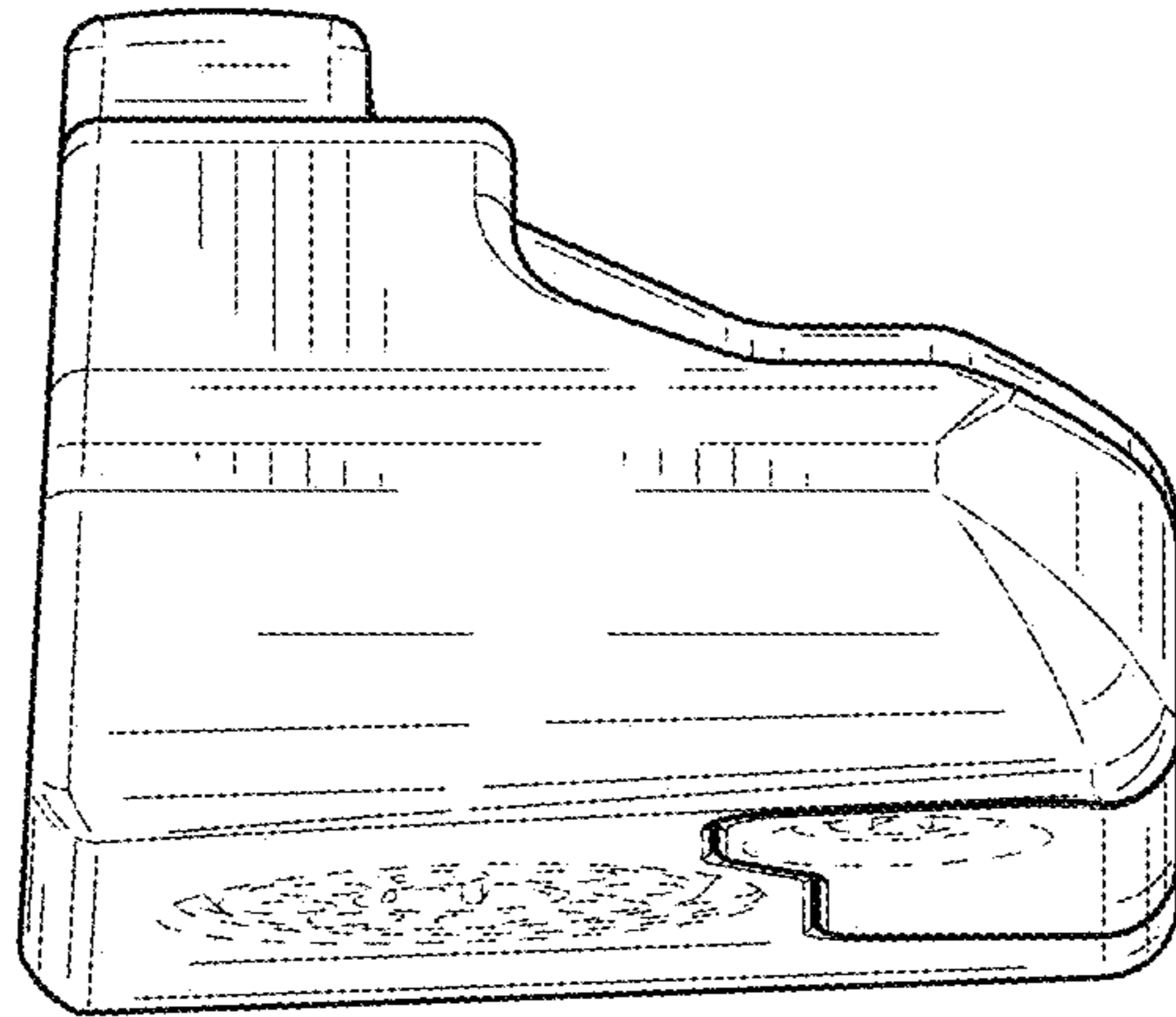

FIG. 23

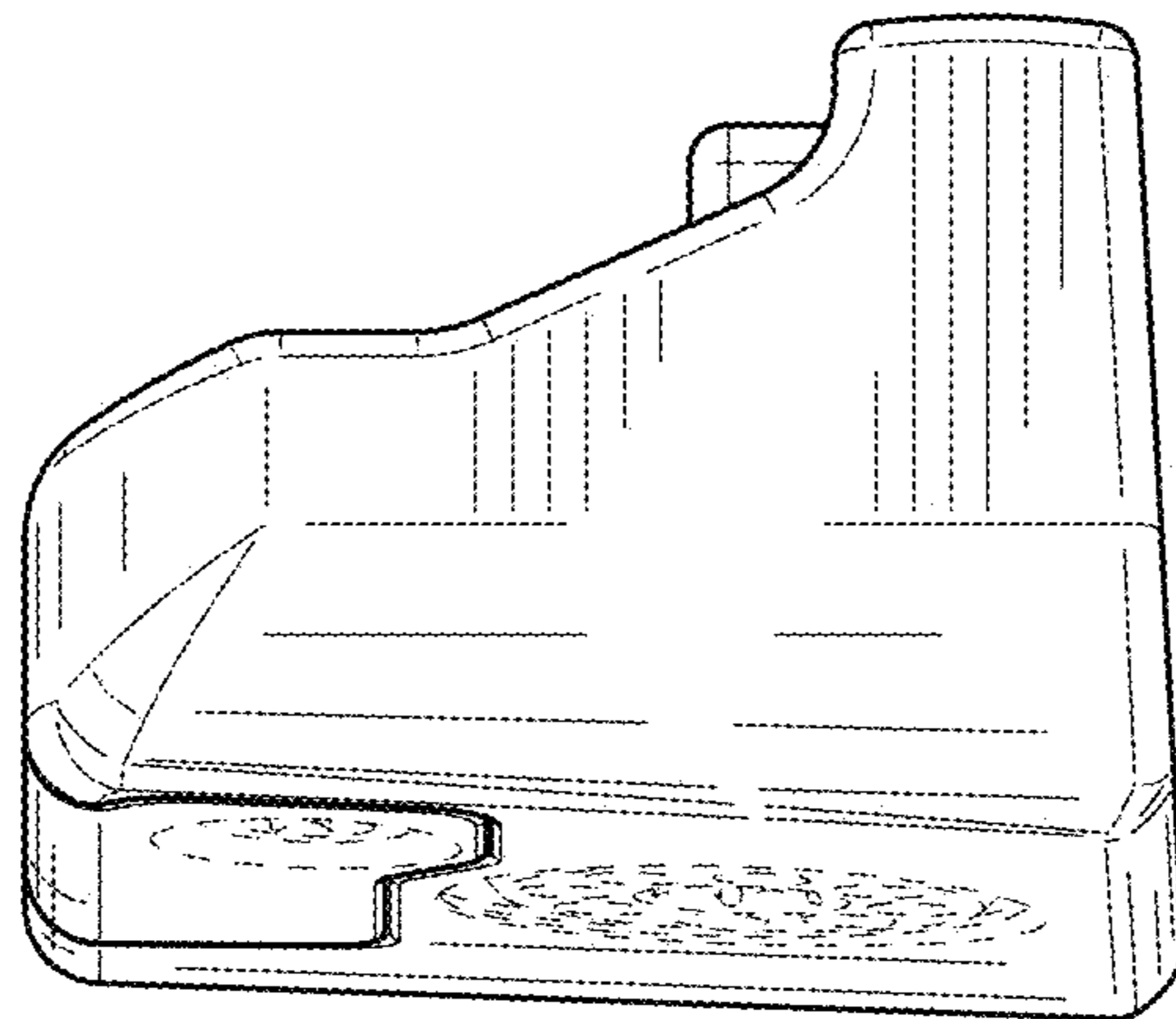

FIG. 24