



US00D951372S

(12) **United States Design Patent**  
**Wang**

(10) **Patent No.:** **US D951,372 S**

(45) **Date of Patent:** **\*\* May 10, 2022**

(54) **DUMBBELL**

(71) Applicant: **JINAN JUNSHUO FITNESS EQUIPMENT CO., LTD.**, Jinan (CN)

(72) Inventor: **Limin Wang**, Jinan (CN)

(73) Assignee: **JINAN JUNSHUO FITNESS EQUIPMENT CO., LTD.**, Jinan (CN)

(\*\*) Term: **15 Years**

(21) Appl. No.: **29/797,505**

(22) Filed: **Jun. 30, 2021**

(51) **LOC (13) Cl.** ..... **21-02**

(52) **U.S. Cl.**  
USPC ..... **D21/680**

(58) **Field of Classification Search**  
USPC ..... D21/675, 680, 681, 677, 683, 684, 685  
See application file for complete search history.

(56) **References Cited**

**U.S. PATENT DOCUMENTS**

D597,612 S *	8/2009	Lien	.....	D21/681
D685,441 S *	7/2013	Januszek	.....	D21/681
D692,072 S *	10/2013	Childs	.....	D21/681
D799,980 S *	10/2017	Michan Chavez	.....	D9/600
D851,712 S	6/2019	Jones et al.		
D857,811 S	8/2019	Hendrickson et al.		
D920,449 S *	5/2021	Wang	.....	D21/681

D936,762 S *	11/2021	Ye	.....	D21/680
2009/0131232 A1 *	5/2009	Chen	.....	A63B 21/0728 482/104
2014/0005012 A1 *	1/2014	Wang	.....	A63B 21/0726 482/108

**OTHER PUBLICATIONS**

Northdeer, announced May 2021[online], [site visited Mar. 9, 2022]. Available on internet, URL:https://www.amazon.com/Northdeer-Adjustable-Dumbbells-Exercise-Standard-Finish/dp/B094XV2VN5/ref (Year: 2021).\*

\* cited by examiner

*Primary Examiner* — Khawaja Anwar

*Assistant Examiner* — Julice Seung Eun Oum

(57) **CLAIM**

The ornamental design for a dumbbell, as shown and described.

**DESCRIPTION**

FIG. 1 is a perspective view of a dumbbell showing my new design;  
FIG. 2 is another perspective view thereof;  
FIG. 3 is a front elevational view thereof;  
FIG. 4 is a rear elevational view thereof;  
FIG. 5 is a left side elevational view thereof;  
FIG. 6 is a right side elevational view thereof;  
FIG. 7 is a top plan view thereof;  
FIG. 8 is a bottom plan view thereof; and,  
FIG. 9 is an enlarged view of portion 9 shown in FIG. 1.

**1 Claim, 9 Drawing Sheets**

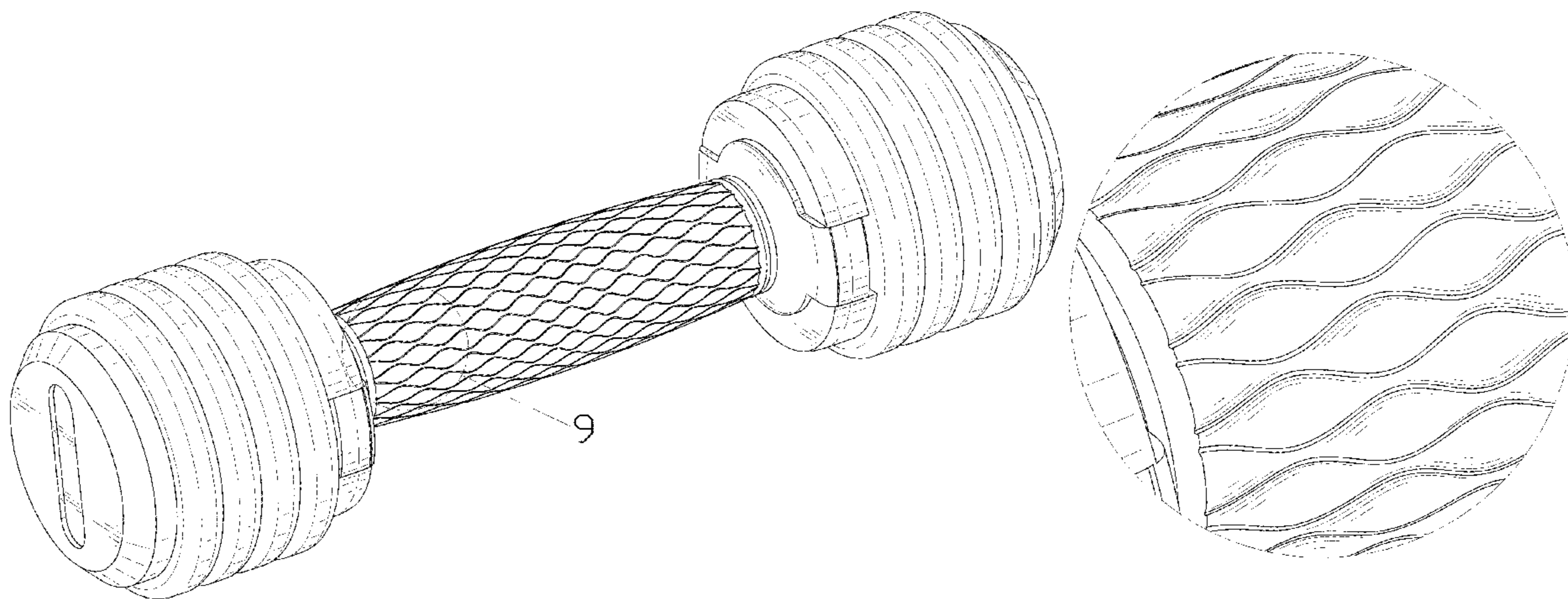

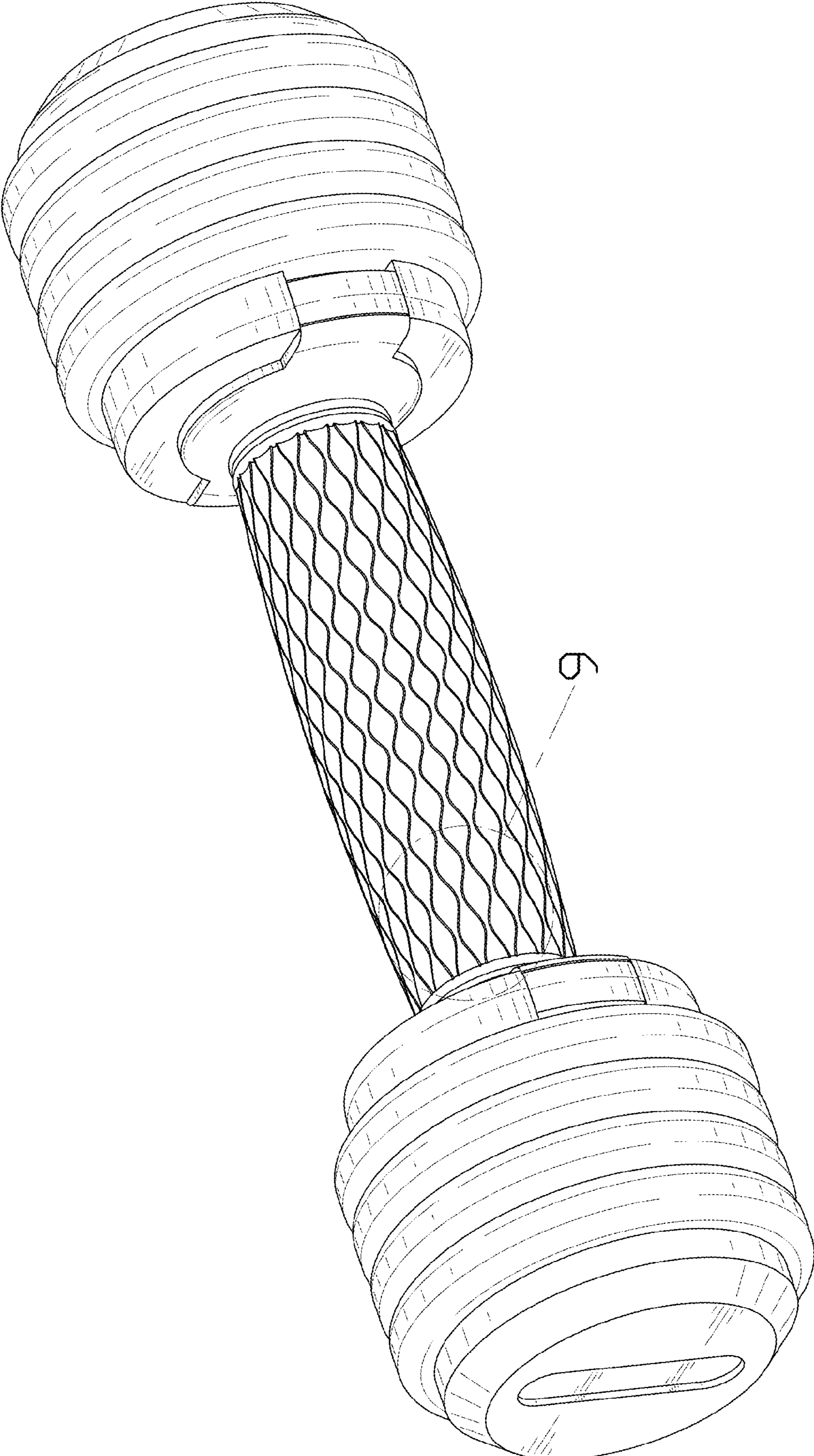

FIG. 1

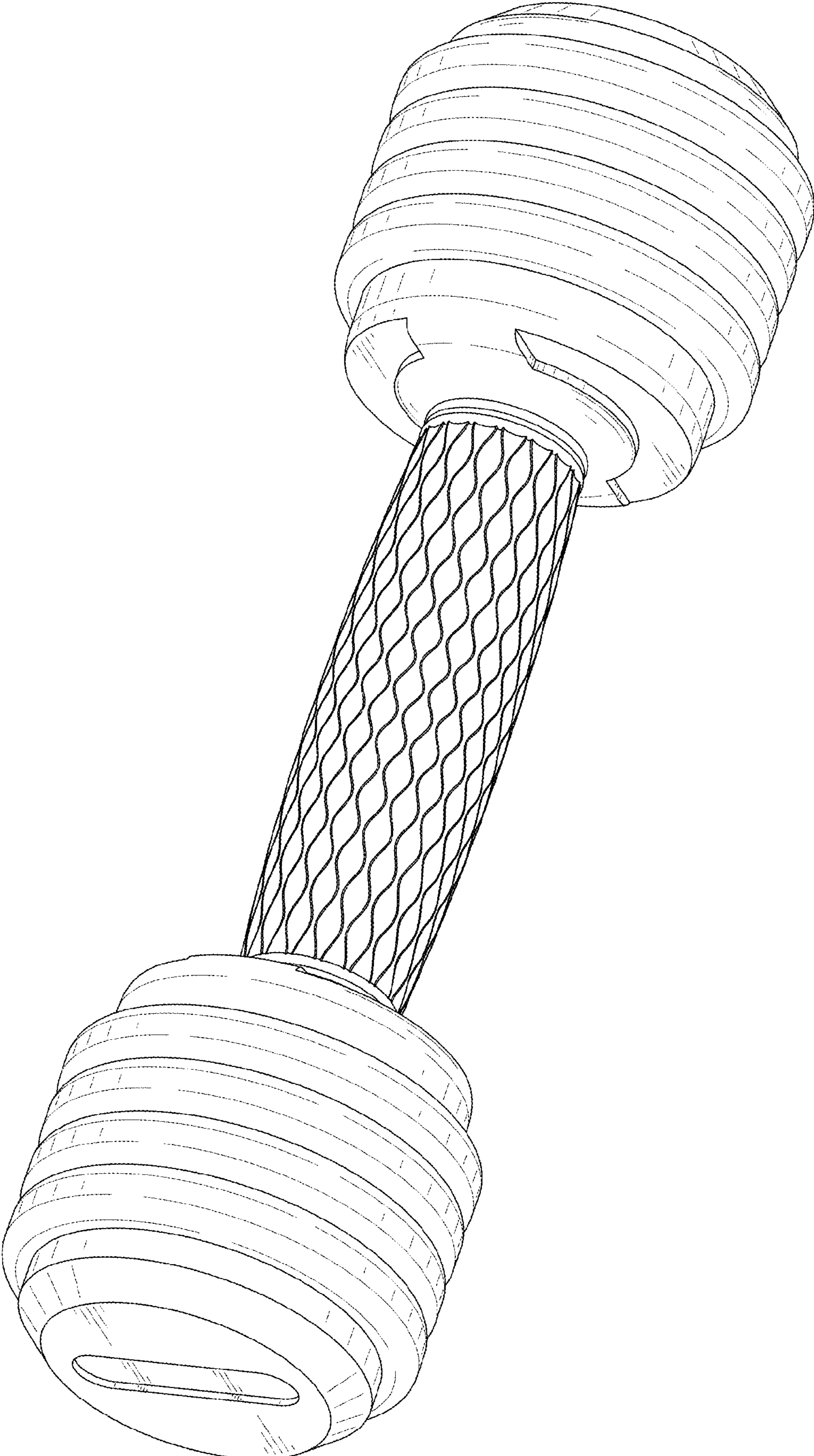

FIG. 2

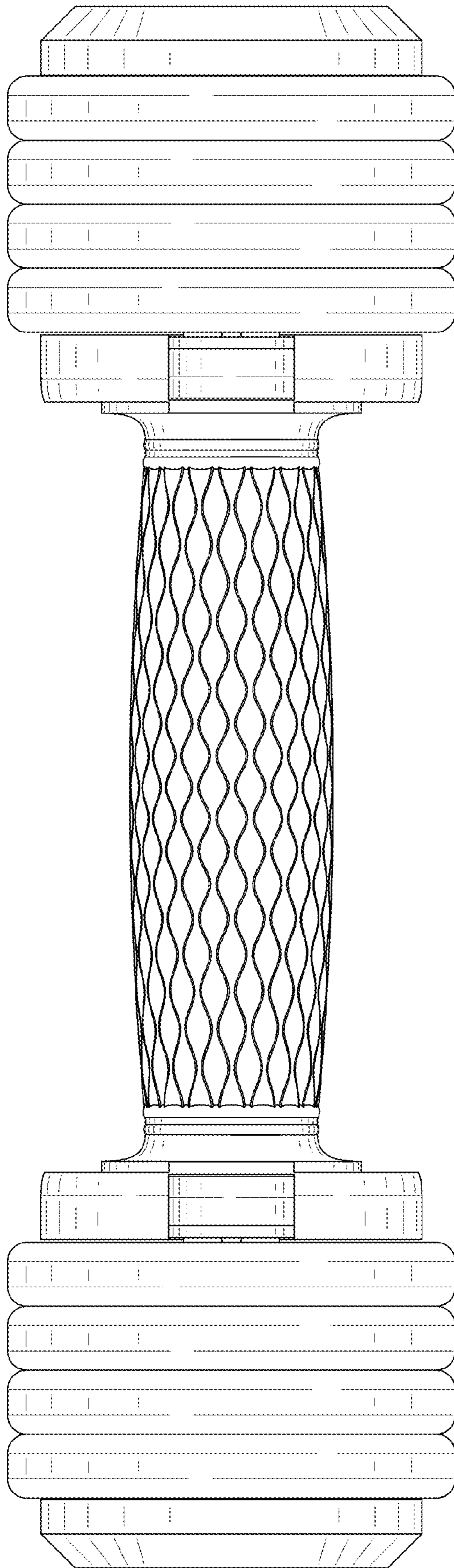

FIG. 3

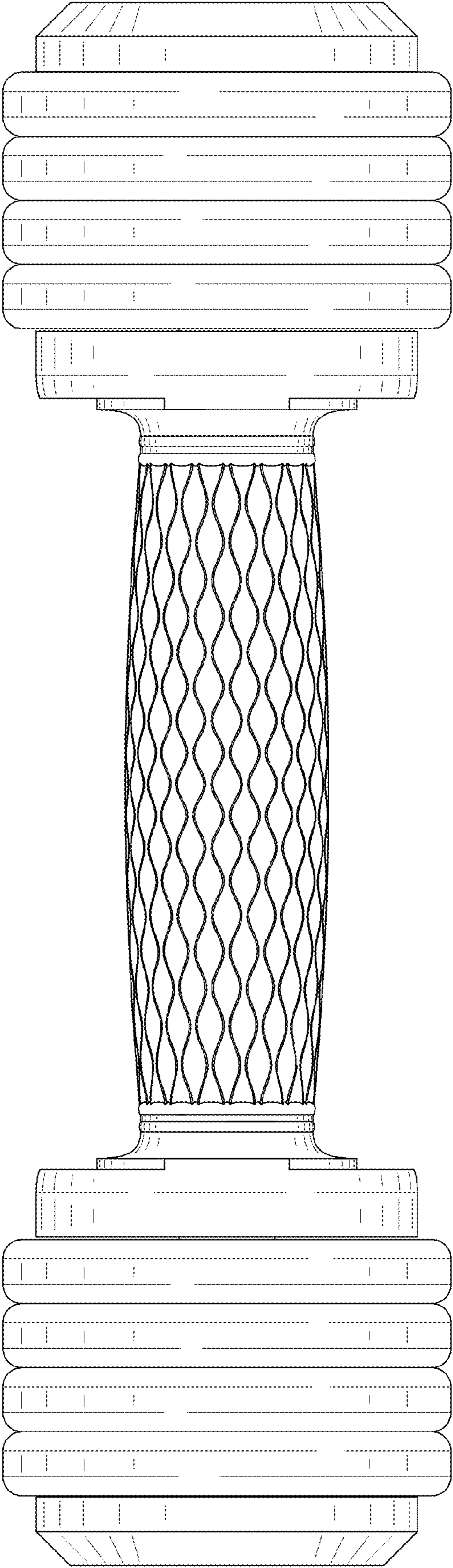

FIG. 4

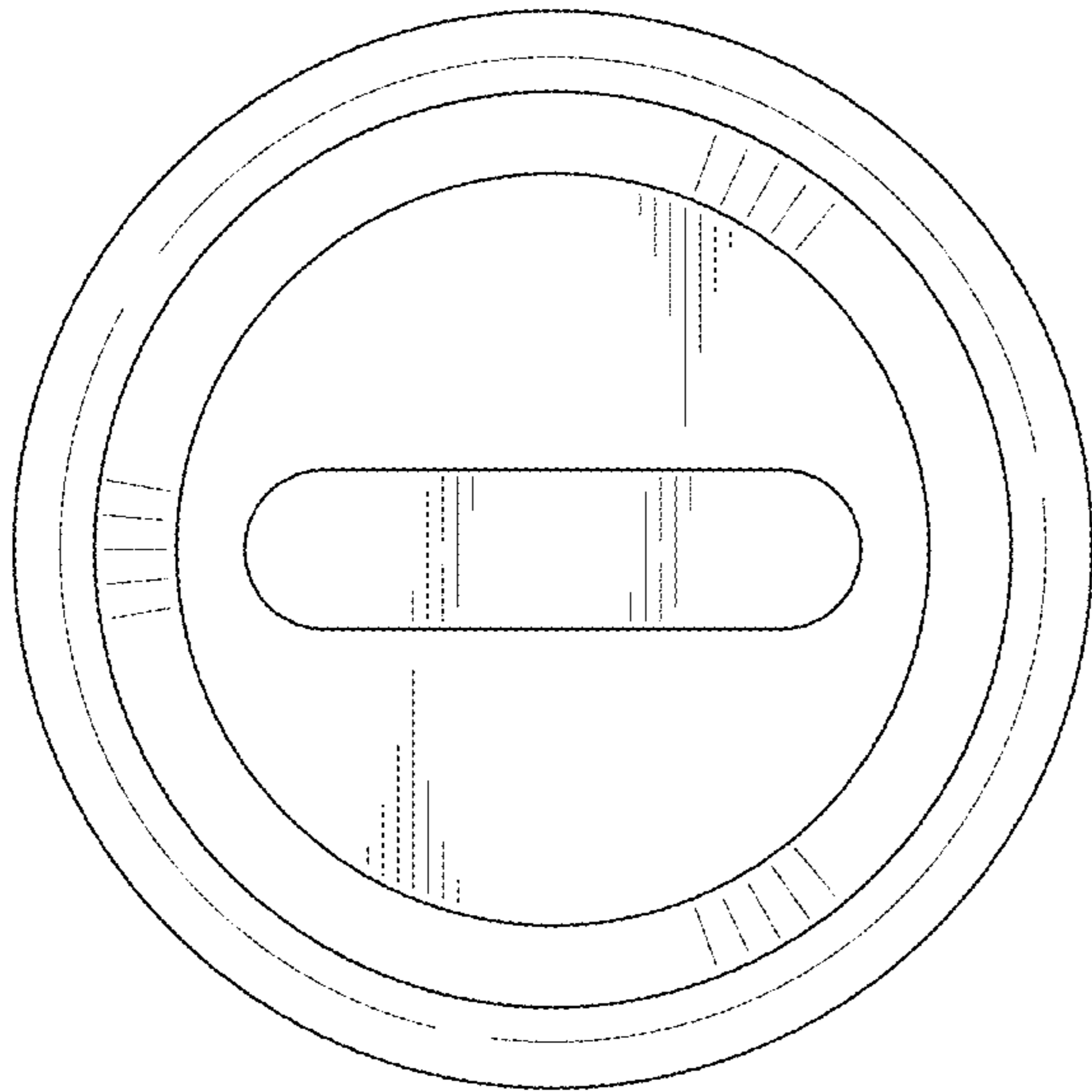

FIG. 5

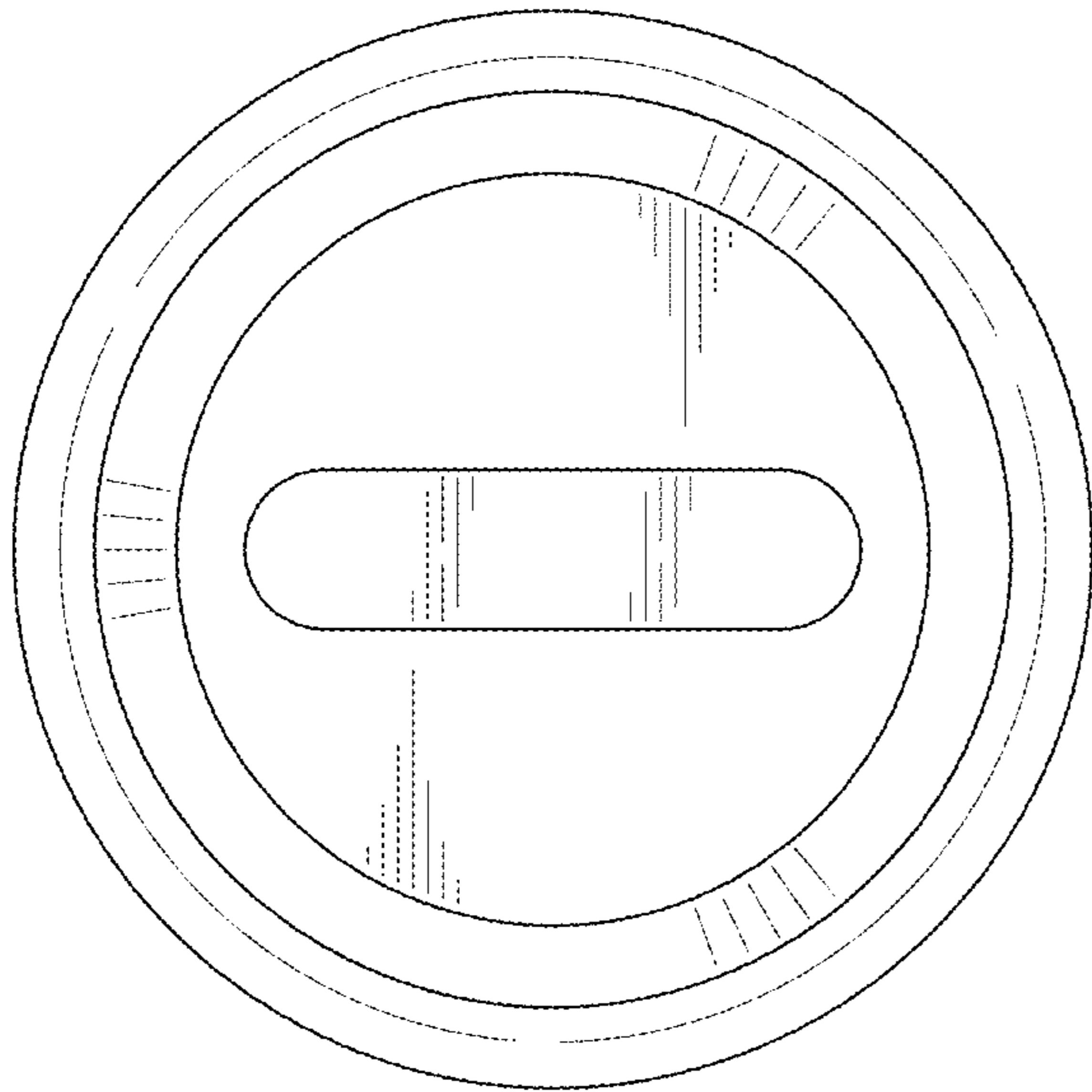

FIG. 6

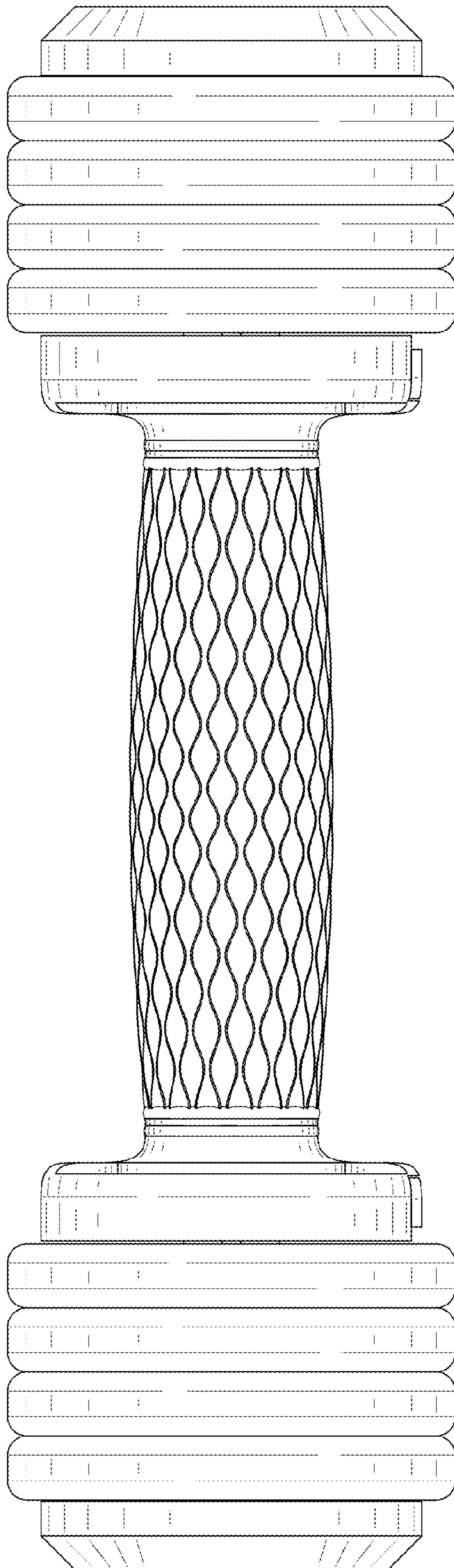

FIG. 7



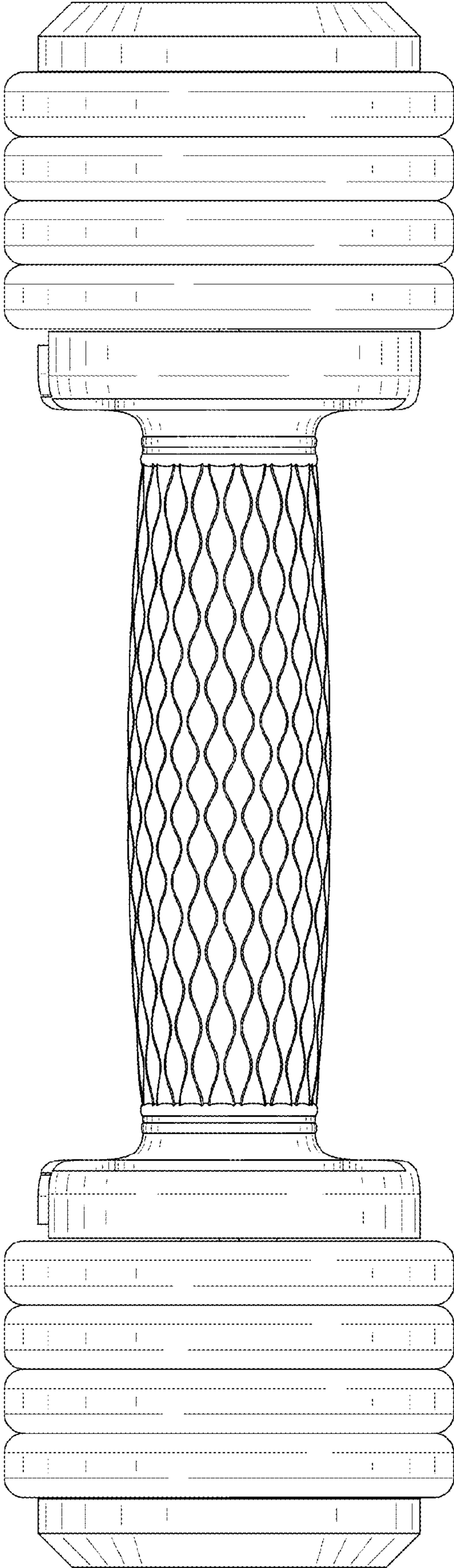

FIG. 8

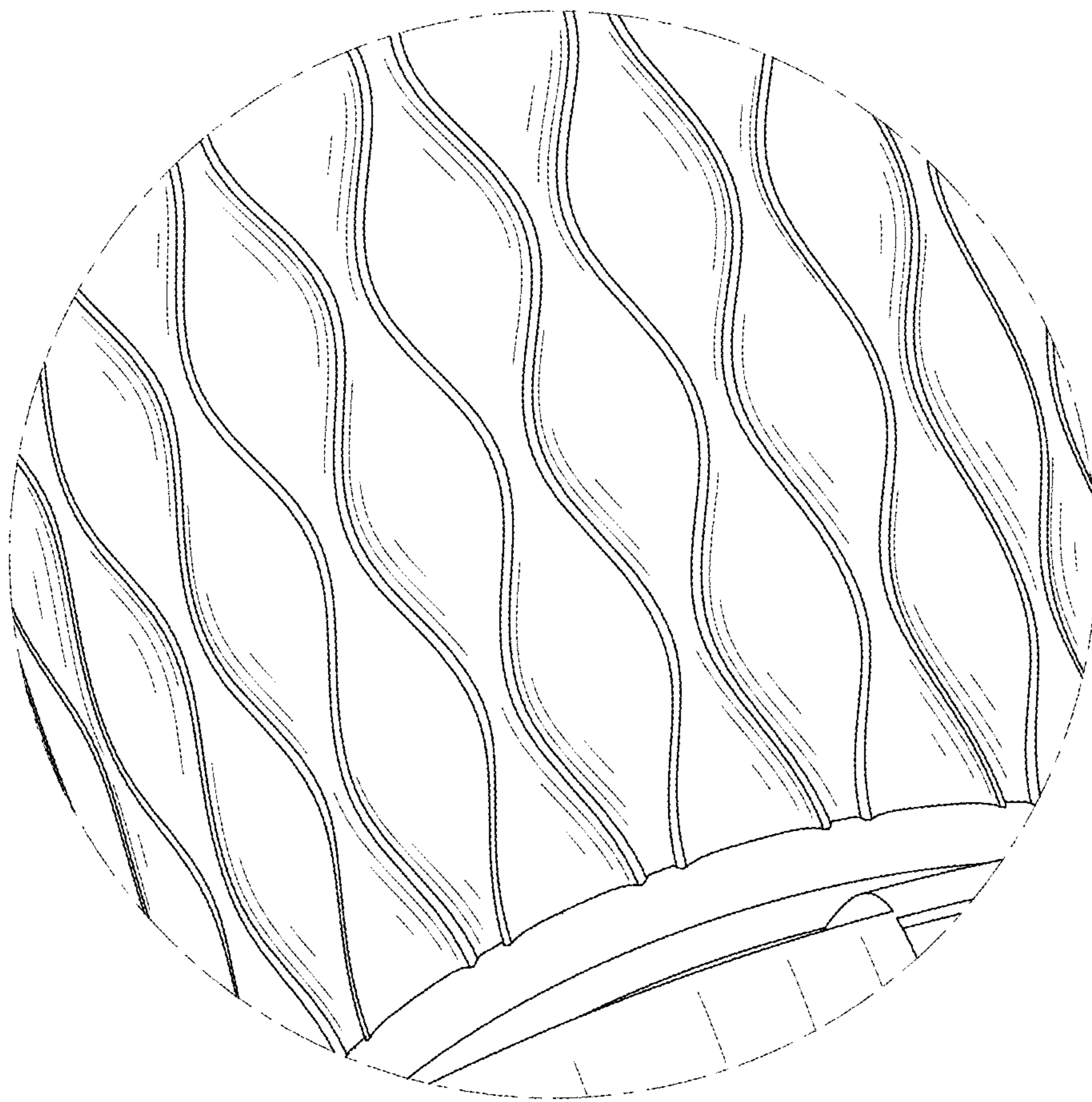

FIG. 9