



US00D951311S

(12) **United States Design Patent** (10) **Patent No.:** **US D951,311 S**
Lee et al. (45) **Date of Patent:** **** May 10, 2022**

(54) **DOOR WITH REFRIGERATOR AND DELIVERY STORAGE BOX**

F25D 23/062; F25D 23/067; F25D 2400/18; F25D 23/08; F25D 23/085; F25D 2500/02; F25D 25/00; F25D 25/005; F25D 25/022; F25D 25/024; F25D 17/047; F25D 2317/041; F25D 2317/04131;

(71) Applicant: **LG ELECTRONICS INC.**, Seoul (KR)

(72) Inventors: **Junghoon Lee**, Seoul (KR); **Hyunchul Kim**, Seoul (KR); **Insun Yeo**, Seoul (KR); **Wook Shin**, Seoul (KR); **Kiyeal Seo**, Seoul (KR); **Eugene Myung**, Seoul (KR)

(Continued)

(56) **References Cited**

U.S. PATENT DOCUMENTS

2,404,851 A * 7/1946 Knowles F25D 25/025
312/286
2,421,439 A * 6/1947 Smith F25D 13/02
62/382
3,089,313 A * 5/1963 Fix F25D 13/02
62/239

(Continued)

Primary Examiner — Richard E Chilcot

(74) *Attorney, Agent, or Firm* — Birch, Stewart, Kolasch & Birch, LLP

(73) Assignee: **LG ELECTRONICS INC.**, Seoul (KR)

(**) Term: **15 Years**

(21) Appl. No.: **35/510,357**

(22) Filed: **Mar. 16, 2020**

(80) **Hague Agreement Data**

Int. Filing Date: **Mar. 16, 2020**
Int. Reg. No.: **DM/207486**
Int. Reg. Date: **Mar. 16, 2020**
Int. Reg. Pub. Date: **Sep. 18, 2020**

(57) **CLAIM**

The ornamental design for a door with refrigerator and delivery storage box, as shown and described.

DESCRIPTION

(30) **Foreign Application Priority Data**

Oct. 2, 2019 (KR) 30-2019-0047432

(51) **LOC (13) Cl.** **15-07**

(52) **U.S. Cl.**
USPC **D15/91**
CPC **F25D 25/025** (2013.01)

(58) **Field of Classification Search**

USPC D15/79-91; 312/112-119, 236, 352, 312/400-408; 62/3.1, 3.6, 3.63, 3.64, 62/293, 31, 371, 400, 467, 529, 531
CPC F25D 25/025; F25D 23/028; F25D 2323/024; F25D 23/00; F25D 23/02; F25D 2323/021; F25D 23/065; F25D 11/00; F25D 2201/14; F25D 23/021; F25D 23/025; F25D 23/04; F25D 27/00;

1. Door with refrigerator and delivery storage box
1.1 : Perspective
1.2 : Front
1.3 : Back
1.4 : Left
1.5 : Right
1.6 : Top
1.7 : Bottom
1.8 : Perspective view showing the refrigerator door open
1.9 : Perspective view showing the delivery door open
1.10 : Perspective view showing the main door open
The diagonal shading lines in the reproductions are used to show the translucent material of the claimed design, and do not represent its surface ornamentation. The broken lines

(Continued)

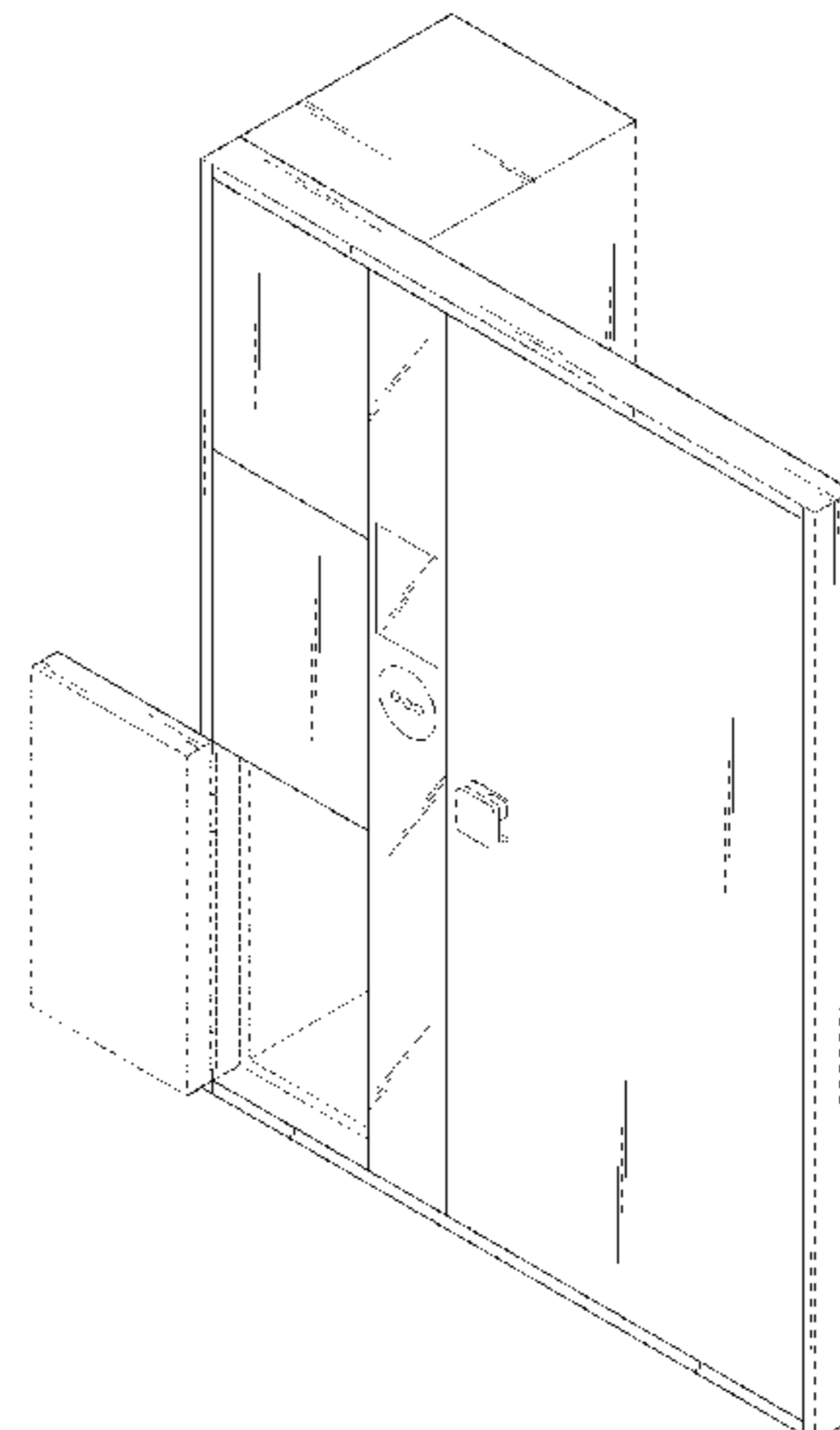

shown in reproductions **1.8-1.10** depict portions of the door with refrigerator and delivery storage box that form no part of the claimed design.

1 Claim, 10 Drawing Sheets

(58) Field of Classification Search

CPC F25D 2317/1043; F25D 2317/0664; F25D 2321/147; F25D 2323/02; F25D 2323/023
See application file for complete search history.

(56) References Cited

U.S. PATENT DOCUMENTS

5,474,213 A * 12/1995 Unger F25C 5/22
222/108
D443,625 S * 6/2001 Vazquez D15/86
D471,568 S * 3/2003 Smith D15/85
D544,000 S * 6/2007 Ohtake D15/81
D669,103 S * 10/2012 Behr D15/91
D671,573 S * 11/2012 Behr D15/91
8,496,308 B2 * 7/2013 Zabbatino G06Q 30/0645
312/407
8,814,286 B2 * 8/2014 Ward F25D 25/024
312/404

D880,543 S * 4/2020 Luchetta D15/91
D905,766 S * 12/2020 Vernon D15/79
D918,055 S * 5/2021 Smith, Jr. D9/636
D924,278 S * 7/2021 Choi F25D 25/025
D15/79
2003/0005716 A1 * 1/2003 Doran F25D 23/10
62/263
2006/0179724 A1 * 8/2006 Lee A47G 29/141
52/79.1
2008/0036238 A1 * 2/2008 Weeda B60P 3/20
296/146.1
2008/0278335 A1 * 11/2008 Welte G07C 9/28
340/573.3
2009/0236954 A1 * 9/2009 Kobayashi A47F 3/0404
312/36
2010/0256800 A1 * 10/2010 Heffron G07F 11/62
700/214
2012/0206029 A1 * 8/2012 Zabbatino F25D 23/025
312/404
2012/0209763 A1 * 8/2012 Zabbatino G06Q 30/0645
705/39
2017/0061373 A1 * 3/2017 Hara A47G 29/141
2017/0188542 A1 * 7/2017 Dix A01K 1/035
2017/0286905 A1 * 10/2017 Richardson G06Q 10/0832
2018/0172337 A1 * 6/2018 Choi F25D 23/02
2019/0257556 A1 * 8/2019 Pinet A47F 3/0434
2019/0271500 A1 * 9/2019 Lee F25D 23/02
2021/0217261 A1 * 7/2021 Green G08C 17/02

* cited by examiner

1.1

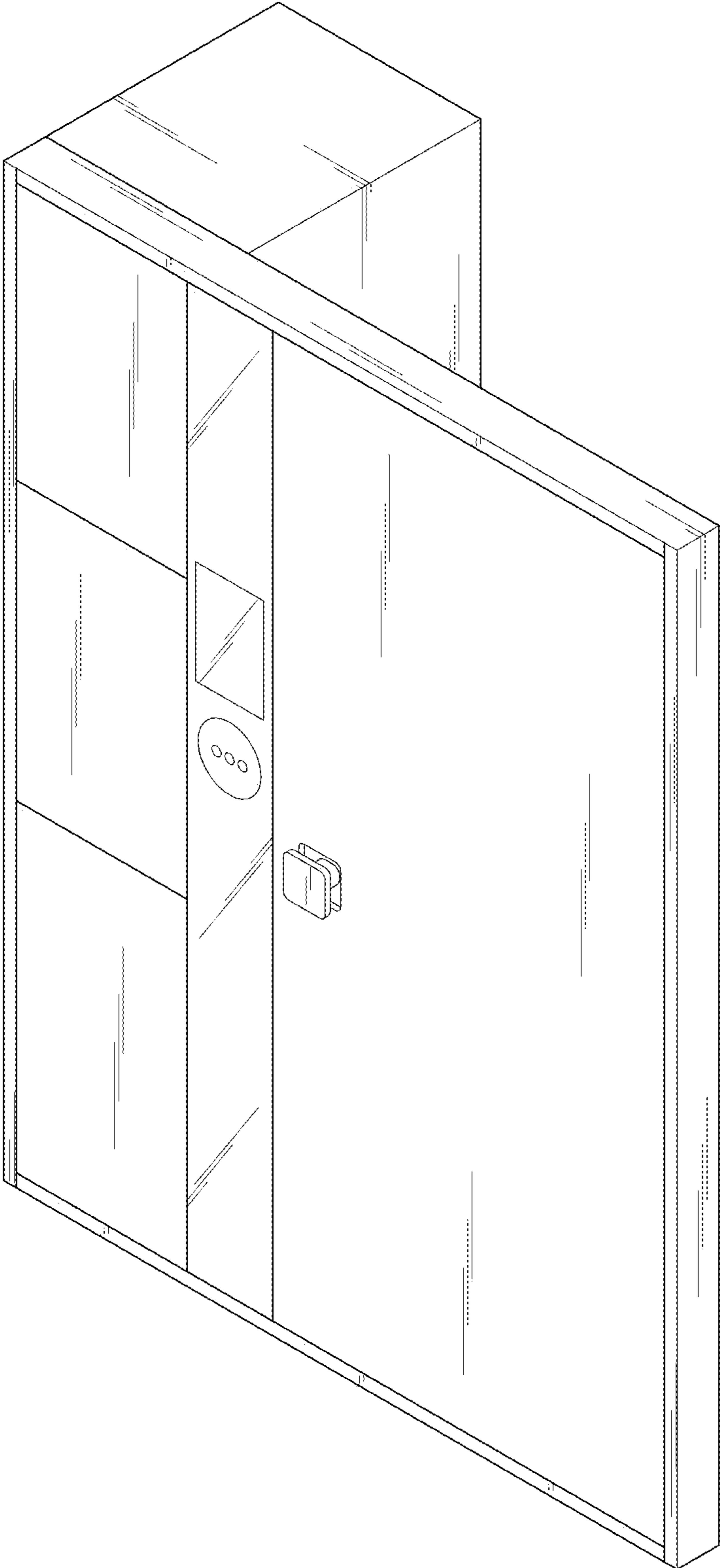

1.2

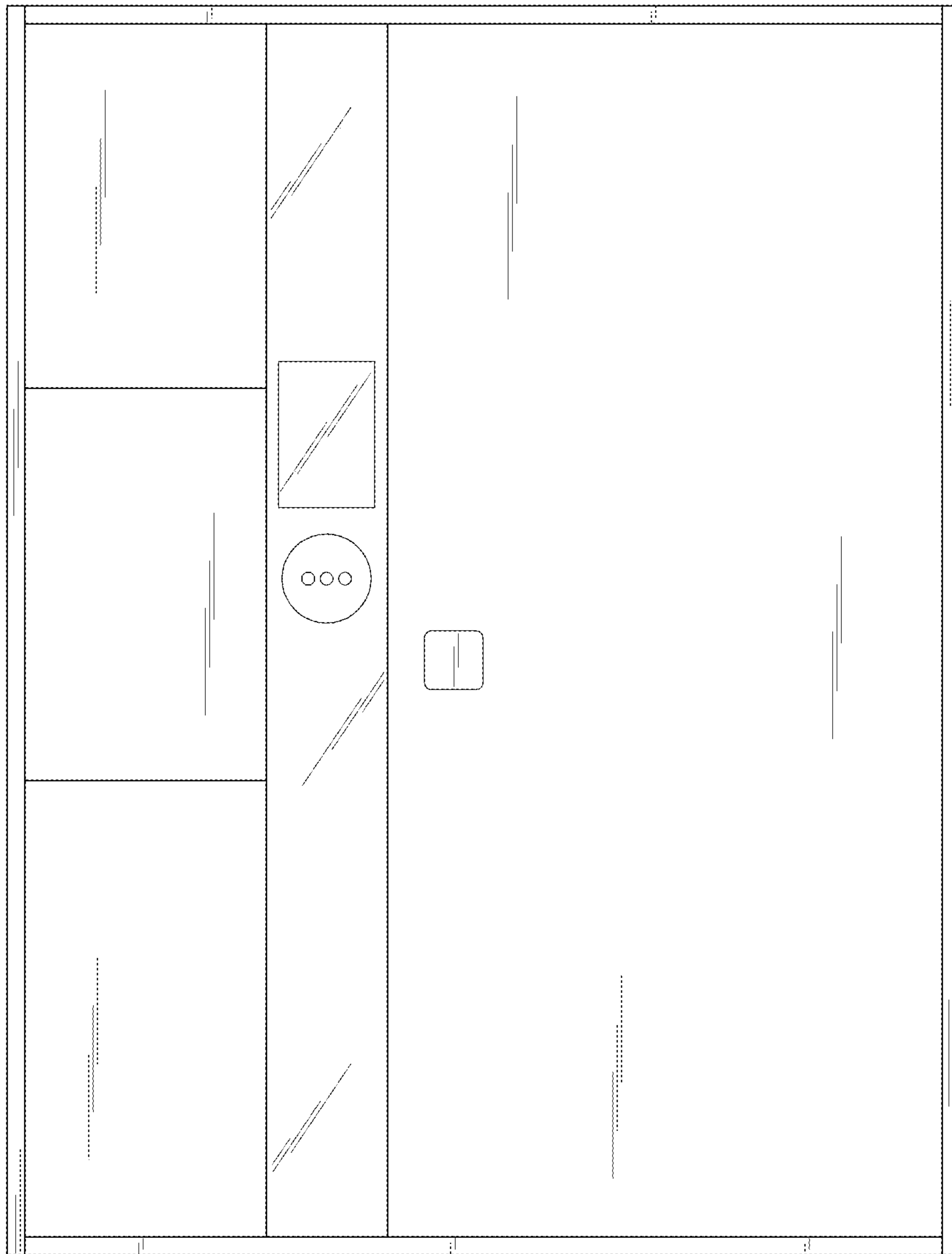

1.3

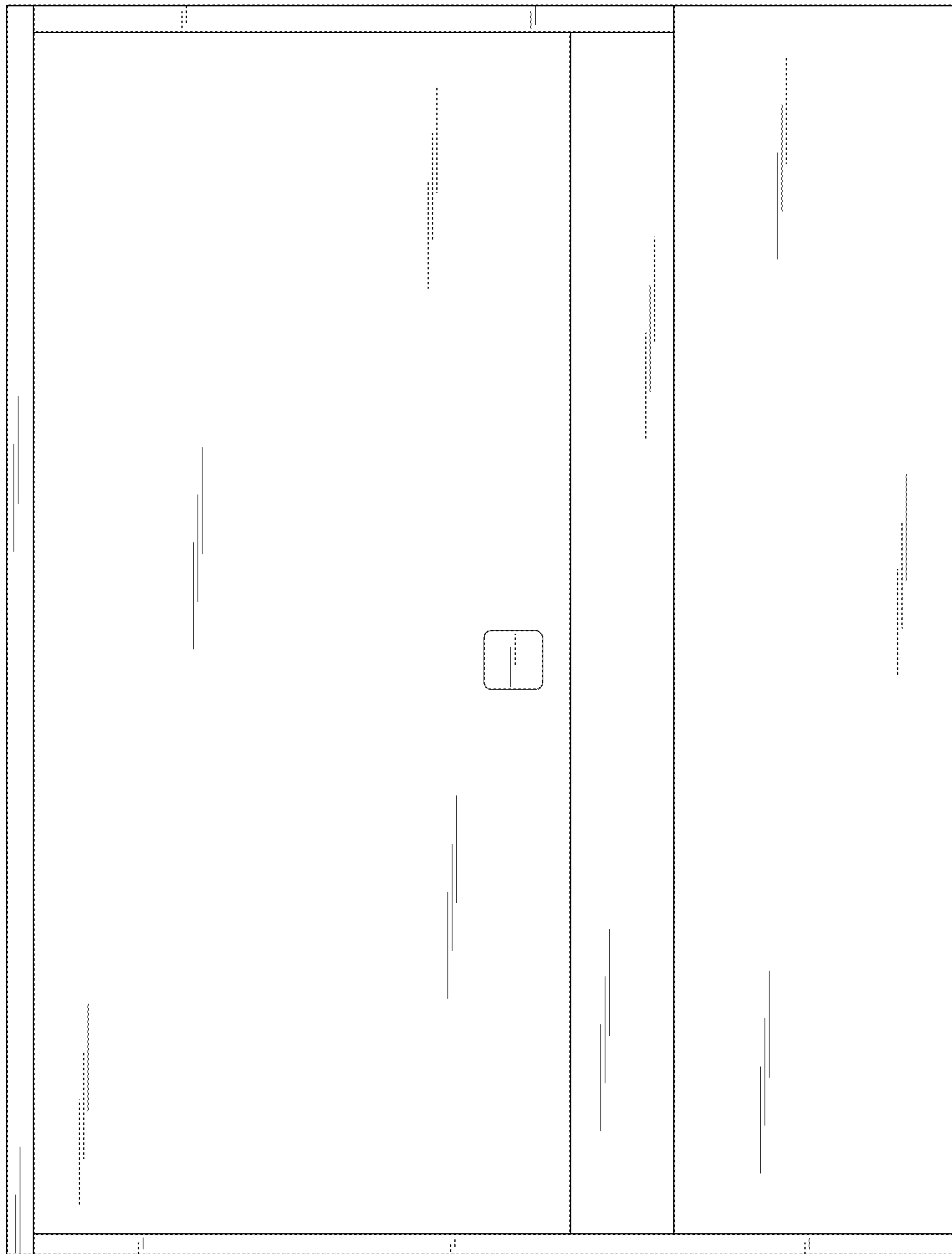

1.4

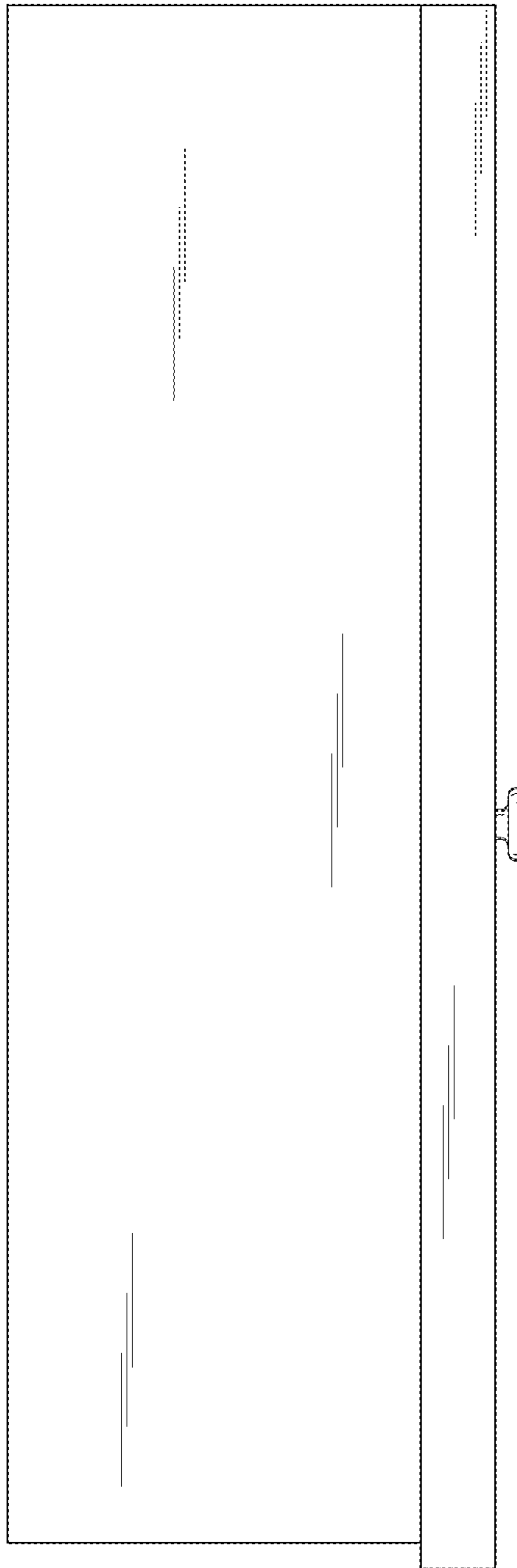

1.5

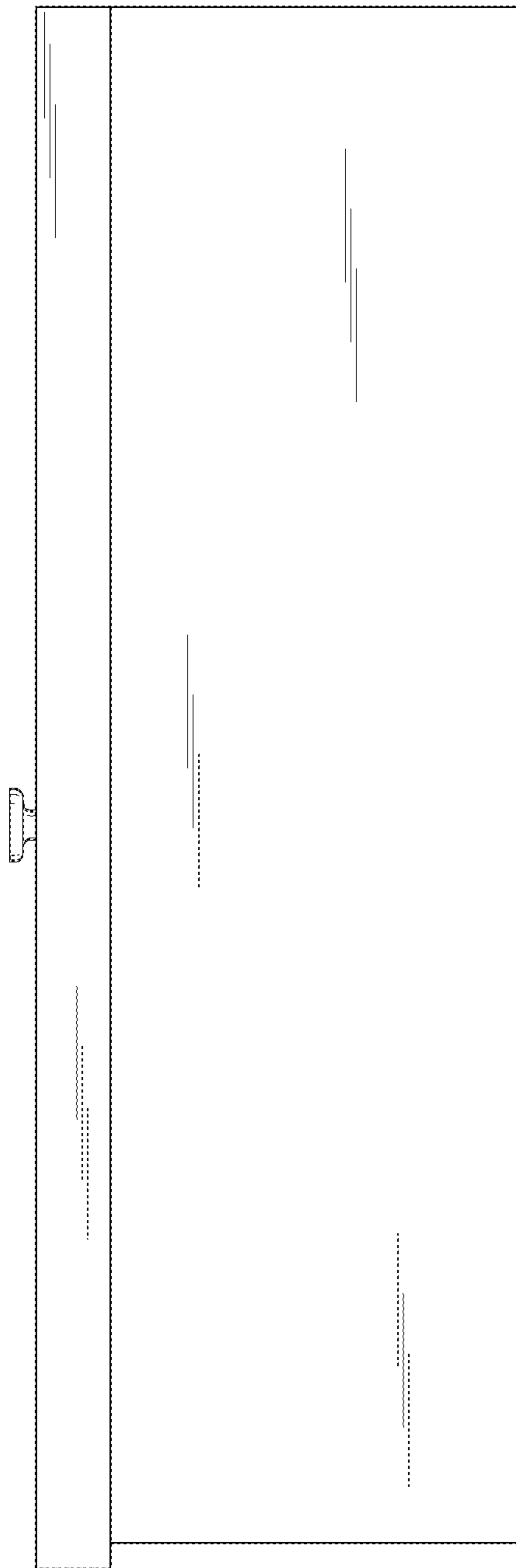

1.6

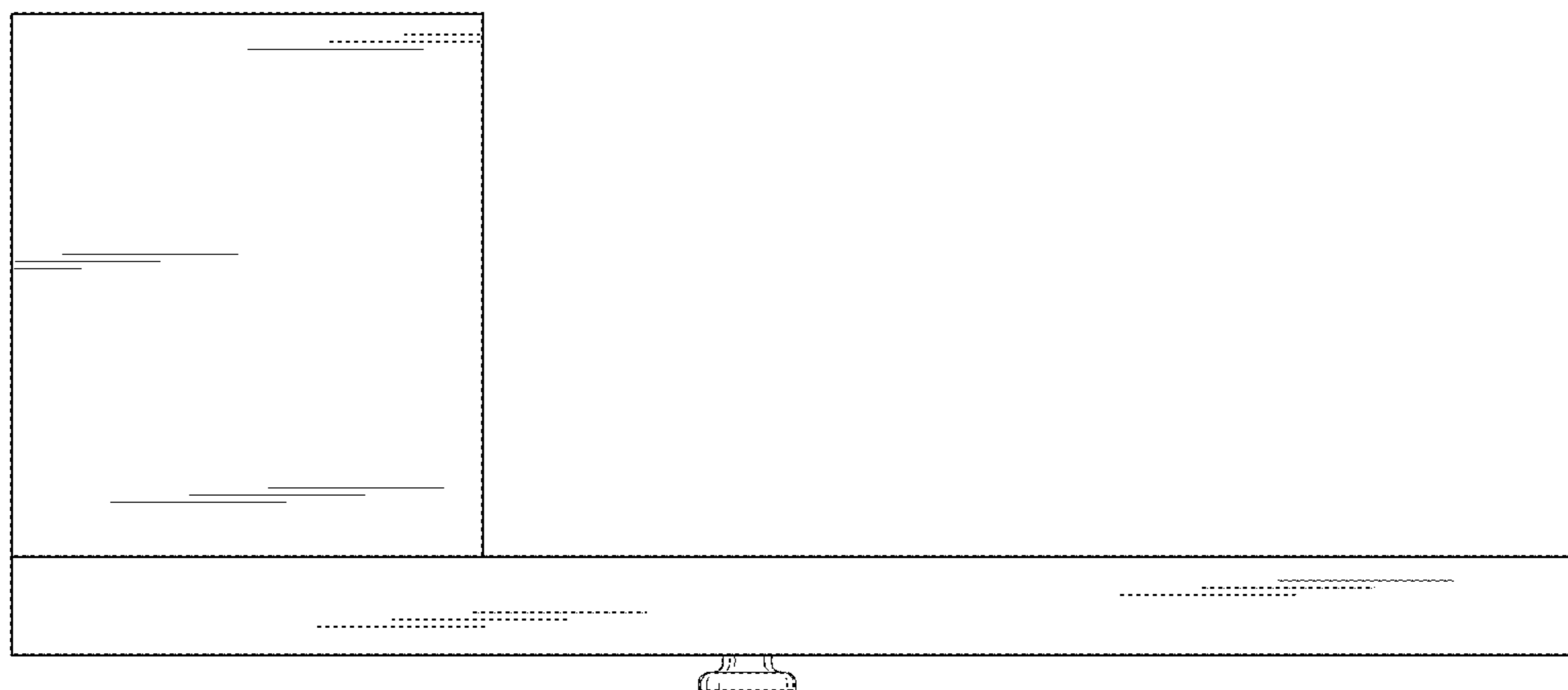

1.7

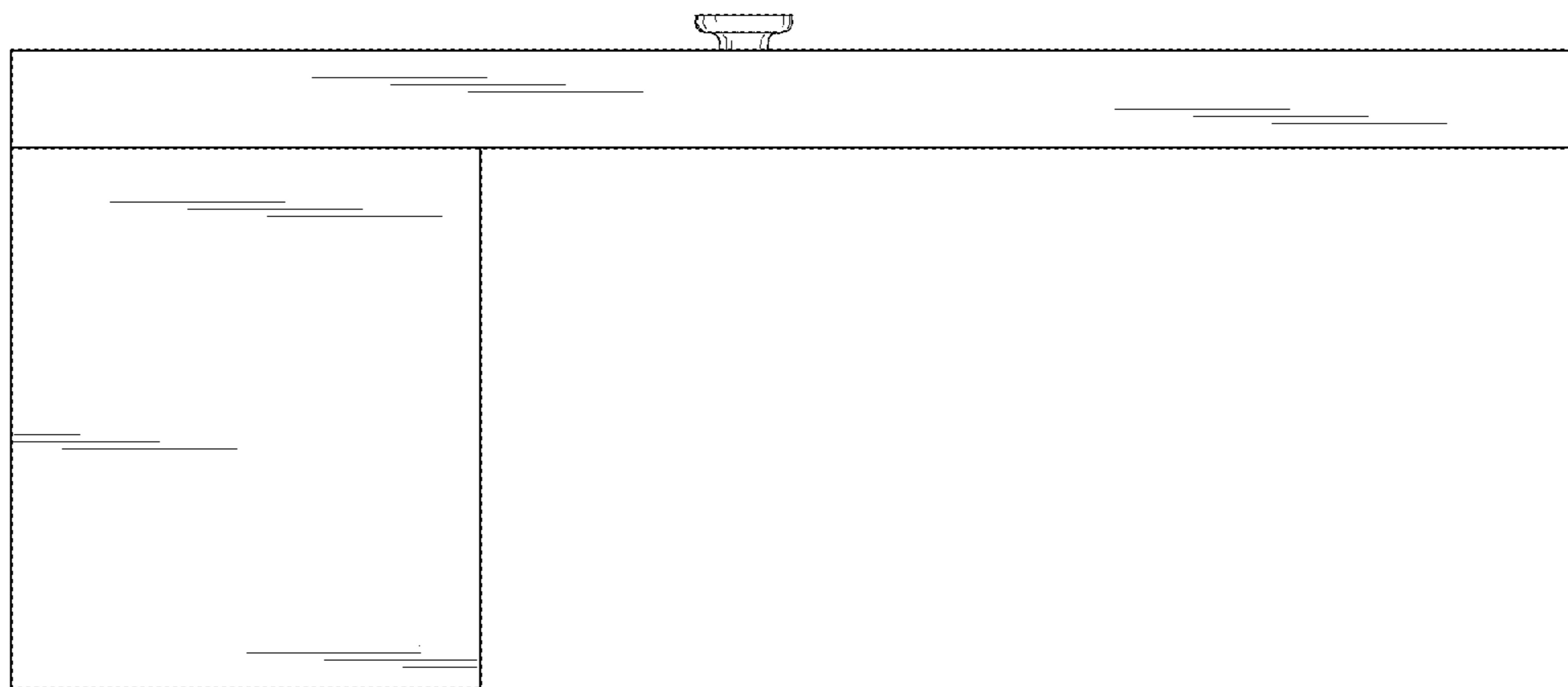

1.8

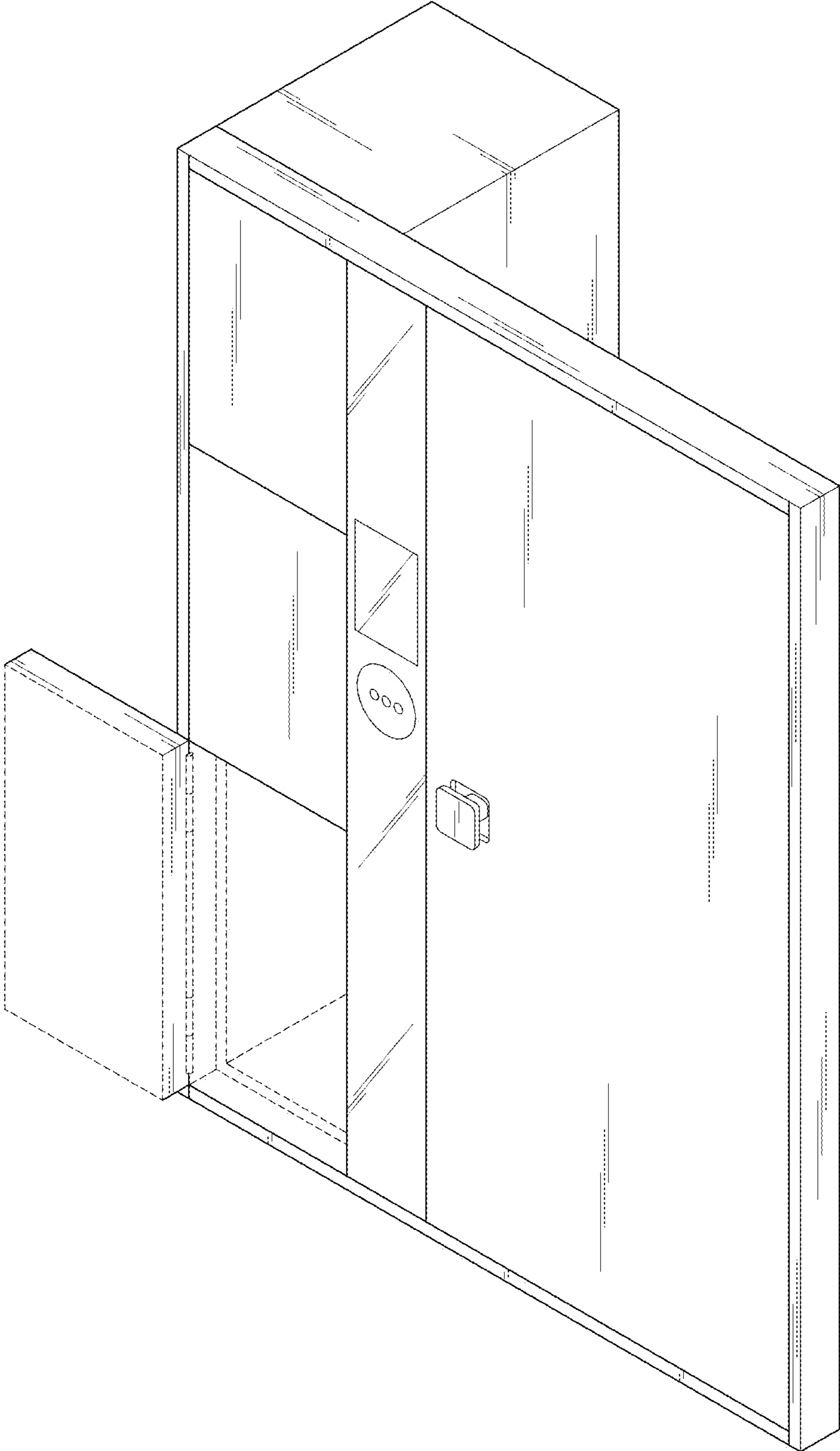

1.9

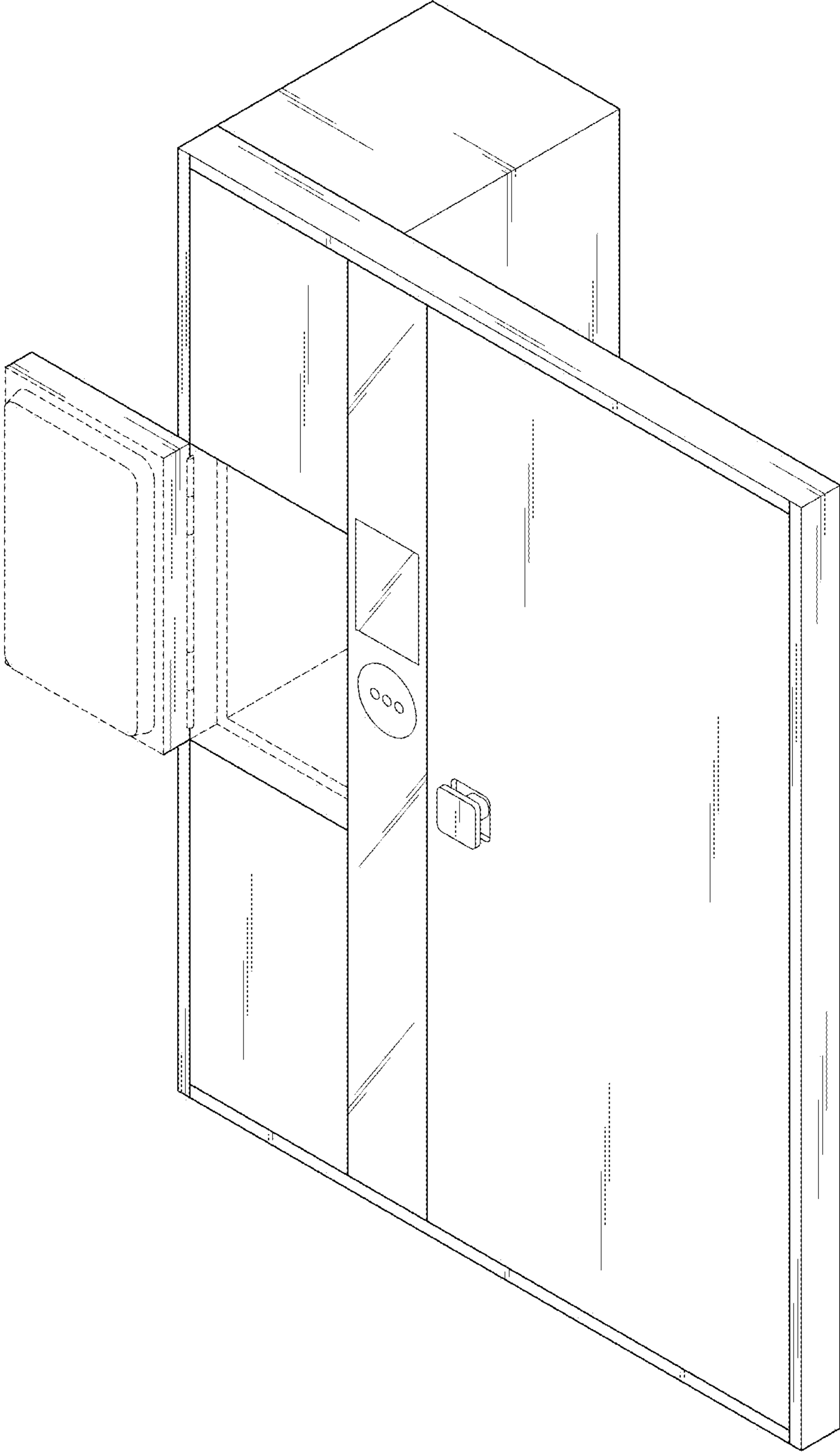

1.10

