



US00D951309S

(12) **United States Design Patent**
Lee et al.

(10) **Patent No.:** **US D951,309 S**
(45) **Date of Patent:** **** May 10, 2022**

(54) **REFRIGERATOR**

(71) Applicant: **SAMSUNG ELECTRONICS CO., LTD.**, Suwon-si (KR)

(72) Inventors: **Seonju Lee**, Suwon-si (KR);
Cheolwoong Seo, Suwon-si (KR);
Sanghyun Lee, Suwon-si (KR)

(73) Assignee: **SAMSUNG ELECTRONICS CO., LTD.**, Gyeonggi-Do (KR)

(**) Term: **15 Years**

(21) Appl. No.: **29/725,246**

(22) Filed: **Feb. 24, 2020**

(30) **Foreign Application Priority Data**

Nov. 22, 2019 (KR) 30-2019-0056049

(51) **LOC (13) Cl.** **15-07**

(52) **U.S. Cl.**
USPC **D15/91; D15/81**

(58) **Field of Classification Search**
USPC **D15/79-91**

(Continued)

(56) **References Cited**

U.S. PATENT DOCUMENTS

D720,373 S * 12/2014 Kim D15/89

D754,217 S * 4/2016 Choi D15/89

(Continued)

FOREIGN PATENT DOCUMENTS

KR 300518816 S 2/2009

KR 300676908 S 1/2013

(Continued)

OTHER PUBLICATIONS

Samsung, RB12A300641 24 Inch Bottom Freezer Refrigerator,
(Site visited Dec. 29, 2021), A.J. Madison Appliances, URL:<https://

www.ajmadison.com/cgi-bin/ajmadison/RB12A3006.html#mz-expanded-view-963375638425> (Year: 2021).*

(Continued)

Primary Examiner — Calvin E Vasant

Assistant Examiner — Mark T. Philipps

(74) *Attorney, Agent, or Firm* — Cantor Colburn LLP

(57) **CLAIM**

The ornamental design for a refrigerator, as shown and described.

DESCRIPTION

FIG. 1 is a front perspective view of a refrigerator, showing our new design;

FIG. 2 is a front view thereof;

FIG. 3 is a rear view thereof;

FIG. 4 is a left-side view thereof;

FIG. 5 is a right-side view thereof;

FIG. 6 is a top view thereof;

FIG. 7 is a bottom view thereof;

FIG. 8 is a front perspective view of a door portion thereof;

FIG. 9 is a front view of the door portion thereof;

FIG. 10 is a rear view of the door portion thereof;

FIG. 11 is a left-side view of the door portion thereof;

FIG. 12 is a right-side view of the door portion thereof;

FIG. 13 is a top view of the door portion thereof;

FIG. 14 is a bottom view of the door portion thereof;

FIG. 15 is an enlarged view of the portion 15 in FIG. 8;

FIG. 16 is a partially enlarged cross-sectional view of the door portion thereof, taken along line 16-16 in FIG. 9; and,

FIG. 17 is a partially enlarged cross-sectional view of the door portion thereof, taken along line 17-17 in FIG. 9.

The even-dash broken lines illustrating portions of the refrigerator form no part of the claimed design. The dot-dot-dash broken lines encircling enlargement portions of the refrigerator form no part of the claimed design.

1 Claim, 17 Drawing Sheets

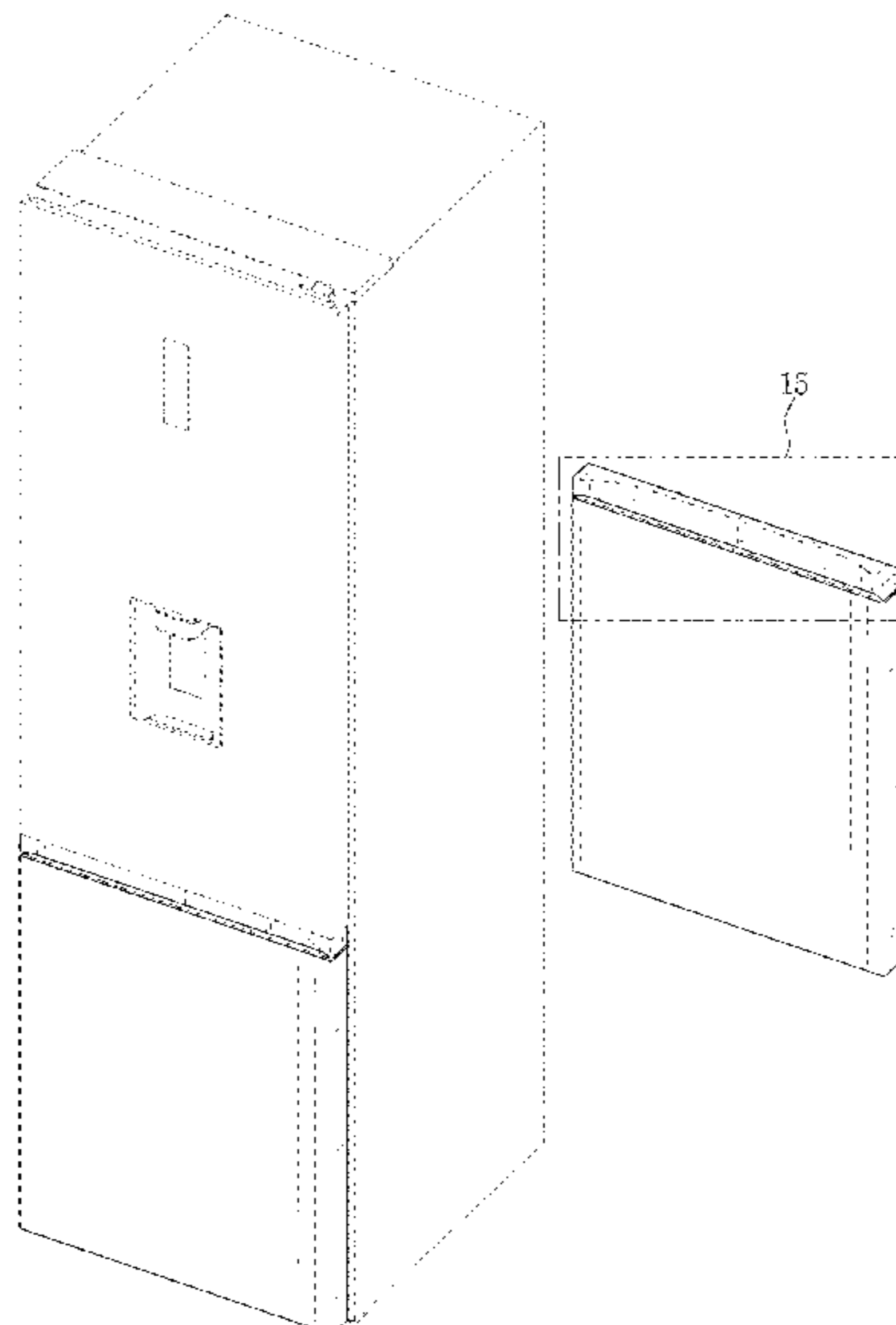

(58) **Field of Classification Search**

CPC F25D 2323/021; F25D 2323/024; F25D 29/00; F25D 27/005; F25D 29/005; F25D 17/042; F25D 2325/021; F25D 11/00; F25D 11/02; F25D 11/025; F25D 23/00; F25D 23/02; F25D 23/04; F25D 23/12; F25D 23/028; F25D 25/02; F25D 25/021; F25D 25/022; F25D 25/024; F25D 25/025; A47F 3/04; A47F 3/0404

See application file for complete search history.

2018/0038626 A1* 2/2018 Kim E05F 15/73
2018/0156520 A1* 6/2018 Lindel F25D 11/00
2018/0164033 A1* 6/2018 Lee F25D 29/005
2020/0263479 A1* 8/2020 Lee F25D 29/005
2020/0326119 A1* 10/2020 Lee F25D 23/02
2021/0372688 A1* 12/2021 Kang F25D 23/02

FOREIGN PATENT DOCUMENTS

KR 300676909 S 1/2013
KR 300890395 S 1/2017
KR 300897440 S 3/2017

(56) **References Cited**

U.S. PATENT DOCUMENTS

D755,261 S * 5/2016 Choi D15/89
D758,461 S * 6/2016 Lee D15/91
D771,161 S * 11/2016 Park D15/91
D841,060 S * 2/2019 Jeon D15/91
D847,214 S * 4/2019 Guo D15/81
D905,767 S * 12/2020 Lee D15/89
D908,748 S * 1/2021 Lee D15/91
D921,064 S * 6/2021 Lee D15/89
D921,065 S * 6/2021 Lee D15/89
D921,711 S * 6/2021 Lee D15/85
D921,714 S * 6/2021 Yoon D15/86
2013/0026900 A1* 1/2013 Oh E05D 11/06
312/401

OTHER PUBLICATIONS

Samsung, "Bring professional quality home. Discover how Samsung Home Appliances can deliver you the perfect kitchen.", (posted Jul. 31, 2017), Instagram.com, URL:<<https://www.instagram.com/p/BXNJxm4ltMa/>> (Year: 2017).*
LG Electronics, Signature Q23FGNGR Refrigerator, (site visited Dec. 9, 2021), LG.com, URL:<<https://www.lg.com/jp/refrigerators/lg-gr-q23fgngr#>> (Year: 2021).*
LG Electronics, LRSOS2706S 36 Inch Print proof Stainless Steel Side by Side Refrigerator, (site visited Dec. 10, 2021), LG.com, URL: <<https://www.appliancesconnection.com/lg-lrsos2706s.html>> (Year: 2021).*

* cited by examiner

FIG. 1

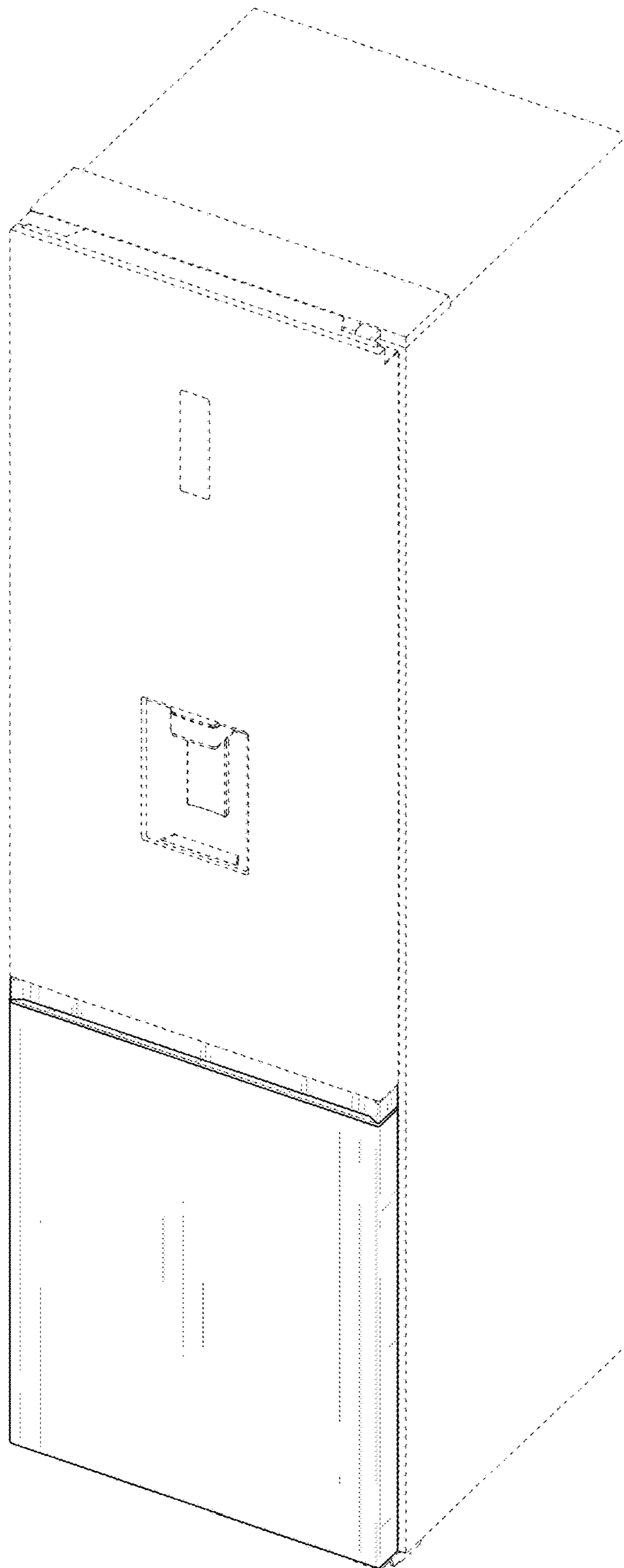

FIG. 2

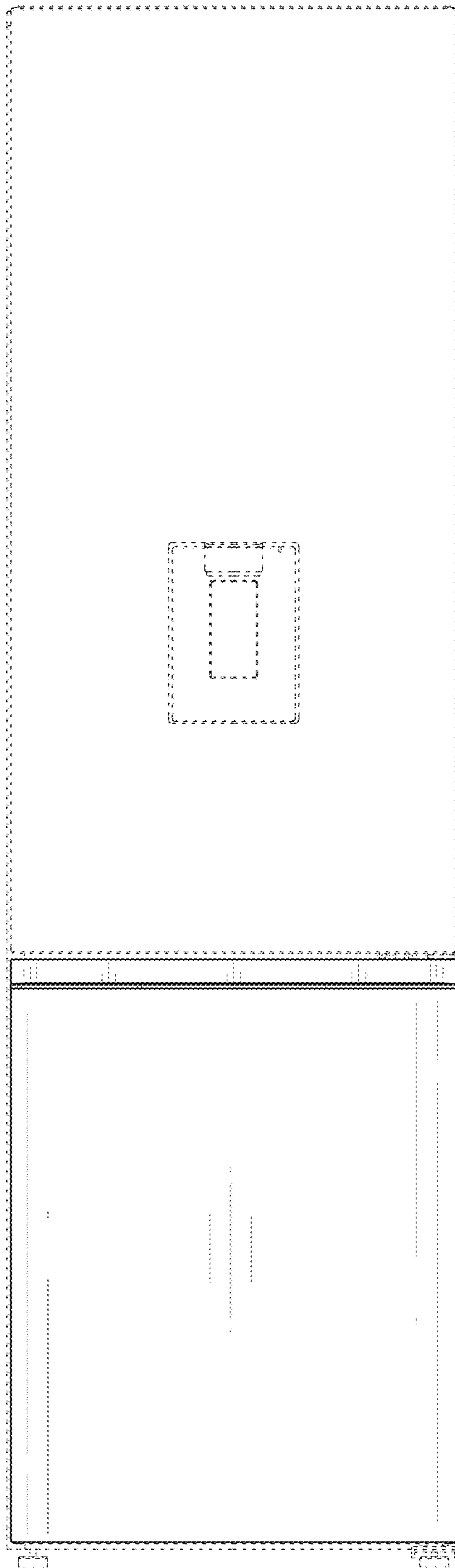

FIG. 3



FIG. 4

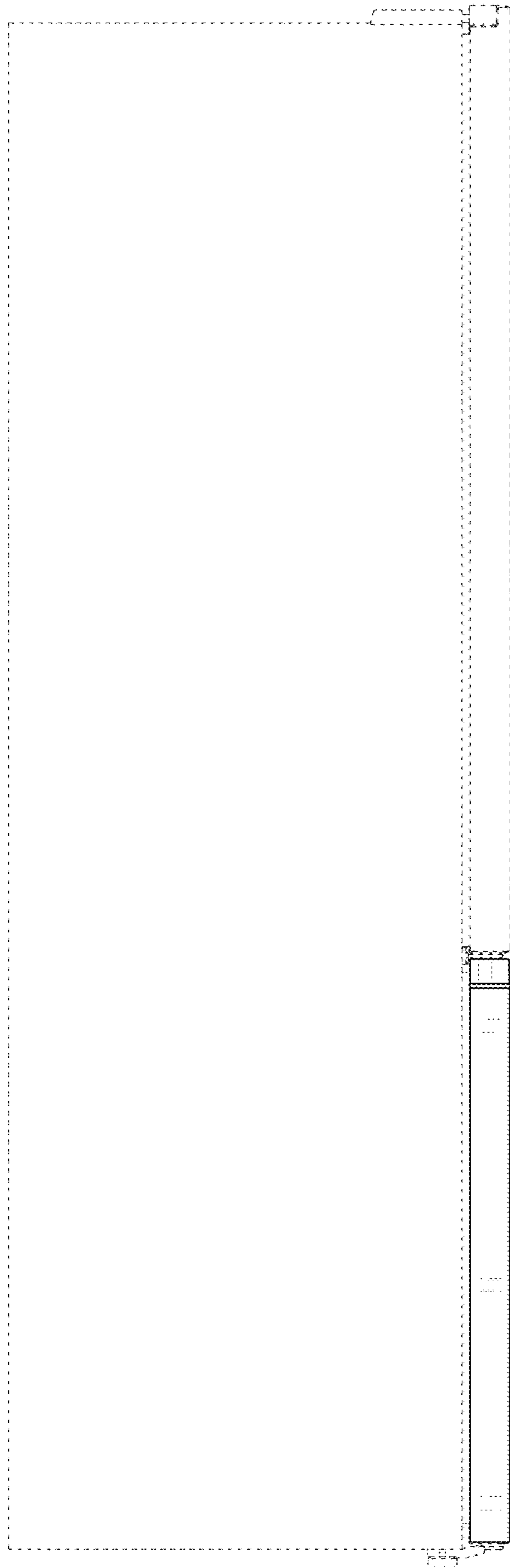

FIG. 5

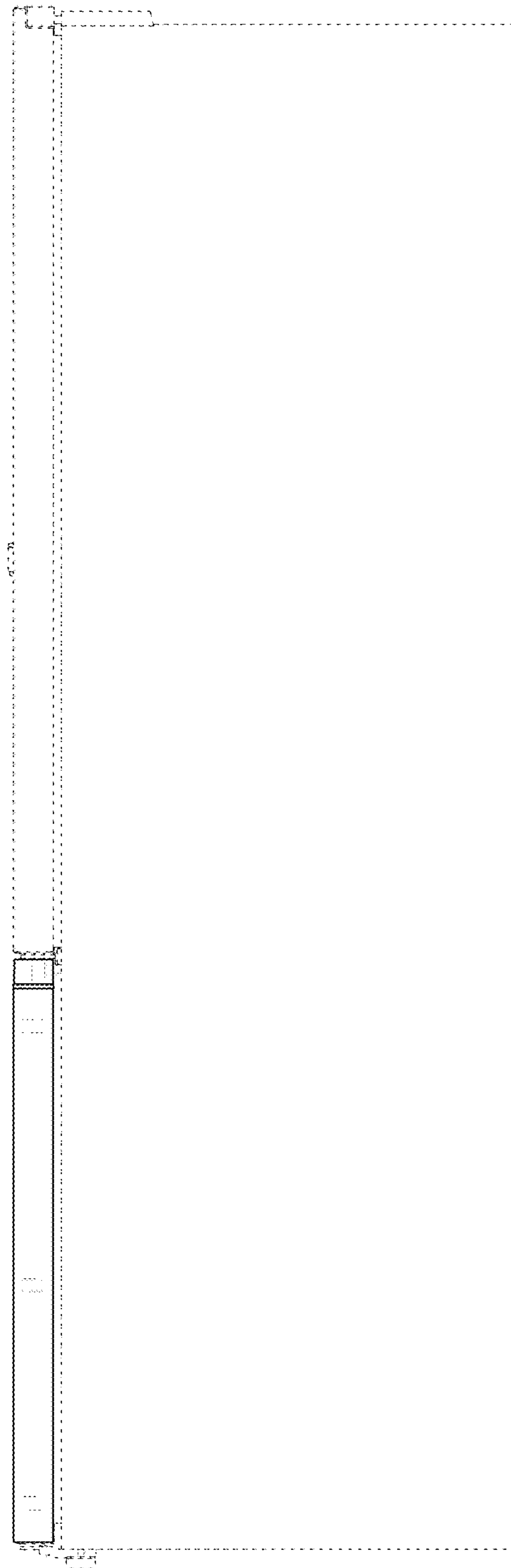

FIG. 6

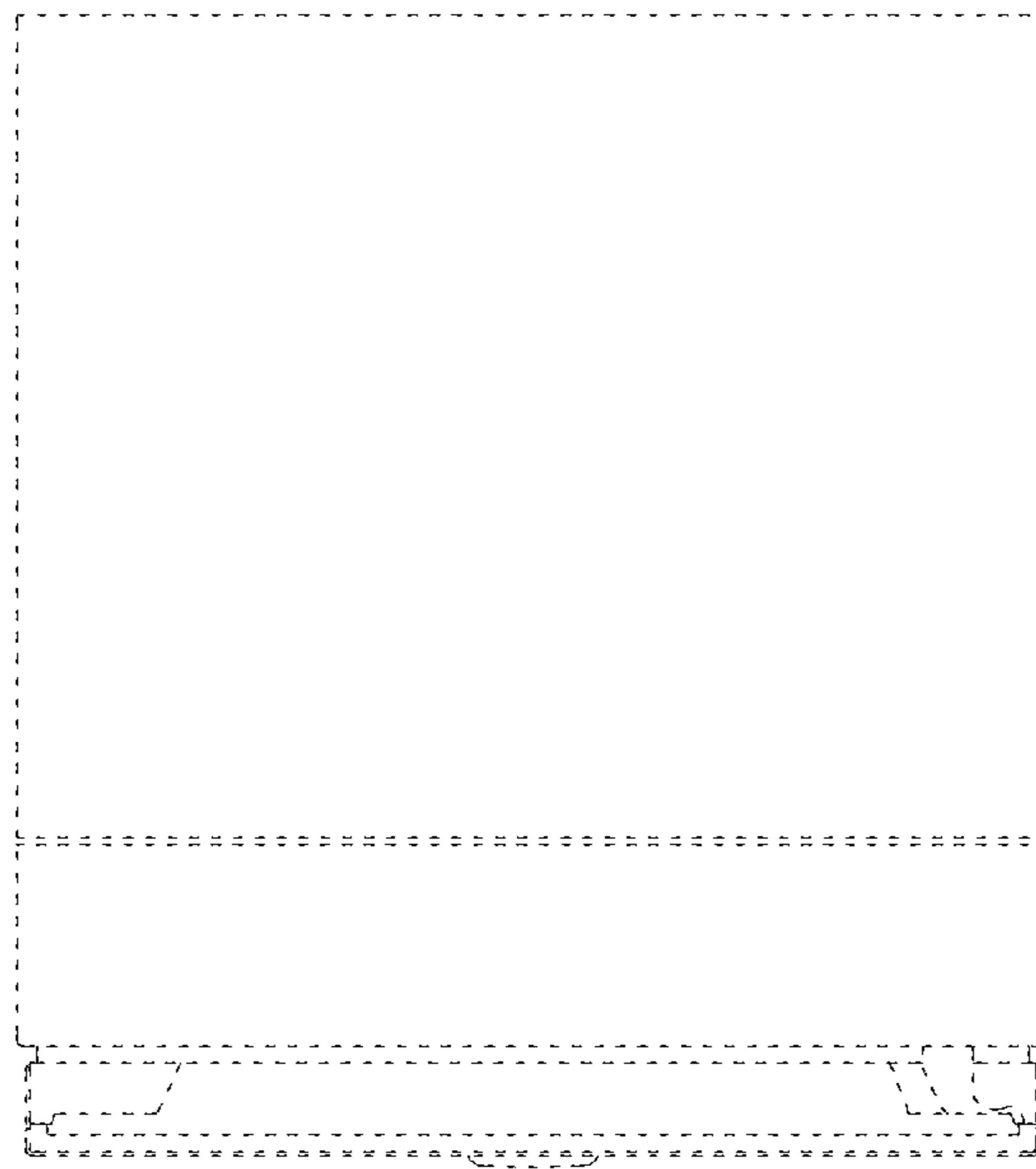

FIG. 7

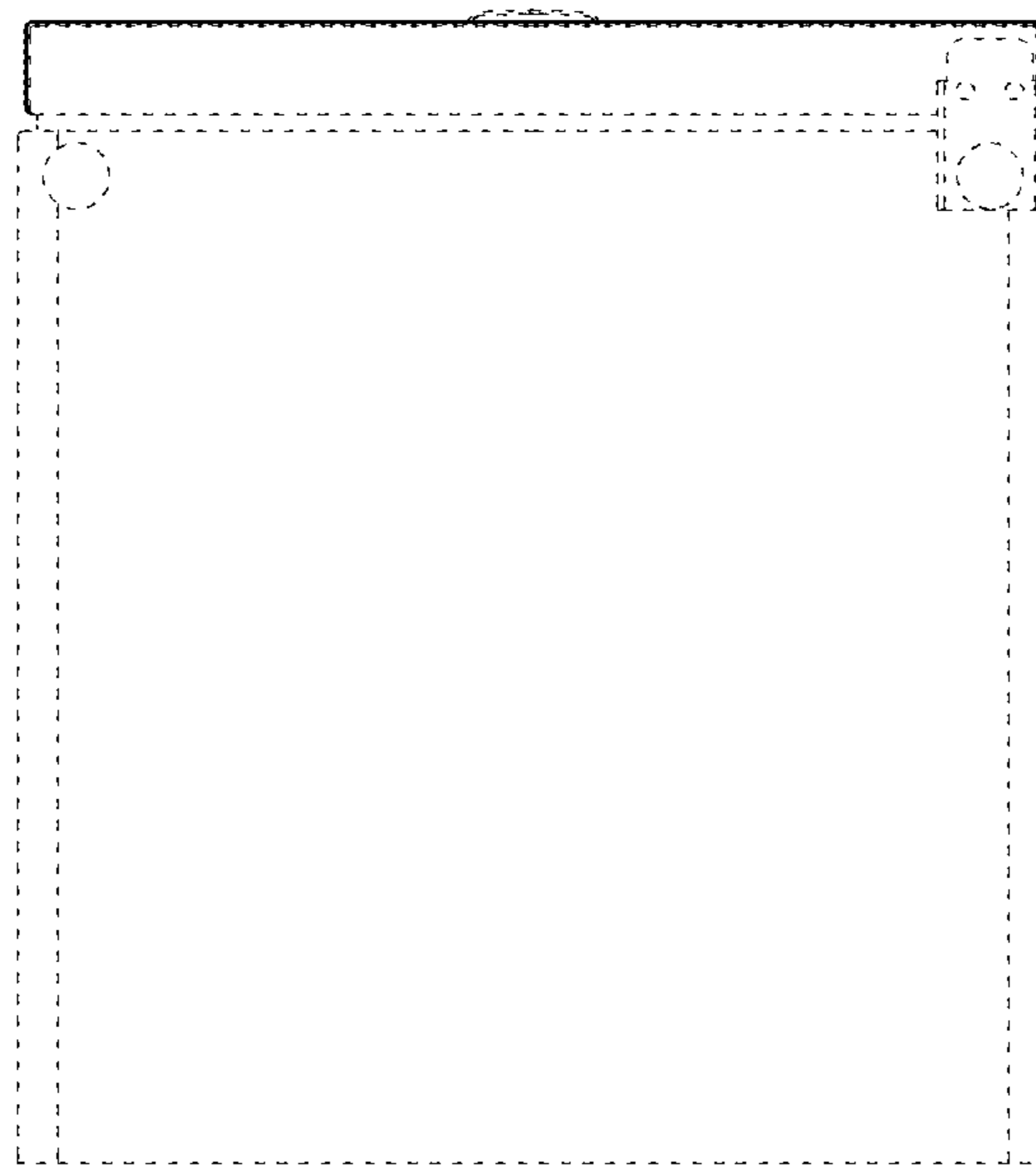

FIG. 8

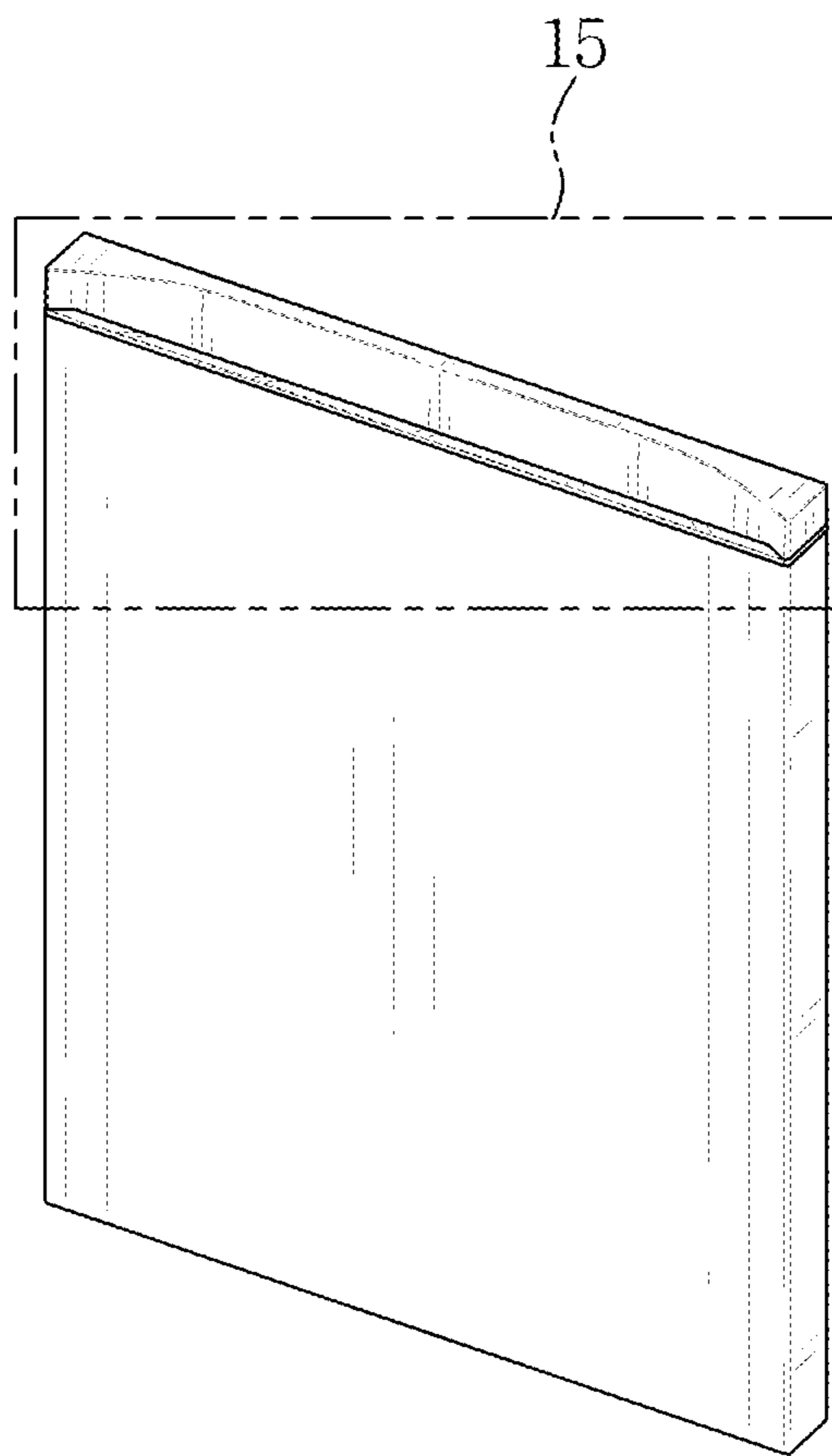

FIG. 9

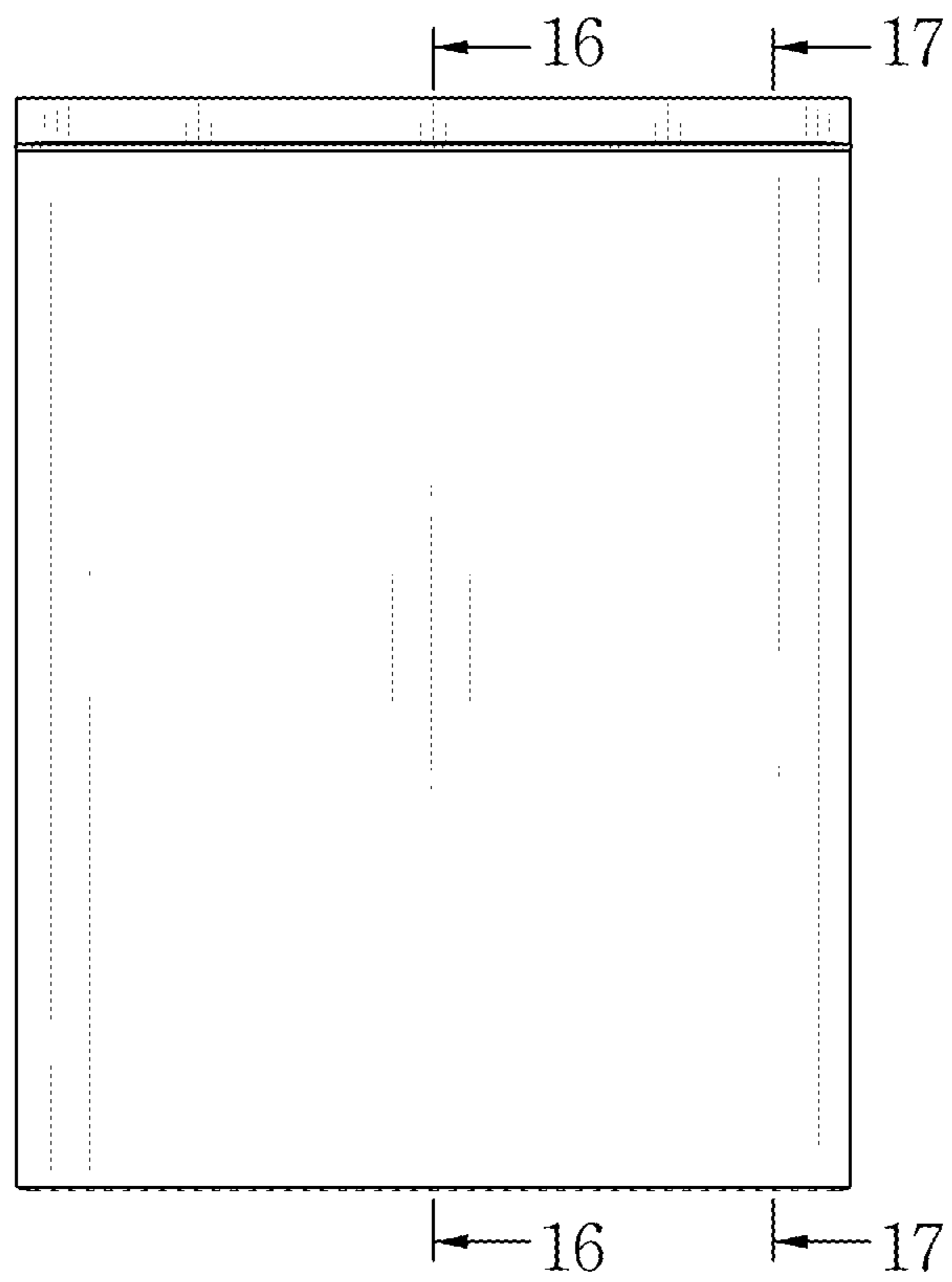

FIG. 10

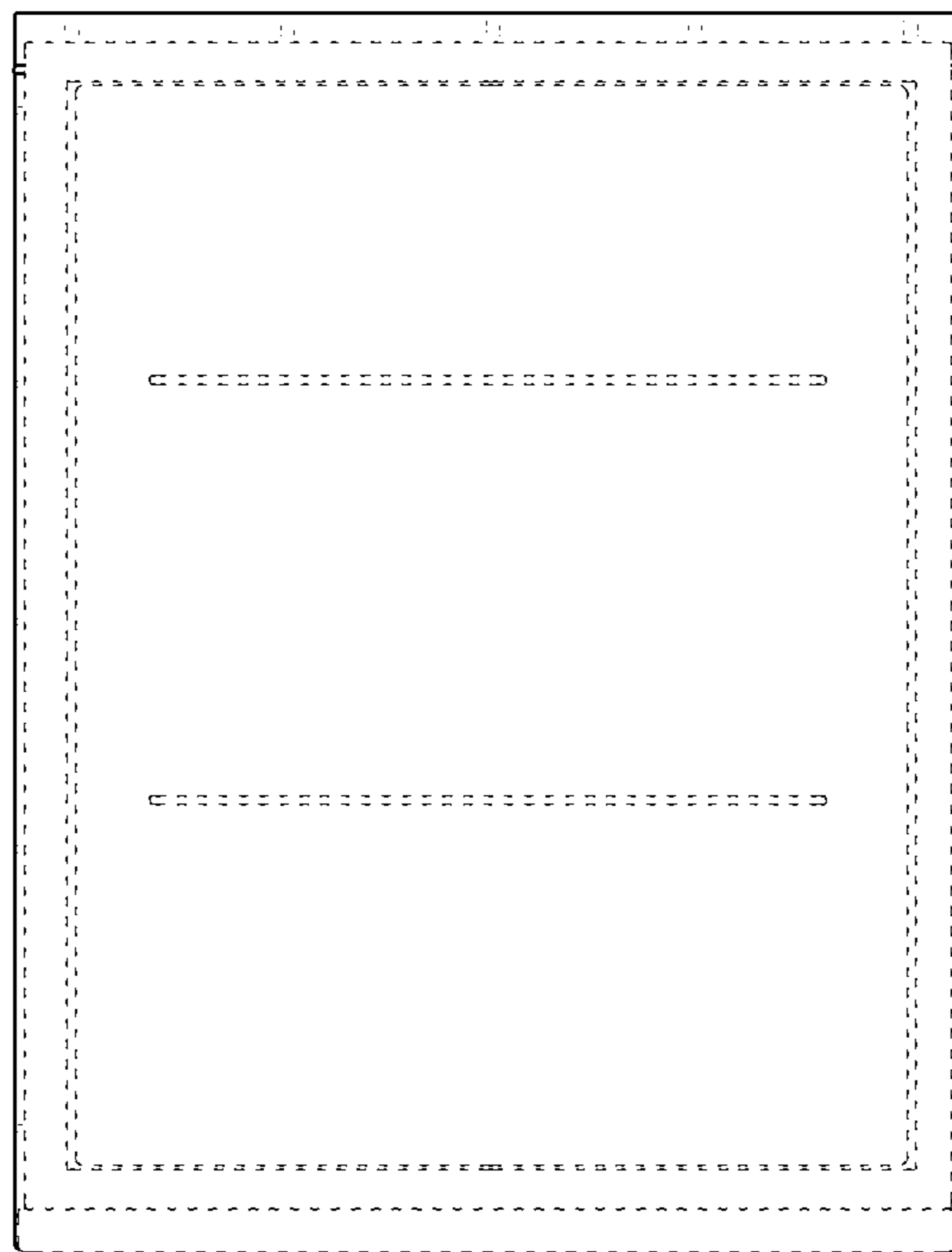

FIG. 11

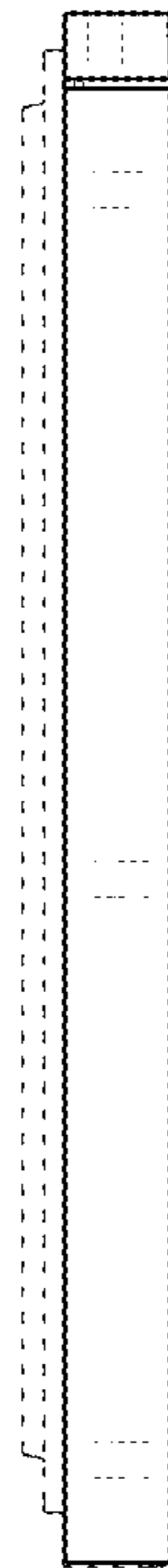

FIG. 12

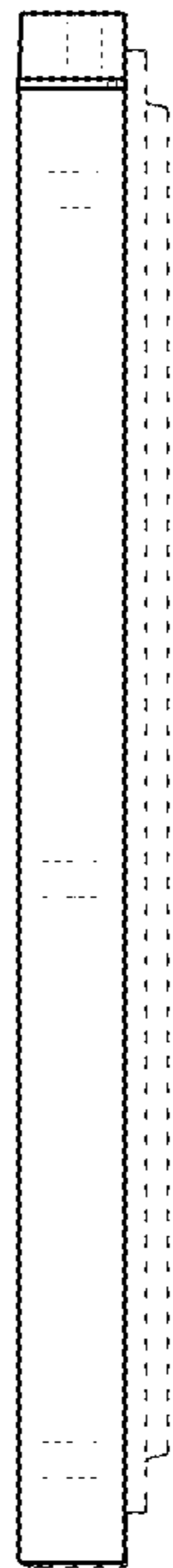

FIG. 13

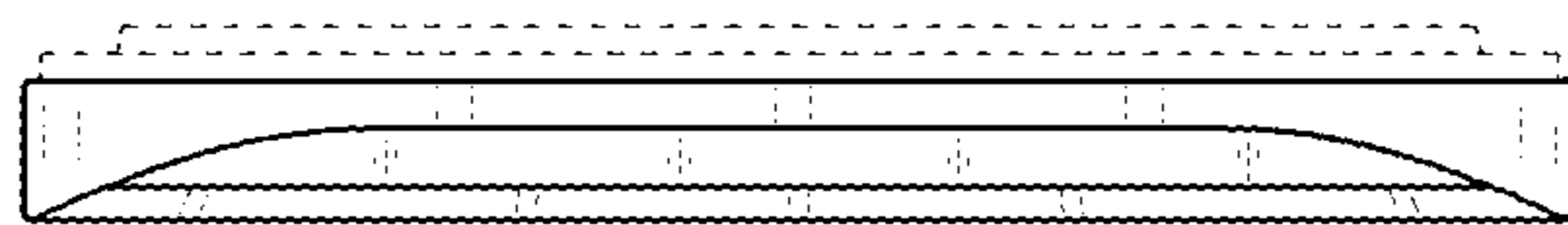

FIG. 14



FIG. 15

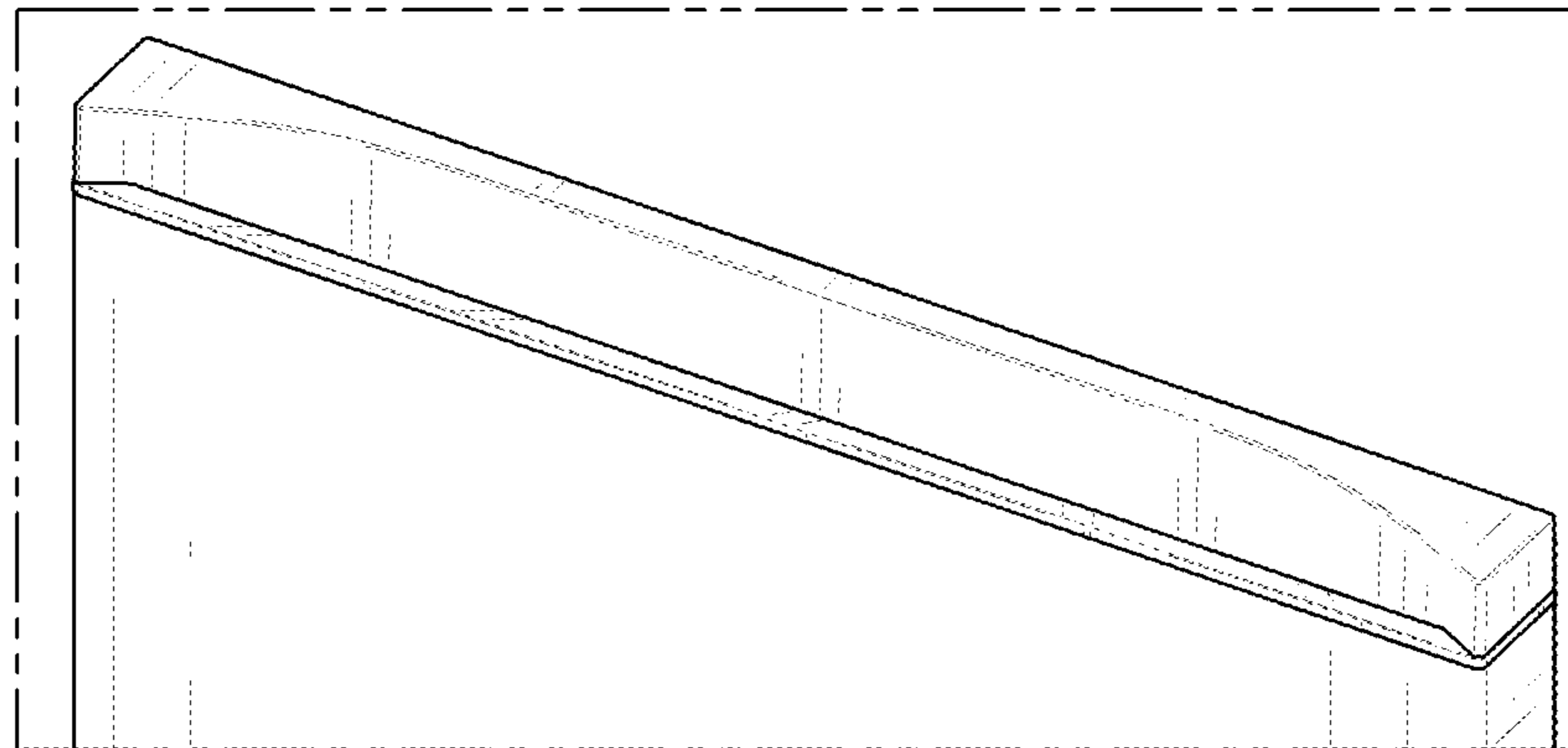

FIG. 16

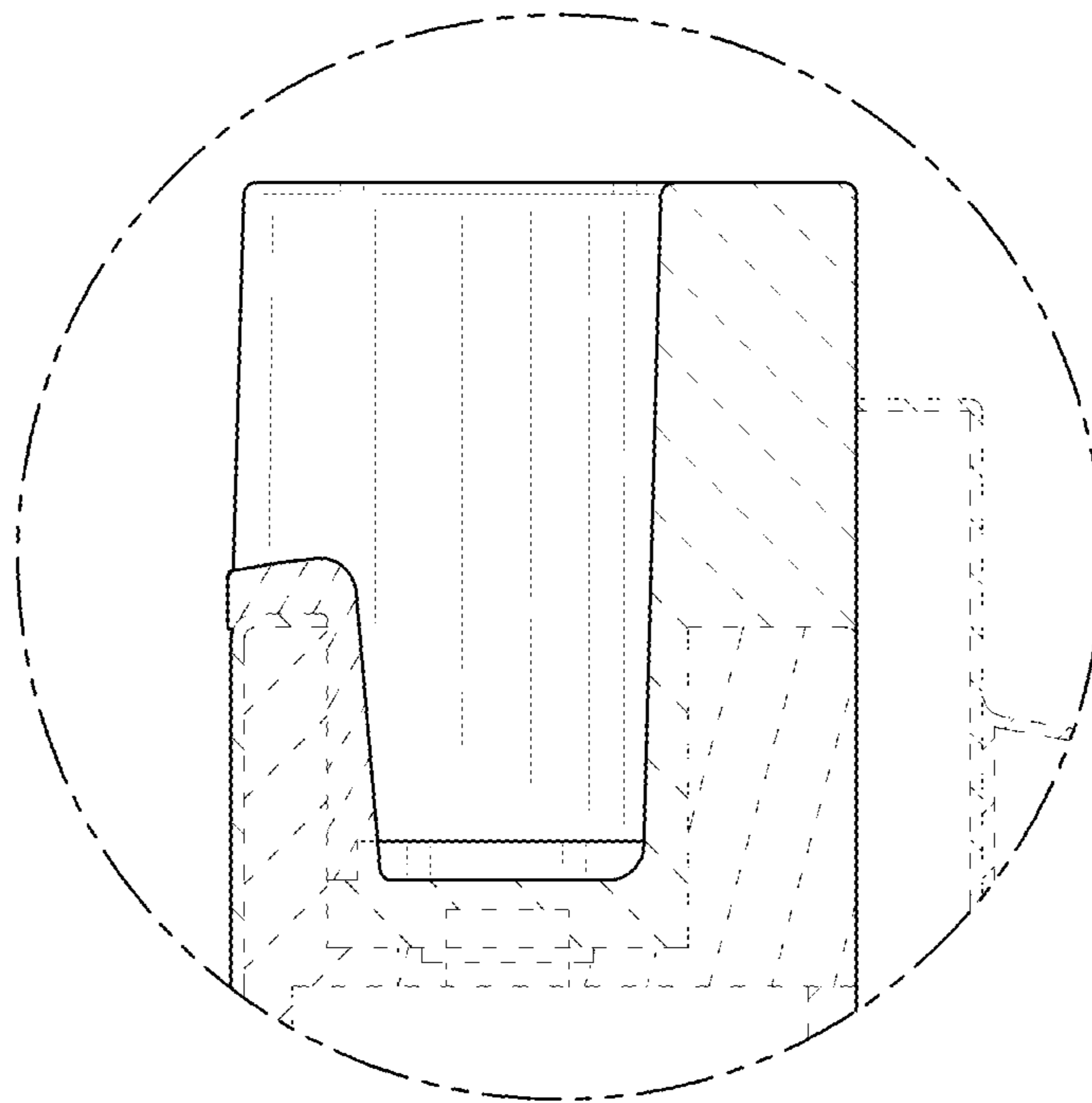

FIG. 17

