



US00D951250S

(12) **United States Design Patent**
Wei et al.

(10) **Patent No.:** **US D951,250 S**
(45) **Date of Patent:** **** May 10, 2022**

- (54) **DISPLAY DEVICE**
- (71) Applicant: **HTC Corporation**, Taoyuan (TW)
- (72) Inventors: **Chang-Hua Wei**, Taoyuan (TW);
Pei-Pin Huang, Taoyuan (TW)
- (73) Assignee: **HTC CORPORATION**, Taoyuan (TW)
- (**) Term: **15 Years**
- (21) Appl. No.: **29/757,230**
- (22) Filed: **Nov. 4, 2020**
- (51) **LOC (13) Cl.** **14-02**
- (52) **U.S. Cl.**
USPC **D14/372**
- (58) **Field of Classification Search**
USPC D14/372, 496, 432, 371, 125, 126, 129,
D14/299; D16/300–342; 351/158, 153,
351/144; 345/7–9, 905; 455/344;
348/115, 53, 121, 739
CPC G02B 27/017; G02B 27/0158; G02B
27/0161; G02B 27/0181; G02B 27/0185;
G02B 27/0189
See application file for complete search history.

D910,018 S *	2/2021	Amijo	D14/372
D914,020 S *	3/2021	Wei	D14/372
D925,528 S *	7/2021	Bristol	D14/372
D929,401 S *	8/2021	Chiang	D14/372
D938,421 S *	12/2021	Bhat	D14/372

FOREIGN PATENT DOCUMENTS

CN	305337097 S	9/2019
TW	D188026 S	1/2018
TW	D201359 S	12/2019
TW	D205548 S	7/2020

* cited by examiner

Primary Examiner — Austin Murphy

(74) *Attorney, Agent, or Firm* — Birch, Stewart, Kolasch & Birch, LLP

(57) **CLAIM**

The ornamental design for a display device, as shown and described.

DESCRIPTION

FIG. 1 is a perspective view of a display device in accordance with our new design;
 FIG. 2 is a front view thereof;
 FIG. 3 is a rear view thereof;
 FIG. 4 is a left view thereof;
 FIG. 5 is a right view thereof;
 FIG. 6 is a top plan view thereof; and,
 FIG. 7 is a bottom plan view thereof.
 The broken lines immediately adjacent the claimed areas represent the bounds of the claimed design while all other broken lines are directed to environment and are for illustrative purposes only. The broken lines form no part of the claimed design.

1 Claim, 7 Drawing Sheets

(56) **References Cited**

U.S. PATENT DOCUMENTS

D875,094 S *	2/2020	Miller	D14/372
10,663,737 B1 *	5/2020	Magrath	H01R 13/6205
D890,171 S *	7/2020	Wei	D14/372
D890,173 S *	7/2020	Wei	D14/372
D892,792 S *	8/2020	Miller	D14/372
D893,478 S *	8/2020	Watanabe	D14/372
D894,897 S *	9/2020	Wei	D14/372
D896,223 S *	9/2020	Amijo	D14/372
D900,095 S *	10/2020	Wang	D14/372
D900,099 S *	10/2020	Park	D14/372
D910,014 S *	2/2021	Amijo	D14/372
D910,015 S *	2/2021	Amijo	D14/372

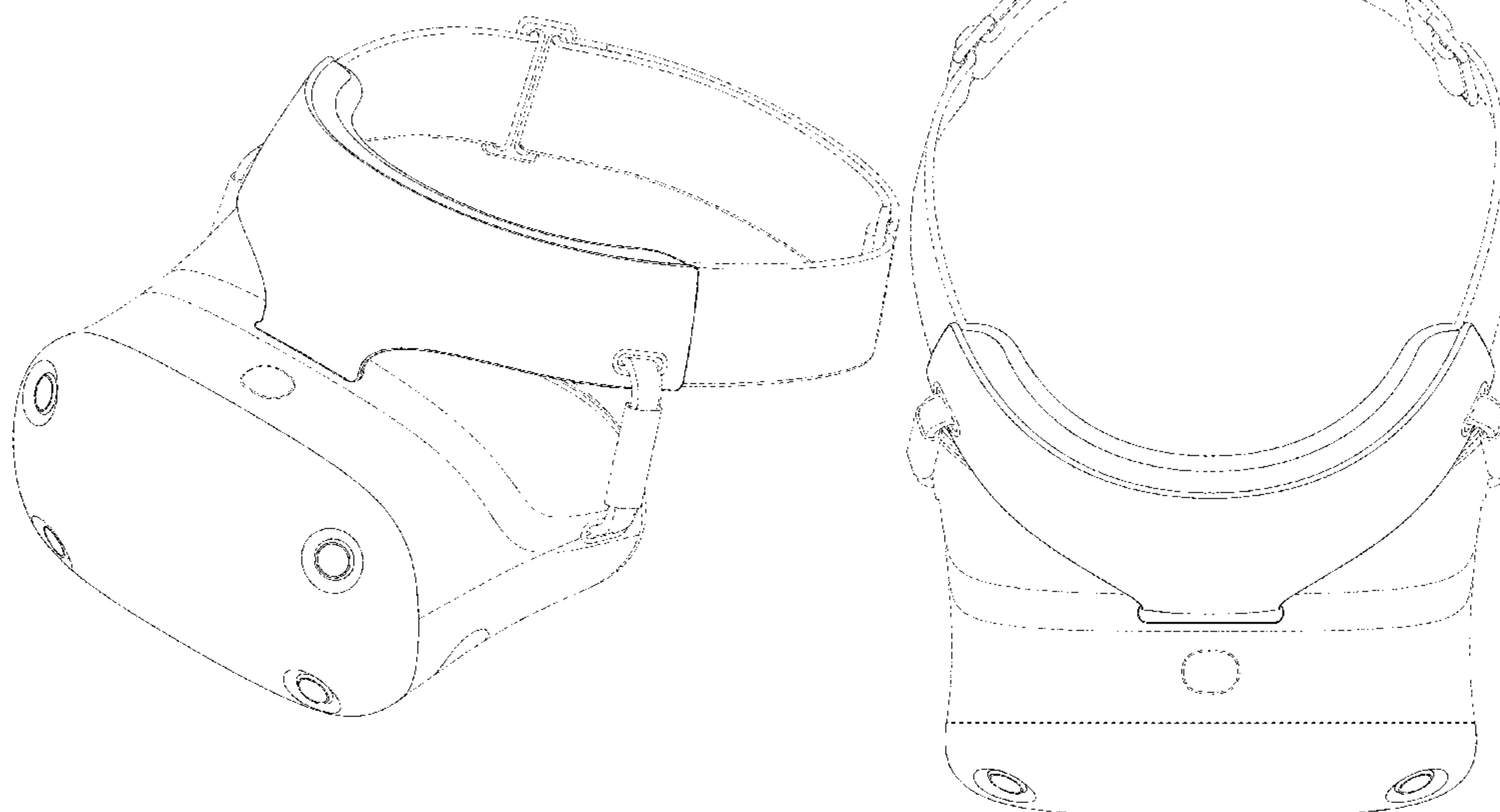

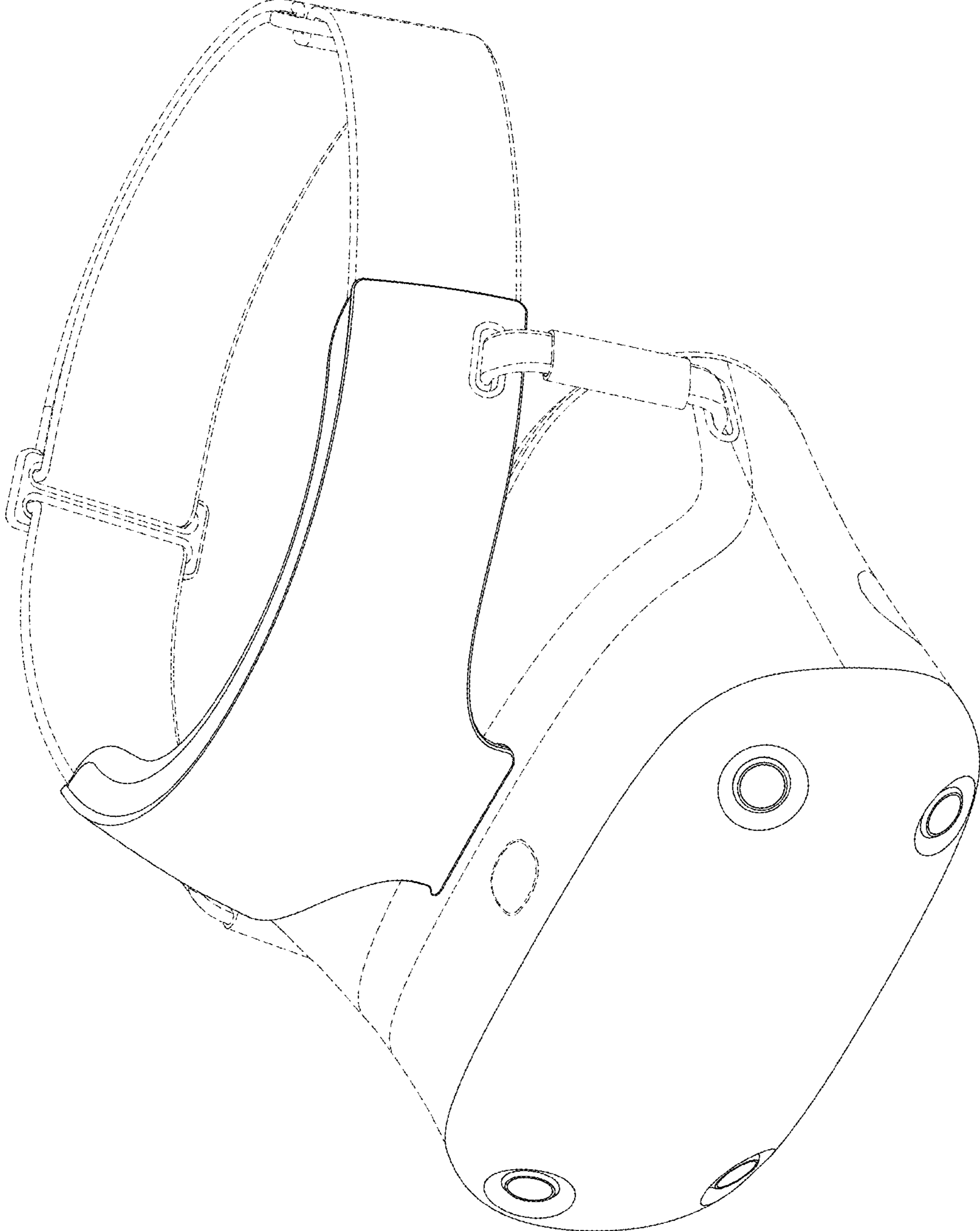

FIG. 1

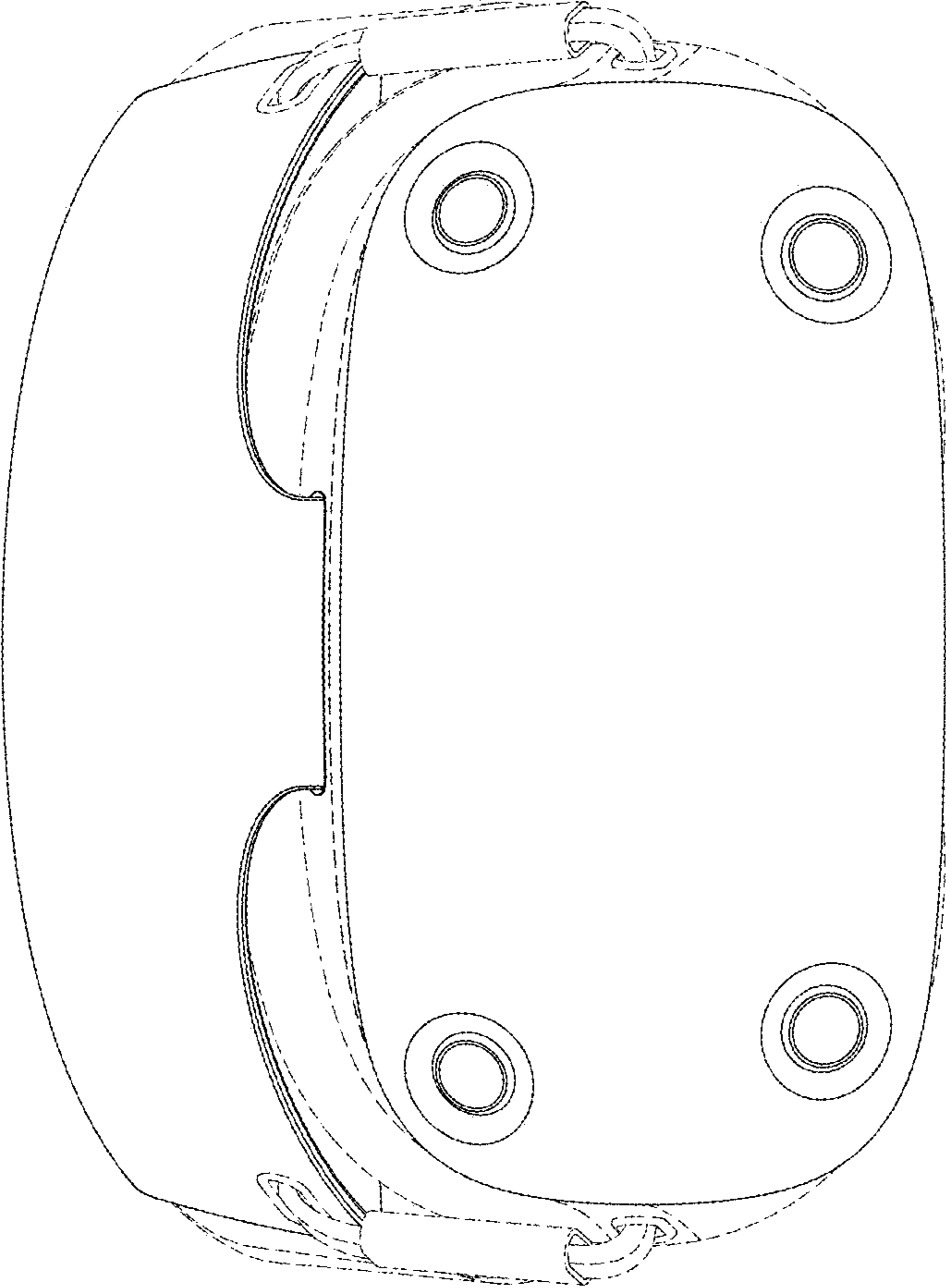

FIG. 2

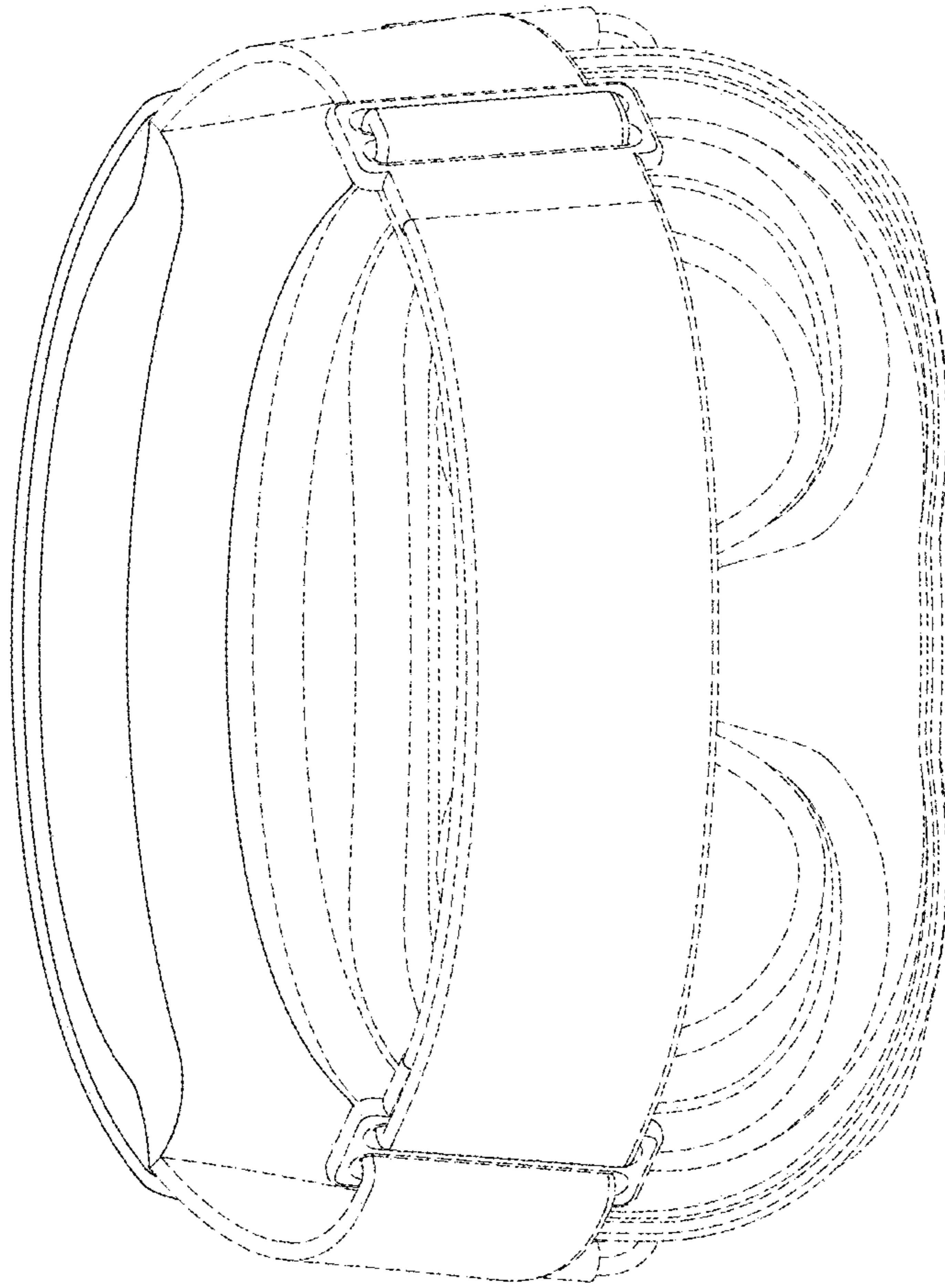

FIG. 3

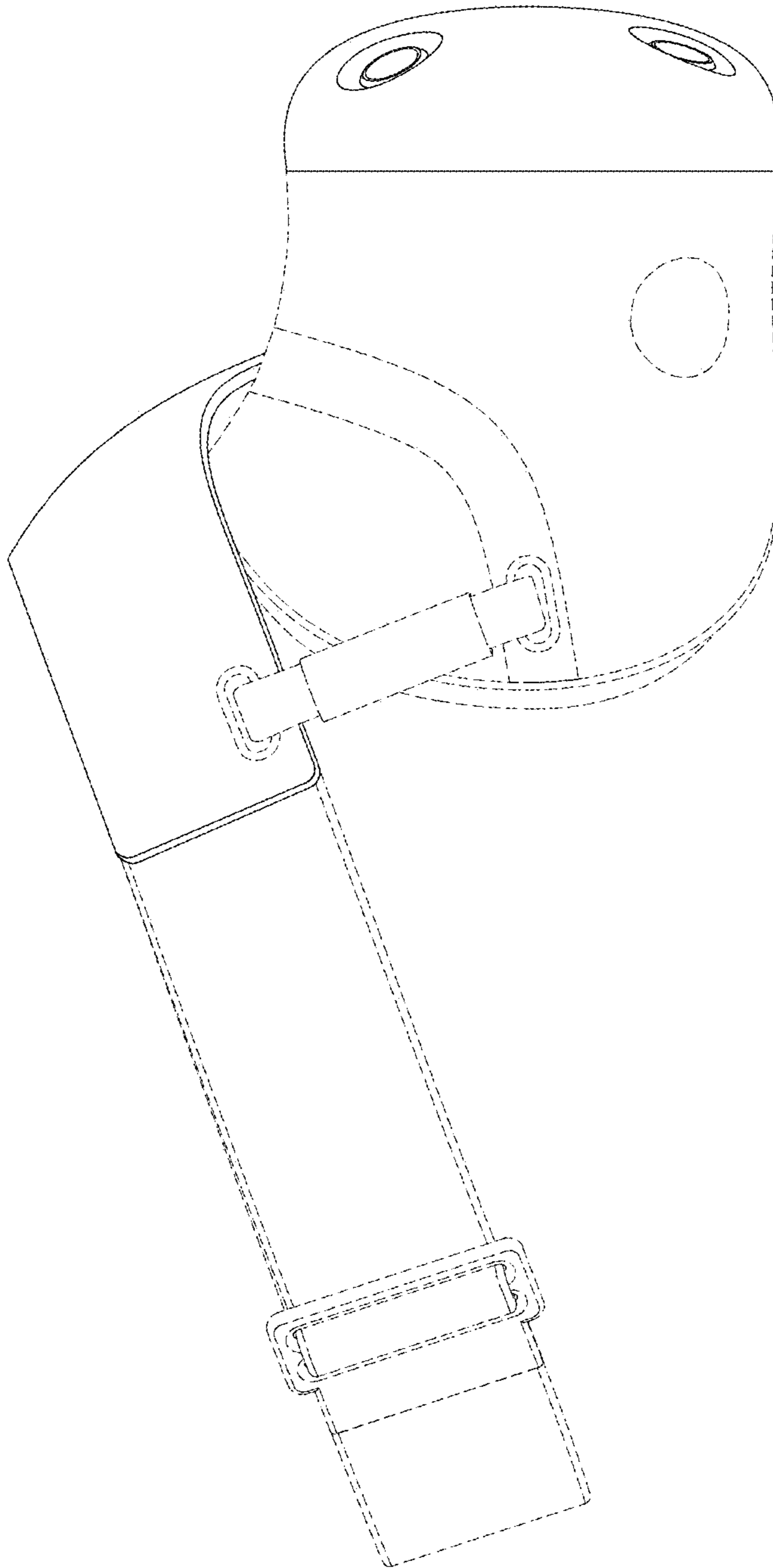

FIG. 4

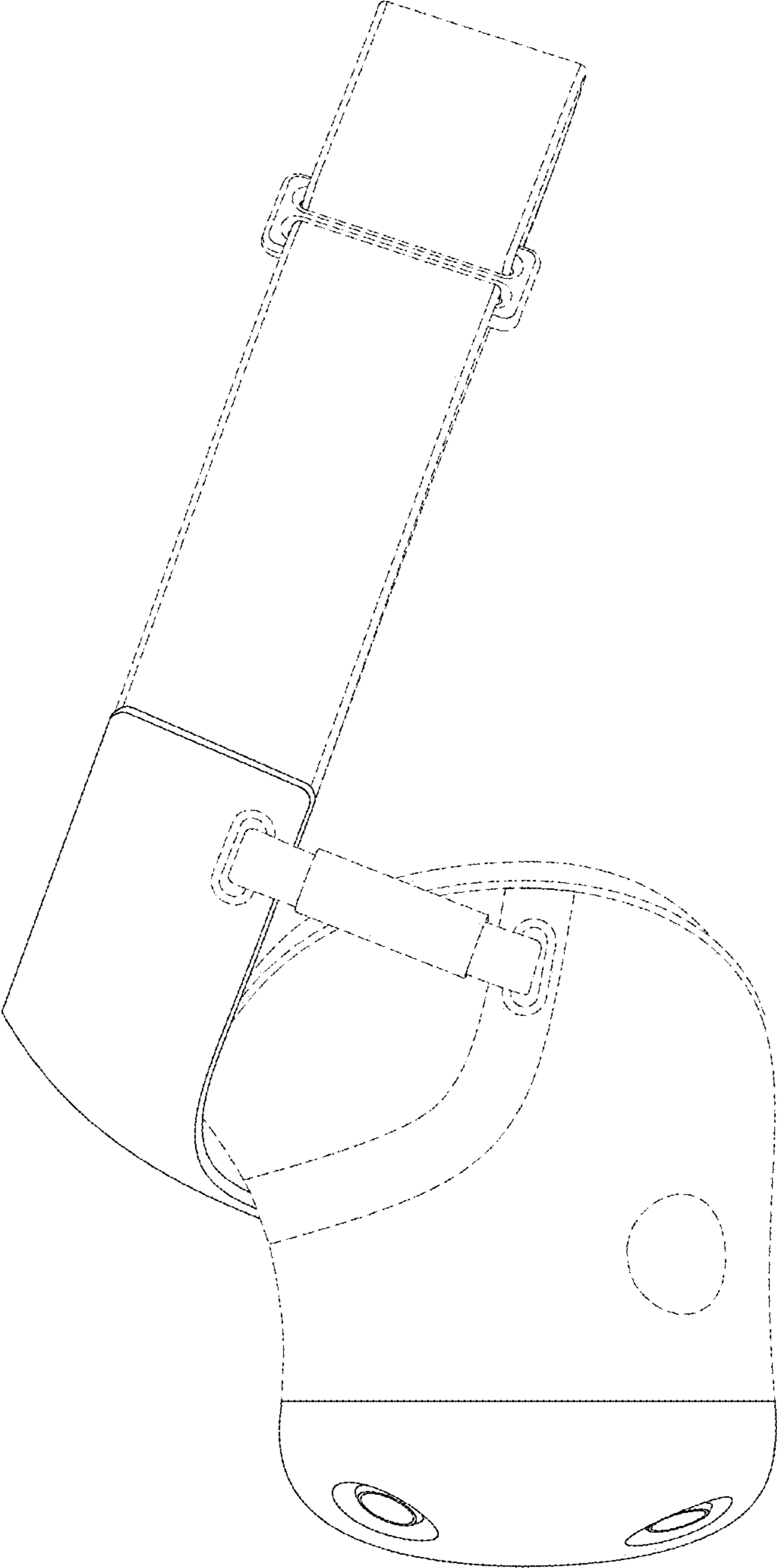

FIG. 5

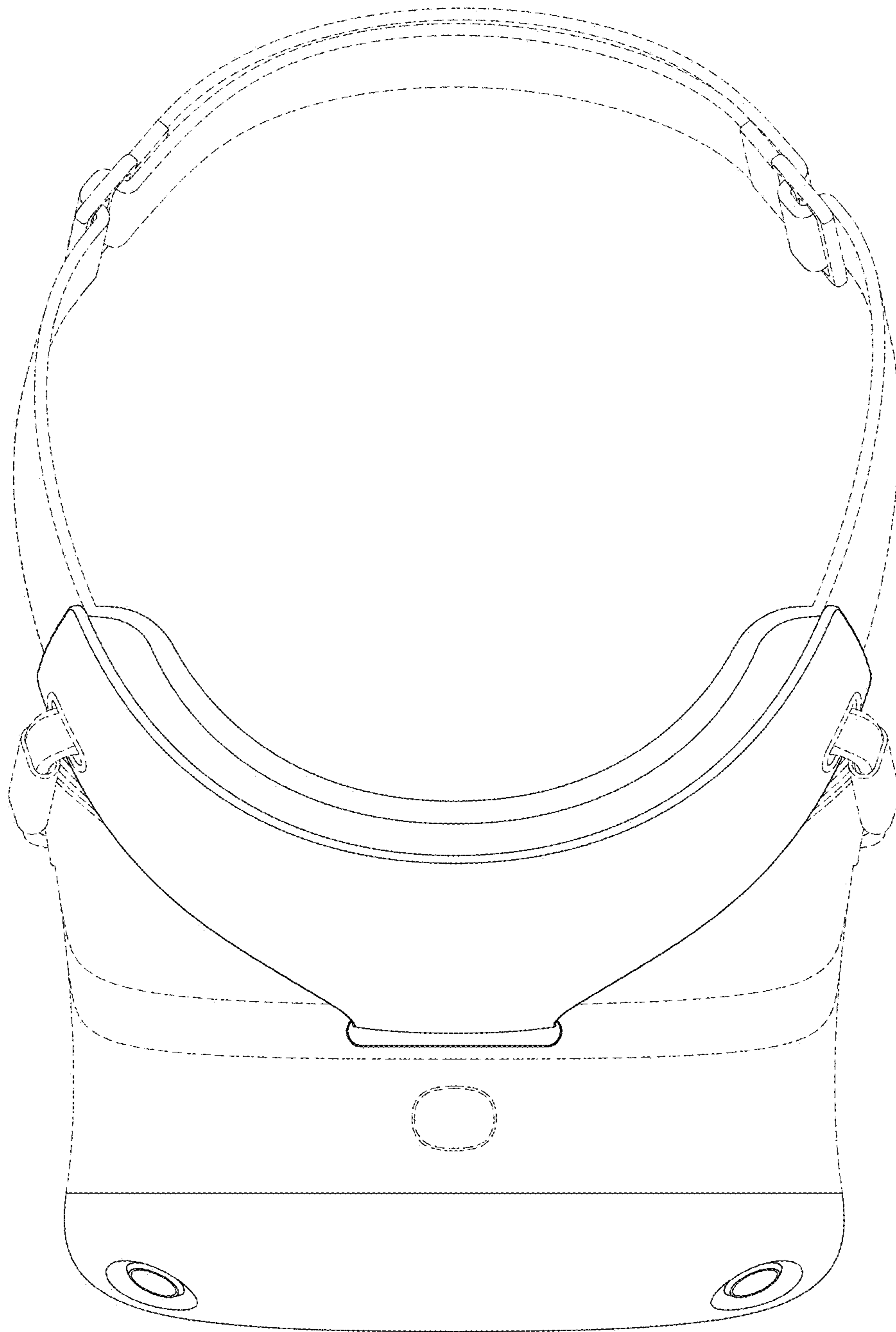

FIG. 6

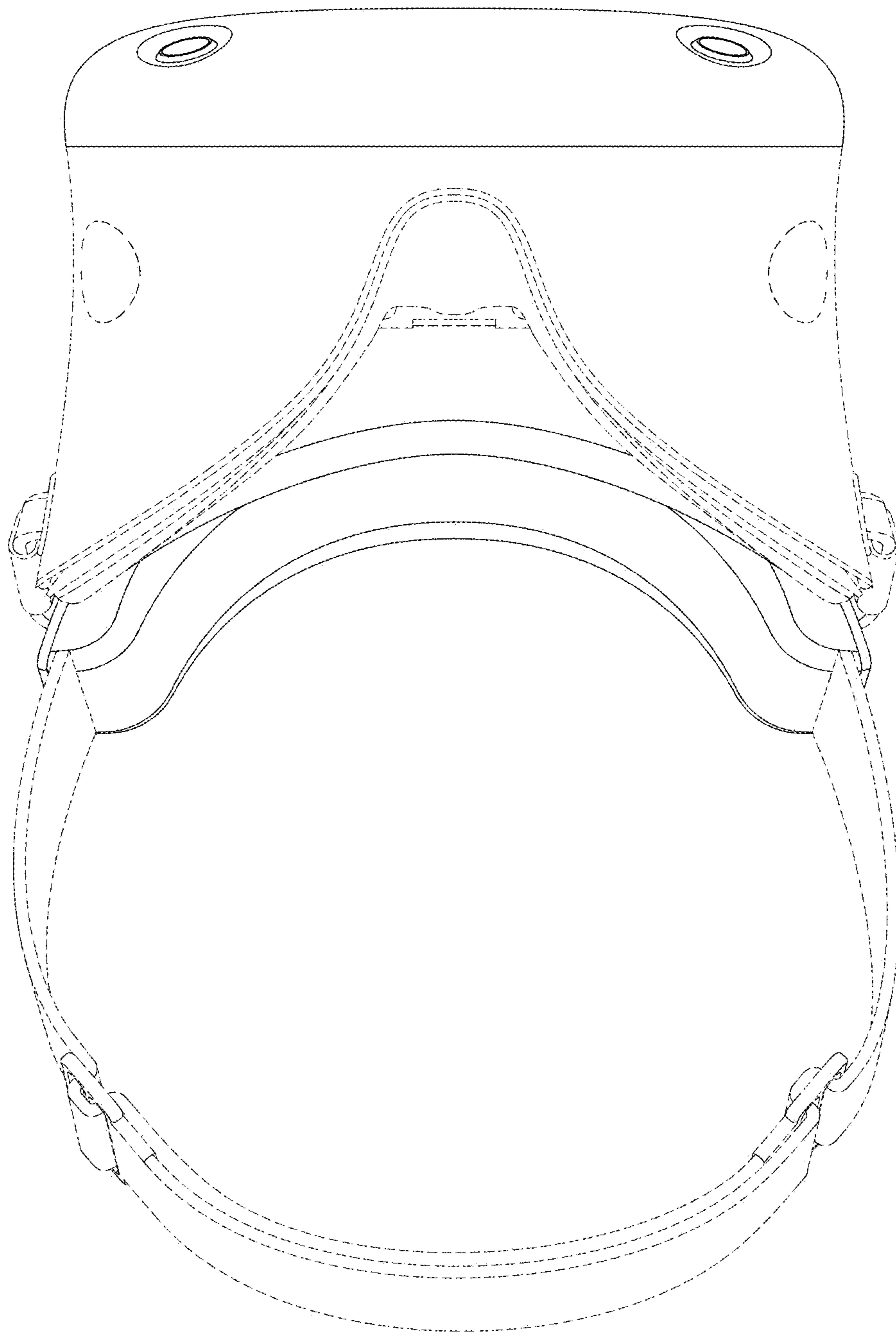

FIG. 7