

US00D951120S

(12) **United States Design Patent**
Murphy

(10) **Patent No.:** **US D951,120 S**

(45) **Date of Patent:** **** May 10, 2022**

- (54) **BARRICADE**
- (71) Applicant: **Scott M. Murphy**, Bloomington, IL
(US)
- (72) Inventor: **Scott M. Murphy**, Bloomington, IL
(US)
- (**) Term: **15 Years**
- (21) Appl. No.: **29/739,875**
- (22) Filed: **Jun. 30, 2020**
- (51) **LOC (13) Cl.** **10-05**
- (52) **U.S. Cl.**
USPC **D10/113.3**
- (58) **Field of Classification Search**
USPC D10/109.1, 111, 113.3, 113.4; D25/38.1,
D25/48.5, 48.8; D6/332
CPC E01F 13/022; E01F 13/00; E01F 13/02;
E01F 13/04
See application file for complete search history.

7,445,403	B2 *	11/2008	Williams	E02B 3/16 404/6
D613,079	S *	4/2010	Tsuchiyama	D6/332
D631,977	S *	2/2011	Taylor	D25/38.1
D642,390	S *	8/2011	West	D6/332
D662,329	S *	6/2012	Arko	D6/332
8,313,265	B2 *	11/2012	Taylor	E02B 3/108 405/114
D696,791	S *	12/2013	Taylor	D25/38.1
8,864,411	B2 *	10/2014	Taylor	E02B 3/108 405/114
9,004,815	B2 *	4/2015	Taylor	E02B 3/106 405/114
D782,957	S *	4/2017	Dall'Era	D12/416
D836,214	S *	12/2018	van Vlastuin	D25/38.1
D931,496	S *	9/2021	Melin	D25/38.1
2004/0114997	A1 *	6/2004	Stone	E01F 9/553 404/16

* cited by examiner

Primary Examiner — George D. Kirschbaum
Assistant Examiner — Lillian Windham
(74) *Attorney, Agent, or Firm* — Philip L. Bateman

(57) **CLAIM**

The ornamental design for a barricade, as shown and described.

DESCRIPTION

FIG. 1 is a front and right side isometric view of a barricade showing my new design;
FIG. 2 is a top plan view thereof;
FIG. 3 is a bottom plan view thereof;
FIG. 4 is a front elevation view thereof;
FIG. 5 is a rear elevation view thereof;
FIG. 6 is a left side elevation view thereof; and,
FIG. 7 is a right side elevation view thereof.

1 Claim, 2 Drawing Sheets

- (56) **References Cited**
U.S. PATENT DOCUMENTS
D53,528 S * 7/1919 Rockwell D25/48.8
D236,818 S * 9/1975 Stenemann D10/111
D260,742 S * 9/1981 Mihailoff D10/109.1
D273,281 S * 4/1984 Mihailoff D10/113.3
D363,789 S * 10/1995 Weid D25/38.1
D400,737 S * 11/1998 DePottay D6/682.4
D430,316 S * 8/2000 Guertin D25/199
6,505,994 B1 * 1/2003 Attar E01F 9/669
404/16
D482,129 S * 11/2003 Hudoba D25/48.8
D543,637 S * 5/2007 Hesselmann D25/38.1
D574,510 S * 8/2008 Riddell D25/38.1

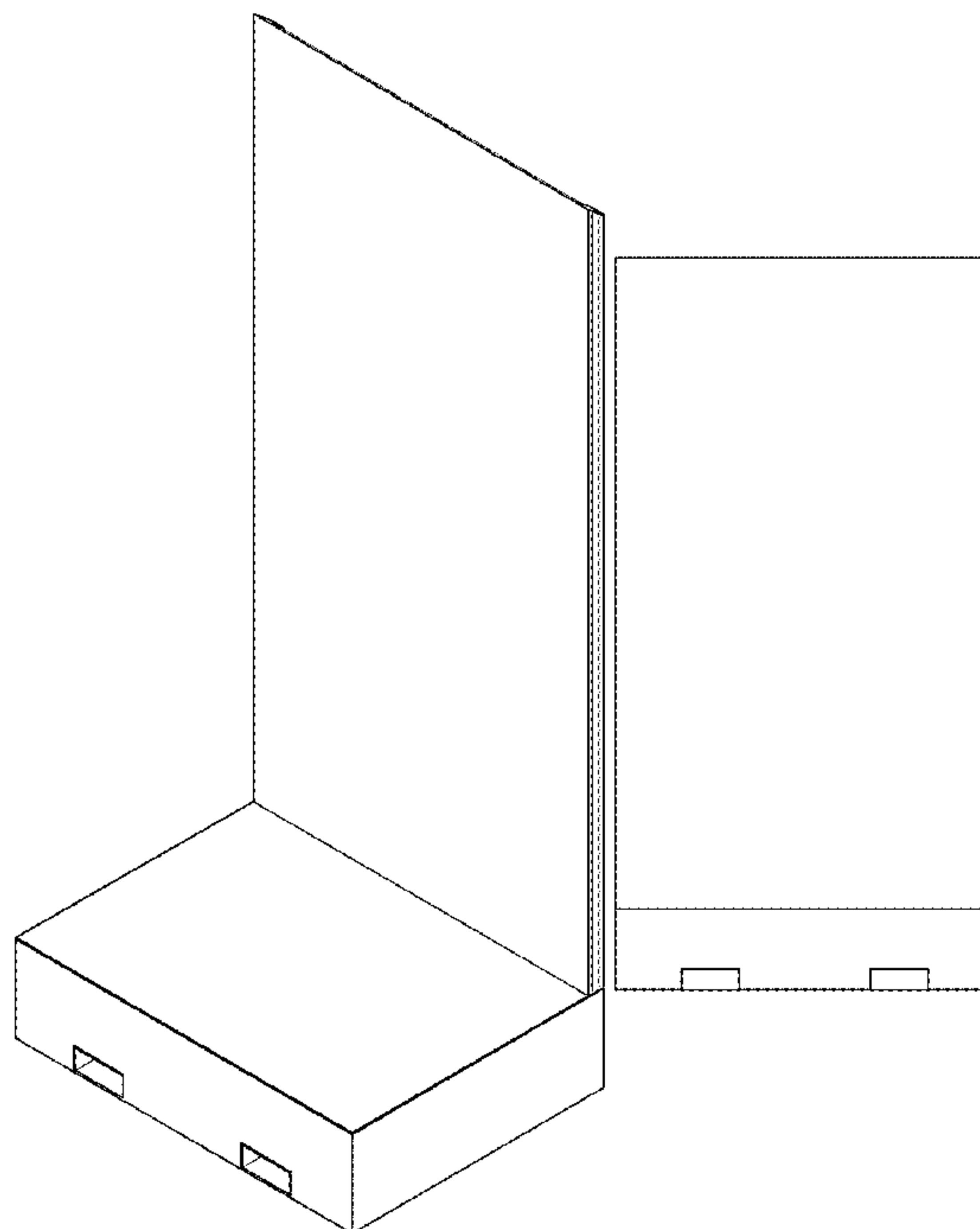

FIG. 1

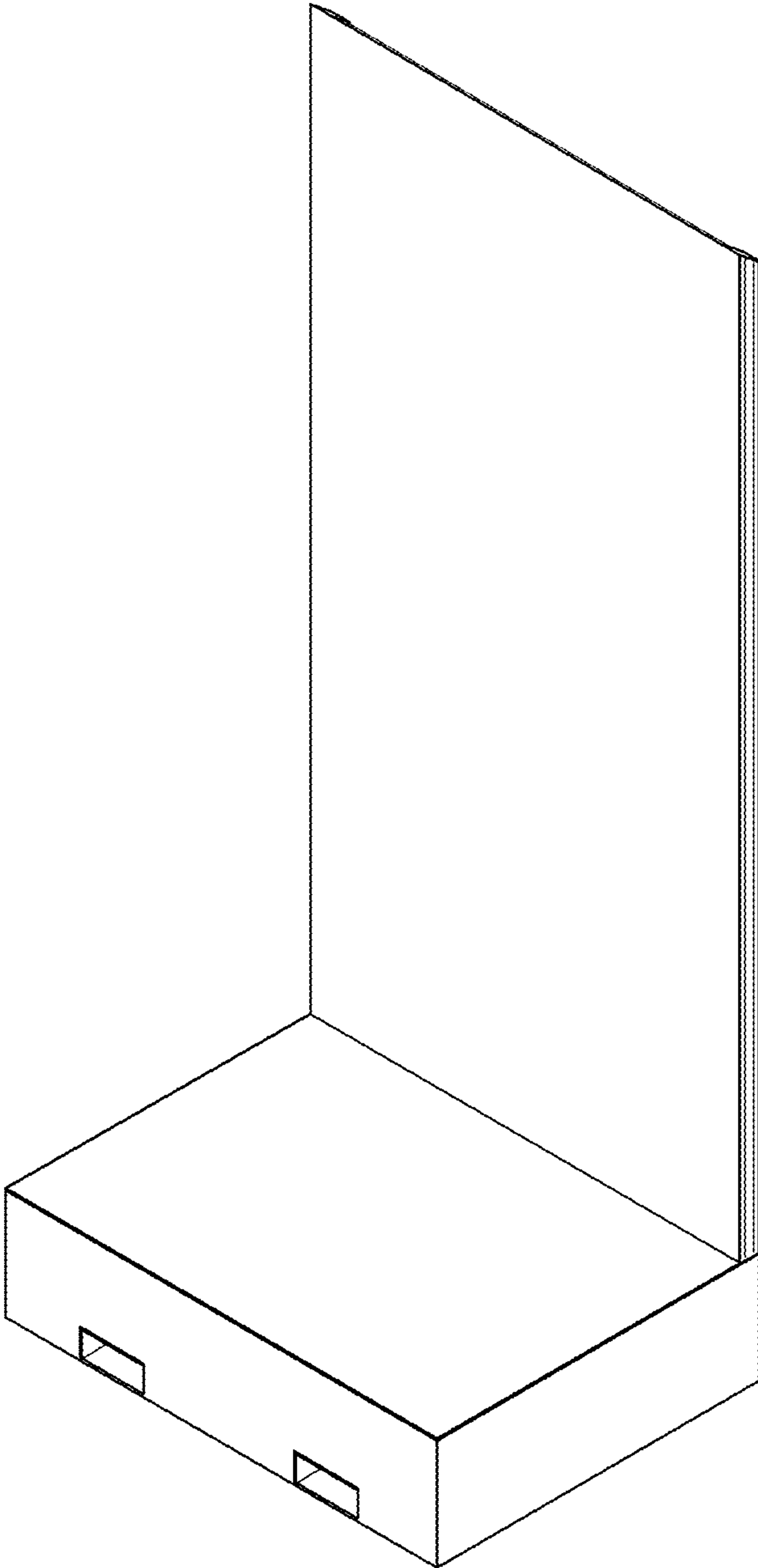

FIG. 2

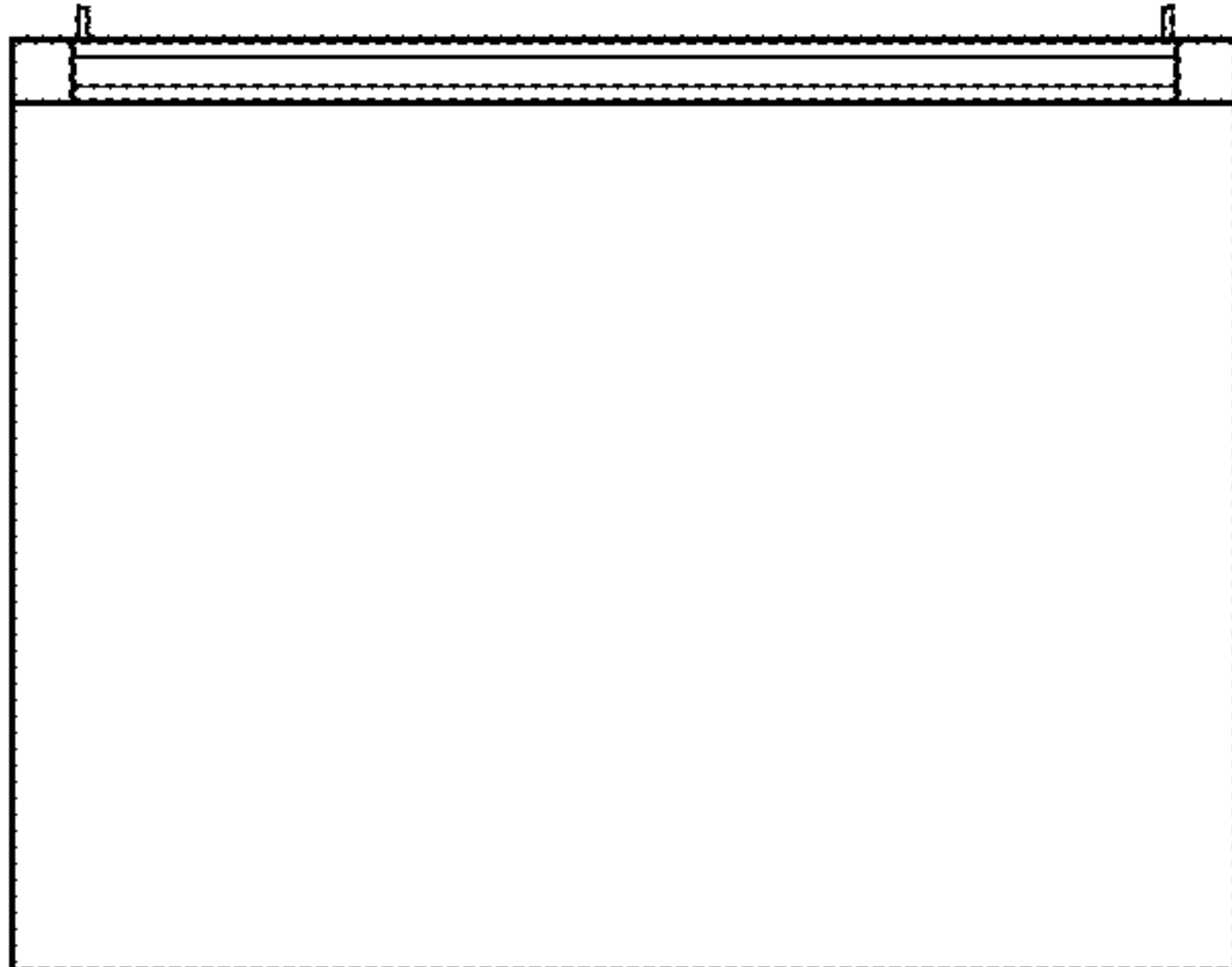

FIG. 3

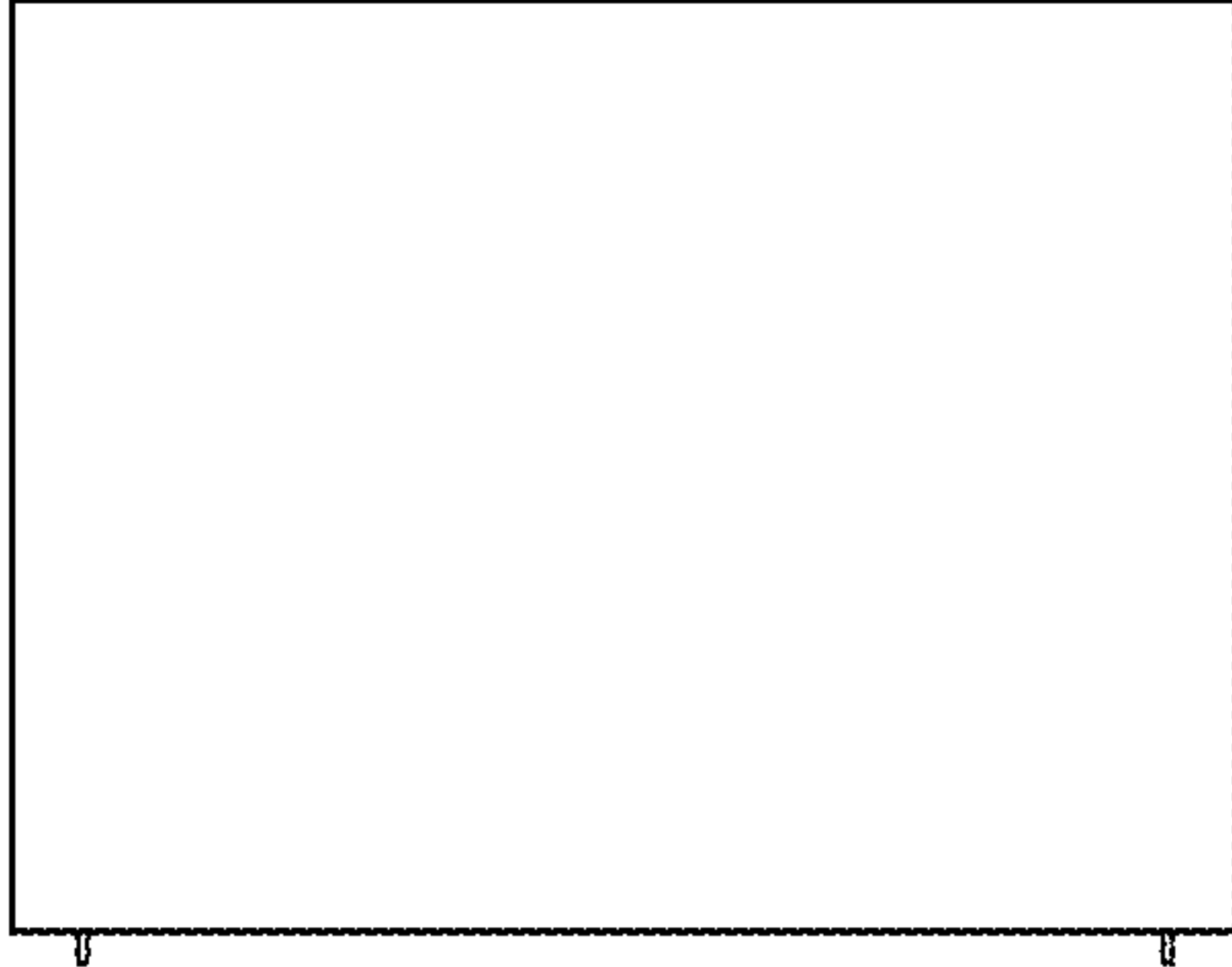

FIG. 4

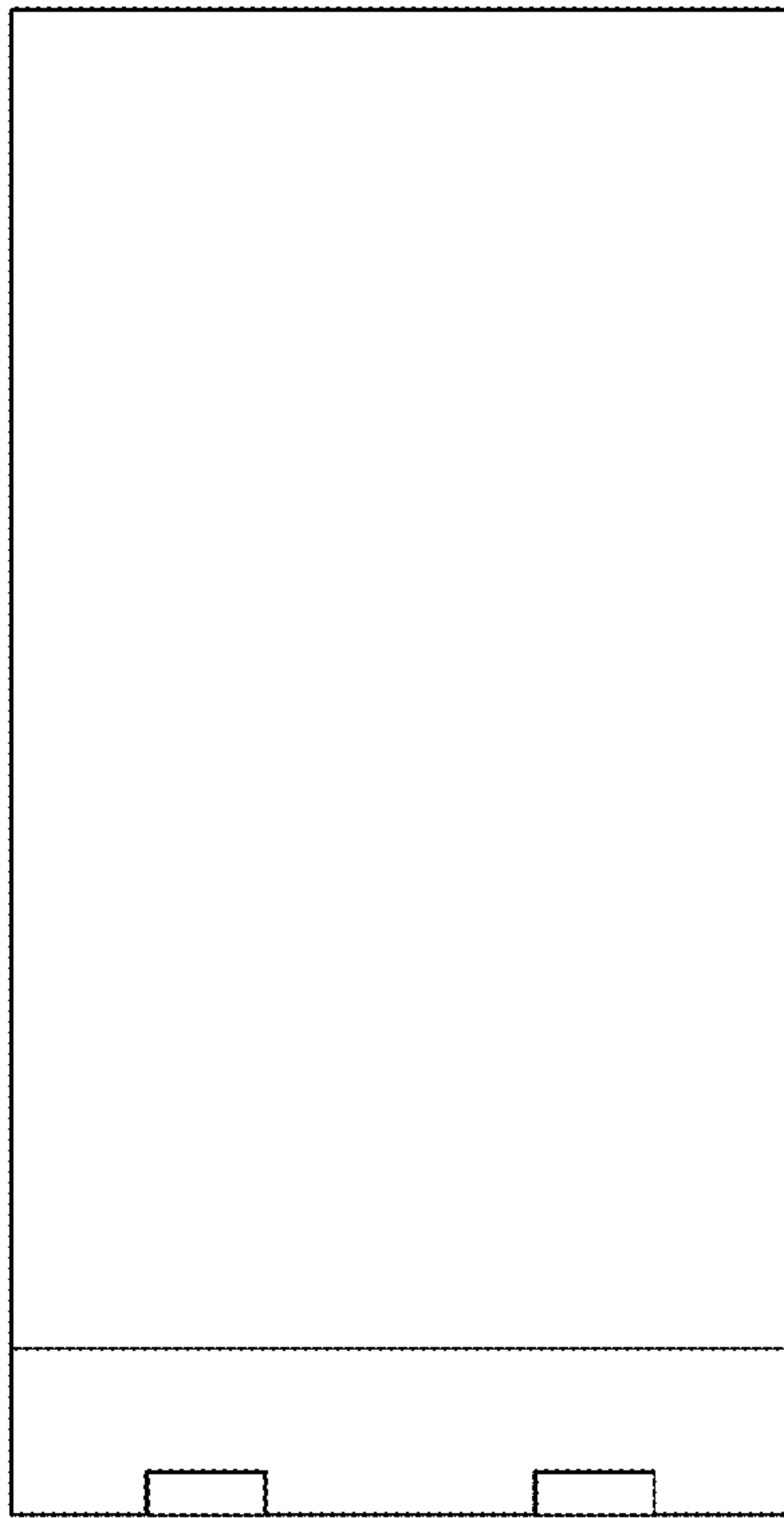

FIG. 5

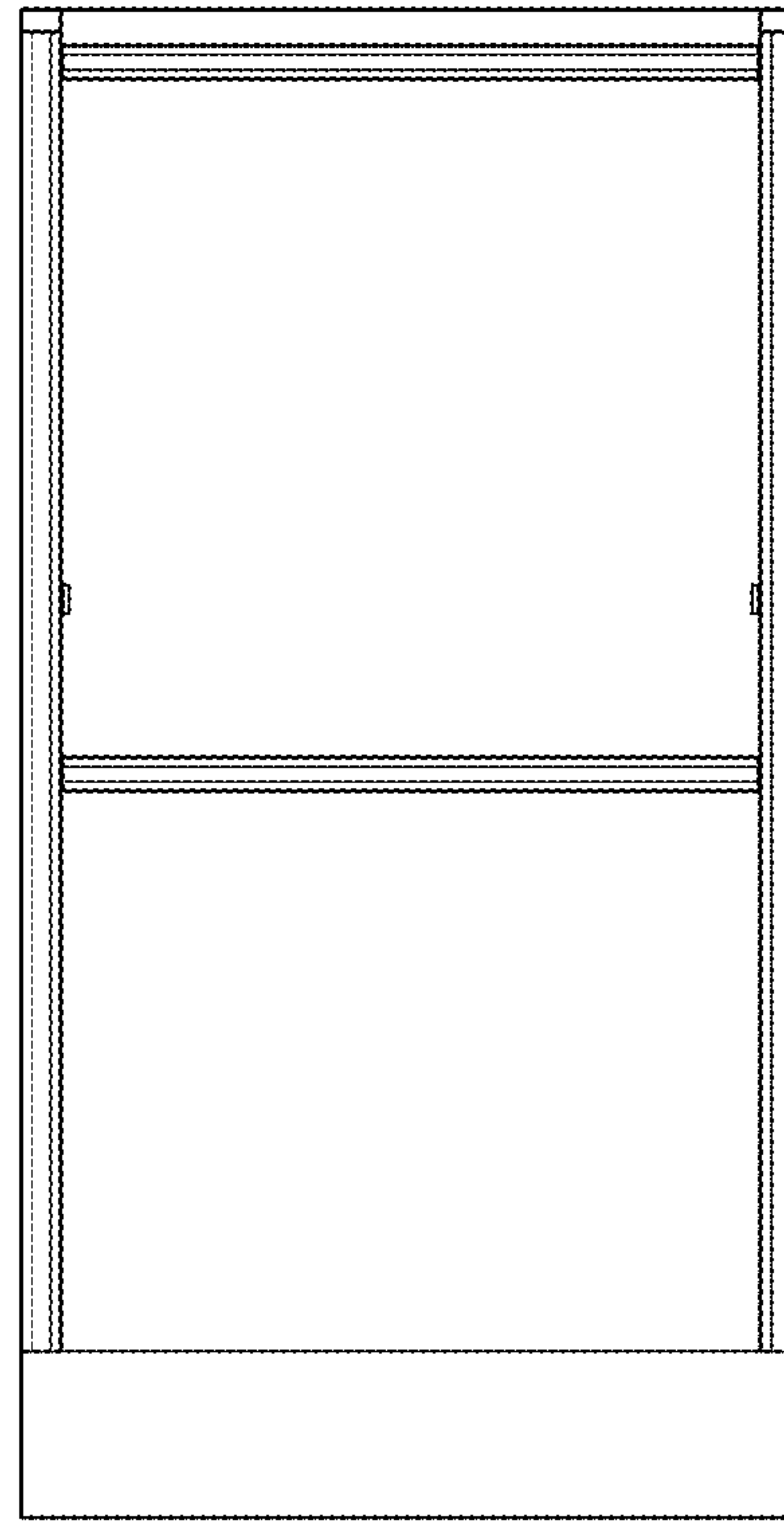

FIG. 6

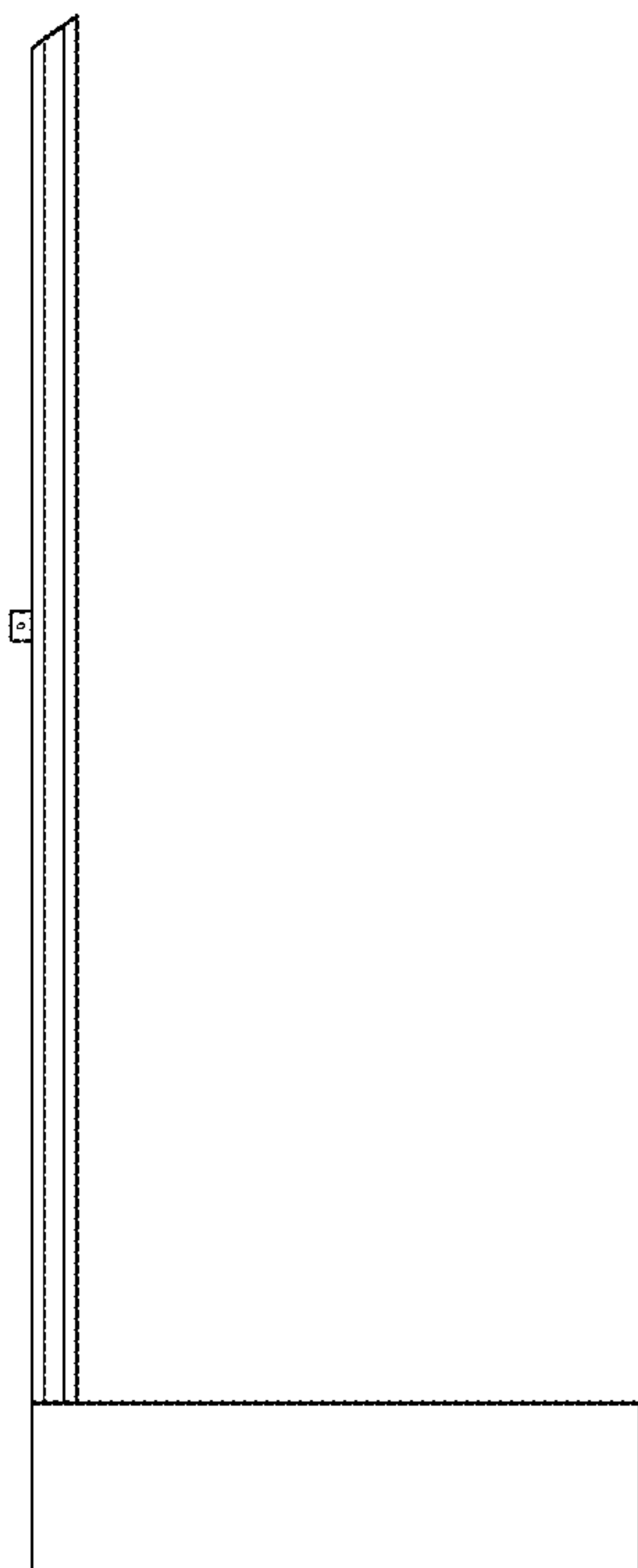

FIG. 7

