



US00D951109S

(12) **United States Design Patent**
Wilson et al.

(10) **Patent No.:** **US D951,109 S**
(45) **Date of Patent:** **** May 10, 2022**

- (54) **TEST BOX**
- (71) Applicant: **Communications Test Design, Inc.**,
West Chester, PA (US)
- (72) Inventors: **Christopher Wilson**, Newark, DE
(US); **John Goldman**, Elverson, PA
(US)
- (73) Assignee: **Communication Test Design, Inc.**,
West Chester, PA (US)
- (**) Term: **15 Years**
- (21) Appl. No.: **29/748,164**
- (22) Filed: **Aug. 27, 2020**
- (51) **LOC (13) Cl.** **10-07**
- (52) **U.S. Cl.**
USPC **D10/46**
- (58) **Field of Classification Search**
USPC D10/46, 49, 75, 103; D13/162.1;
D14/160, 161, 168, 313, 496
CPC G01R 29/0835
See application file for complete search history.

- 7,323,884 B2 * 1/2008 Stojcevic G01R 29/105
324/627
- D574,737 S * 8/2008 Shimada G01R 29/105
D10/46
- 7,839,136 B1 * 11/2010 John G01R 29/0835
324/96
- D640,577 S * 6/2011 Libman H04N 17/004
D10/49
- 8,418,219 B1 * 4/2013 Parsons H04N 17/004
348/181
- D771,509 S * 11/2016 Besett G01R 29/0835
D10/75
- 10,188,207 B2 * 1/2019 Parsons H04M 1/24
- D842,144 S * 3/2019 Blier H04M 1/24
D10/75
- D860,009 S * 9/2019 Furukawa H04M 1/24
D10/49
- D861,517 S * 10/2019 Apenburg D10/75
- 10,483,636 B1 * 11/2019 Koto H04B 17/20

(Continued)

Primary Examiner — George D. Kirschbaum
Assistant Examiner — Lillian Windham
(74) *Attorney, Agent, or Firm* — Duane Morris LLP

(57) **CLAIM**

We claim the ornamental design for a test box, as shown and described.

DESCRIPTION

FIG. 1 is a perspective view of a test box showing our new design.
FIG. 2 is a front elevational view of the test box.
FIG. 3 is a rear elevational view of the test box.
FIG. 4 is a right side elevational view of the test box.
FIG. 5 is a left side elevational view of the test box.
FIG. 6 is a top plan view of the test box; and,
FIG. 7 is a bottom plan view of the test box.
The broken lines in the drawings are included for the purpose of illustrating portions of the test box and form no part of the claimed design.

1 Claim, 4 Drawing Sheets

(56) **References Cited**

U.S. PATENT DOCUMENTS

- D161,636 S * 1/1951 Manning D10/46
- D284,279 S * 6/1986 Ishii D14/161
- D314,919 S * 2/1991 Villar D10/46
- D322,439 S * 12/1991 Wilson D10/46
- 5,323,298 A * 6/1994 Shatas H05K 9/0062
174/385
- D355,616 S * 2/1995 Gregg, III H05K 9/0062
D10/46
- D377,319 S * 1/1997 Amano D10/76
- D427,533 S * 7/2000 Cowan D10/75
- D429,470 S * 8/2000 Hackenbroich D10/46
- D450,000 S * 11/2001 Van D10/46
- D520,385 S * 5/2006 Abe D10/46

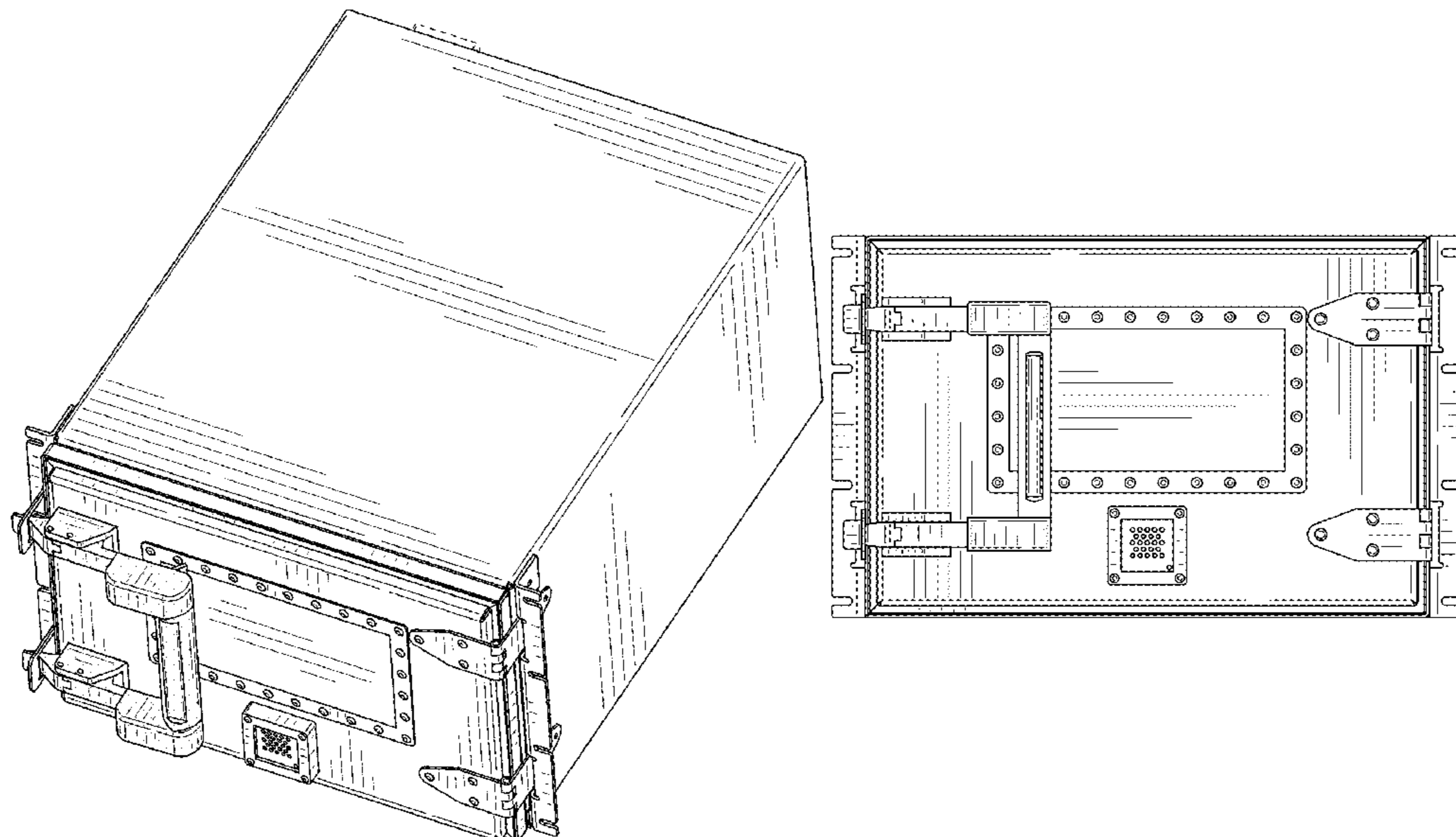

(56)

References Cited

U.S. PATENT DOCUMENTS

10,520,532 B2 *	12/2019	Lee	G01R 29/26
D878,222 S *	3/2020	Furukawa	G01R 29/26
				D10/49
10,897,840 B2 *	1/2021	Yang	H05K 5/0052
D934,091 S *	10/2021	Wang	H05K 5/0052
				D10/46
D934,704 S *	11/2021	Reiner	H05K 5/0052
				D10/49
2013/0002235 A1 *	1/2013	He	G01R 1/04
				324/121 R
2016/0187876 A1 *	6/2016	Diperna	H04B 17/29
				702/81

* cited by examiner

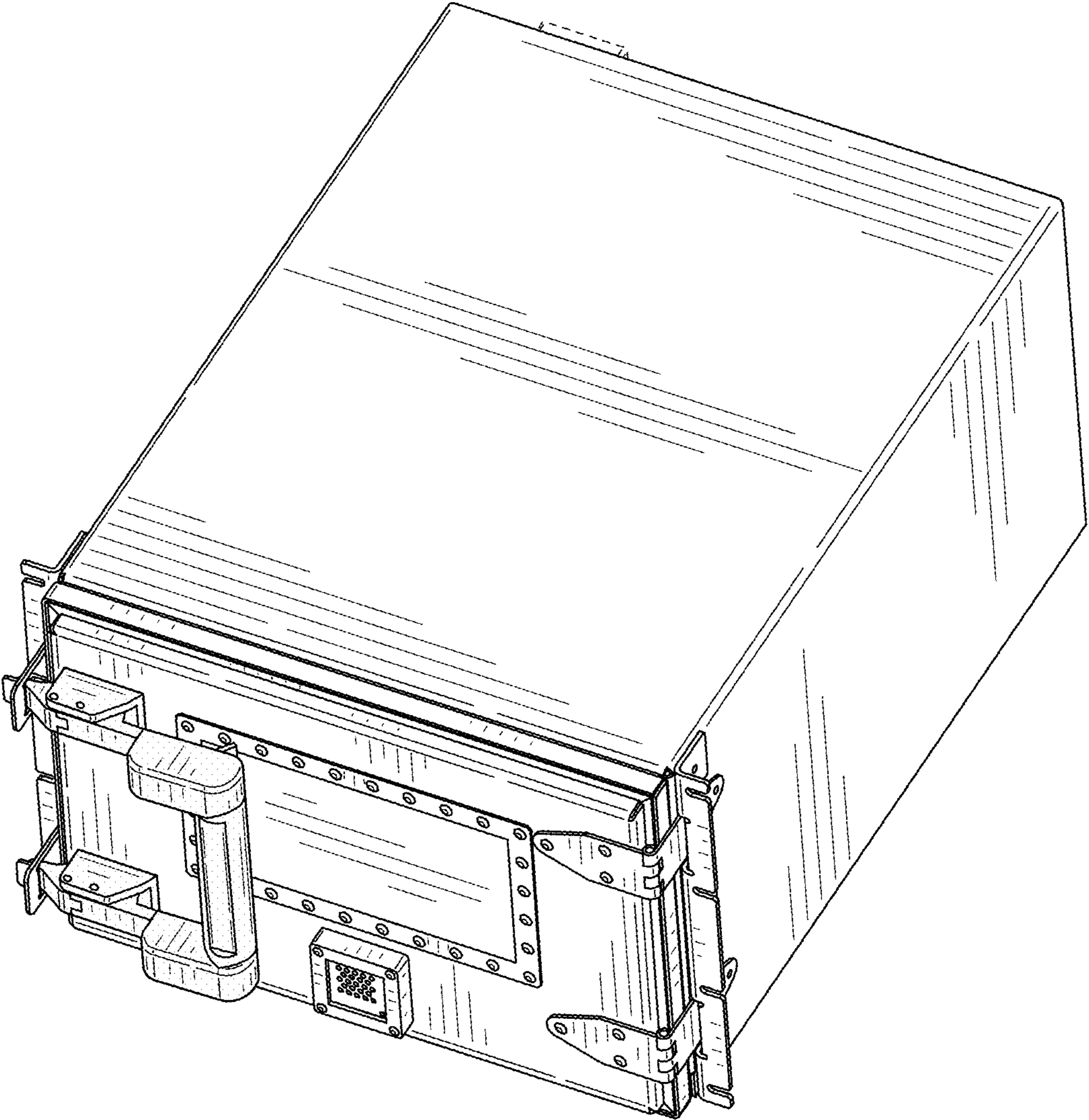

FIG. 1

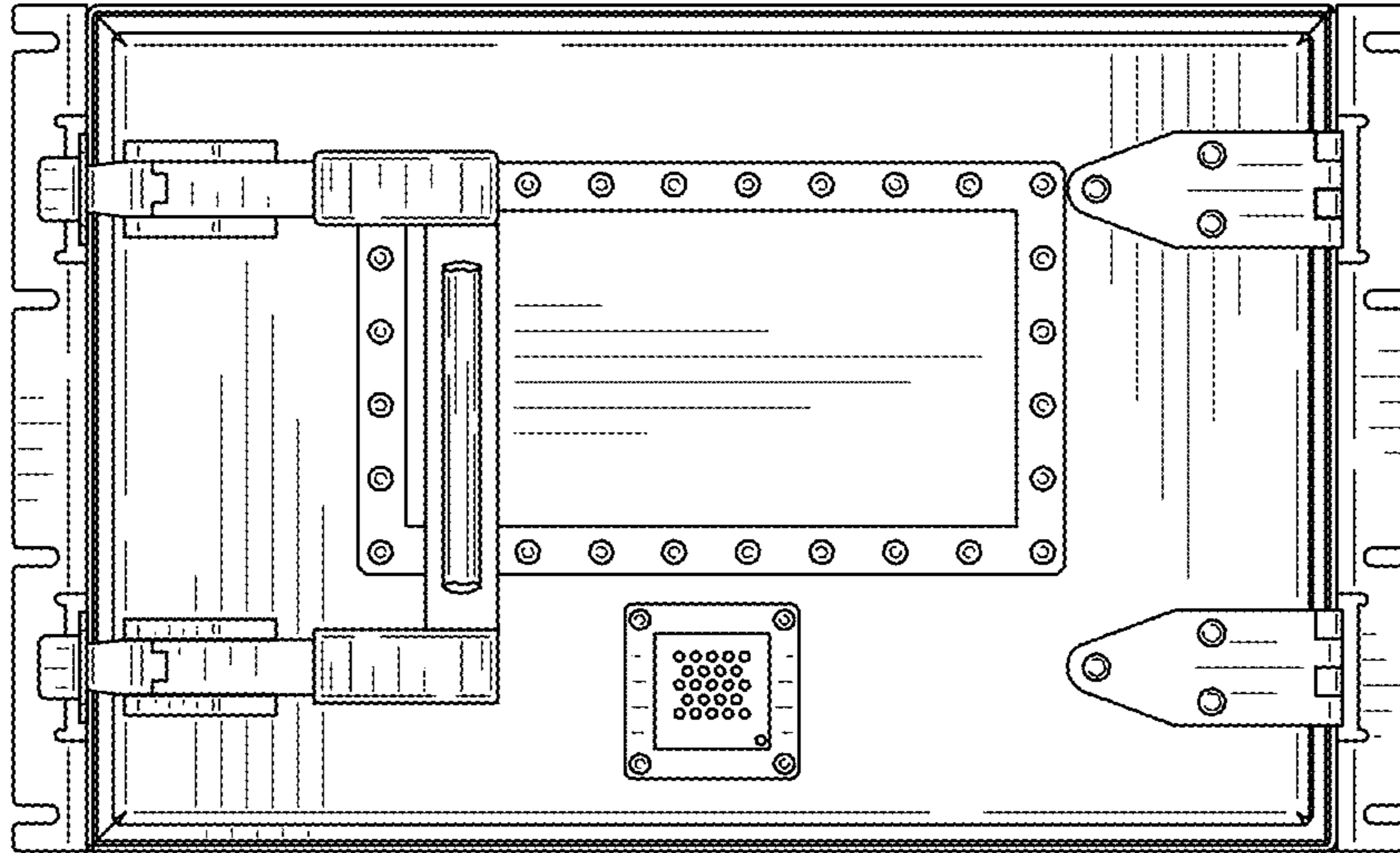

FIG. 2

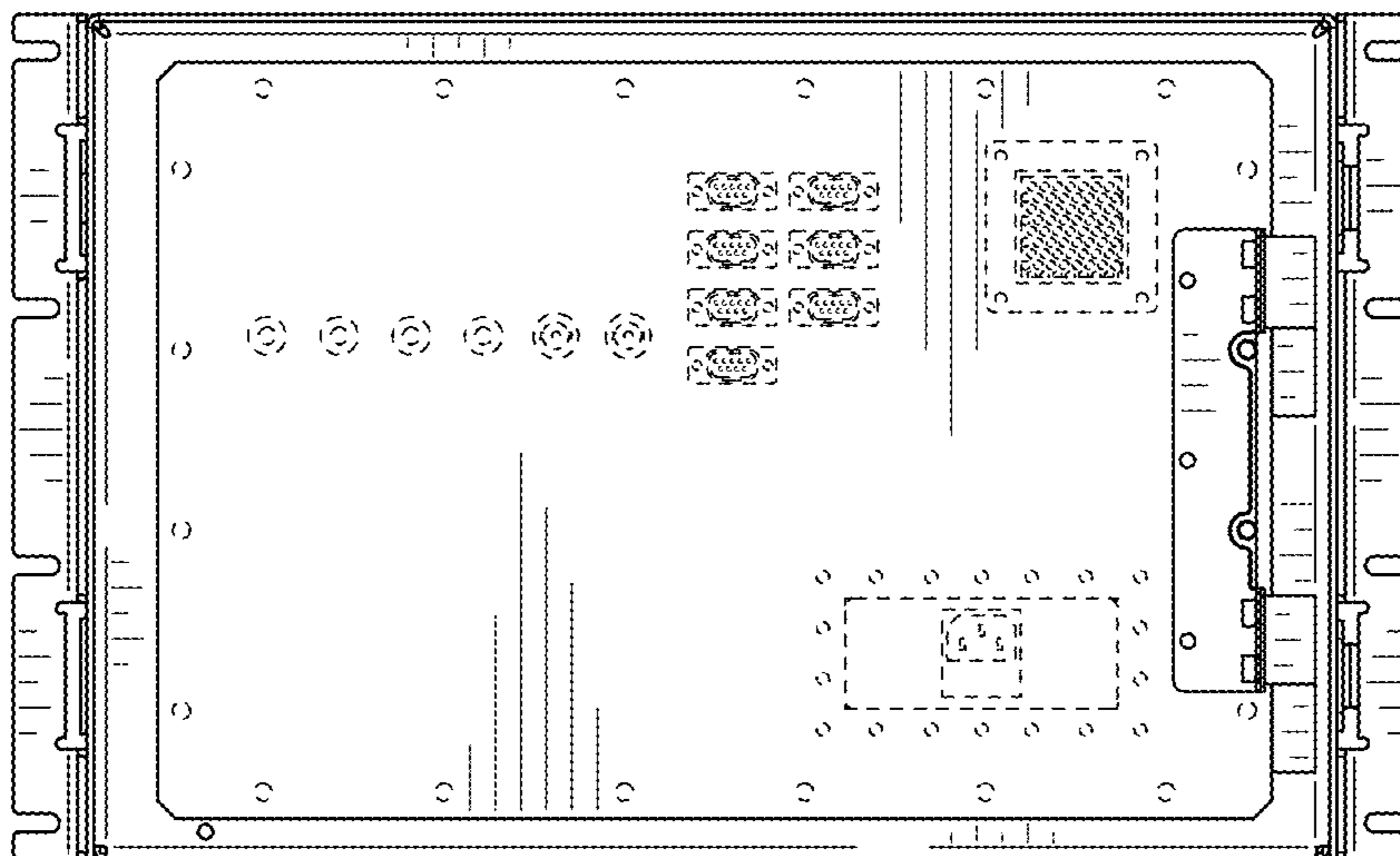

FIG. 3

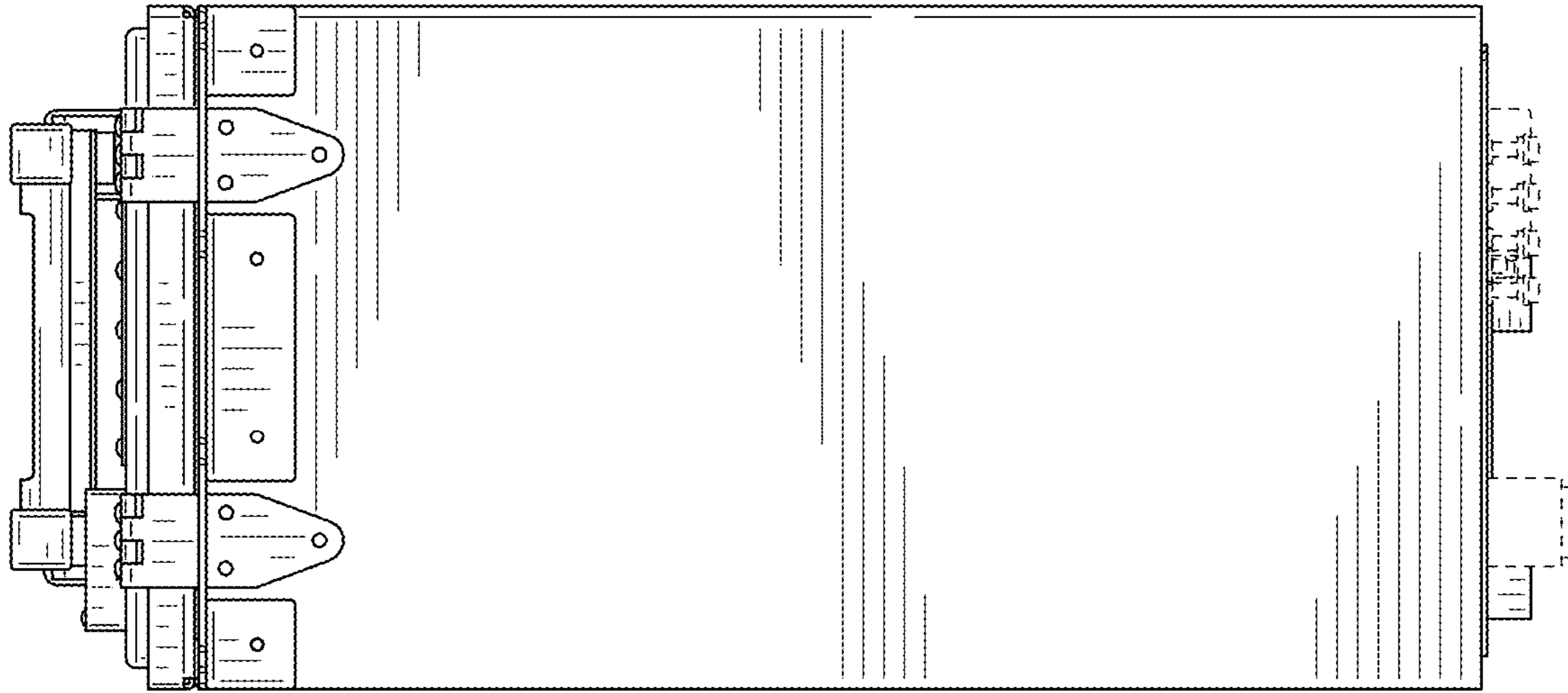

FIG. 4

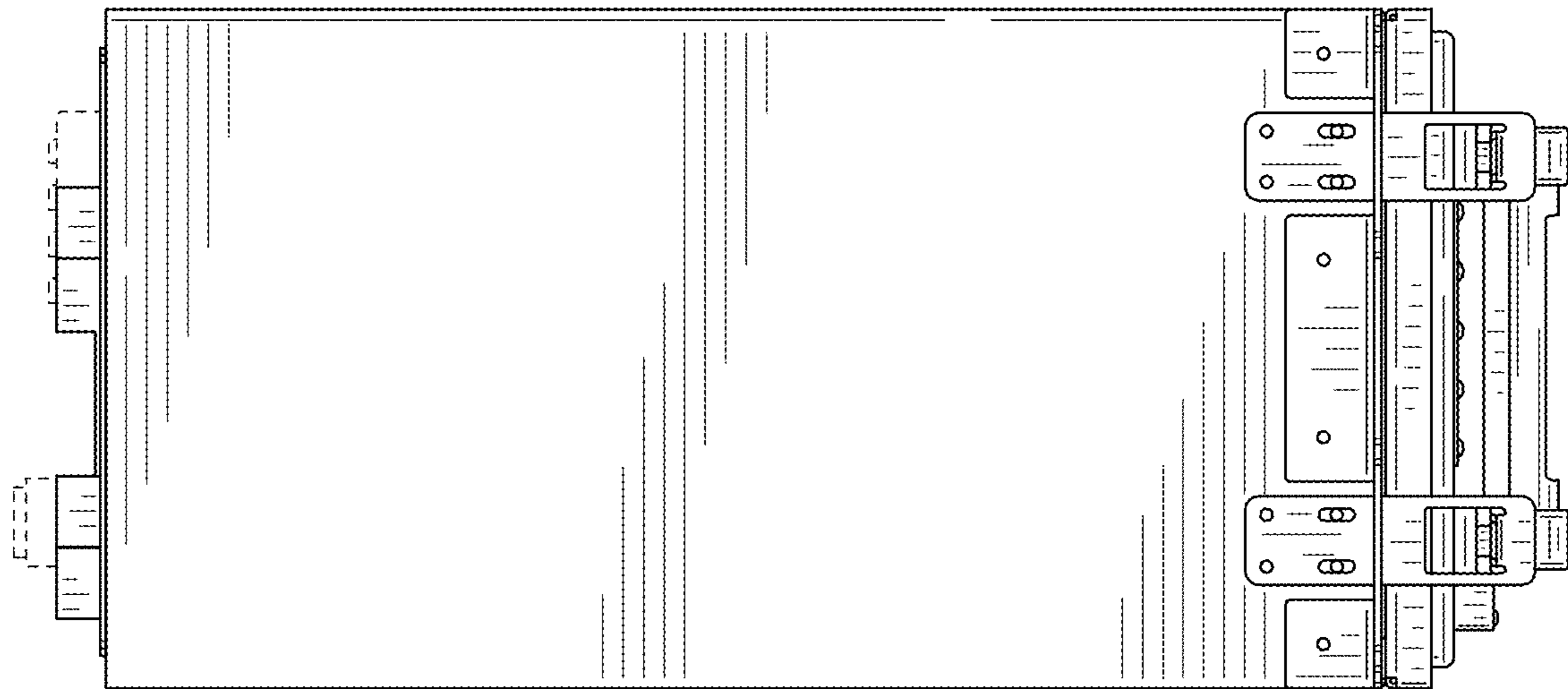

FIG. 5

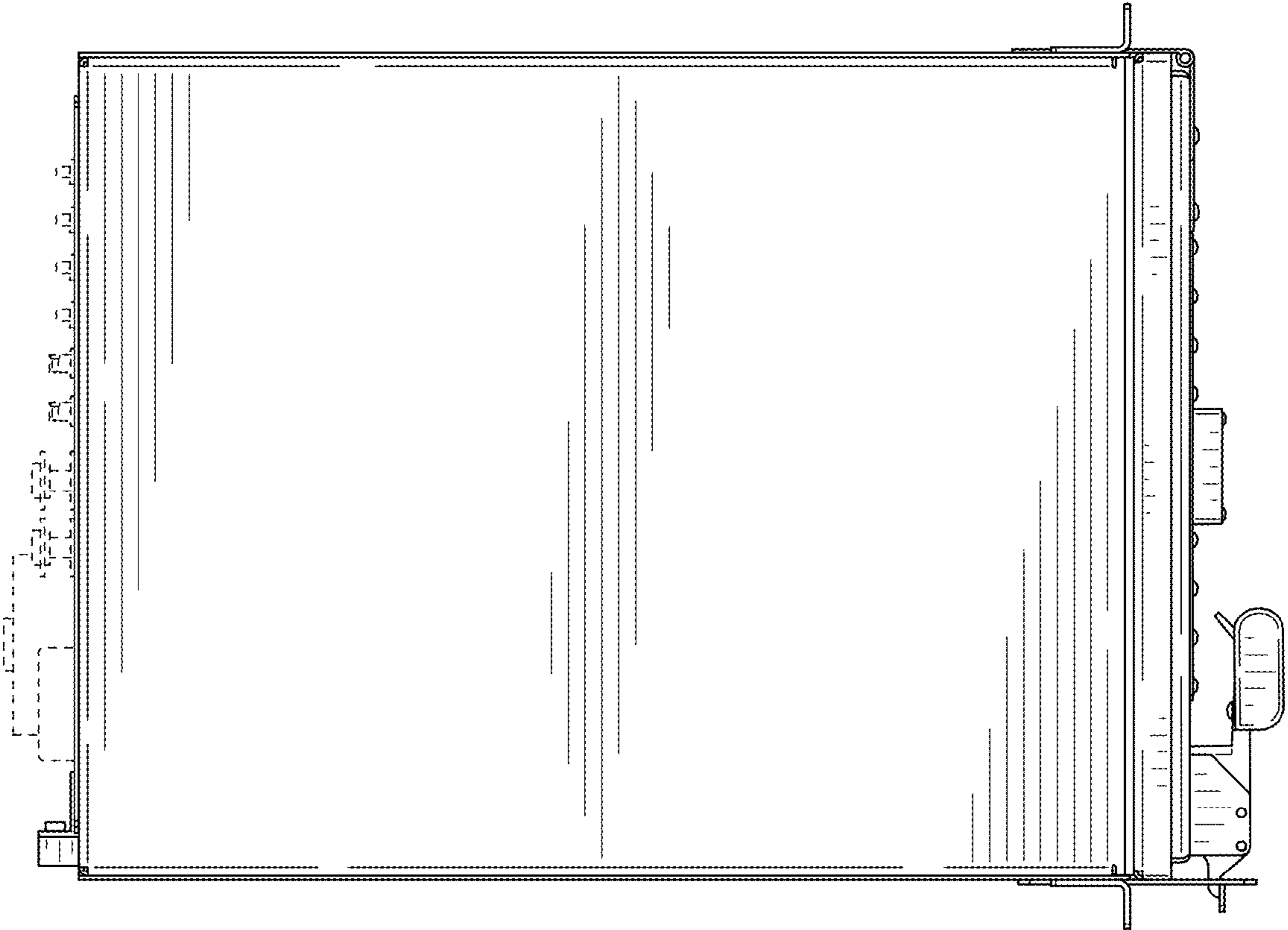

FIG. 6

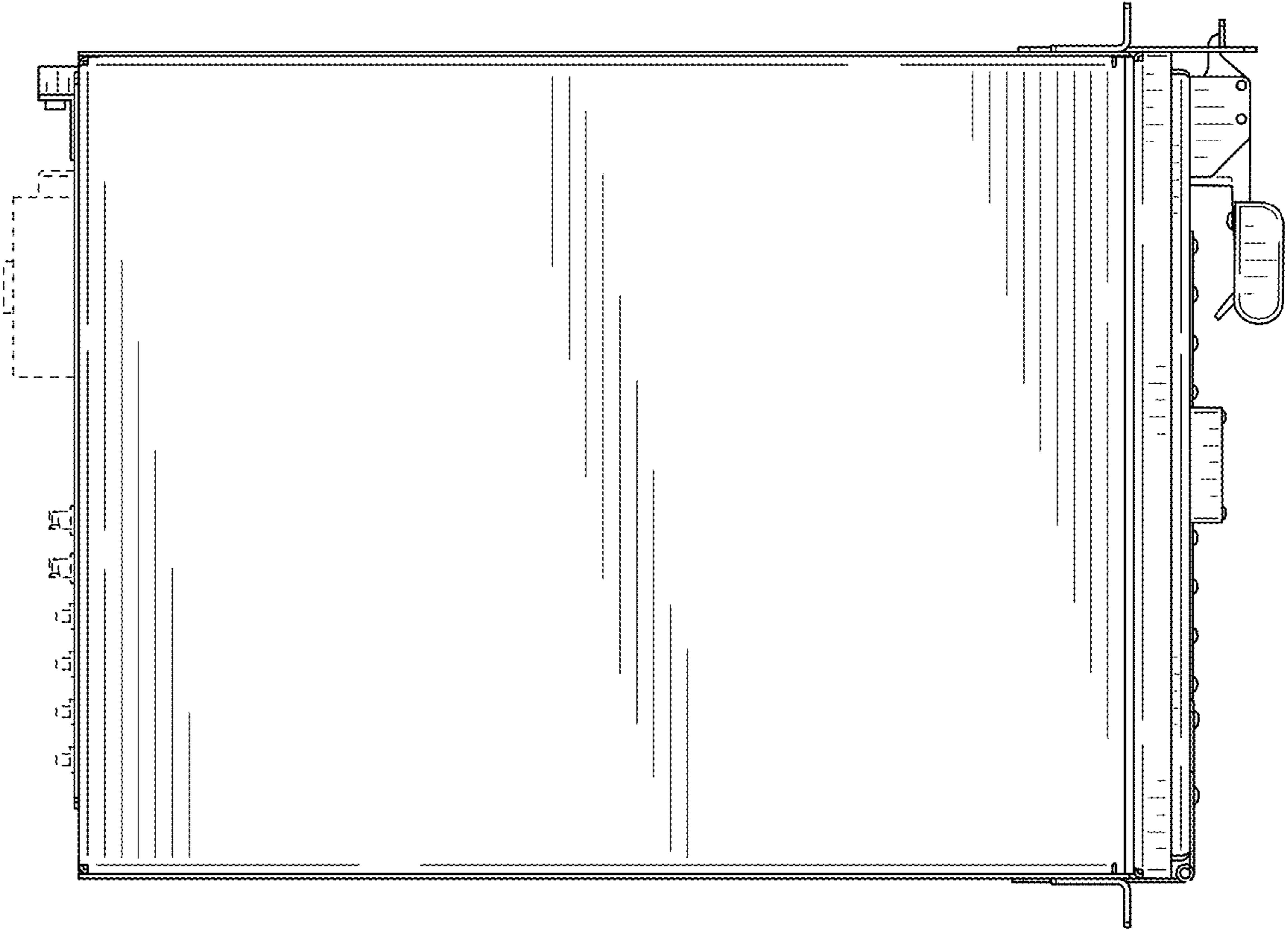

FIG. 7