



US00D951029S

(12) **United States Design Patent** (10) **Patent No.:** **US D951,029 S**  
**Burns et al.** (45) **Date of Patent:** **\*\* May 10, 2022**

(54) **DRINK HOLDER**  
(71) Applicant: **LIFETIME BRANDS, INC.**, Garden City, NY (US)

4,378,625 A 4/1983 Crisman et al.  
4,383,422 A 5/1983 Gordon et al.  
4,577,474 A 3/1986 Peterson  
(Continued)

(72) Inventors: **Clay Allen Burns**, New York, NY (US); **Eric Charles Fleischer**, New York, NY (US)

**FOREIGN PATENT DOCUMENTS**

DE 10214857 10/2003  
*Primary Examiner* — Joseph Kukella  
*Assistant Examiner* — Darryl J Dardenne  
(74) *Attorney, Agent, or Firm* — Tutunjian & Bitetto, P.C.

(73) Assignee: **Lifetime Brands, Inc.**, Garden City, NY (US)

(\*\*) Term: **15 Years**

(57) **CLAIM**  
The ornamental design for a drink holder, as shown and described.

(21) Appl. No.: **29/733,927**

**DESCRIPTION**

(22) Filed: **May 7, 2020**

(51) **LOC (13) Cl.** ..... **07-07**

(52) **U.S. Cl.**  
USPC ..... **D7/608**

(58) **Field of Classification Search**  
USPC ..... D7/300, 313, 316, 507, 510, 511, 602, D7/605, 608  
CPC .. A47J 43/00; A47J 47/00; A47J 47/02; A47J 47/08; A47G 19/2205; A47G 23/16; A47G 19/2272; A47G 19/2288; A47G 19/23; A45F 3/16; A45F 2200/0583; B65D 1/265; B65D 3/22; B65D 81/3453; B65D 81/3865  
See application file for complete search history.

FIG. 1 is a top isometric view of an embodiment of the drink holder.  
FIG. 2 is a bottom isometric view of the drink holder of FIG. 1.  
FIG. 3 is a front elevation view of the drink holder of FIG. 1.  
FIG. 4 is a rear elevation view of the drink holder of FIG. 1.  
FIG. 5 is a right side elevation view of the drink holder of FIG. 1.  
FIG. 6 is a left side elevation view of the drink holder of FIG. 1.  
FIG. 7 is a top plan view of the drink holder of FIG. 1; and, FIG. 8 is a bottom plan view of the drink holder of FIG. 1. The evenly dotted broken lines in the figures illustrate unclaimed features of the drink holder and form no part of the claimed design. The dash-dot-dot-dash broken lines depict a symbolic break in the drink holder indicating that the appearance of any portion of the drink holder between these break lines forms no part of the claimed design. The dash-dot-dash broken lines shown in FIG. 2 and FIG. 8 depict boundary lines of unclaimed portions of the drink holder that form no part of the claimed design.

(56) **References Cited**

**U.S. PATENT DOCUMENTS**

3,013,691 A 12/1961 Prentice  
3,285,455 A 11/1966 Pewitt  
3,406,532 A 10/1968 Rownd et al.  
4,163,374 A \* 8/1979 Moore ..... F25D 3/08 62/457.4  
4,183,226 A 1/1980 Moore  
4,299,100 A 11/1981 Crisman et al.

**1 Claim, 7 Drawing Sheets**

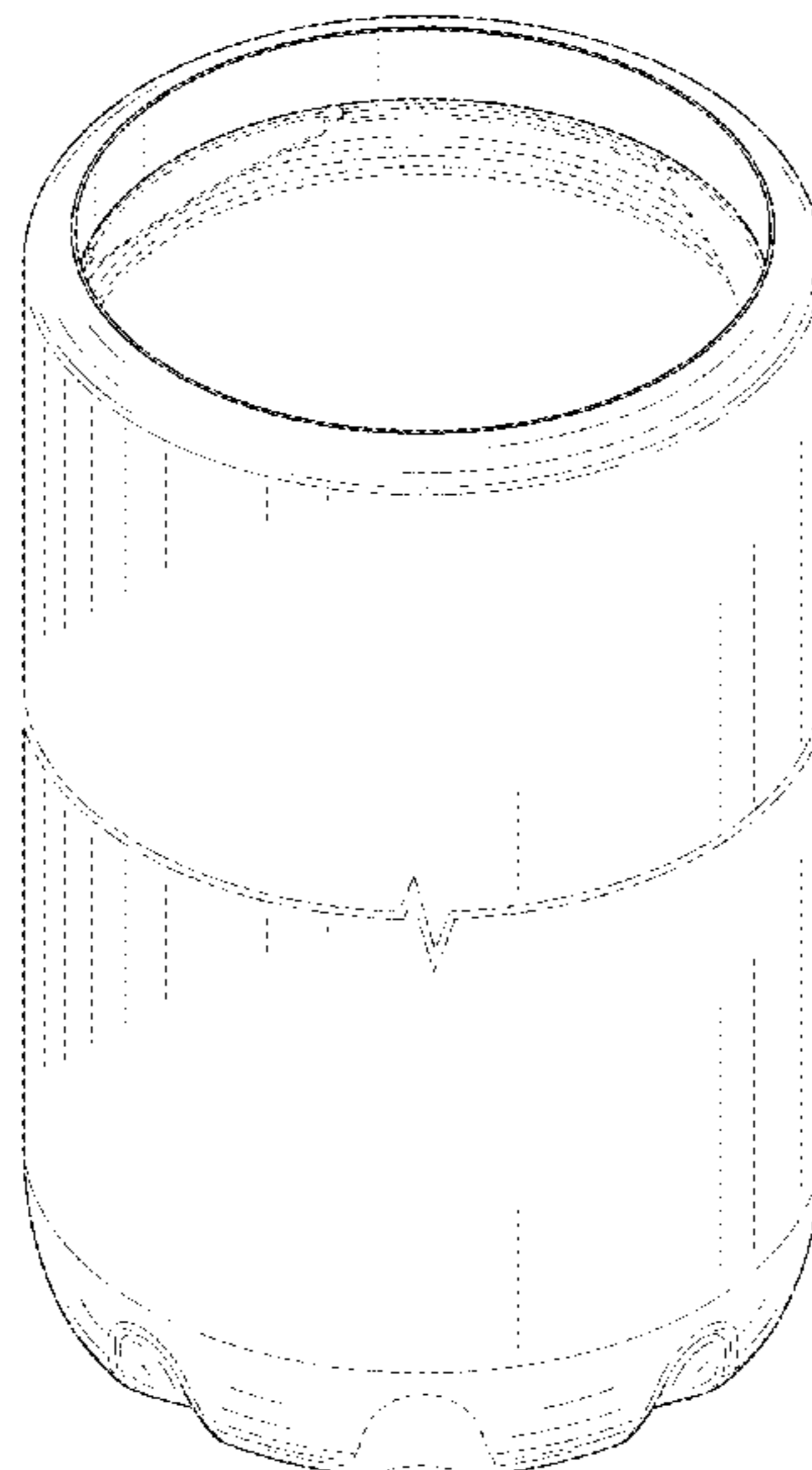

(56)

References Cited

U.S. PATENT DOCUMENTS

4,596,370 A 6/1986 Adkins  
 4,629,153 A 12/1986 Marcum  
 4,681,239 A 7/1987 Manns et al.  
 4,720,023 A 1/1988 Jeff  
 4,741,176 A 5/1988 Johnson et al.  
 4,768,354 A 9/1988 Barnwell  
 4,782,670 A 11/1988 Long et al.  
 4,798,063 A 1/1989 Rimmer  
 4,870,837 A 10/1989 Weins  
 4,882,914 A \* 11/1989 Haines-Keeley .. B65D 81/3883  
 62/457.4  
 4,966,303 A 10/1990 Jones  
 4,974,741 A 12/1990 Gustafson et al.  
 5,022,235 A \* 6/1991 Grissom ..... B65D 81/3886  
 62/372  
 5,022,549 A 6/1991 Beaver  
 5,261,554 A 11/1993 Forbes  
 5,467,891 A 11/1995 Perry  
 5,740,951 A 4/1998 Jack  
 D442,833 S \* 5/2001 Shuman ..... D7/608  
 D651,050 S \* 12/2011 Goshi ..... D7/608  
 D675,066 S \* 1/2013 Conlin ..... D7/608  
 D675,881 S \* 2/2013 Wamack, Jr. .... D7/608  
 D727,688 S \* 4/2015 Hewitt ..... D7/624.2  
 D752,397 S \* 3/2016 Seiders ..... D7/624.2  
 D779,892 S \* 2/2017 Seiders ..... D7/624.2  
 D780,531 S \* 3/2017 Seiders ..... D7/624.2  
 D780,533 S \* 3/2017 Seiders ..... D7/624.2

D801,753 S \* 11/2017 Piper ..... D7/624.2  
 10,030,903 B2 7/2018 Nguyen  
 D826,003 S \* 8/2018 Seiders ..... D7/624.2  
 D839,677 S \* 2/2019 Seiders ..... D7/523  
 D845,718 S \* 4/2019 Vargo ..... B65D 81/3886  
 D7/608  
 10,427,858 B2 10/2019 Mackintosh et al.  
 D873,091 S \* 1/2020 Jacobsen ..... B65D 81/3883  
 D7/608  
 D878,160 S \* 3/2020 Corbet ..... D7/523  
 D884,425 S \* 5/2020 Burns ..... D7/510  
 D888,505 S \* 6/2020 Seiders ..... D7/624.2  
 D889,912 S \* 7/2020 Laukala ..... D7/608  
 D889,973 S \* 7/2020 Burns ..... D9/549  
 D891,869 S \* 8/2020 Burns ..... D7/523  
 D891,870 S \* 8/2020 Burns ..... D7/523  
 D891,873 S \* 8/2020 Burns ..... D7/603  
 D891,874 S \* 8/2020 Burns ..... D7/603  
 D901,988 S \* 11/2020 Jacobsen ..... D7/608  
 D902,665 S \* 11/2020 Jacobsen ..... D7/608  
 D908,444 S \* 1/2021 Pape ..... D7/608  
 D920,746 S \* 6/2021 Seiders ..... D7/624.2  
 D926,580 S \* 8/2021 Burns ..... D9/504  
 2014/0250918 A1 9/2014 Lofy  
 2014/0319158 A1 10/2014 Lonsway  
 2015/0191293 A1 7/2015 Forcella  
 2018/0242765 A1 8/2018 Rane et al.  
 2018/0310766 A1 11/2018 Lapsker  
 2018/0312322 A1 11/2018 Canales Kell  
 2018/0335247 A1 11/2018 Huisman  
 2019/0263564 A1 8/2019 Robertaccio

\* cited by examiner

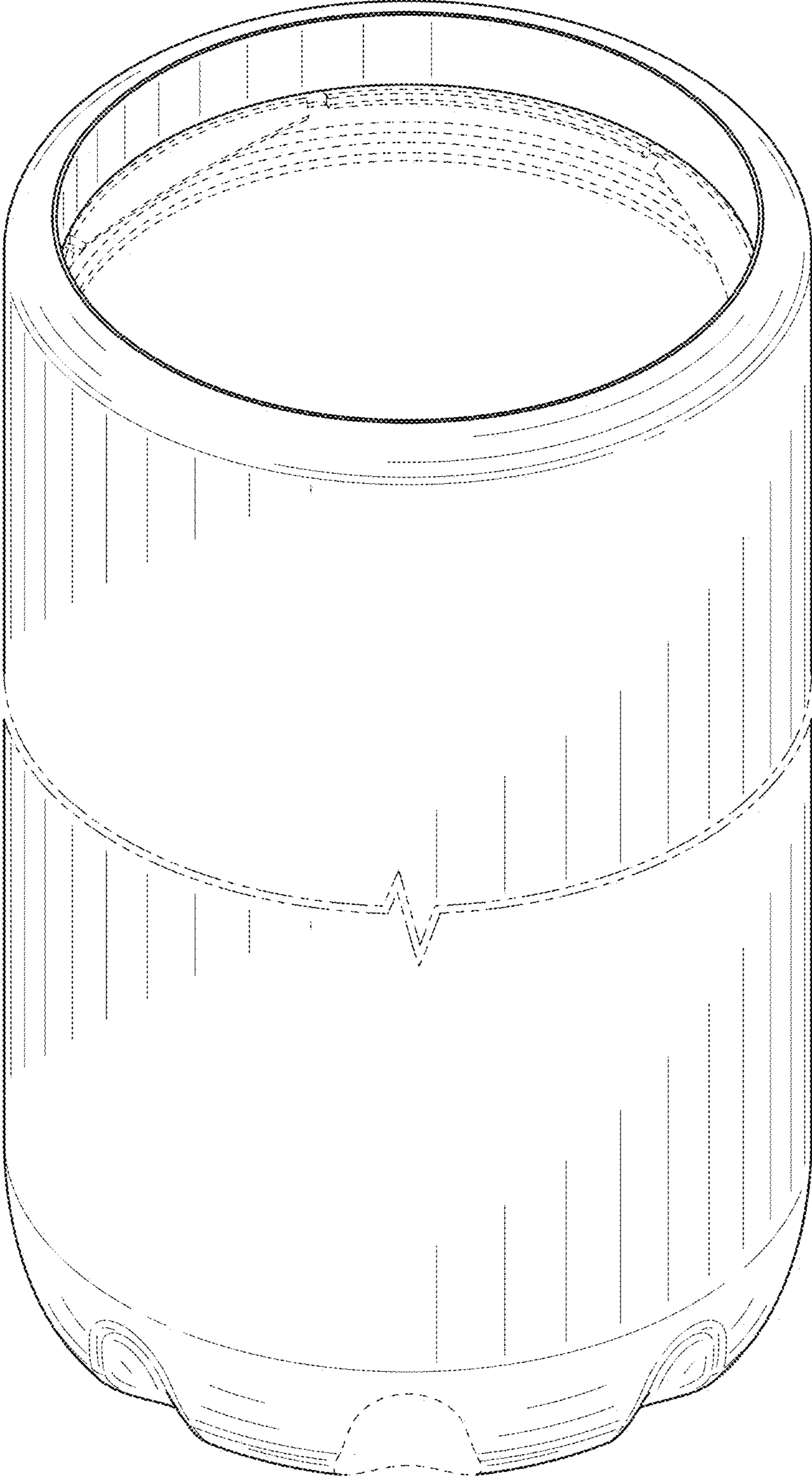

FIG. 1

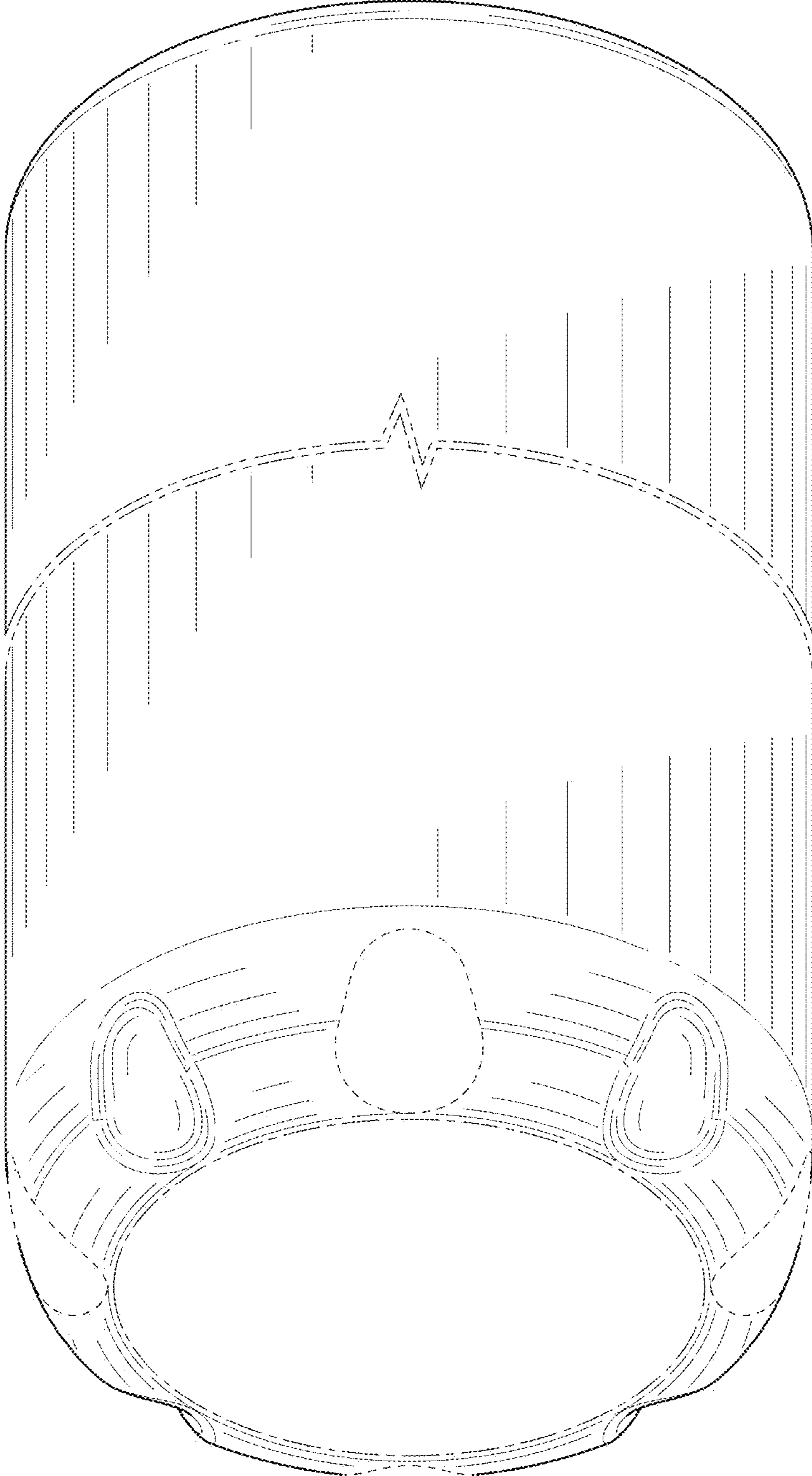

FIG. 2

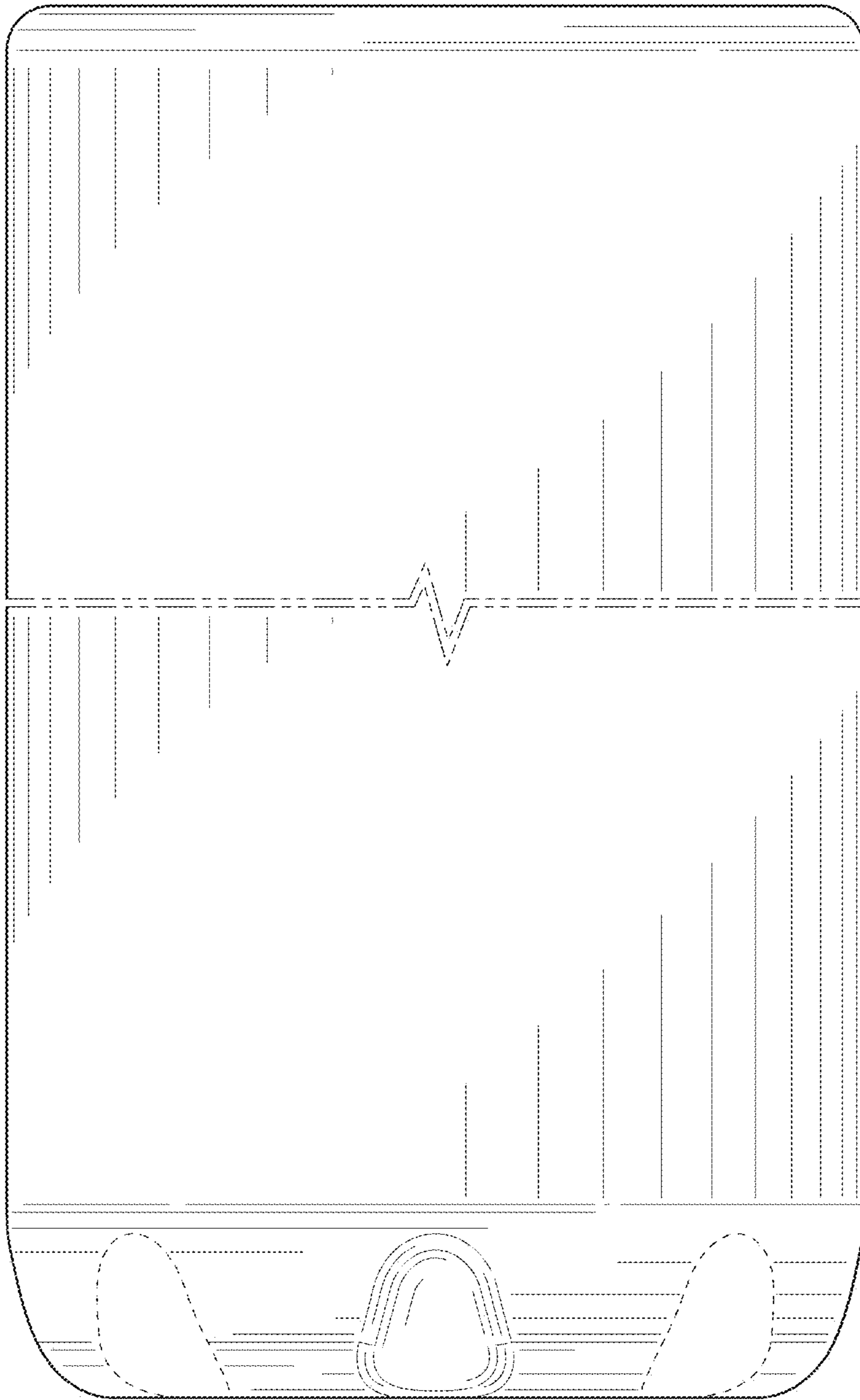

FIG. 3

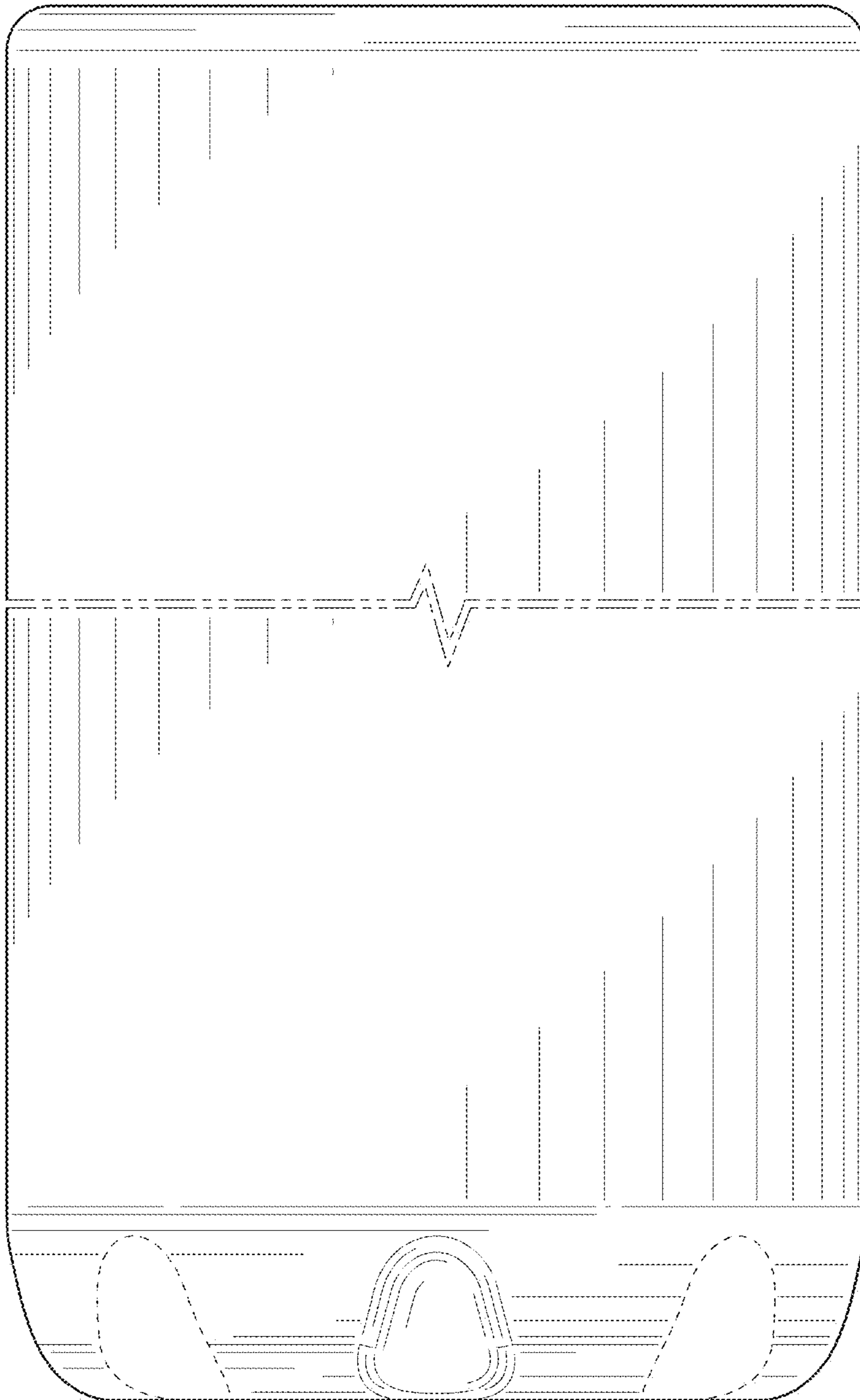

FIG. 4

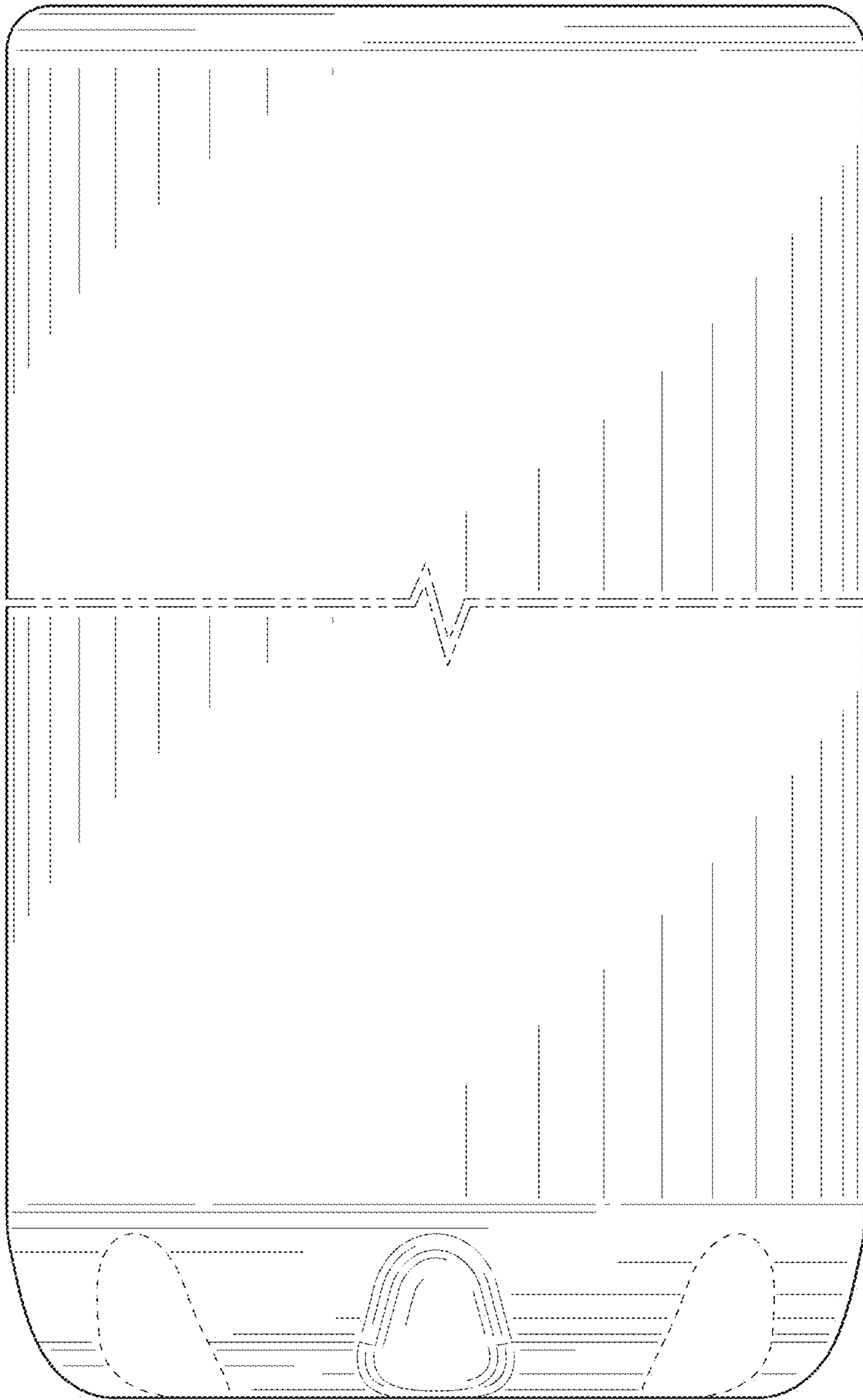

FIG. 5

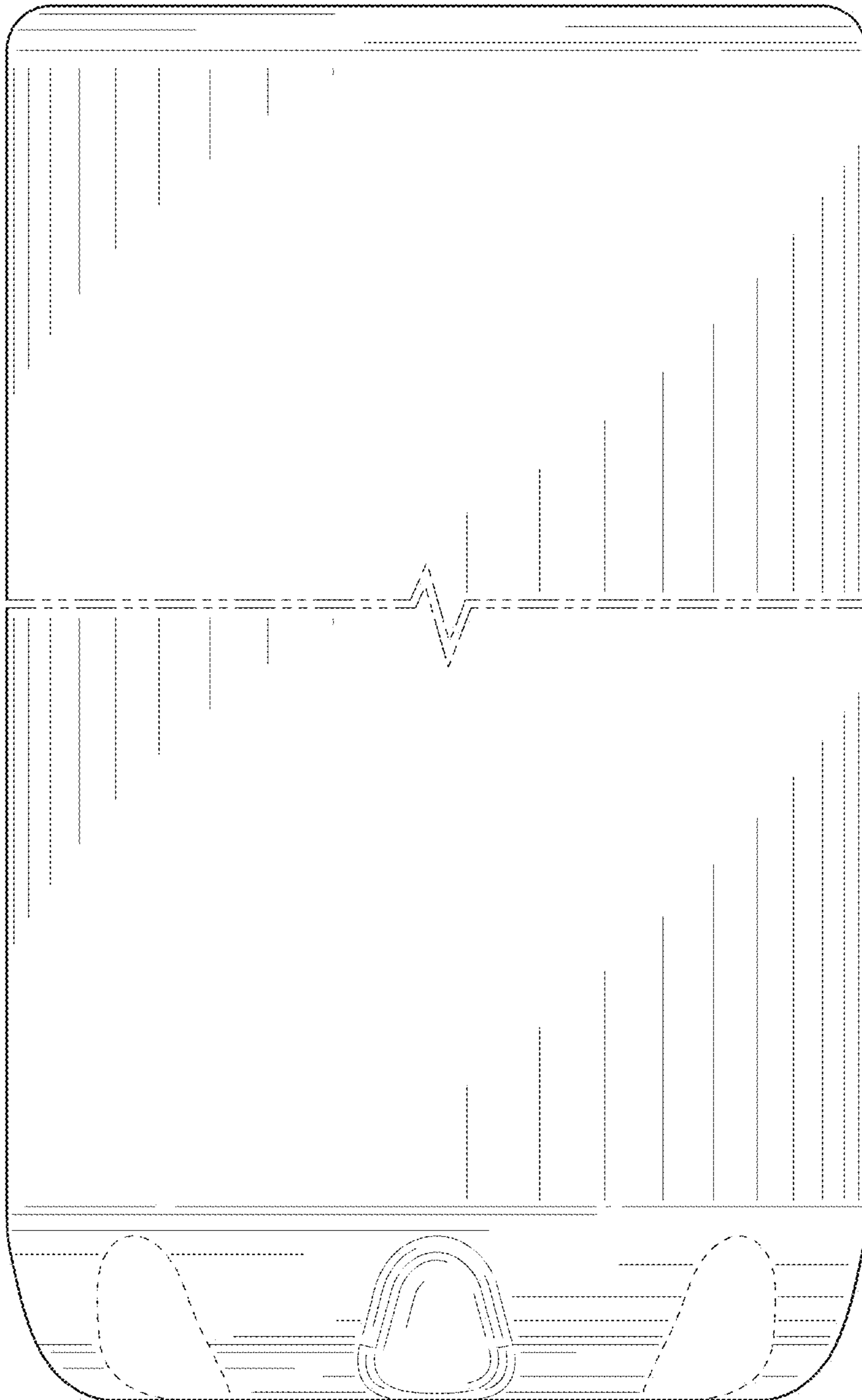

FIG. 6



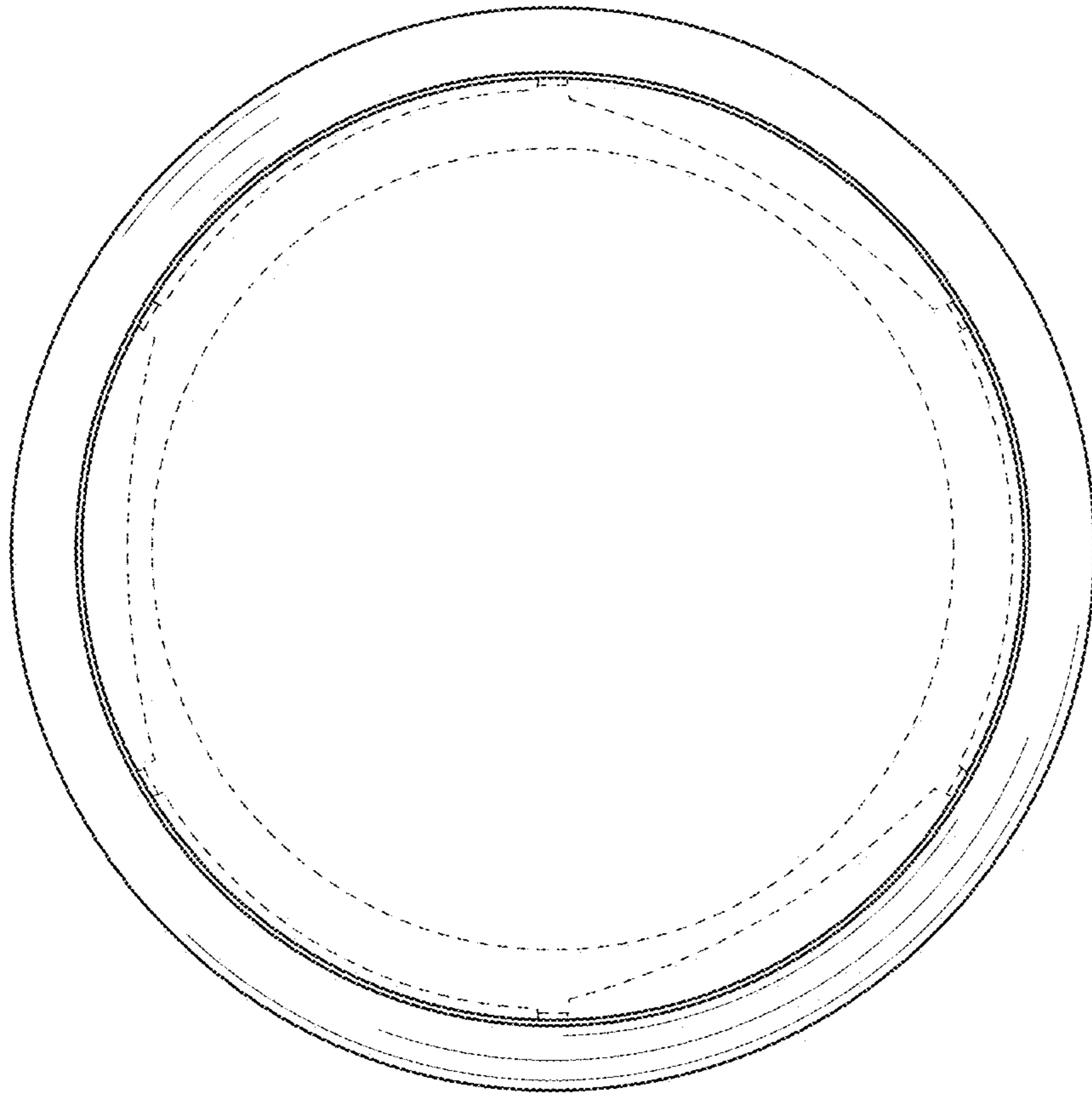

FIG. 7

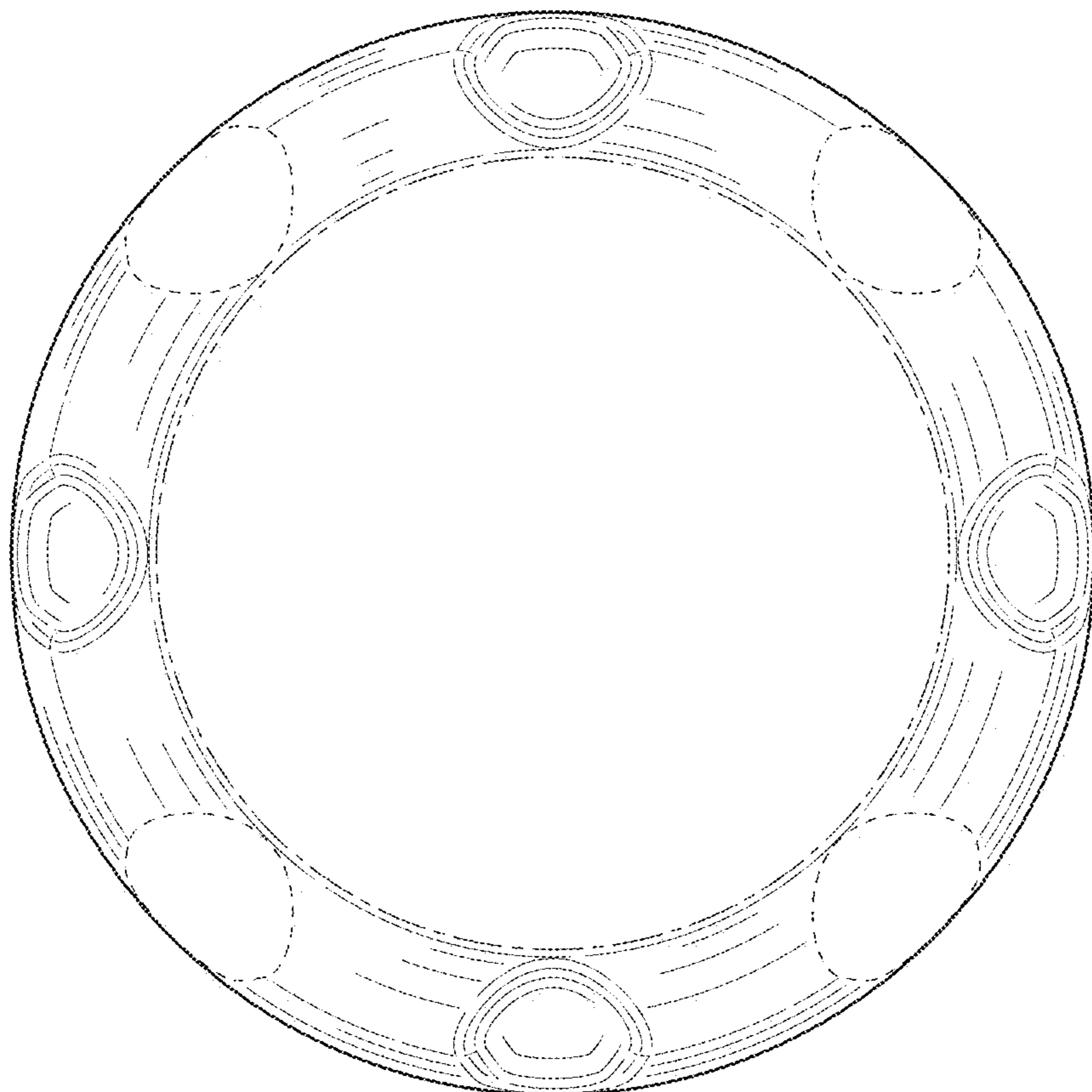

FIG. 8