



US00D951026S

(12) **United States Design Patent** (10) **Patent No.:** **US D951,026 S**  
**Prendes** (45) **Date of Patent:** **\*\* May 10, 2022**

(54) **DRINKING CUP WITH DOME CHAMBER**

FOREIGN PATENT DOCUMENTS

(71) Applicant: **Joaquin Prendes**, Plantation, FL (US)

CN 305185735 \* 5/2019  
CN 307116112 \* 2/2022

(72) Inventor: **Joaquin Prendes**, Plantation, FL (US)

(Continued)

(\*\*) Term: **15 Years**

OTHER PUBLICATIONS

(21) Appl. No.: **29/702,864**

Clear Lake Enterprises, "Polar ICE Pitcher with Aluminum Polar ICE Chamber," Oct. 11, 2010, Amazon.com, www.amazon.com/Polar-Pitcher-Aluminum-Chamber-Ice/dp/B006QYKPOU?th=1 (Year: 2010).\*

(22) Filed: **Aug. 22, 2019**

(Continued)

(51) **LOC (13) Cl.** ..... **07-01**

(52) **U.S. Cl.**

USPC ..... **D7/523**

(58) **Field of Classification Search**

USPC ..... D7/300, 305, 392.1, 396.2, 500, 507,  
D7/509-511, 513, 523, 533, 536, 538,  
D7/619.1, 622, 701-703, 707, 900;  
D9/549, 715, 716, 719, 737, 738, 740,  
D9/743

CPC ..... A47G 19/22; A47G 19/2205; A47G  
19/2227; A47G 19/2272; A47G 19/2288;  
A47G 19/23; A47J 31/407; A47J 31/41;  
A47J 41/0022

See application file for complete search history.

*Primary Examiner* — Shannon W Morgan

*Assistant Examiner* — Arva P Adams

(74) *Attorney, Agent, or Firm* — Albert Bordas, P.A.

(57)

**CLAIM**

The ornamental design for a drinking cup with dome chamber, as shown and described.

**DESCRIPTION**

FIG. 1 is a top plan view of a drinking cup with dome chamber;

FIG. 2 is a front elevational view thereof, rear elevational view being a mirror image thereof;

FIG. 3 is a bottom plan view thereof;

FIG. 4 is a right-side elevational view thereof, left-side elevational view being a mirror image thereof;

FIG. 5 is a cross-section view thereof, taken along line 5-5 from FIG. 2, showing the shape of the dome chamber and its bottom cover;

FIG. 6 is a bottom isometric view thereof, showing the dome chamber assembled;

FIG. 7 is a top isometric view thereof, showing the dome chamber unassembled; and,

FIG. 8 is a bottom isometric view thereof, showing the dome chamber unassembled.

(56)

**References Cited**

U.S. PATENT DOCUMENTS

- 1,561,730 A \* 11/1925 Kodama ..... A47G 19/2227  
359/809
- 4,485,636 A \* 12/1984 Hilado ..... F25D 3/08  
62/457.3
- D308,456 S \* 6/1990 Kalamaras ..... D7/515
- 5,653,124 A \* 8/1997 Weber ..... B65D 81/3886  
62/530
- 5,996,781 A \* 12/1999 Glaser ..... A47G 19/2227  
206/217
- 6,105,814 A \* 8/2000 Chen ..... A47G 19/2227  
206/217
- 6,502,418 B2 \* 1/2003 Holley, Jr. .... A47G 19/2288  
62/530

(Continued)

**1 Claim, 6 Drawing Sheets**

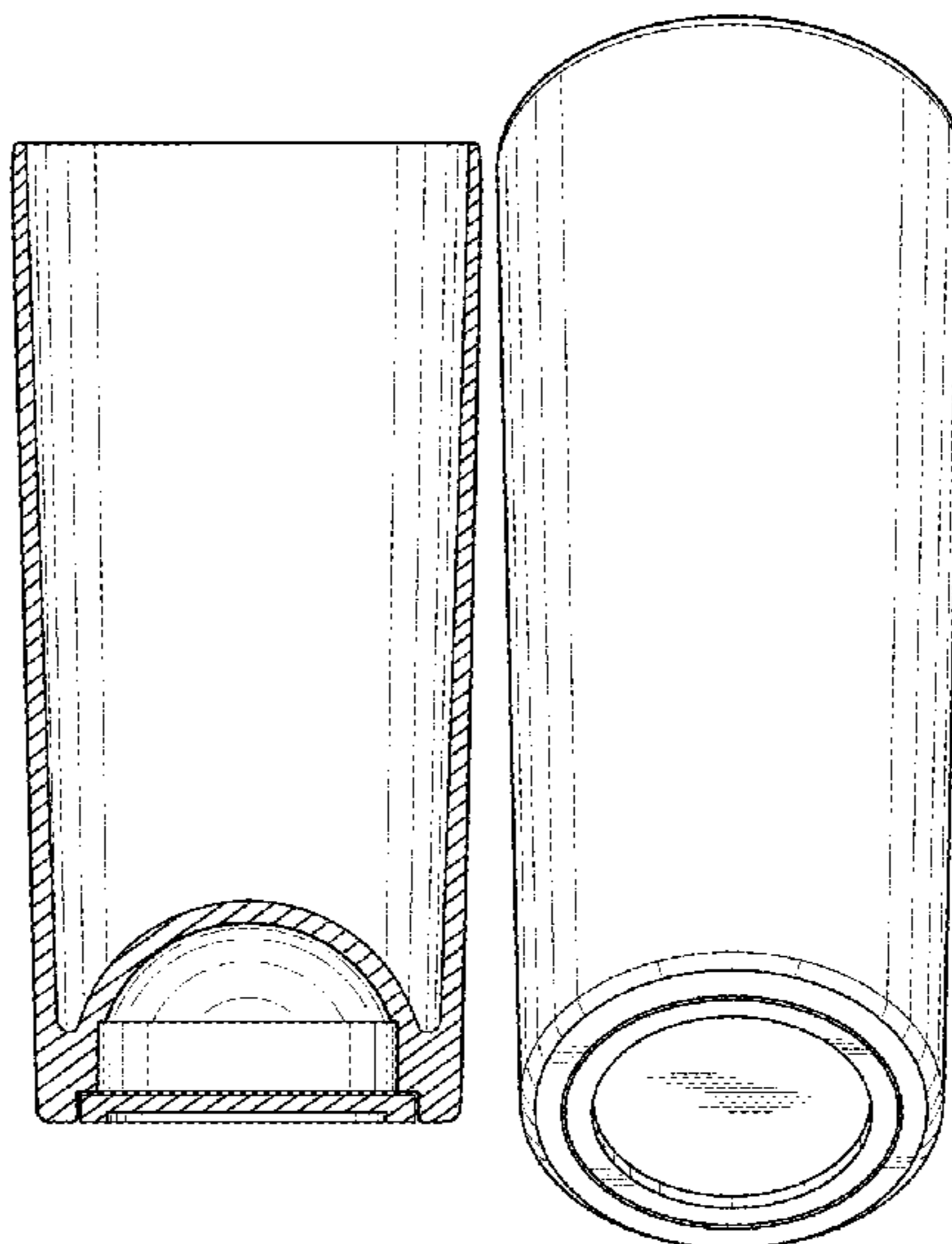

(56)

References Cited

U.S. PATENT DOCUMENTS

7,010,935 B2 \* 3/2006 Citrynell ..... A47G 19/2288  
62/530  
D539,091 S \* 3/2007 Mansfield ..... D7/509  
D551,904 S \* 10/2007 Rousso ..... D7/510  
D555,835 S \* 11/2007 Song ..... B65D 1/0276  
D28/91  
D580,228 S \* 11/2008 Hayden ..... D7/509  
D615,400 S \* 5/2010 Usui ..... D9/454  
D620,757 S \* 8/2010 Ahlm ..... D7/509  
D631,294 S \* 1/2011 Ross ..... D7/523  
D649,836 S \* 12/2011 Dooley ..... D7/536  
D686,454 S \* 7/2013 Roth ..... D7/509  
D703,489 S \* 4/2014 Thomas ..... A47G 19/2288  
D7/523  
D737,100 S \* 8/2015 Ross ..... B65D 81/3886  
D7/523  
D764,870 S \* 8/2016 Choi ..... D7/532  
D777,517 S \* 1/2017 Anzalone ..... A47G 19/2227  
D7/509  
D910,378 S \* 2/2021 Stotesbery ..... A47G 19/2227  
D7/532

2010/0264045 A1\* 10/2010 Chen ..... A47G 19/2227  
206/217  
2015/0014331 A1\* 1/2015 Lazorchak ..... A47G 19/2288  
220/574.2  
2019/0133358 A1\* 5/2019 Clyde ..... B65D 1/0276

FOREIGN PATENT DOCUMENTS

JP D1491913 \* 3/2014  
WO WO-9910244 A1 \* 3/1999 ..... A47G 19/2227  
WO WO-2018002921 A1 \* 1/2018 ..... A47G 19/2227

OTHER PUBLICATIONS

Clear Lake Enterprises, "Polar Ice 50 Count Disposable Plastic Power Bomber Shot Cups or Jager Bomb Glasses," Mar. 4, 2011, Amazon.com, [www.amazon.com/Polar-Ice-Disposable-Plastic-Glasses/dp/B004QKVB58?th=1](http://www.amazon.com/Polar-Ice-Disposable-Plastic-Glasses/dp/B004QKVB58?th=1) (Year: 2011).\*

Smuggle Mug, "Smuggle Mug with hidden 12oz flask," Sep. 6, 2013, YouTube, [www.youtube.com/watch?v=sNWkhLP16c](http://www.youtube.com/watch?v=sNWkhLP16c) (Year: 2013).\*

Jtronicsinc, "Covert Coffee Clandestine Concealment Device Concealed by being submerged," Jun. 25, 2013, Ebay, [www.ebay.com/itm/231006630971](http://www.ebay.com/itm/231006630971) (Year: 2013).\*

\* cited by examiner

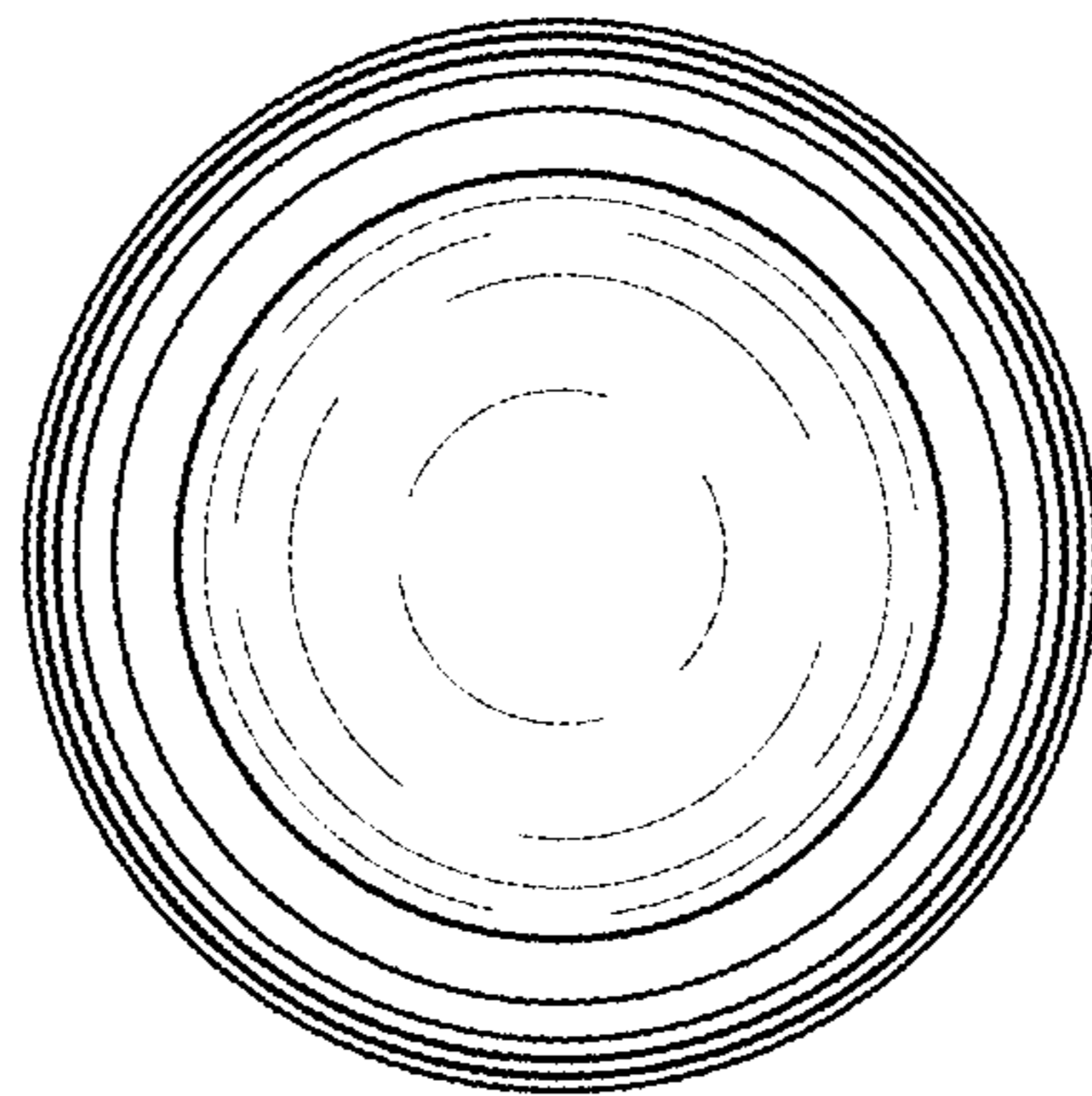

FIG. 1

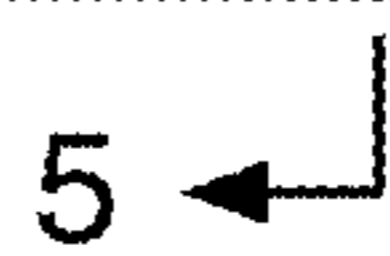
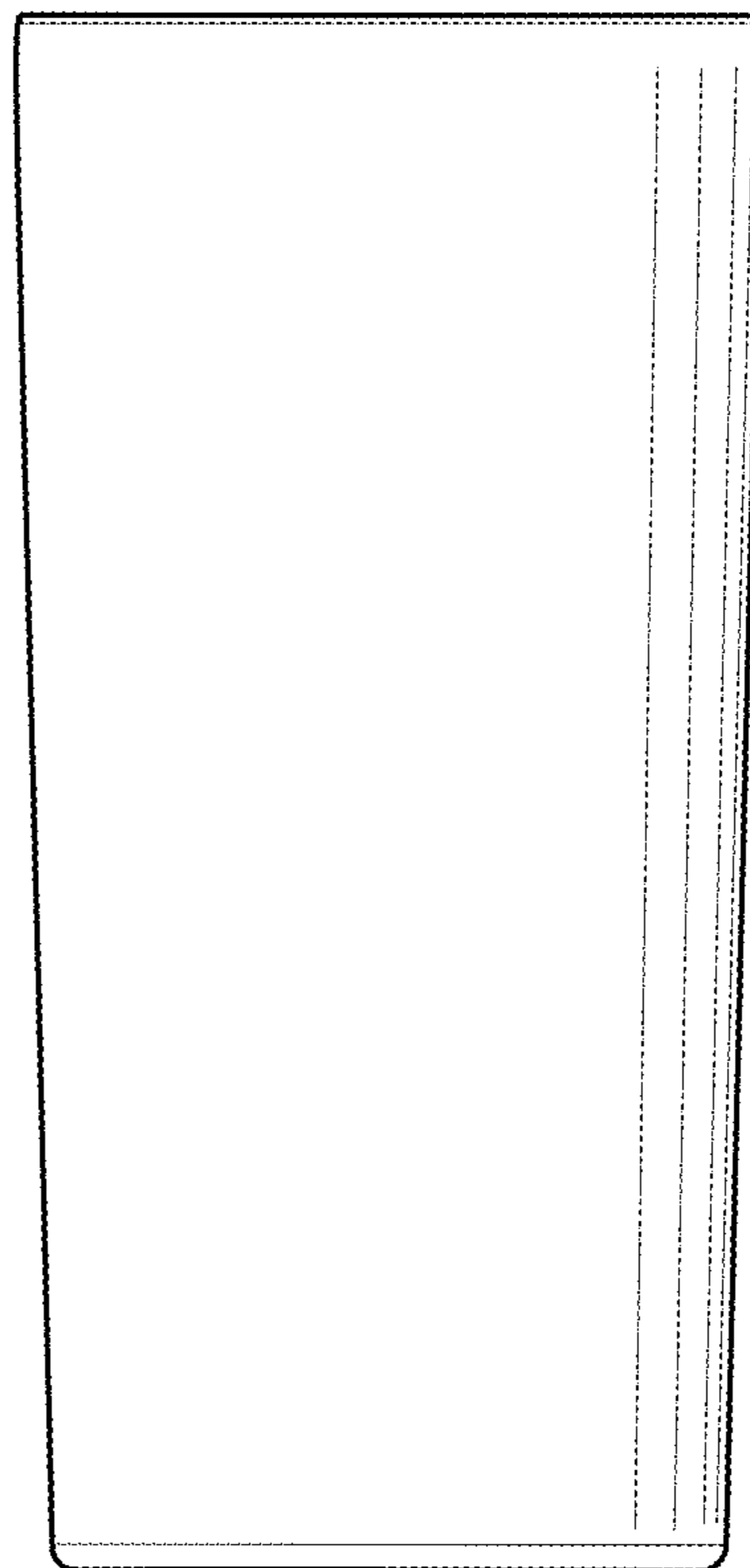
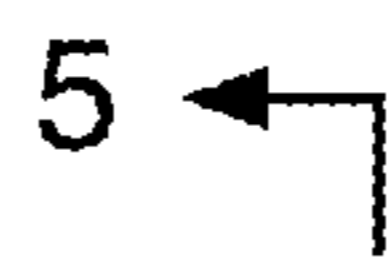

FIG. 2

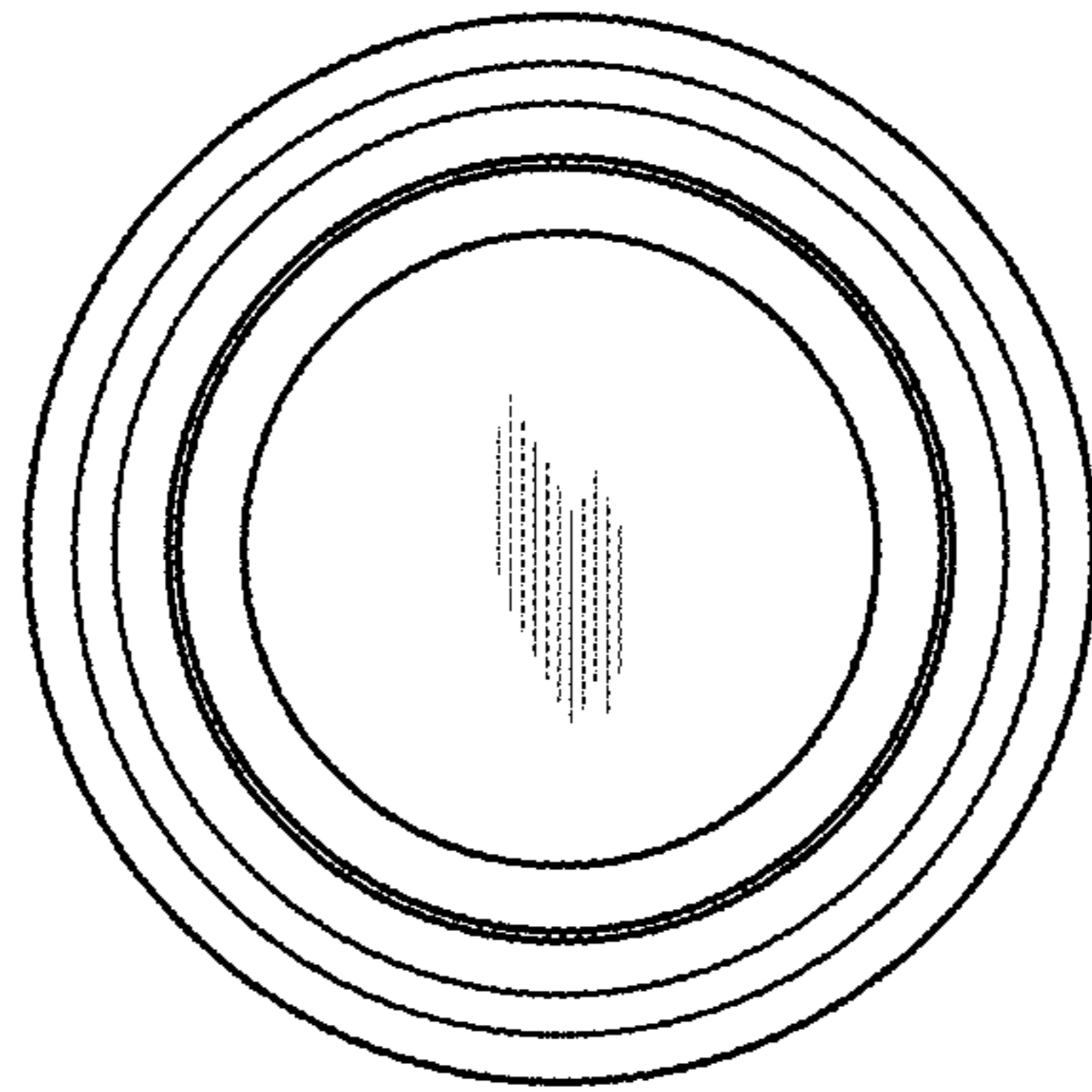

FIG. 3

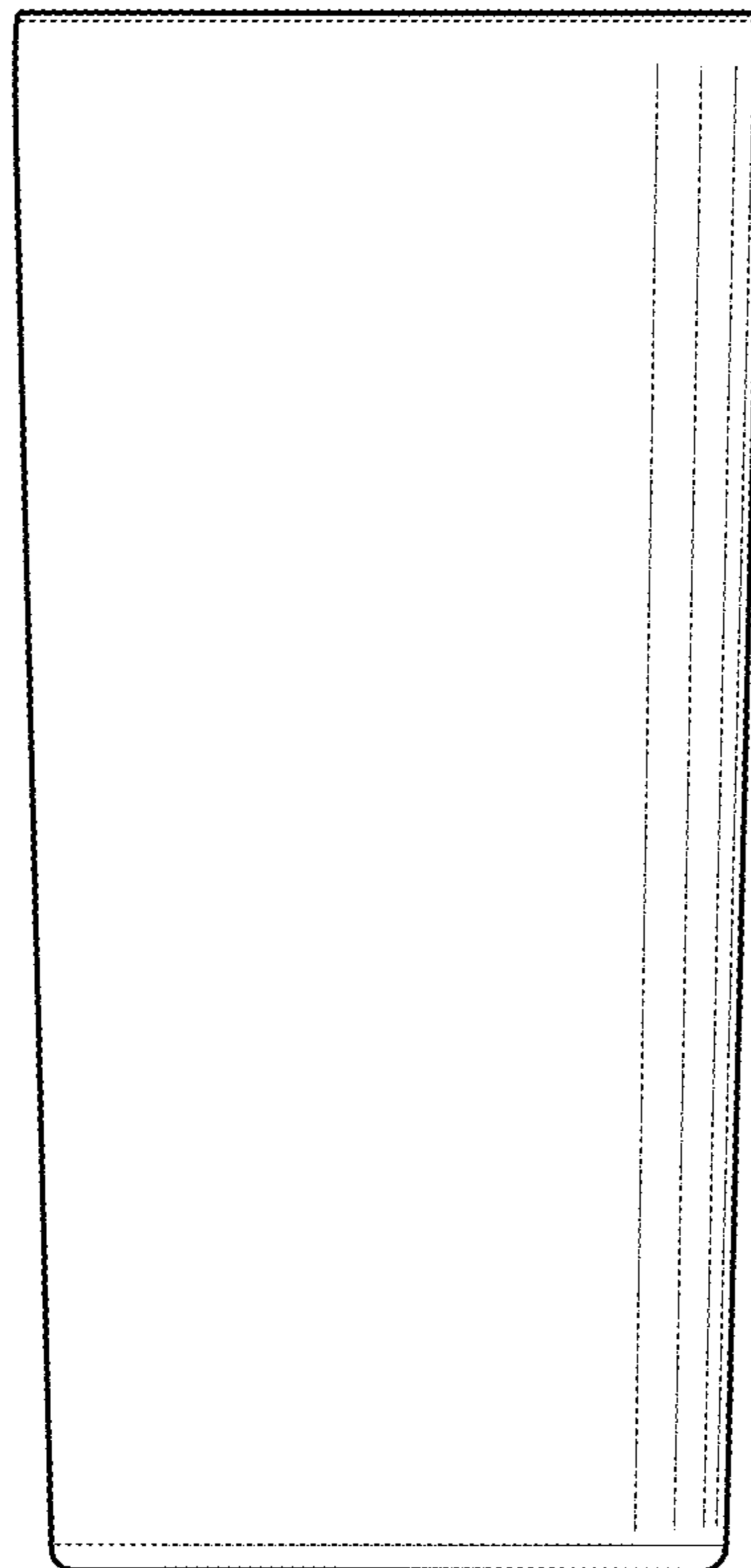

FIG. 4

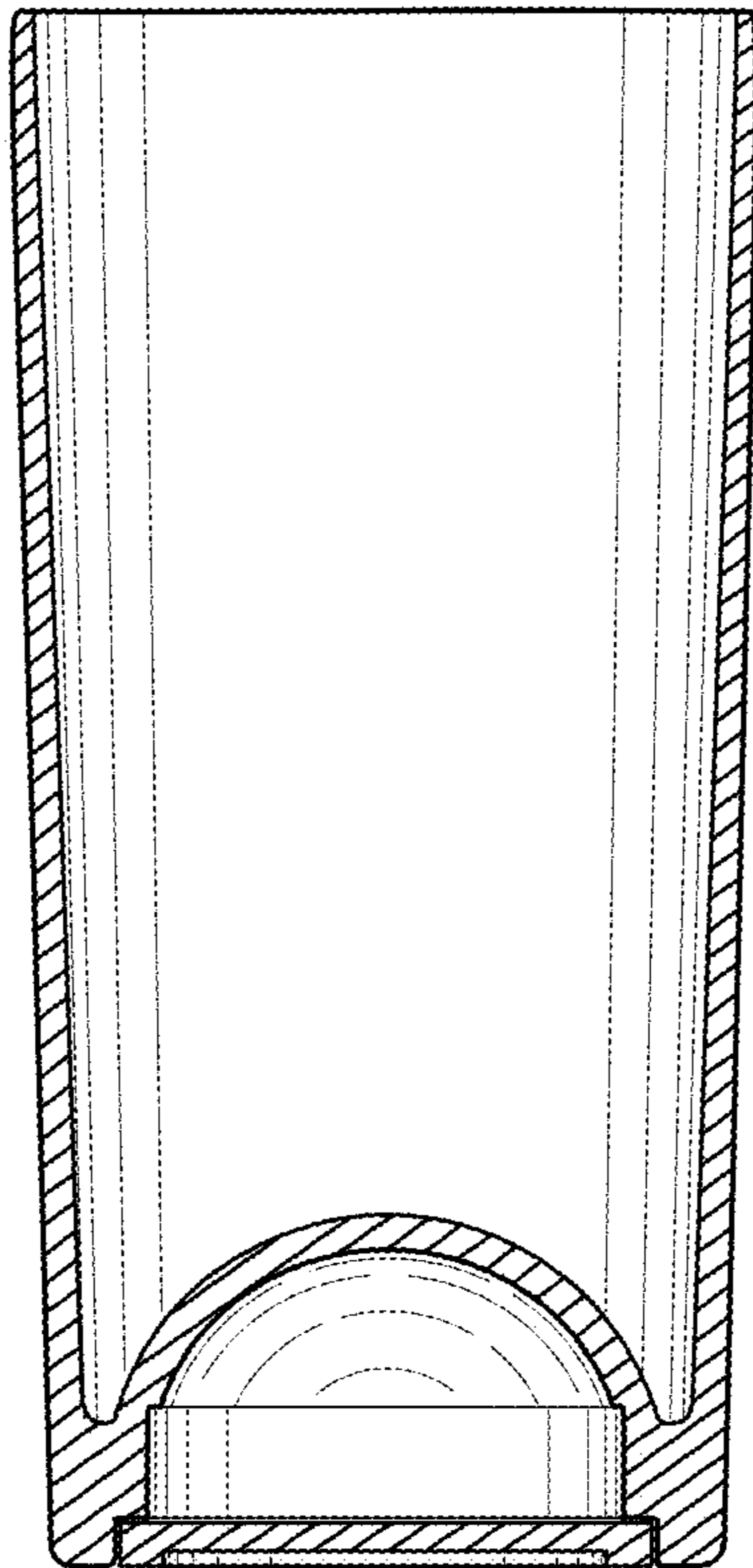

FIG. 5

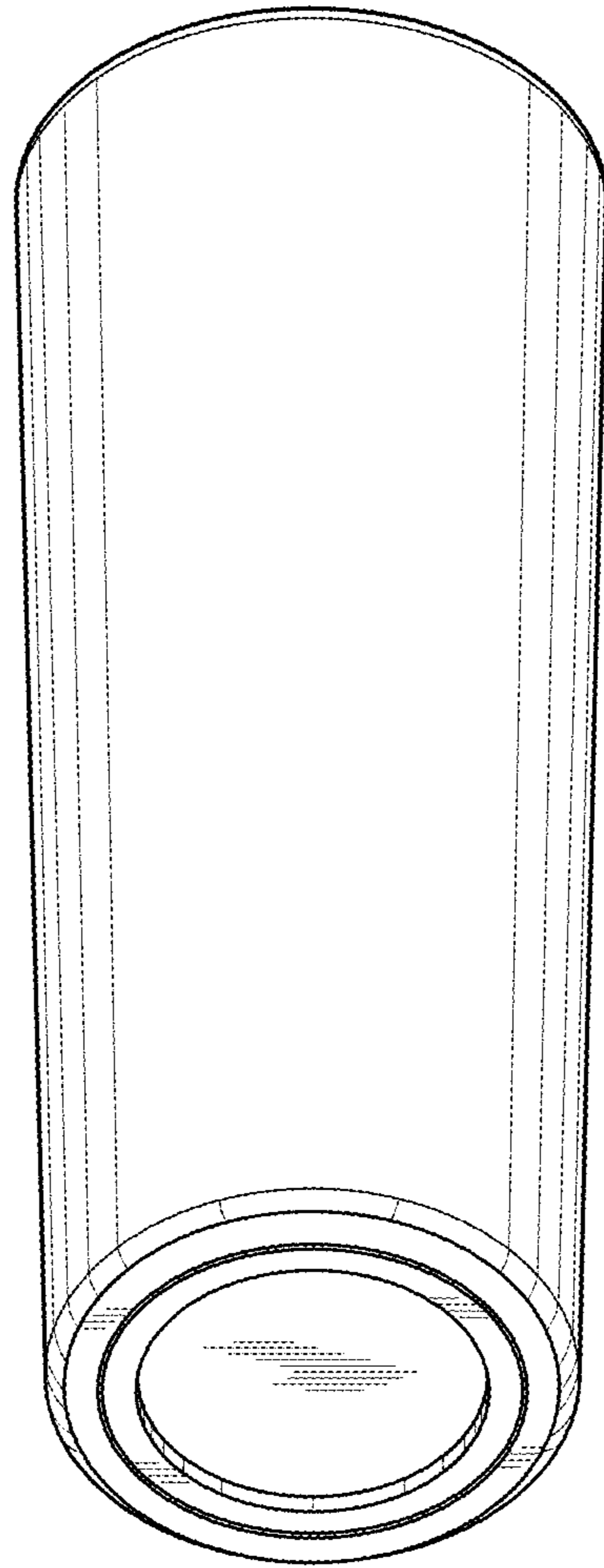

FIG. 6



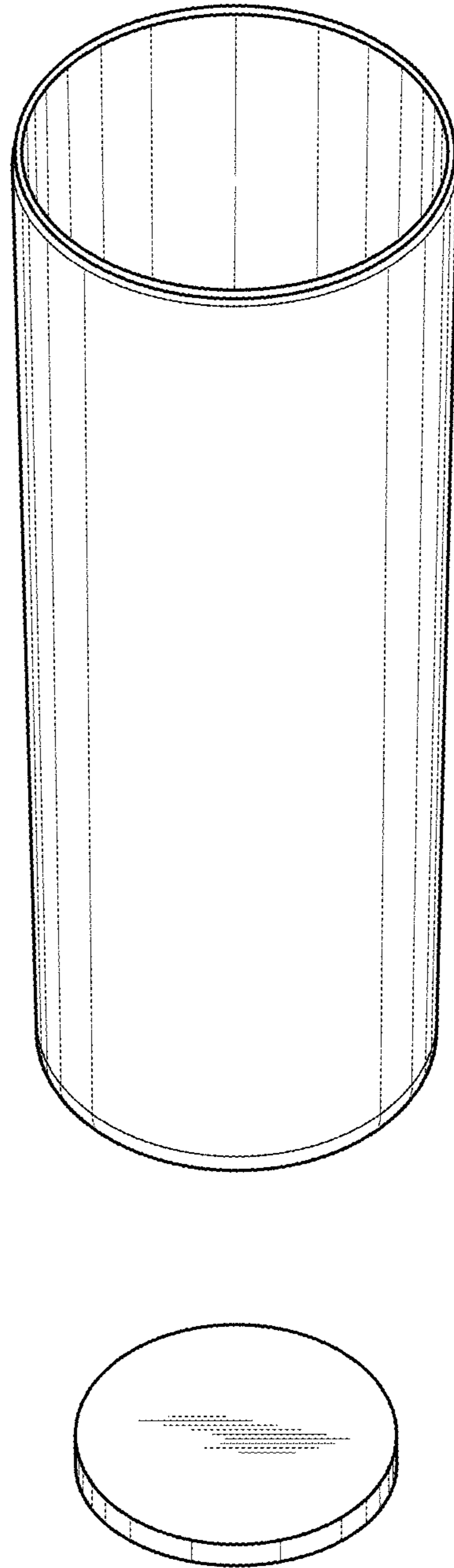

FIG. 7

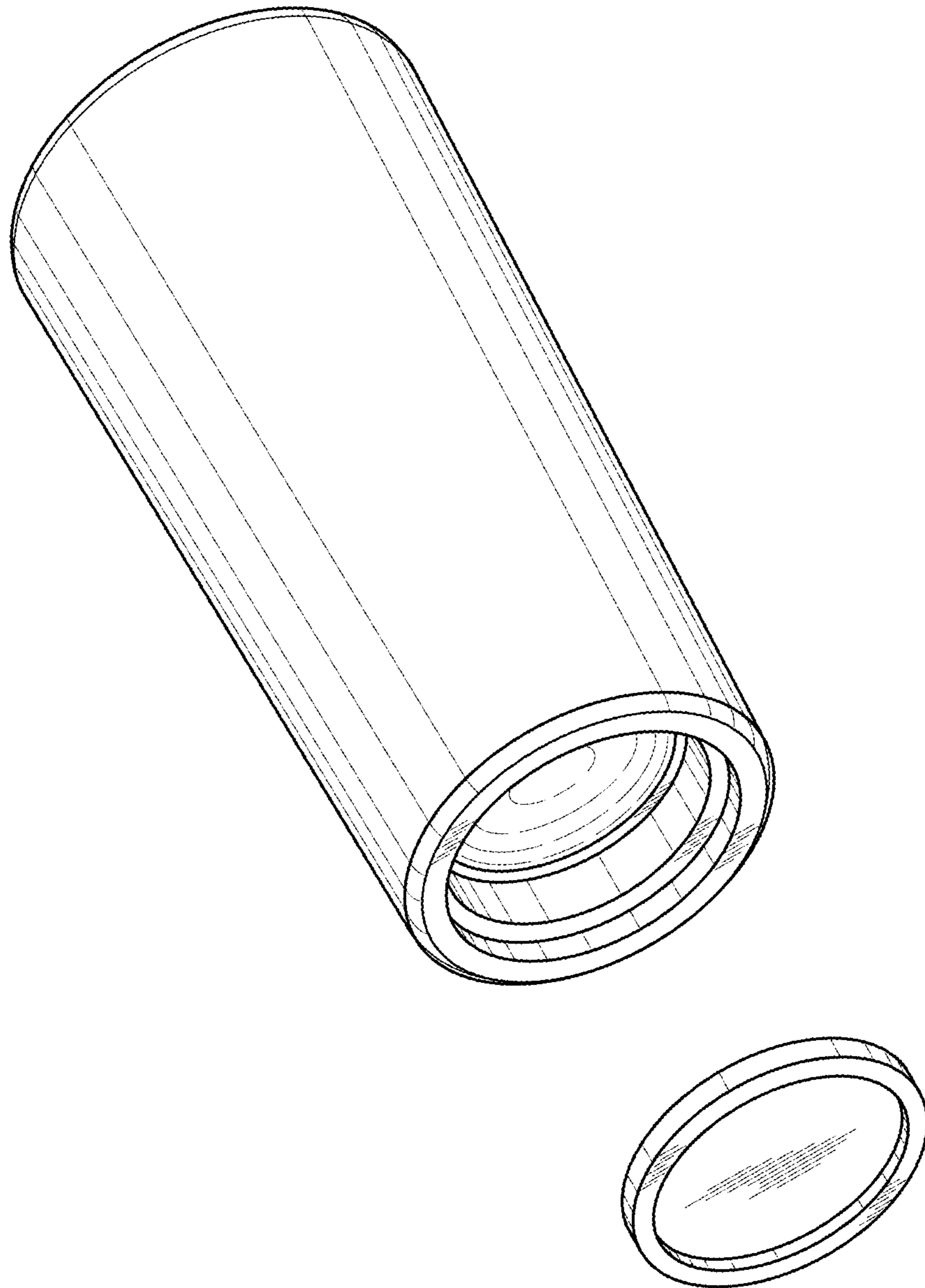

FIG. 8