



US00D951025S

(12) **United States Design Patent**
Zheng et al.

(10) **Patent No.:** **US D951,025 S**

(45) **Date of Patent:** **** May 10, 2022**

(54) **WATER BOTTLE**

(71) Applicant: **SHENZHEN QIANHAI PATUOXUN NETWORK AND TECHNOLOGY CO., LTD.**, Shenzhen (CN)

(72) Inventors: **Xiaojun Zheng**, Shenzhen (CN); **Yan Duan**, Shenzhen (CN)

(73) Assignee: **SHENZHEN QIANHAI PATUOXUN NETWORK AND TECHNOLOGY CO., LTD.**, Shenzhen (CN)

(**) Term: **15 Years**

(21) Appl. No.: **29/776,547**

(22) Filed: **Mar. 31, 2021**

(51) **LOC (13) Cl.** **07-01**

(52) **U.S. Cl.**
USPC **D7/510; D7/536**

(58) **Field of Classification Search**
USPC D7/507, 510, 511, 523, 531, 532, 392.1,
D7/396.2, 536; D9/517, 531; D3/202
CPC A47J 41/0077; A47J 41/02; B65D 47/066;
A47G 19/2288; A47G 19/22
See application file for complete search history.

(56) **References Cited**

U.S. PATENT DOCUMENTS

| | | | |
|--------------|---------|-------|--------|
| D825,914 S | 8/2018 | Dent | |
| D881,647 S * | 4/2020 | Wang | D9/531 |
| D889,114 S | 7/2020 | Huang | |
| D889,910 S * | 7/2020 | Wang | D7/532 |
| D892,557 S * | 8/2020 | Wang | D7/510 |
| D893,262 S * | 8/2020 | Wang | D9/531 |
| D899,192 S * | 10/2020 | Yu | D7/510 |
| D902,648 S * | 11/2020 | Wang | D9/449 |
| D909,815 S * | 2/2021 | Gui | D7/533 |
| D922,826 S * | 6/2021 | Lin | D7/510 |

| | | | |
|-------------------|---------|---------|-----------|
| D928,558 S * | 8/2021 | Han | D7/392.1 |
| D929,802 S * | 9/2021 | Han | D7/392.1 |
| D933,425 S * | 10/2021 | Hao | D7/533 |
| D937,036 S * | 11/2021 | Shi | D7/392.1 |
| D942,808 S * | 2/2022 | Wang | D7/392.1 |
| 2017/0253395 A1 * | 9/2017 | Matthis | A45F 3/16 |

OTHER PUBLICATIONS

Giotto 32oz Motivational Water Bottle with Time Marker & Straw, Leakproof BPA Free Water Jug to Remind You Drink More Water, Hydrate in Style by Guangysg Group https://www.amazon.com/dp/B091YT222X/ref=cm_sw_em_r_mt_dp_P3M46CZ5E3SEXGZ5QDV2 (Year: 2021).*
MEITAGIE 32oz Motivational Water Bottle with Time Marker & Fruit Strainer, Leak-proof BPA Free Non-Toxic 1l Bottle https://www.amazon.com/dp/B0978PH3TN/ref=cm_sw_em_r_mt_dp_7PWJ88SGGN5ZVGX2XYS4?_encoding=UTF8&psc=1 (Year: 2021).*

(Continued)

Primary Examiner — Jae Liang

(57) **CLAIM**

The ornamental design for a water bottle, as shown and described.

DESCRIPTION

FIG. 1 is a perspective view of a water bottle showing my new design;
FIG. 2 is another perspective view thereof;
FIG. 3 is a front elevational view thereof;
FIG. 4 is a rear elevational view thereof;
FIG. 5 is a left side elevational view thereof;
FIG. 6 is a right side elevational view thereof;
FIG. 7 is a top plan view thereof;
FIG. 8 is a bottom plan view thereof; and,
FIG. 9 is an enlarged view of portion 9 shown in FIG. 1.
The broken lines in the drawings depict portions of the water bottle that form no part of the claimed design.

1 Claim, 9 Drawing Sheets

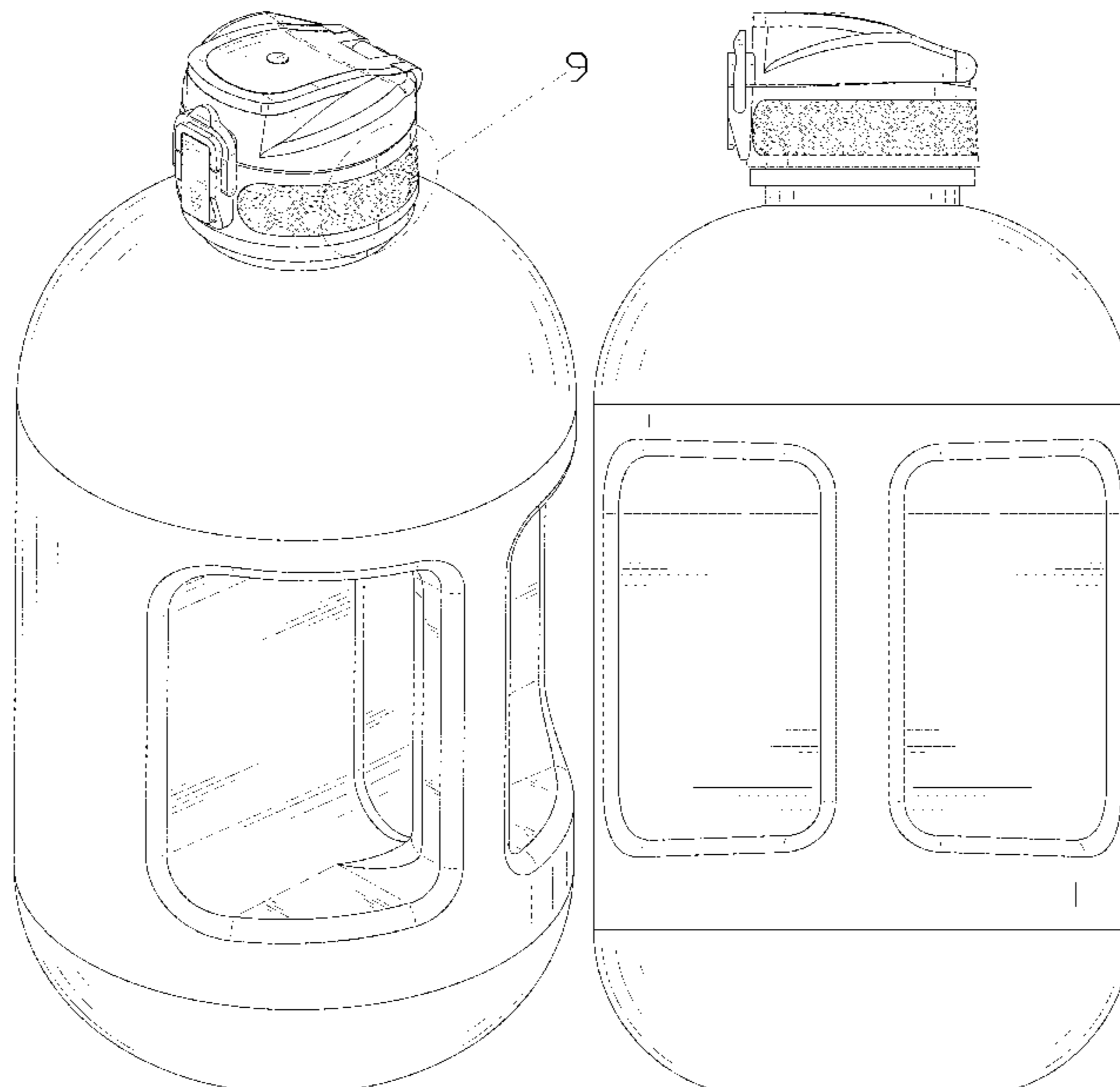

(56)

References Cited

OTHER PUBLICATIONS

Venture Pal Large 1 Gallon/128oz Motivational Water Bottle with Time Marker & Measurements, Leakproof BPA Free Sports Water Bottle to Ensure You Drink https://www.amazon.com/dp/B099WGCGJ2/ref=cm_sw_em_r_mt_dp_

WP8N5EQ6MGWFACWSXPEF?_encoding=UTF8&psc=1 (Year: 2021).*

OTTEN 1 Gallon /128oz Leakproof BPA Free Drinking Water Bottle and Motivational Time Markers&Handle,Ensure Enough Water-Drinking Amount for Fitness https://www.amazon.com/dp/B0949677M4/ref=cm_sw_em_r_mt_dp_

E8X7VP9S8D6BS1G0B60W?_encoding=UTF8&psc=1 (Year: 2021).*

Bottle Bottle Gallon Water Bottle Motivational with Straw&Big Handle, 128oz/1 Gallon Water Bottle Ensure You Drink Enough Water Daily https://www.amazon.com/dp/B08SVYR871/ref=cm_sw_em_r_mt_dp_V6F2F8E1M0VKS0Z2AJE1 (Year: 2021).*

* cited by examiner

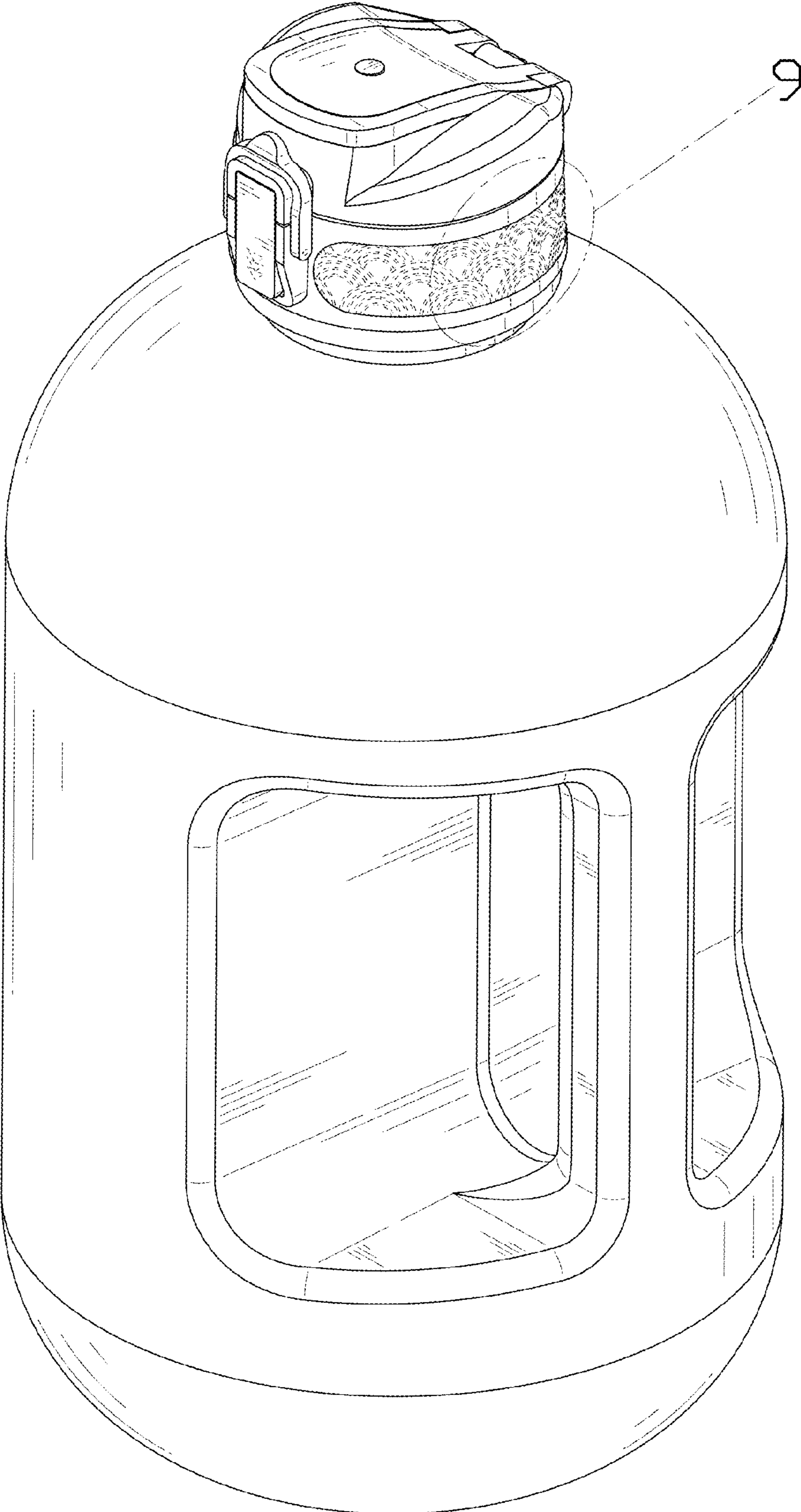

FIG. 1

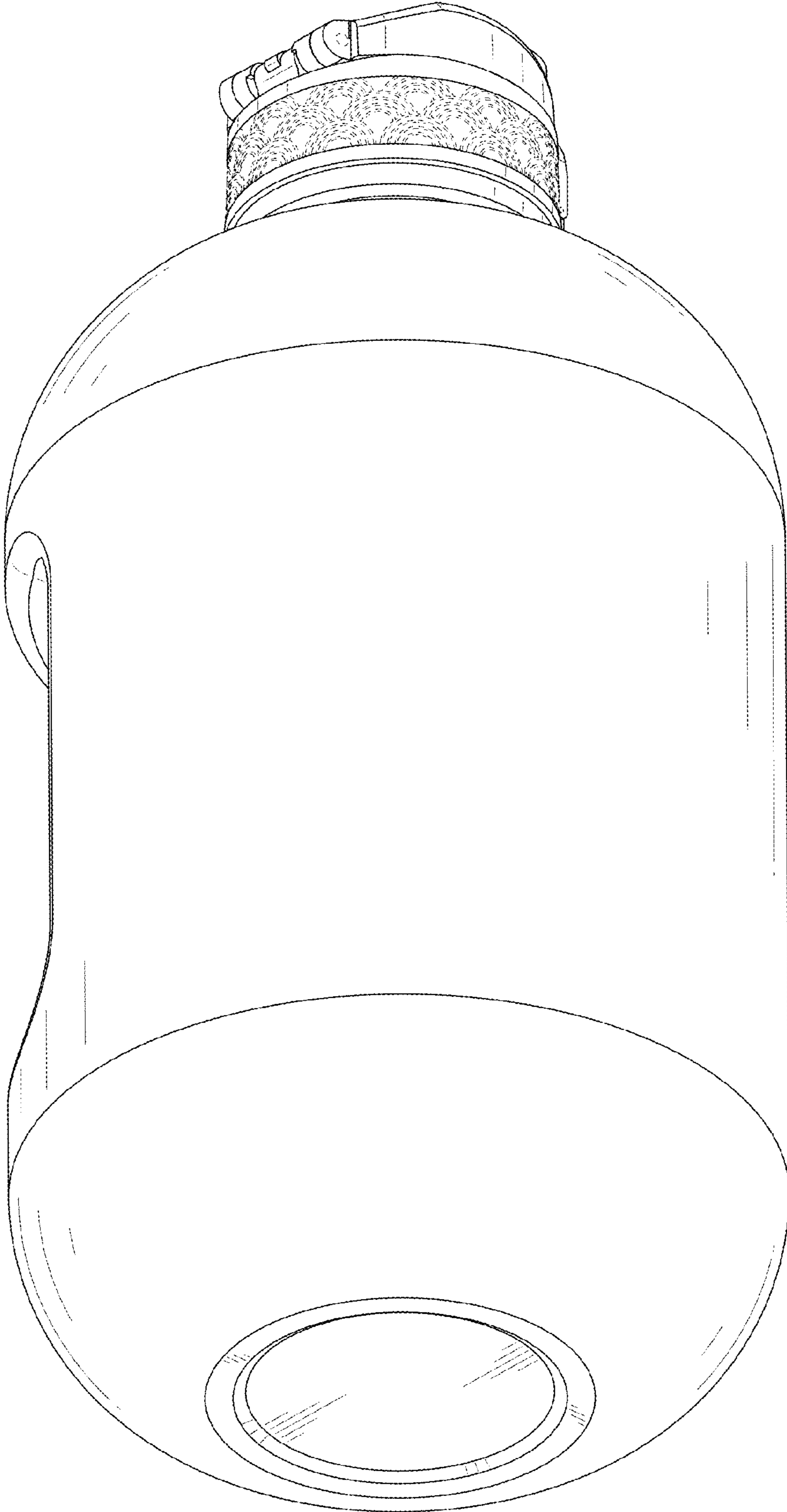

FIG. 2

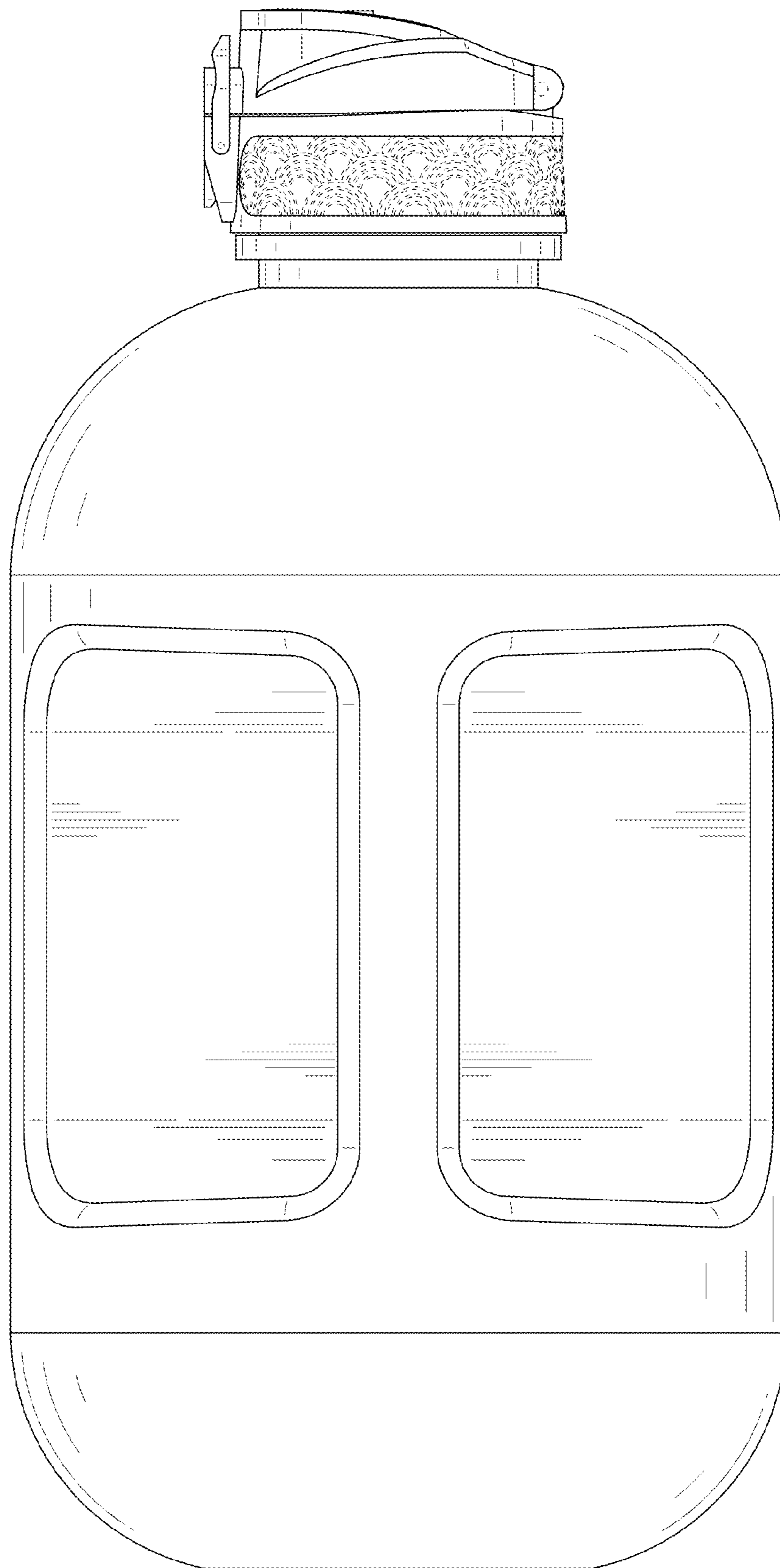

FIG. 3

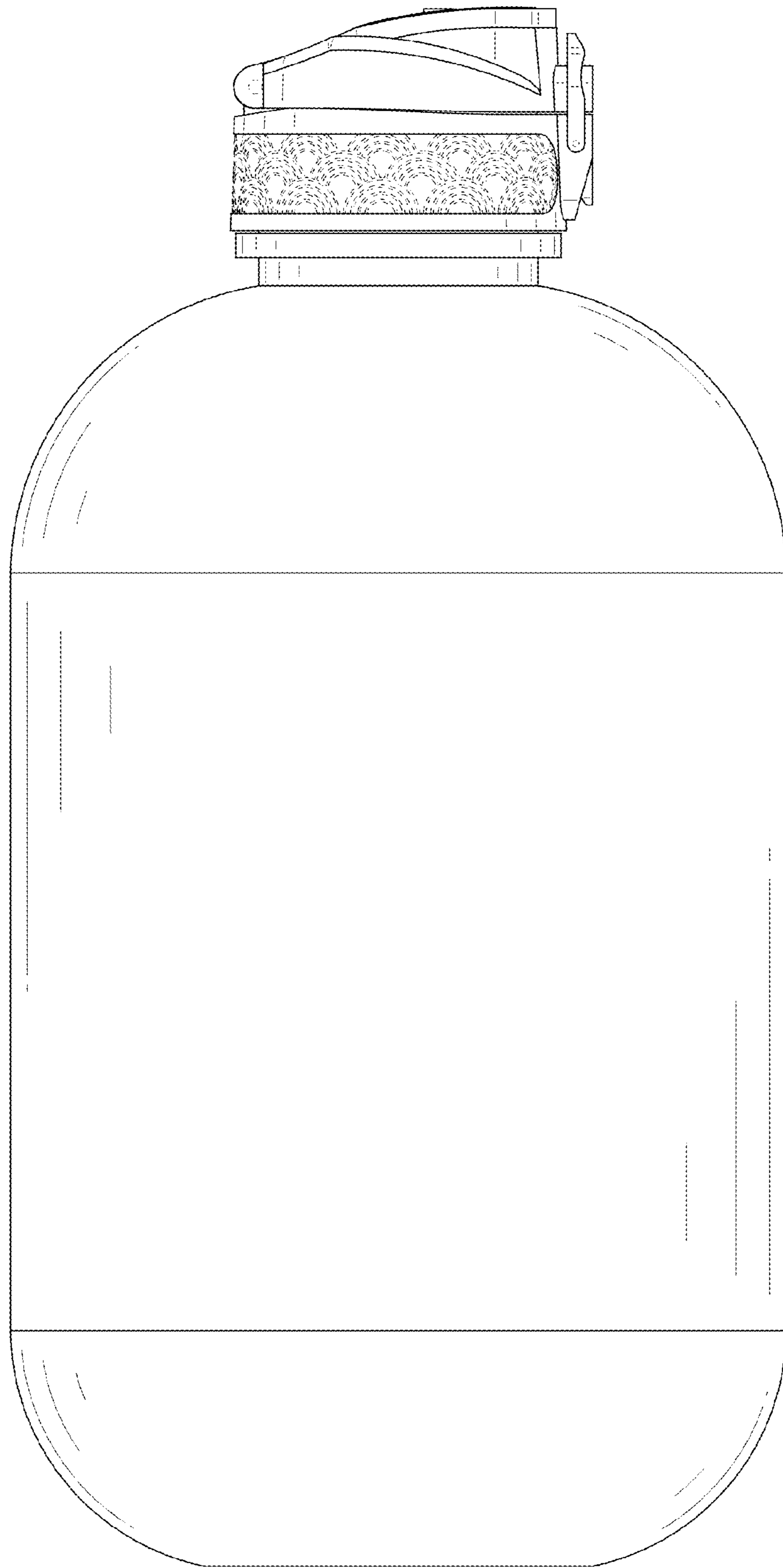

FIG. 4

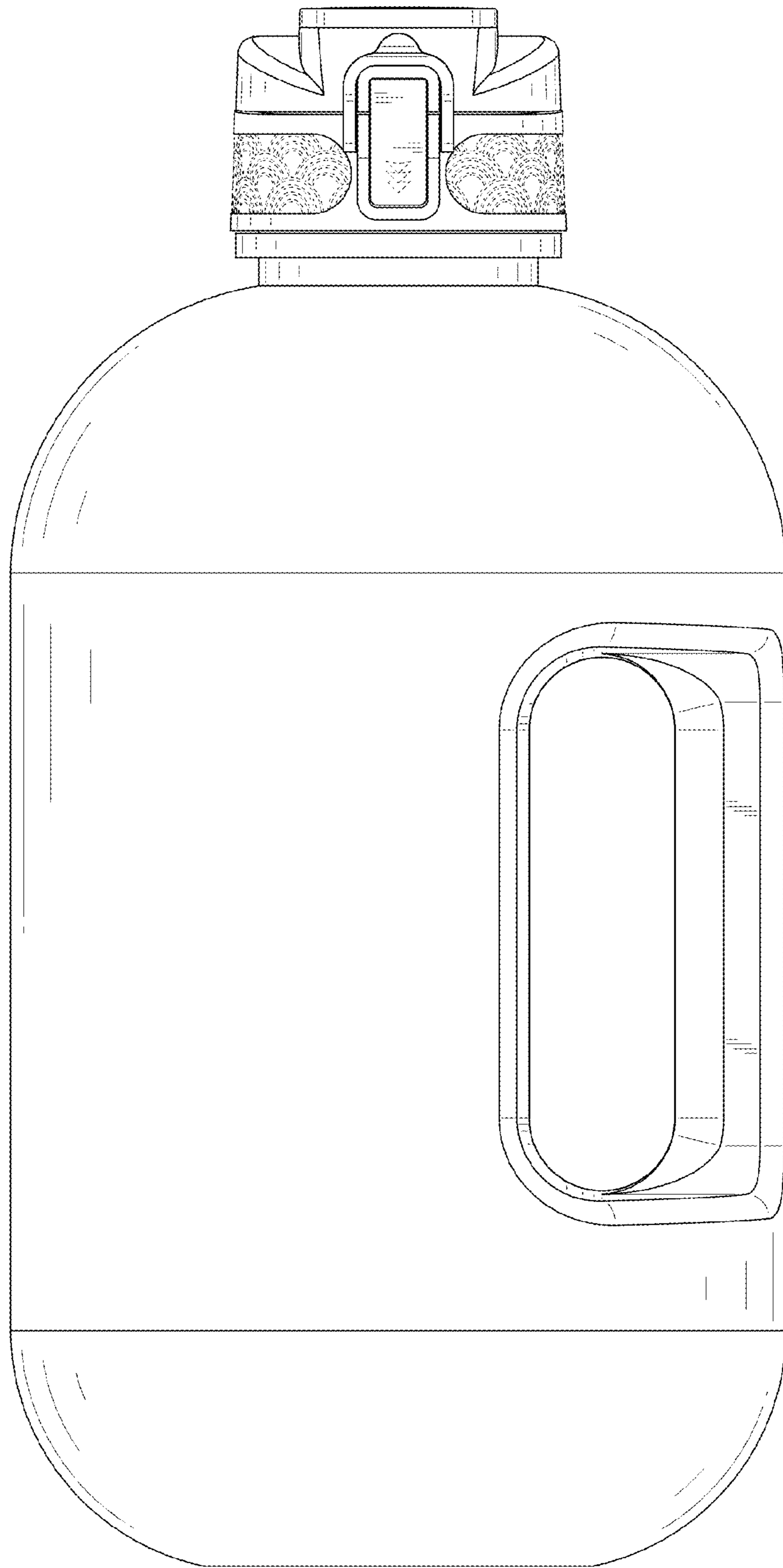

FIG. 5

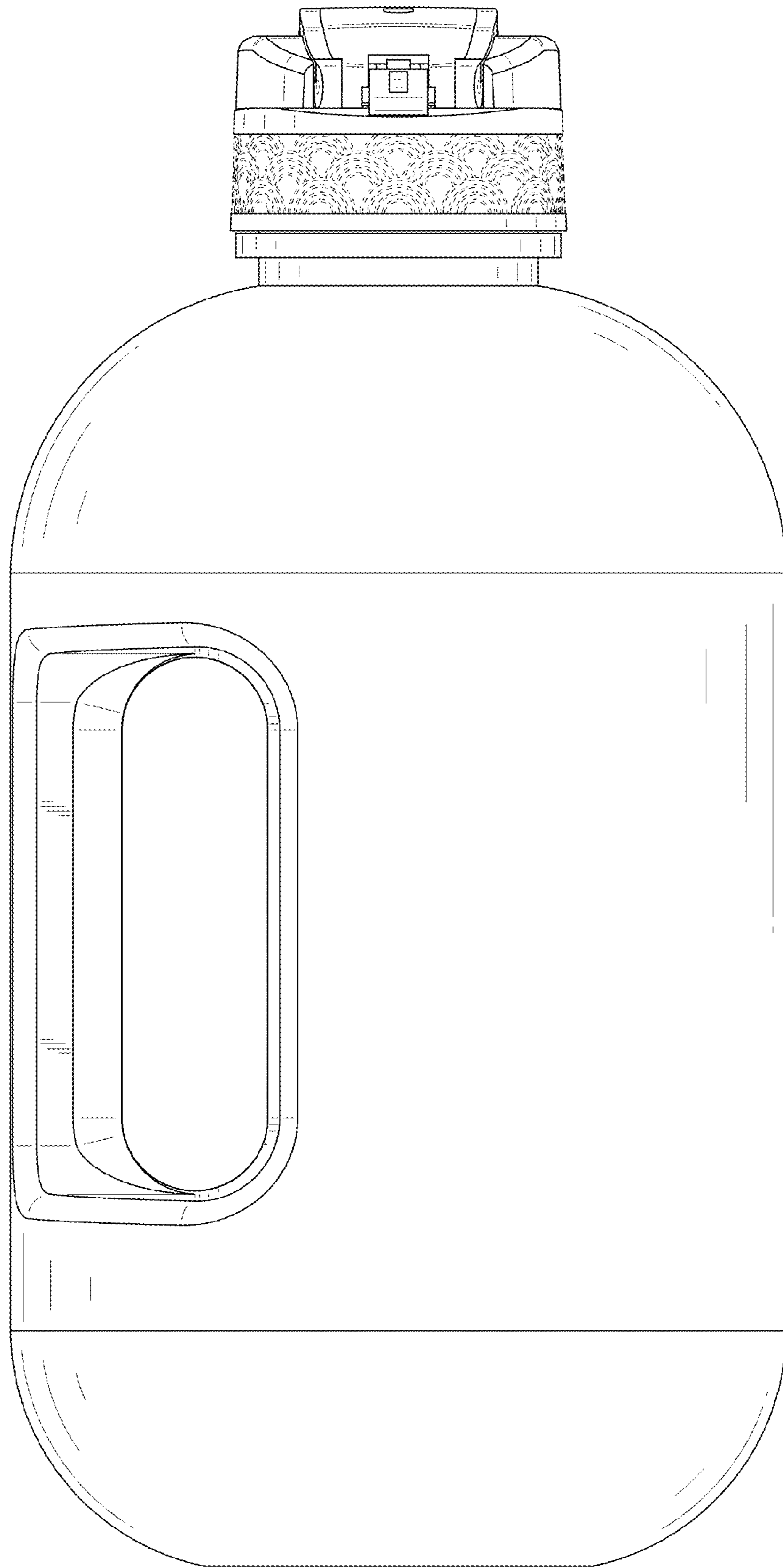

FIG. 6

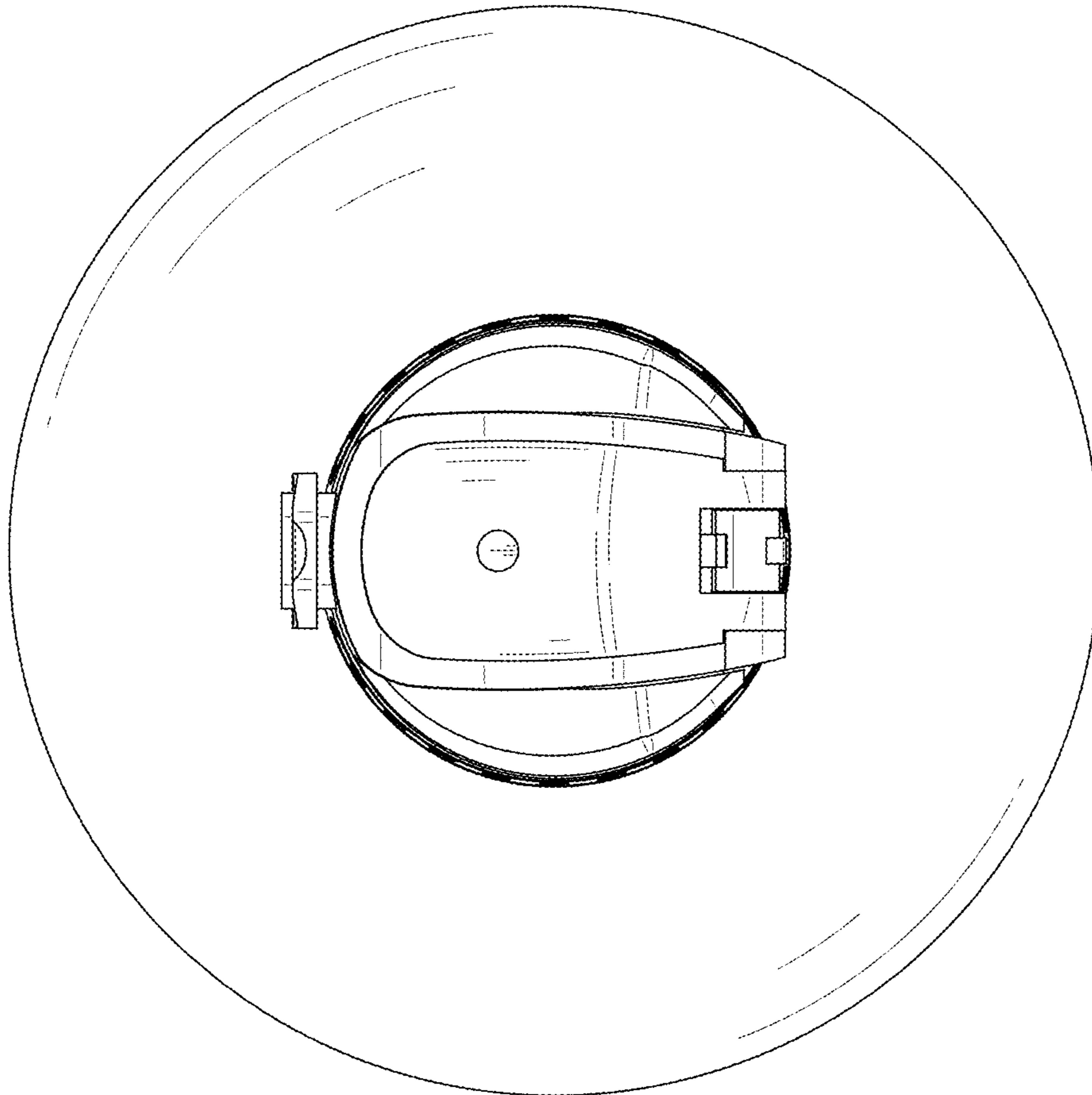

FIG. 7



FIG. 8

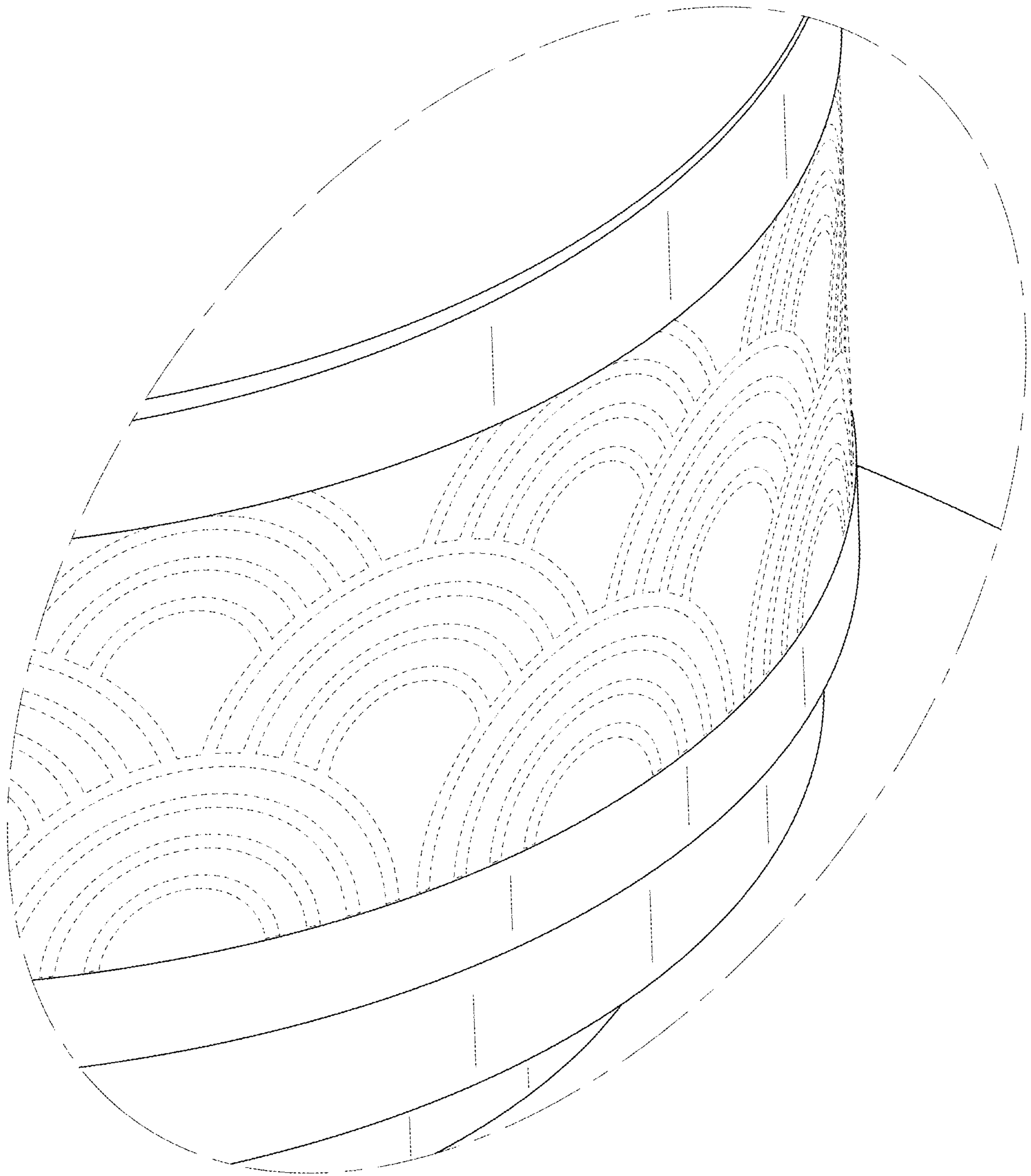

FIG. 9