



US00D950928S

(12) **United States Design Patent**  
**Dunham**

(10) **Patent No.:** **US D950,928 S**

(45) **Date of Patent:** **\*\* May 10, 2022**

(54) **FOOTWEAR**

(71) Applicant: **Target Brands, Inc.**, Minneapolis, MN  
(US)

(72) Inventor: **Austyn Dunham**, Minneapolis, MN  
(US)

(73) Assignee: **Target Brands, Inc.**, Minneapolis, MN  
(US)

(\*\*) Term: **15 Years**

(21) Appl. No.: **29/754,480**

(22) Filed: **Oct. 12, 2020**

(51) **LOC (13) Cl.** ..... **02-04**

(52) **U.S. Cl.**  
USPC ..... **D2/972**

(58) **Field of Classification Search**  
USPC ..... D2/896, 900, 902, 904, 906–908,  
D2/916–924, 925–945, 969–979; 36/1.5,  
36/3 A, 83, 45, 99, 101, 112–116, 136

CPC .... A43B 1/00; A43B 1/02; A43B 1/04; A43B  
3/00; A43B 3/02; A43B 3/06; A43B 3/10;  
A43B 3/12; A43B 3/14; A43B 5/00;  
A43B 5/001; A43B 5/002; A43B 5/008;  
A43B 5/06; A43B 5/10; A43B 5/12;  
A43B 23/00; A43B 23/02; A43B 23/04;  
A43B 23/14; A43B 23/16; A43B 23/17;  
A43B 23/24; A43B 23/25; A43B 23/26;  
A43C 1/00; A43C 5/00; A43C 7/00;  
A43C 9/00; A43C 11/00

See application file for complete search history.

(56) **References Cited**

**U.S. PATENT DOCUMENTS**

3,545,107 A \* 12/1970 Cinquegrana ..... A43B 3/02  
36/50.1  
D234,063 S \* 1/1975 Famolare, Jr. .... D2/911

D282,408 S \* 2/1986 Nissenbaum ..... D2/910  
D290,062 S \* 6/1987 Valori ..... D2/899  
D386,601 S \* 11/1997 Cass ..... D2/972  
D423,197 S \* 4/2000 Yang ..... D2/897  
D432,292 S \* 10/2000 Kim ..... D2/902  
D499,233 S 12/2004 Sedlbauer  
D516,285 S 3/2006 Sedlbauer  
D517,791 S 3/2006 Sedlbauer  
D517,792 S 3/2006 Sedlbauer  
D524,019 S 7/2006 Matis et al.  
D539,024 S 3/2007 Belley et al.  
D547,540 S 7/2007 Maderspach  
D556,438 S 12/2007 Maderspach  
D575,951 S 9/2008 St-Louis  
D582,651 S 12/2008 Andersen et al.  
D599,539 S 9/2009 St-Louis  
D626,728 S \* 11/2010 Tzenos ..... D2/896

(Continued)

*Primary Examiner* — Jonathan J Han

(74) *Attorney, Agent, or Firm* — Merchant & Gould P.C.

(57) **CLAIM**

The ornamental design for a footwear, as shown and described.

**DESCRIPTION**

FIG. 1 is a front, top and right side perspective view of a footwear according to the new design;  
FIG. 2 is a front elevation view of the footwear of FIG. 1;  
FIG. 3 is a back elevation view of the footwear of FIG. 1;  
FIG. 4 is a left side elevation view of the footwear of FIG. 1;  
FIG. 5 is a right side elevation view of the footwear of FIG. 1; and,  
FIG. 6 is a top plan view of the footwear of FIG. 1.  
In the drawings, the bold broken lines within the shaded areas represent stitching and are part of the claimed design. The portions of the footwear shown in non-bold broken lines form no part of the claimed design.

**1 Claim, 6 Drawing Sheets**

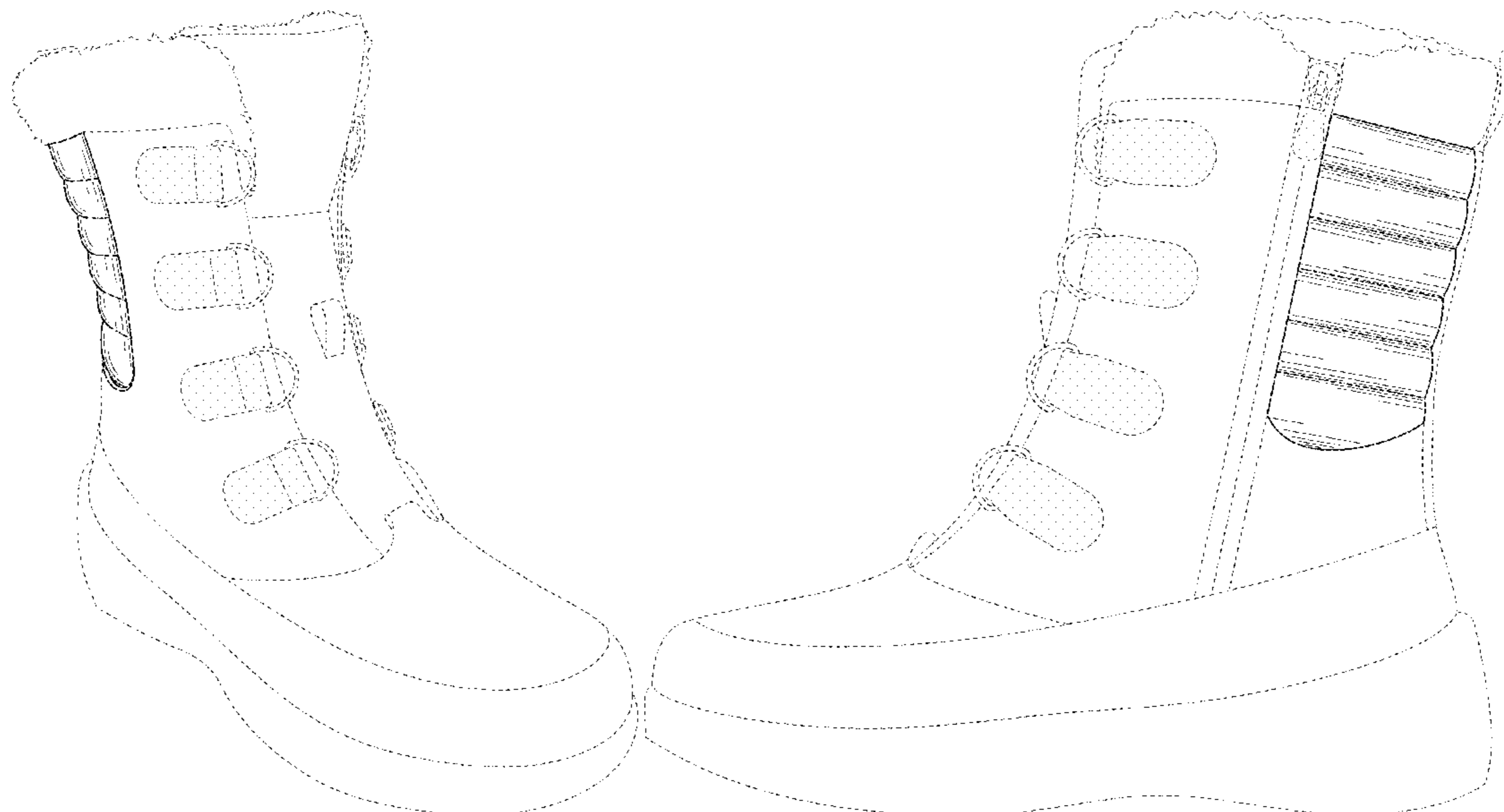

(56)

References Cited

U.S. PATENT DOCUMENTS

D629,597 S	*	12/2010	Ng	.....	D2/970	D754,425 S		4/2016	Deas	
D631,645 S	*	2/2011	Glennie	.....	D2/910	D772,549 S	*	11/2016	Chung	..... D2/970
D632,882 S		2/2011	O'Rorke			D779,183 S	*	2/2017	Arizumi	..... D2/969
D639,032 S	*	6/2011	Mitchell	.....	D2/911	D783,998 S	*	4/2017	Anceresi	..... D2/972
D648,929 S		11/2011	Van Zyll De Jong et al.			D785,311 S	*	5/2017	Yun	..... D2/972
D660,570 S		5/2012	Joseph			D787,798 S	*	5/2017	Portzline	..... D2/970
D662,304 S		6/2012	Spring			D794,935 S	*	8/2017	Dallas	..... D2/970
D664,345 S		7/2012	Joseph			D795,541 S		8/2017	Henrichot et al.	
D677,458 S	*	3/2013	Denniston	.....	D2/970	D802,288 S	*	11/2017	Winfield	..... D2/972
D677,871 S		3/2013	Portzline			D816,313 S	*	5/2018	Ringholz	..... D2/970
D677,873 S		3/2013	Portzline			D838,455 S	*	1/2019	Strother	..... D2/970
D678,666 S		3/2013	Portzline			D846,254 S	*	4/2019	Strother	..... D2/969
D699,932 S		2/2014	Lubart			D858,951 S	*	9/2019	Luh	..... D2/900
D701,024 S		3/2014	Youngs et al.			D866,934 S		11/2019	Zeng	
D701,372 S		3/2014	Portzline			D868,434 S	*	12/2019	Wu	..... D2/910
D701,377 S		3/2014	Spring			D870,426 S	*	12/2019	Zeng	..... D2/943
D701,683 S		4/2014	Neely			D874,808 S		2/2020	Prochmann	
D704,928 S	*	5/2014	Roundhouse	.....	D2/970	D896,494 S	*	9/2020	Sebastian	..... D2/970
D740,534 S		10/2015	Spring			D928,495 S	*	8/2021	Hannah	..... D2/972
						2008/0163516 A1	*	7/2008	Camarillo	..... A43B 11/00 36/136

\* cited by examiner

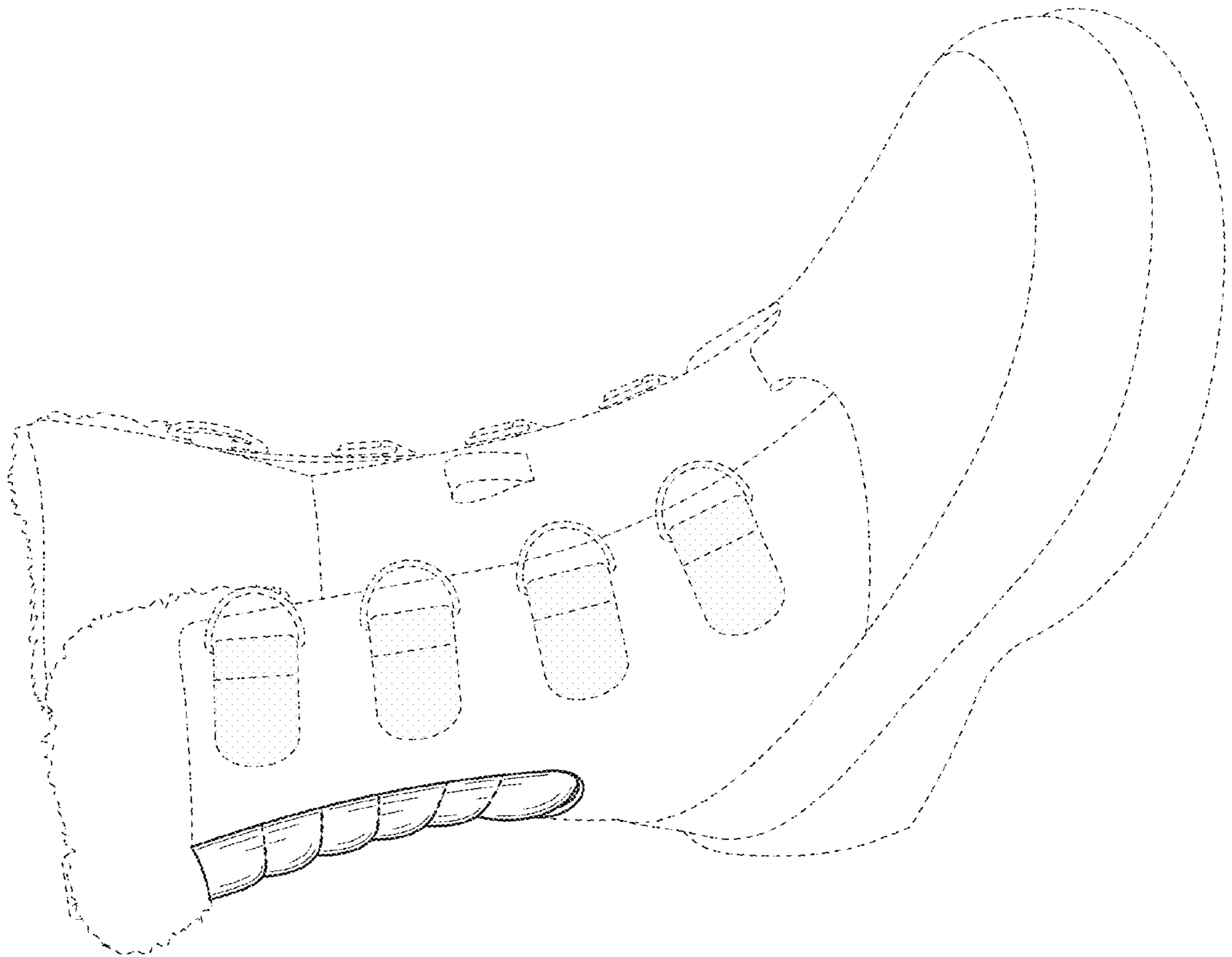

FIG. 1

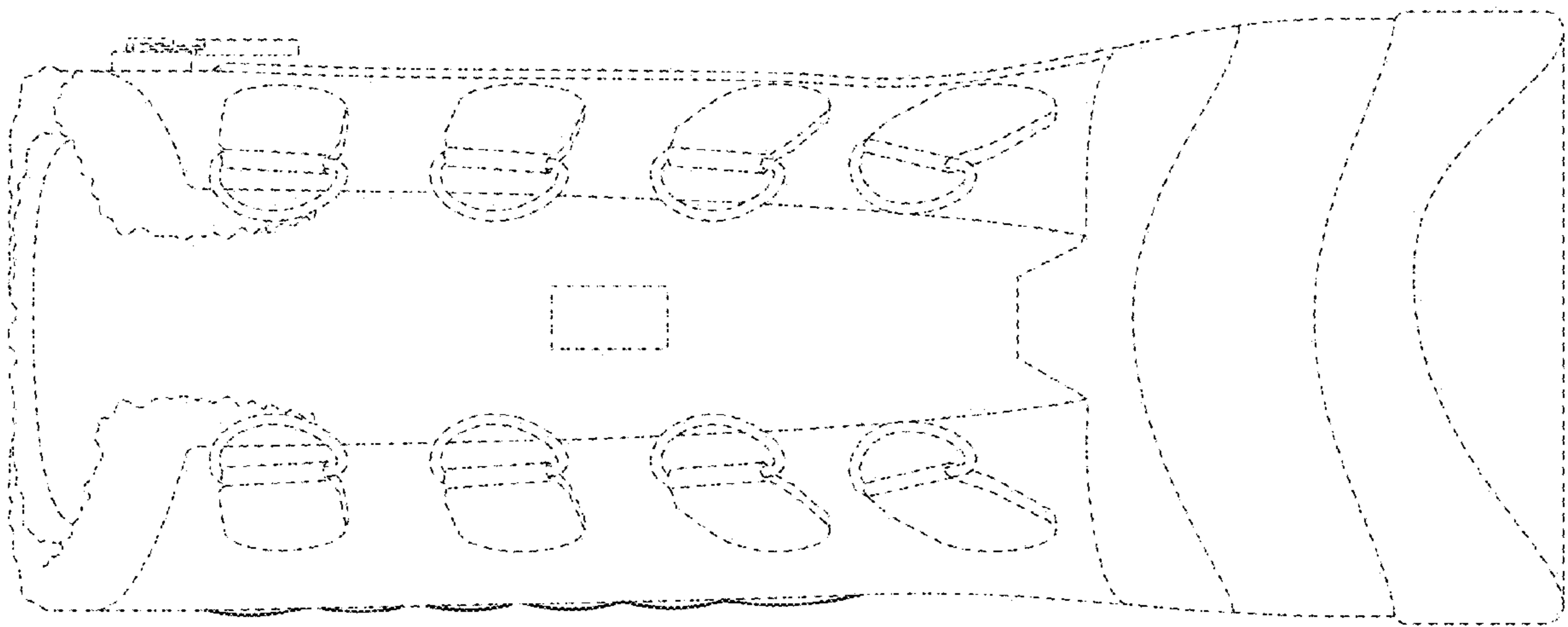

FIG. 2

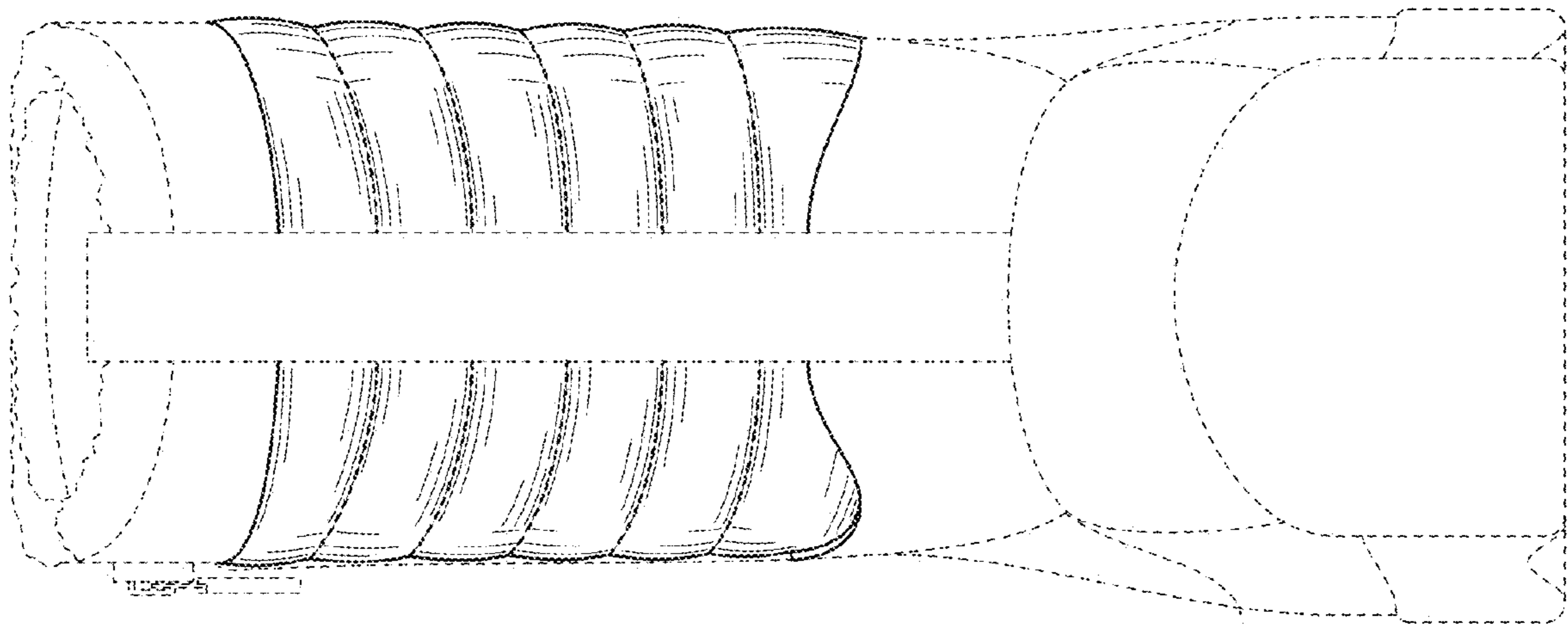

FIG. 3

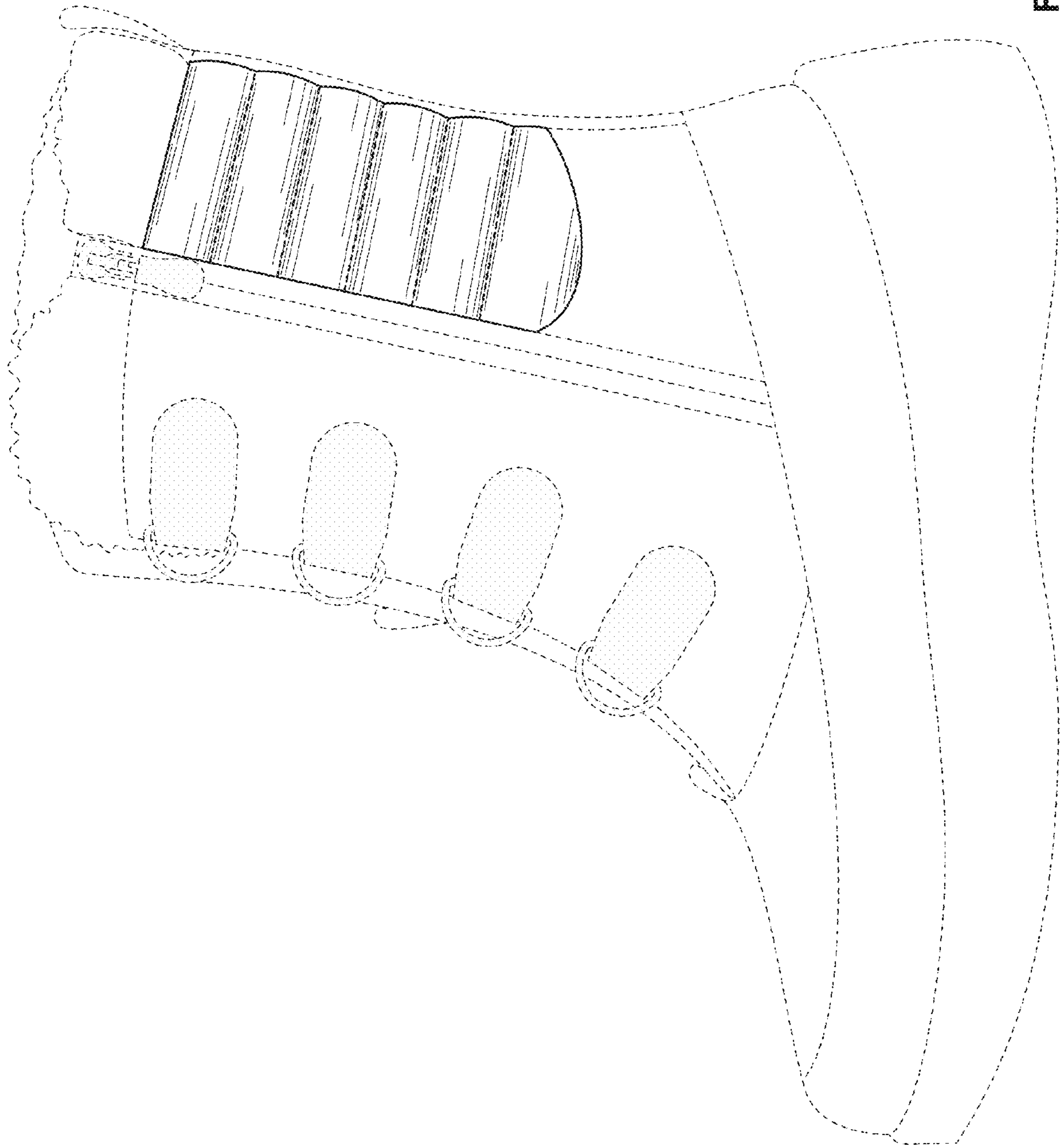

FIG. 4

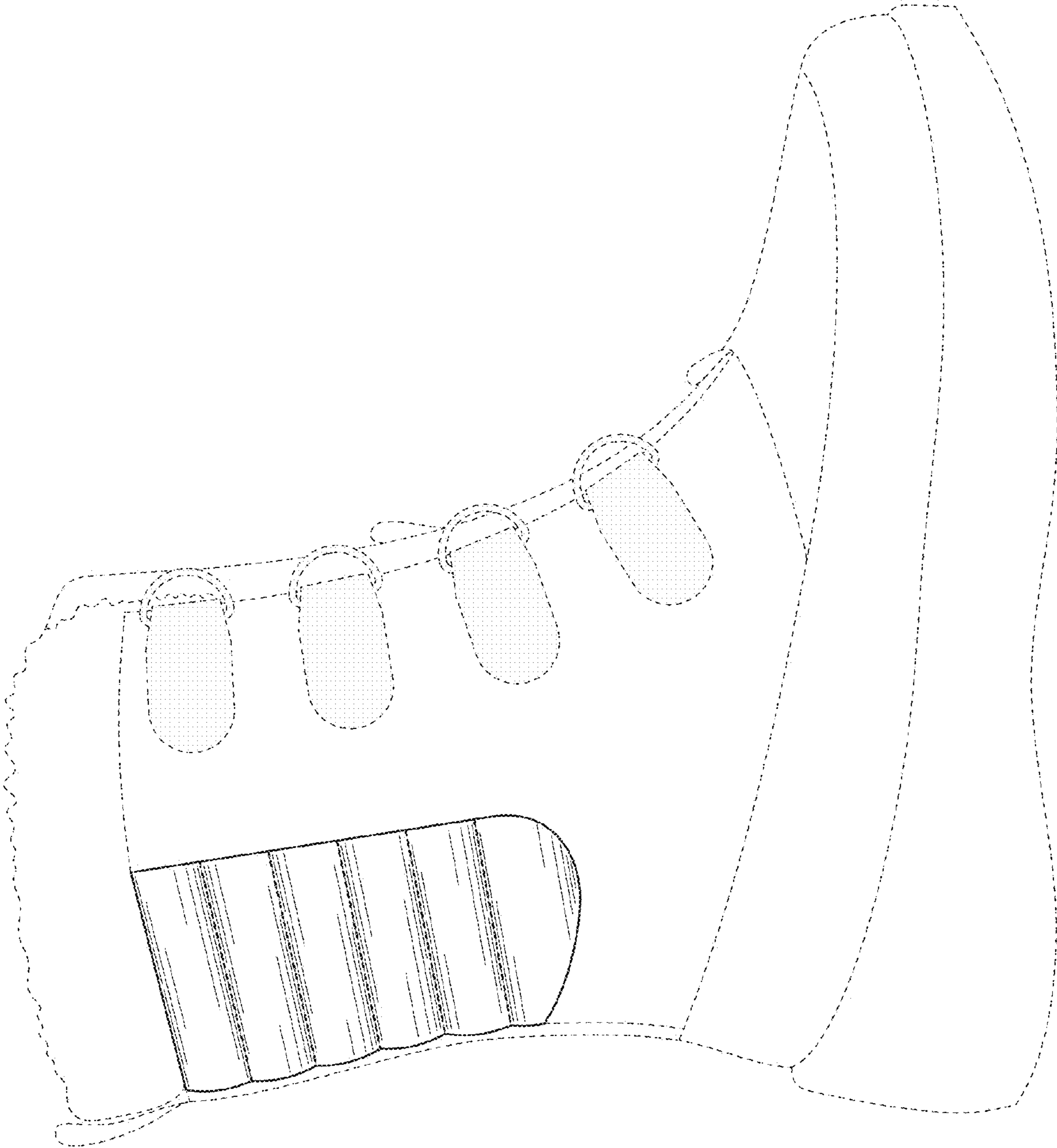

FIG. 5

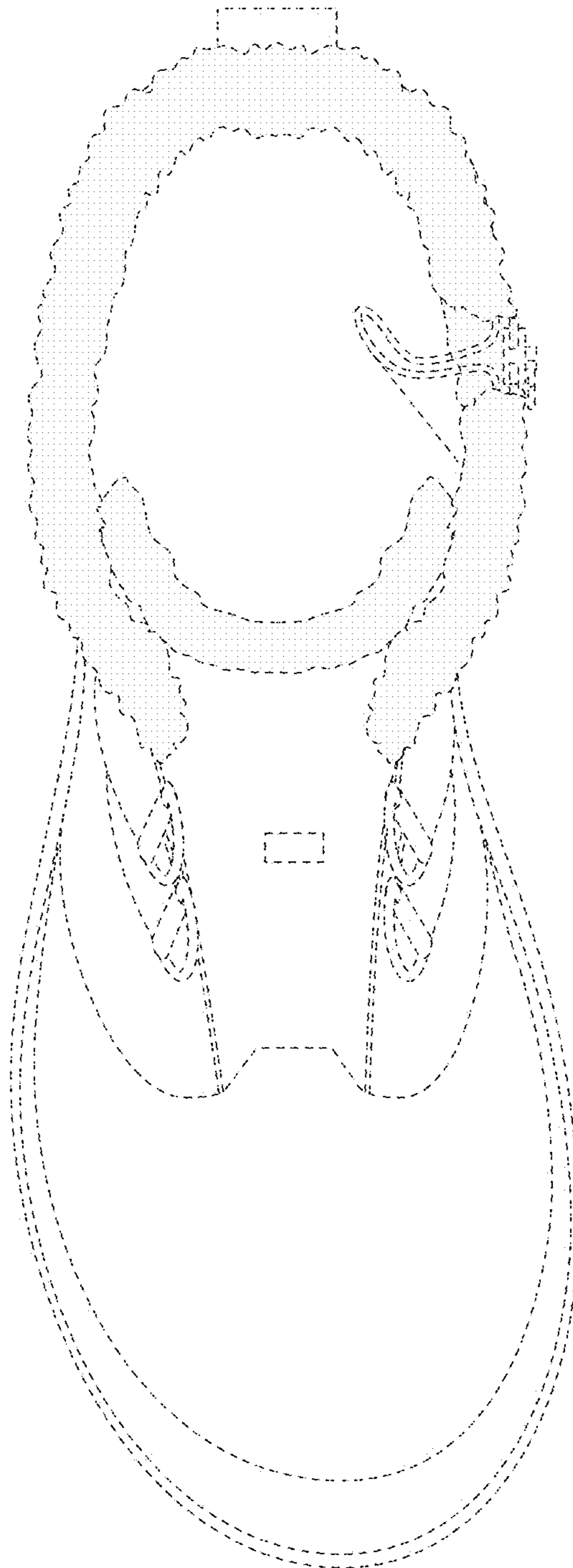

FIG. 6