



US00D950730S

(12) **United States Design Patent**  
**Huber et al.**

(10) **Patent No.:** **US D950,730 S**

(45) **Date of Patent:** **\*\* May 3, 2022**

(54) **MEDICAL IMPLANT DEVICE**

(71) Applicant: **LifeNet Health**, Virginia Beach, VA  
(US)

(72) Inventors: **Alexander Huber**, Chesapeake, VA  
(US); **Rudy Rodriguez**, Virginia Beach,  
VA (US); **Adam Entsminger**, Virginia  
Beach, VA (US)

(73) Assignee: **LifeNet Health**, Virginia Beach, VA  
(US)

(\*\*) Term: **15 Years**

(21) Appl. No.: **29/716,271**

(22) Filed: **Dec. 9, 2019**

(51) **LOC (13) Cl.** ..... **24-03**

(52) **U.S. Cl.**  
USPC ..... **D24/155**

(58) **Field of Classification Search**  
USPC ..... D15/199; D24/155, 171, 231, 101, 102,  
D24/104, 133, 141, 188, 190, 193, 194,  
(Continued)

(56) **References Cited**

**U.S. PATENT DOCUMENTS**

4,969,458 A \* 11/1990 Wiktor ..... A61F 2/885  
623/1.11  
5,445,594 A \* 8/1995 Elist ..... A61F 2/26  
600/38

(Continued)

**OTHER PUBLICATIONS**

Science Translational Medicine, "Mitigation of tracheobronchomalacia with 3D-printed personalized medical devices", first available Apr. 29, 2015. (<https://stm.sciencemag.org/content/7/285/285ra64.full>) (Year: 2015).\*

(Continued)

*Primary Examiner* — Lauren D McVey

*Assistant Examiner* — Justin A Johnson

(74) *Attorney, Agent, or Firm* — RatnerPrestia

(57) **CLAIM**

The ornamental design for a medical implant device, as shown and described.

**DESCRIPTION**

FIG. 1 is an isometric view of a medical implant device according to a first embodiment;

FIG. 2 is a front elevation view thereof;

FIG. 3 is a rear elevation view thereof;

FIG. 4 is an elevation view thereof from the right side;

FIG. 5 is an elevation view thereof from the left side;

FIG. 6 is a top plan view thereof; and

FIG. 7 is a bottom plan view thereof.

FIG. 8 is an isometric view of a medical implant device according to a second embodiment;

FIG. 9 is a front elevation view thereof;

FIG. 10 is a rear elevation view thereof;

FIG. 11 is an elevation view thereof from the right side;

FIG. 12 is an elevation view thereof from the left side;

FIG. 13 is a top plan view thereof; and

FIG. 14 is a bottom plan view thereof.

FIG. 15 is an isometric view of a medical implant device according to a third embodiment;

FIG. 16 is a front elevation view thereof;

FIG. 17 is a rear elevation view thereof;

FIG. 18 is an elevation view thereof from the right side;

FIG. 19 is an elevation view thereof from the left side;

FIG. 20 is a top plan view thereof; and

FIG. 21 is a bottom plan view thereof.

FIG. 22 is an isometric view of a medical implant device according to a fourth embodiment;

FIG. 23 is a front elevation view thereof;

FIG. 24 is a rear elevation view thereof;

FIG. 25 is an elevation view thereof from the right side;

FIG. 26 is an elevation view thereof from the left side;

FIG. 27 is a top plan view thereof; and

FIG. 28 is a bottom plan view thereof.

FIG. 29 is an isometric view of a medical implant device according to a fifth embodiment;

FIG. 30 is a front elevation view thereof;

(Continued)

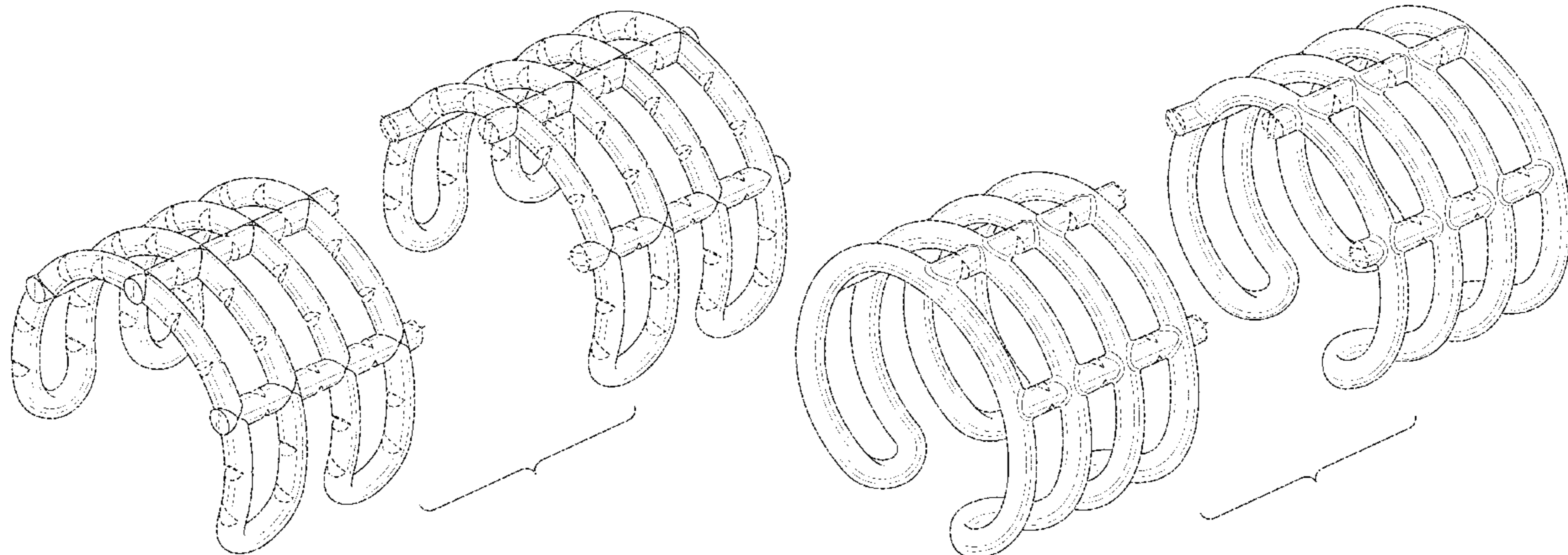



FIG. 31 is a rear elevation view thereof;  
 FIG. 32 is an elevation view thereof from the right side;  
 FIG. 33 is an elevation view thereof from the left side;  
 FIG. 34 is a top plan view thereof; and,  
 FIG. 35 is a bottom plan view thereof.  
 By way of non-limiting example, the medical implant device may be an implantable biomedical tracheal support for an airway.  
 The broken lines immediately adjacent to the shaded areas depict the bounds of the claimed design, while all other broken lines are directed to environment. The broken lines form no part of the claimed design.  
 The separations depicted by the zig-zag break lines are the bounds of the claim and any portion between the break lines forms no part of the claimed design.

**1 Claim, 35 Drawing Sheets**

(58) **Field of Classification Search**

USPC ..... D24/196, 216, 224, 227, 228, 229, 135, D24/152, 217, 200; D2/617; D3/201, D3/203.1, 203.6, 203.7, 304, 306, 314; D8/382; D14/205, 223; D29/123; D28/76, 85  
 CPC .. A41D 19/00; A41D 19/0017; A41D 19/015; A41D 19/0055; A61B 17/80; A61B 2017/00292; A61B 2017/00796; A61B 2017/00969; A61B 50/30; A61B 50/33; A61B 17/8033; A61B 17/8038; A61B 17/8042; A61B 17/8047; A61B 17/8052; A61B 17/8057; A61B 17/8061; A61B 17/86; A61B 17/68; A61B 17/683; A61B 2017/564; A61B 17/808; A61B 17/8869; A61B 17/8019; A61B 50/34; A61F 2/00; A61F 2/02; A61F 2002/046; A61F 2/20; A61F 2/203; A61F 2/28; A61F 2/50; A61F 2/82; A61F 2/86; A61F 2/88; A61F 2/885; A61F 2/12; A61F 2/26; A61F 2002/2853; A61F 2/30; A61F 2002/5038; A61F 2002/5058; A61F 2002/5064; A61F 2/52; A61F 2002/526; A61F 2/54; A61F 2/58; A61F 2/583; A61F 2/60; A61F 2/604; A61F 2/64; A61F 2/66; A61F 2002/6614; A61F 2002/6621; A61F 2002/6628; A61F 2/4014; A61F 2002/4018; A61F 2002/4022; A61F 2002/4029; A61F 2002/4033; A61F 2002/4037; A61F 2002/4044; A61F 2002/4051; A61F 2/4059; A61F 2002/4062; A61F 2002/4066; A61F 2002/407; A61F 2002/4074; A61F 2002/4077; A61F 2/4081; A61F 2002/4085; A61F 2002/4088; A61F 2002/4092; A61F 2002/4096; A61F 2/442; A61F 2/4425; A61F 2/4455; A61F 2/4465; A61F 2/447; A61F 2/4611; A61F

2002/2817; A61F 2002/2835; A61F 2002/3083; A61F 2002/30092; A61F 2002/30523; A61F 2002/30538; A61F 2/30771; A61F 2/30942; A61F 2002/30617; A61F 2002/30774; A61F 2002/30784; A61F 2002/30892; A61F 2002/30828; A61F 2002/3008; A61F 2002/30428; A61F 2002/30471; A61F 2002/30507; A61F 2002/30904; A61F 2002/30421; A61F 2002/443; A61F 2/30749; A61F 2002/30332; A61F 2002/30336; A61F 2002/30349; A61F 2002/30367; A61F 2002/305; A61F 2002/30878; A61M 16/04; A61N 1/05; A61N 1/0551; A61N 1/20; A61N 1/36071; A61L 27/58; A61L 27/34; A61L 27/3843; A61L 27/24; A61L 2/26; A61L 2202/24; A61K 31/765

See application file for complete search history.

(56) **References Cited**

U.S. PATENT DOCUMENTS

D380,831 S \* 7/1997 Kavteladze ..... A61F 2/885 D24/155  
 5,669,870 A \* 9/1997 Elist ..... A61F 2/26 600/40  
 5,824,040 A \* 10/1998 Cox ..... A61F 2/90 623/1.35  
 D407,818 S \* 4/1999 Mariant ..... A61F 2/04 D24/143  
 2008/0103584 A1 \* 5/2008 Su ..... A61F 2/86 623/1.16  
 2010/0122698 A1 \* 5/2010 Shaffer ..... A61F 2/04 128/204.18  
 2013/0197657 A1 \* 8/2013 Anca ..... A61F 2/04 623/23.7  
 2015/0230948 A1 \* 8/2015 Riina ..... A61F 2/844 623/9  
 2017/0231767 A1 \* 8/2017 Larsen ..... A61F 2/2846 623/23.58  
 2017/0354503 A1 \* 12/2017 Larsen ..... A61F 2/30907  
 2020/0315662 A1 \* 10/2020 Adam ..... A61B 17/869

OTHER PUBLICATIONS

Tree Top Products, "Curve-It Bike Racks", first available Sep. 8, 2016. ([https://www.parkitbikeracks.com/curve-it-bike-racks?sku=7YT7018&st-t=pibrgoogshop&gclid=EAlalQobChMlqvqG8Yik8AIVLAILCR3TwQsxEAkYAyABEgKLg\\_D\\_Bw](https://www.parkitbikeracks.com/curve-it-bike-racks?sku=7YT7018&st-t=pibrgoogshop&gclid=EAlalQobChMlqvqG8Yik8AIVLAILCR3TwQsxEAkYAyABEgKLg_D_Bw)) (Year: 2016).\*

Baptist Health South Florida, "Miami Medicine Institute is First to Implant 3-D Printed 'Graft Cage'", first available Sep. 9, 2020. (<https://baptisthealth.net/baptist-health-news/miami-orthopedics-sports-medicine-institute-is-first-to-implant-3-d-printed-graft-cage-to-heal-long-bone-injury/>) (Year: 2020).\*

Wiley Online Library, "Airway stenting: Technological advancements", first available Mar. 11, 2020. (<https://onlinelibrary.wiley.com/doi/full/10.1111/resp.13801>) (Year: 2020).\*

\* cited by examiner

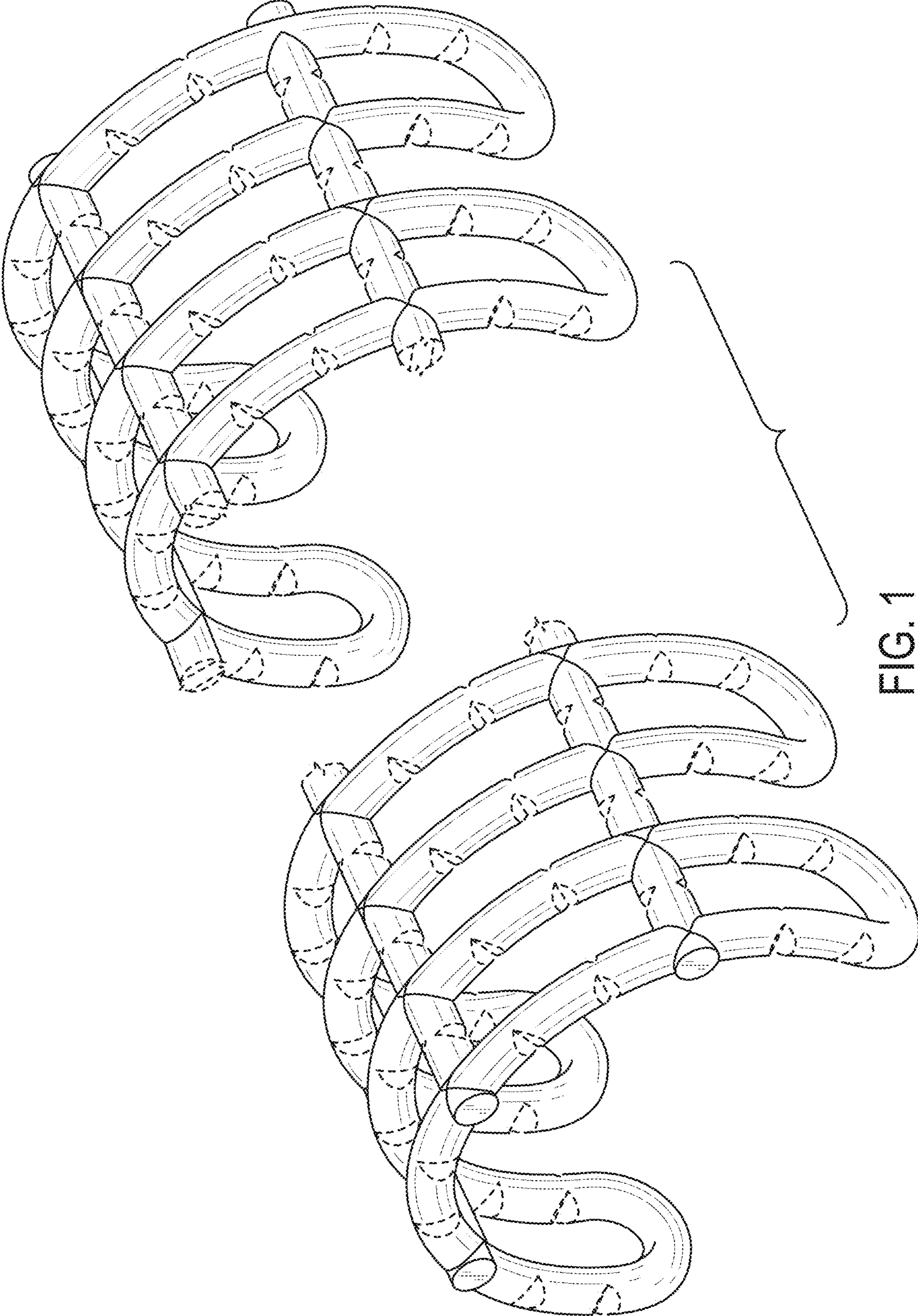

FIG. 1



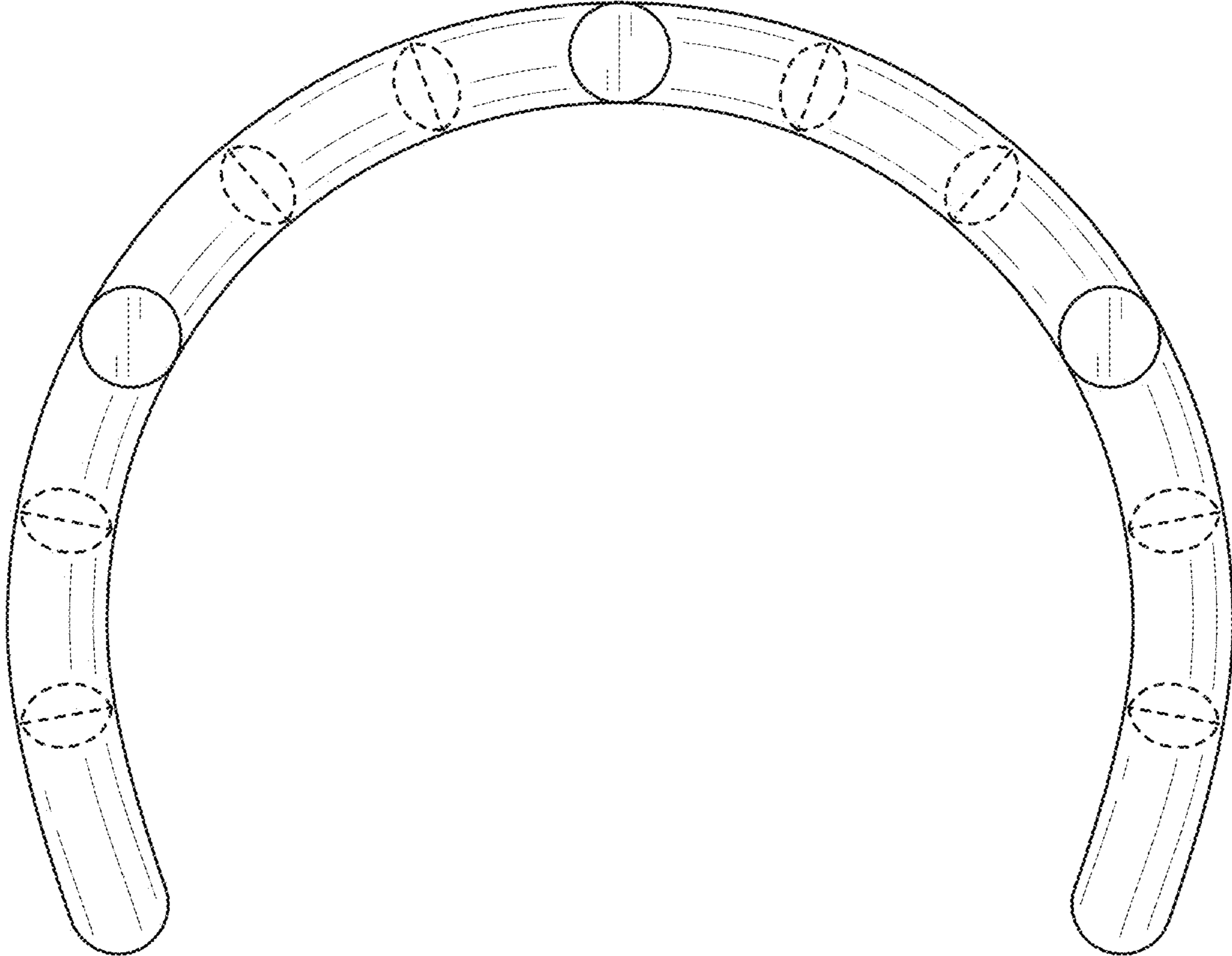

FIG. 2

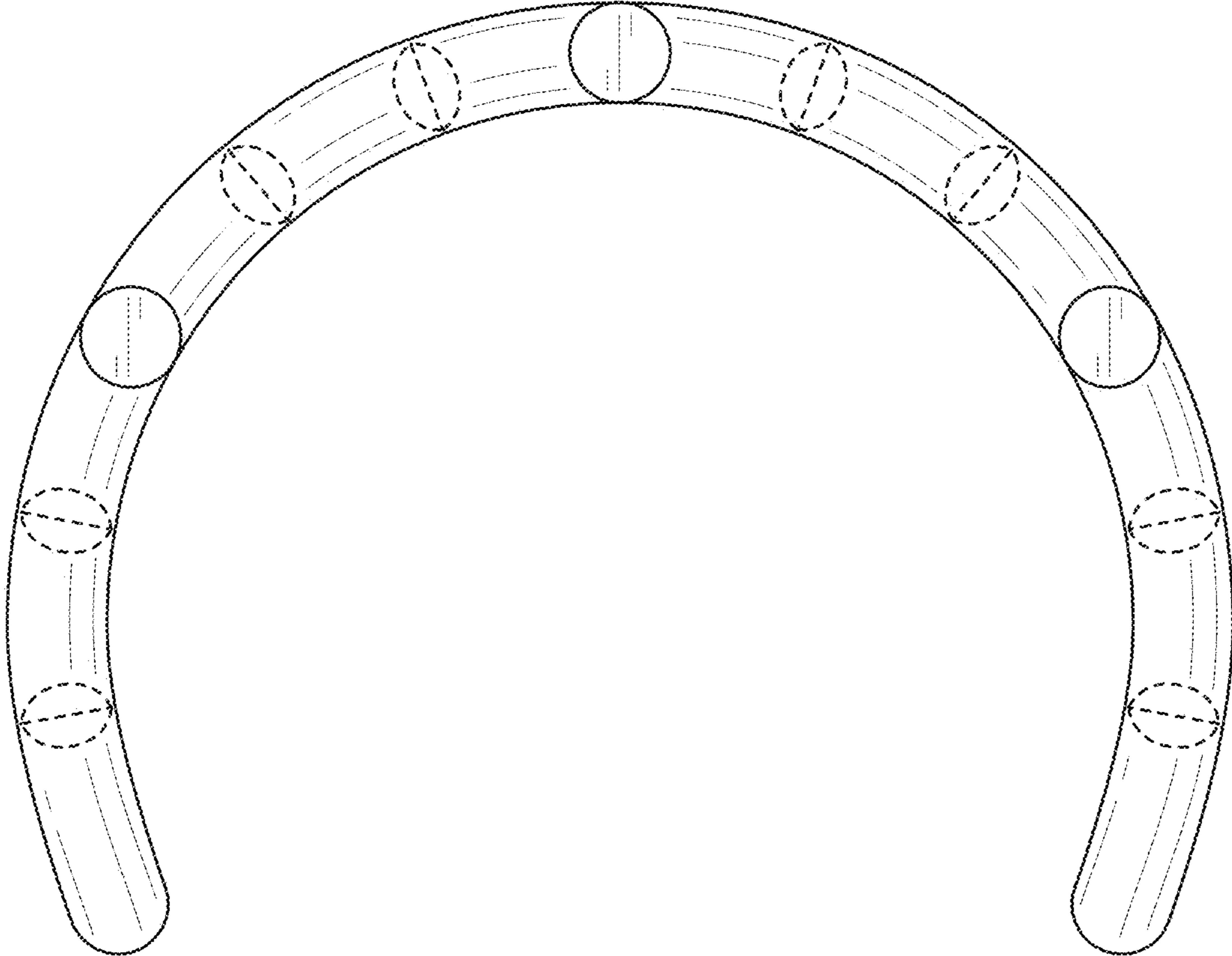

FIG. 3

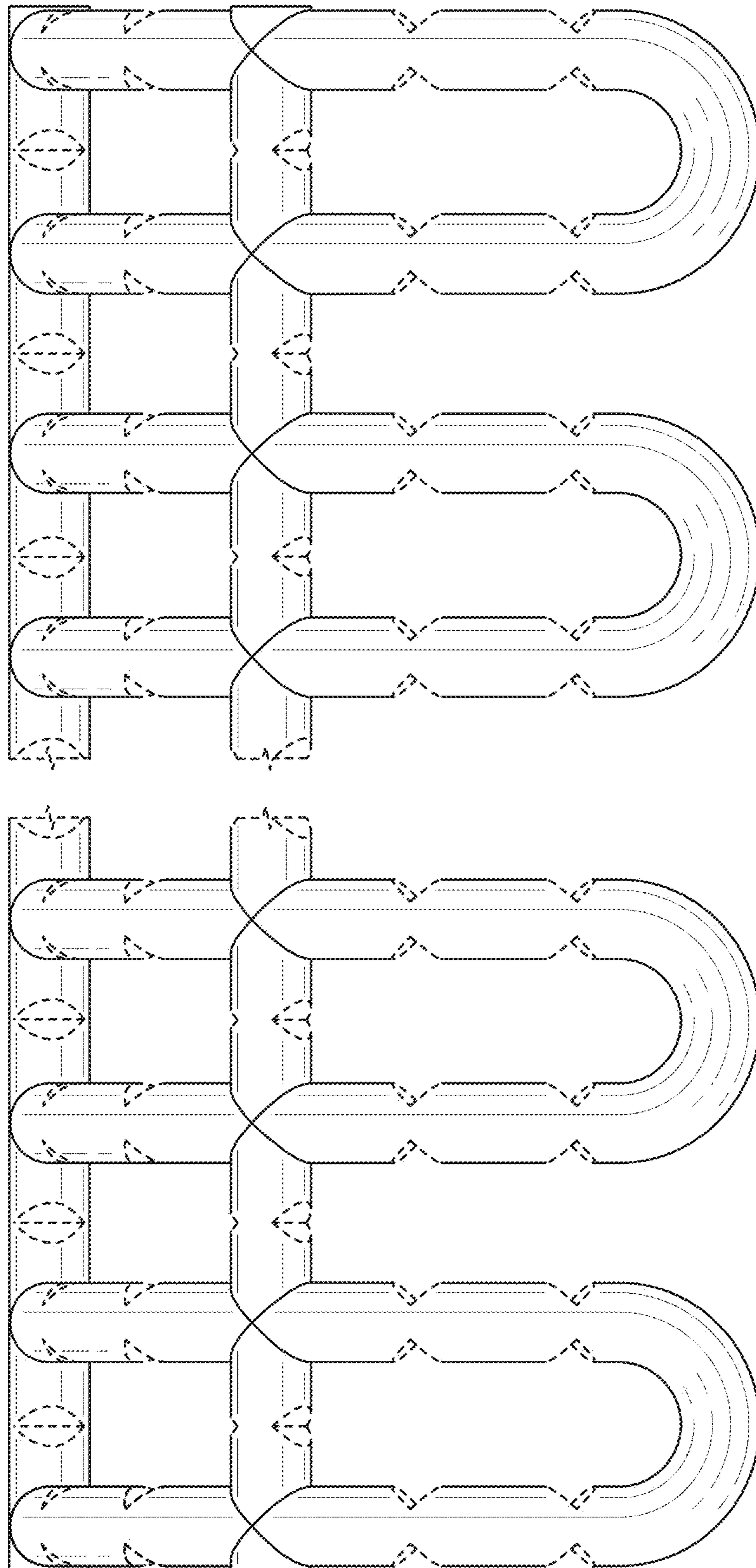

FIG. 4

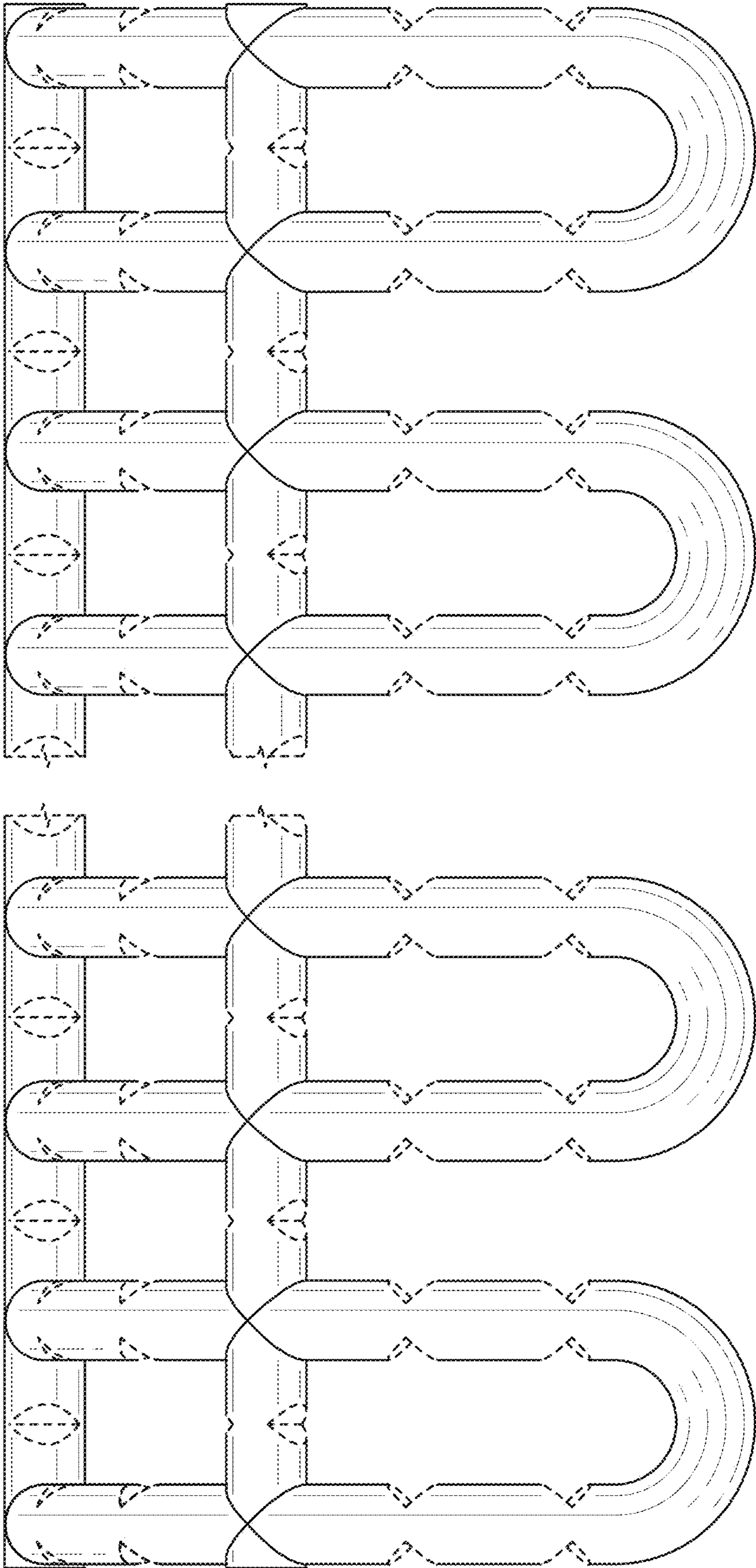

FIG. 5



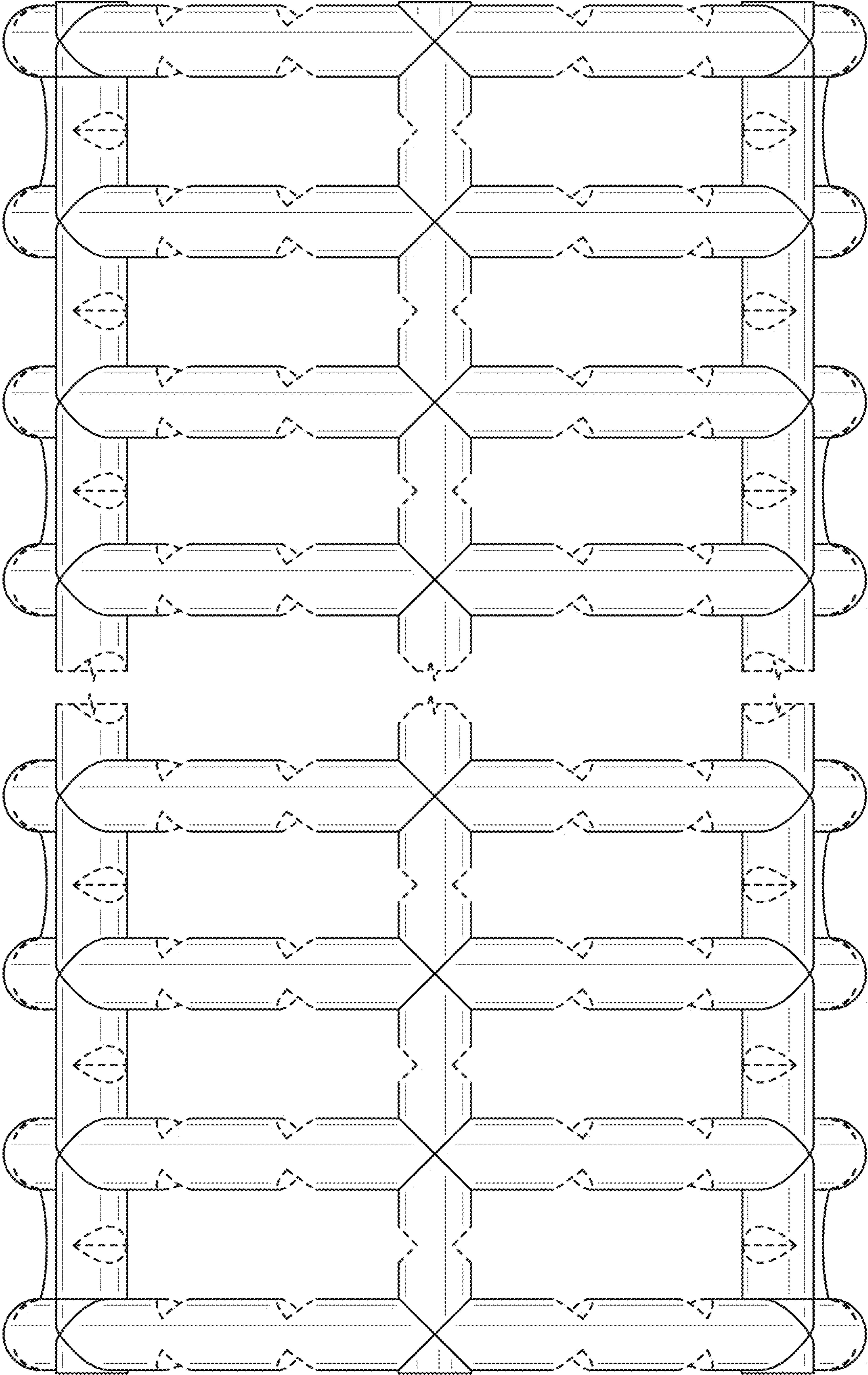

FIG. 6



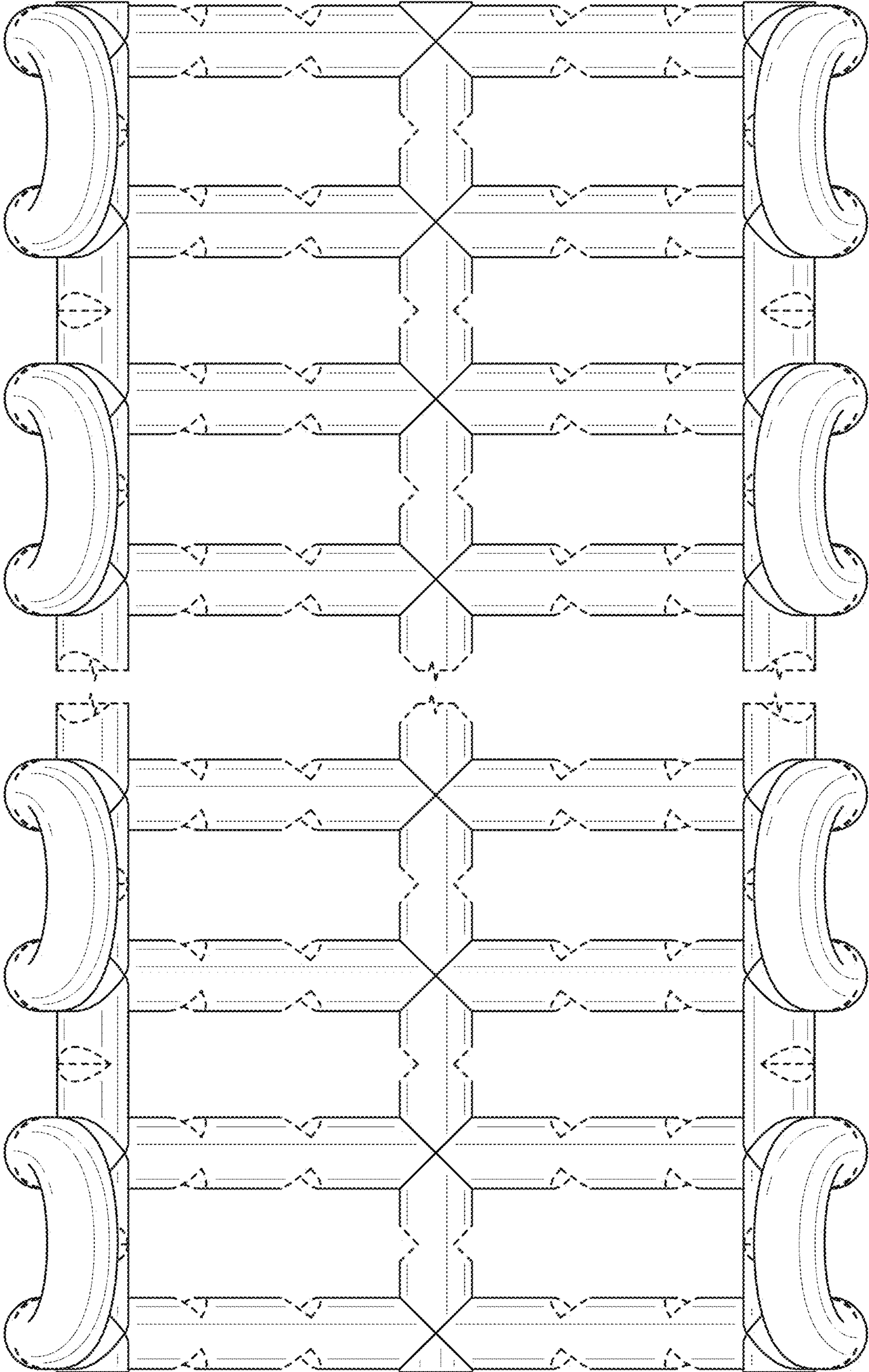

FIG. 7

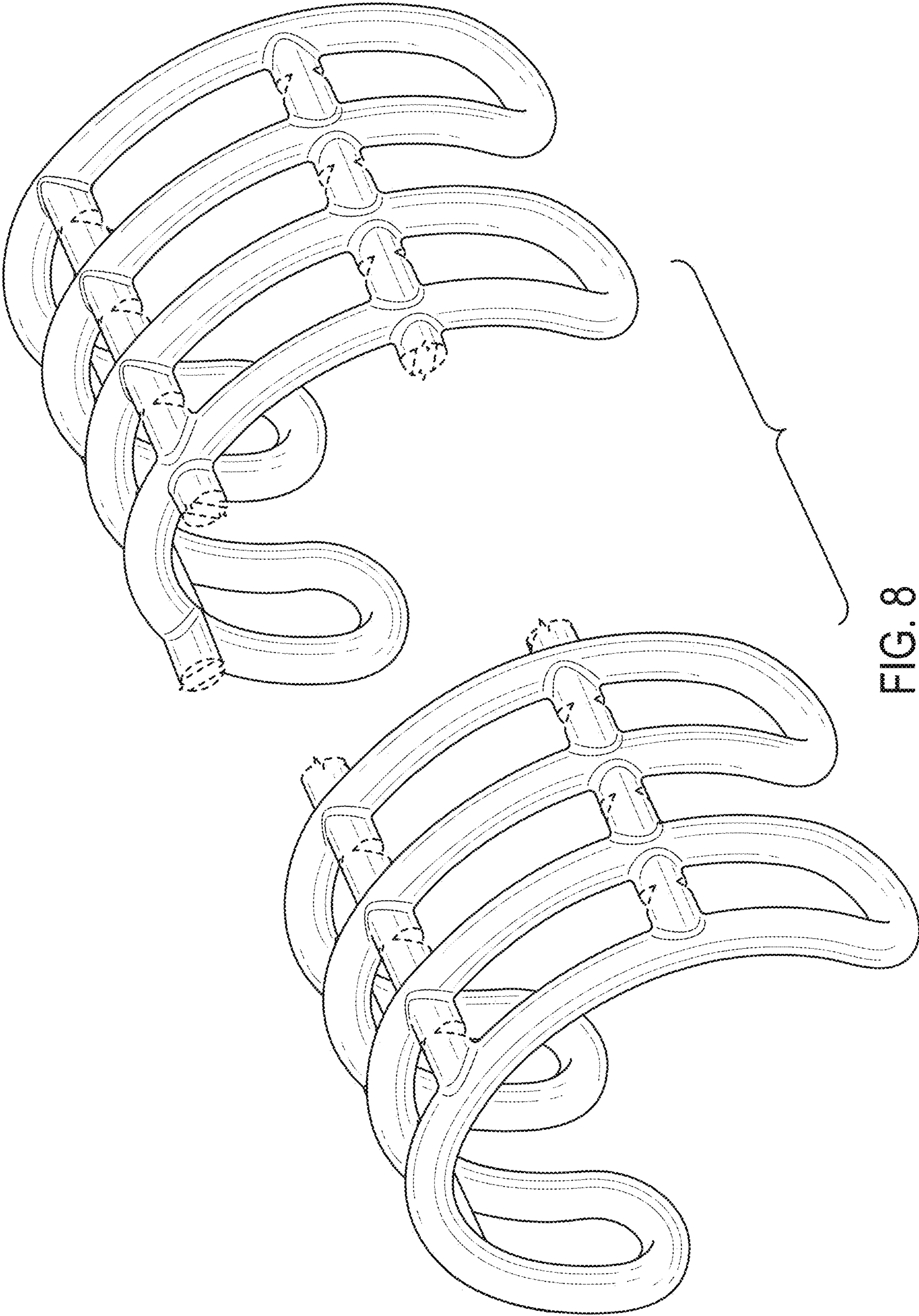

FIG. 8

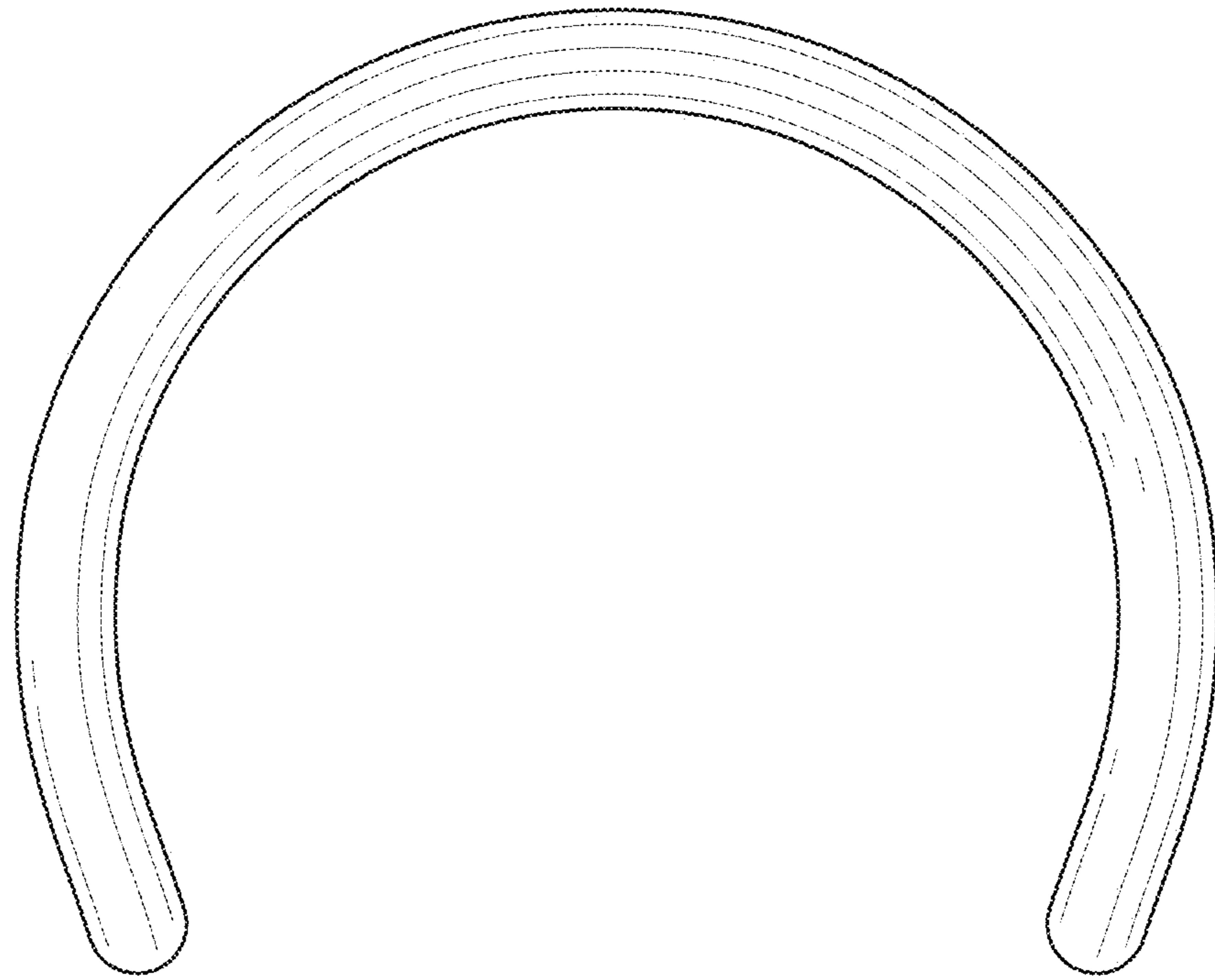

FIG. 9



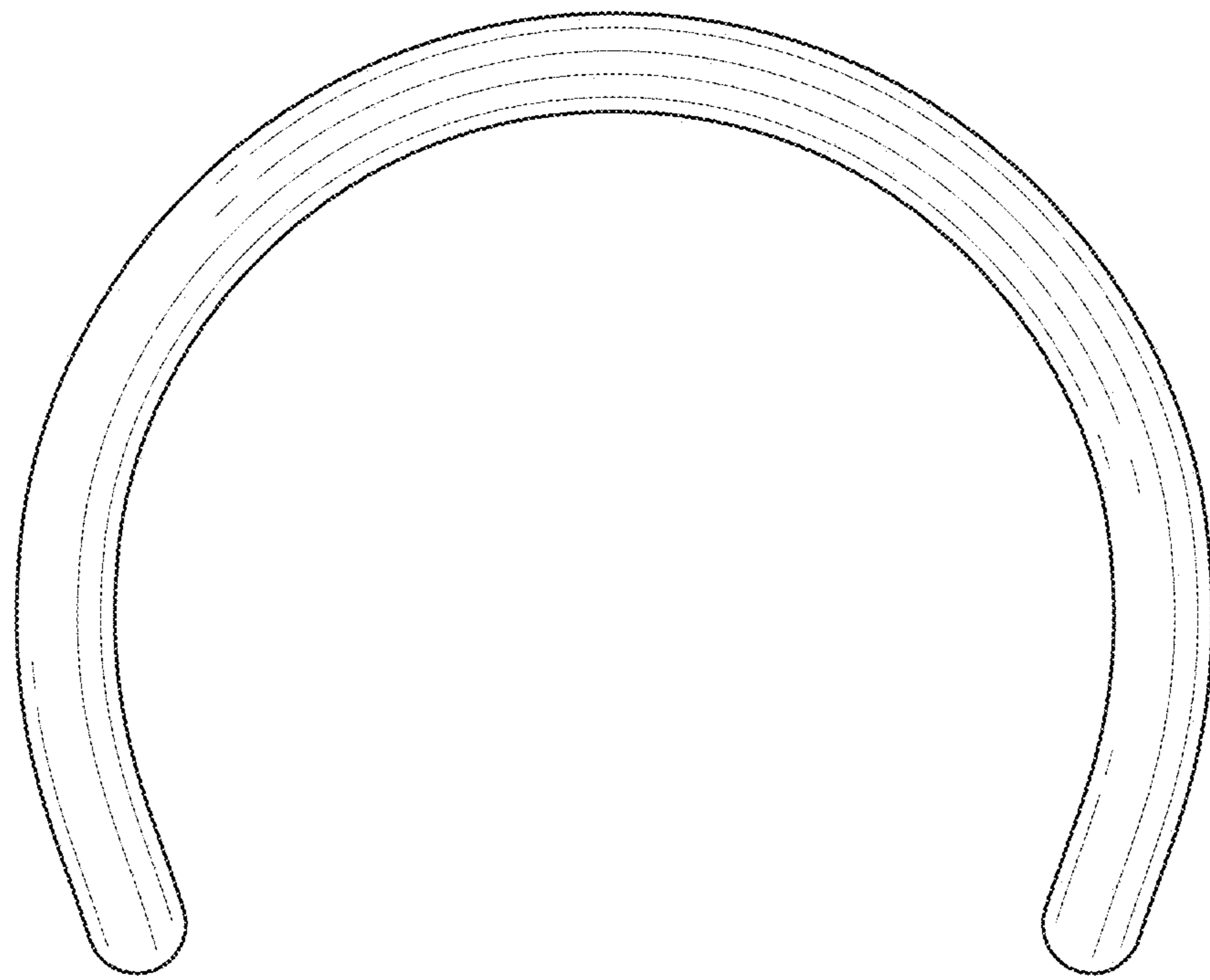

FIG. 10

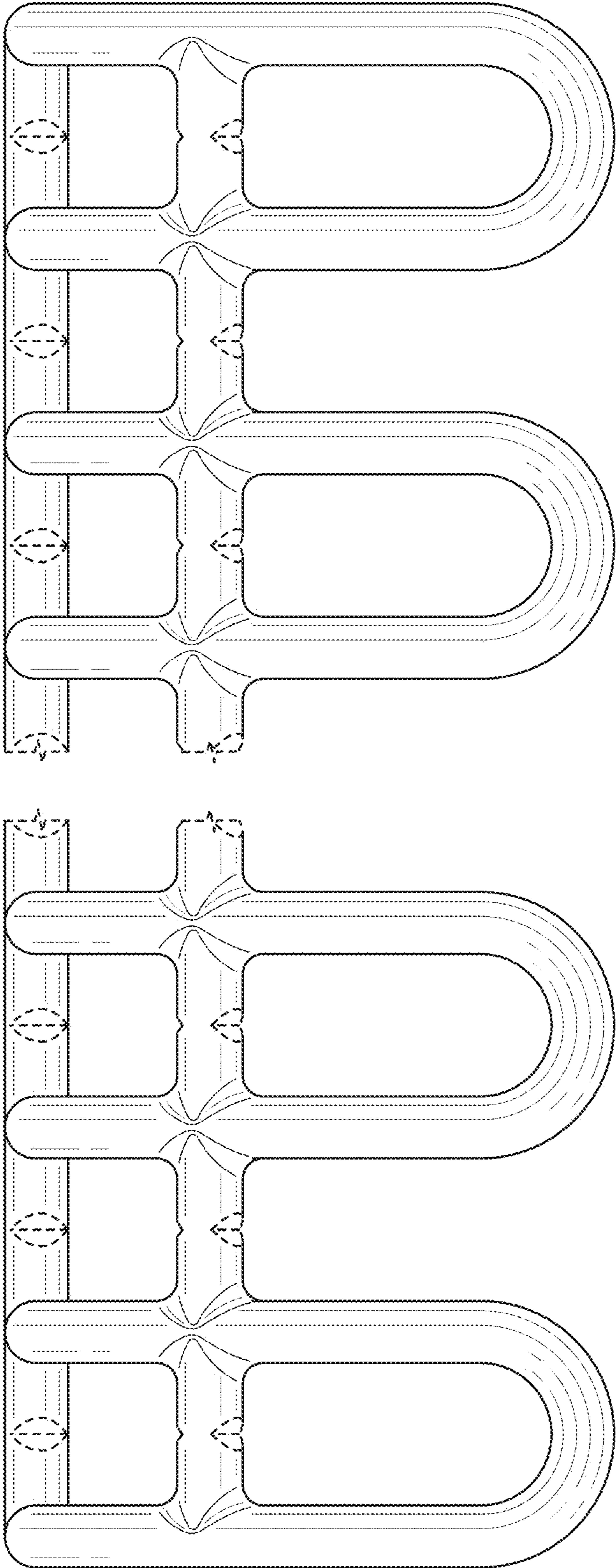

FIG. 11

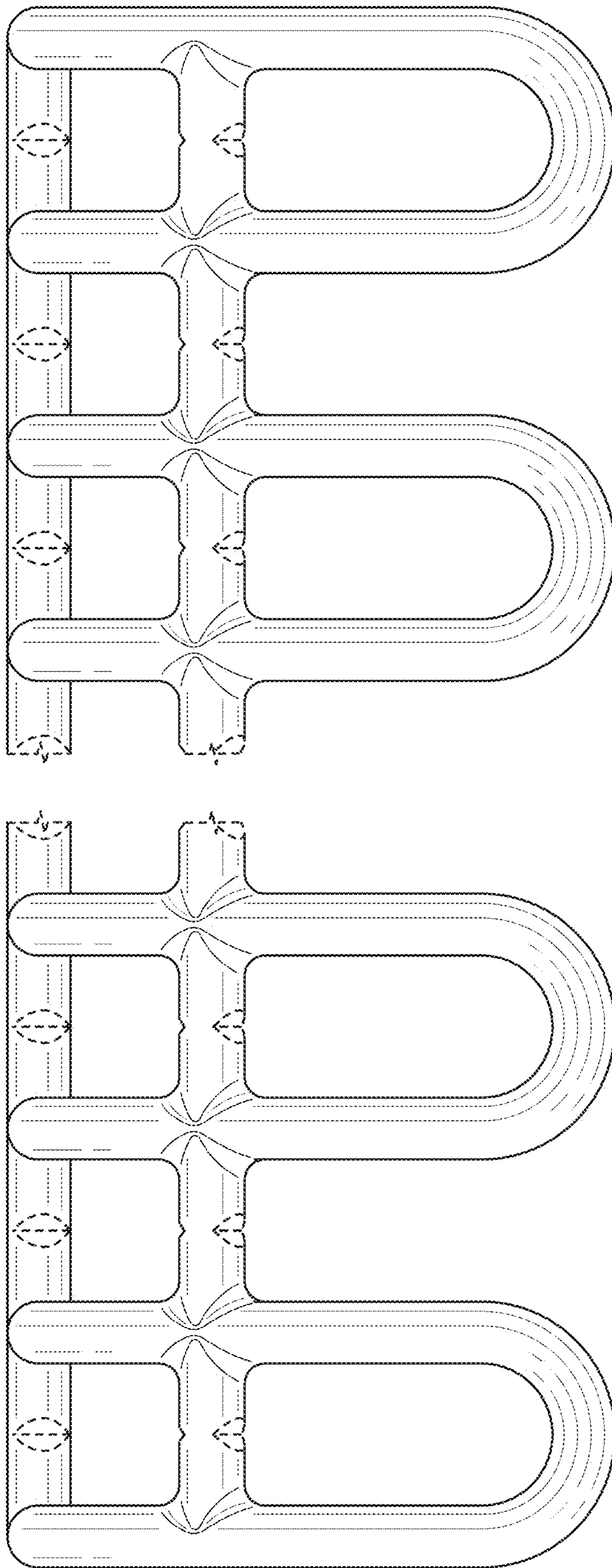

FIG. 12



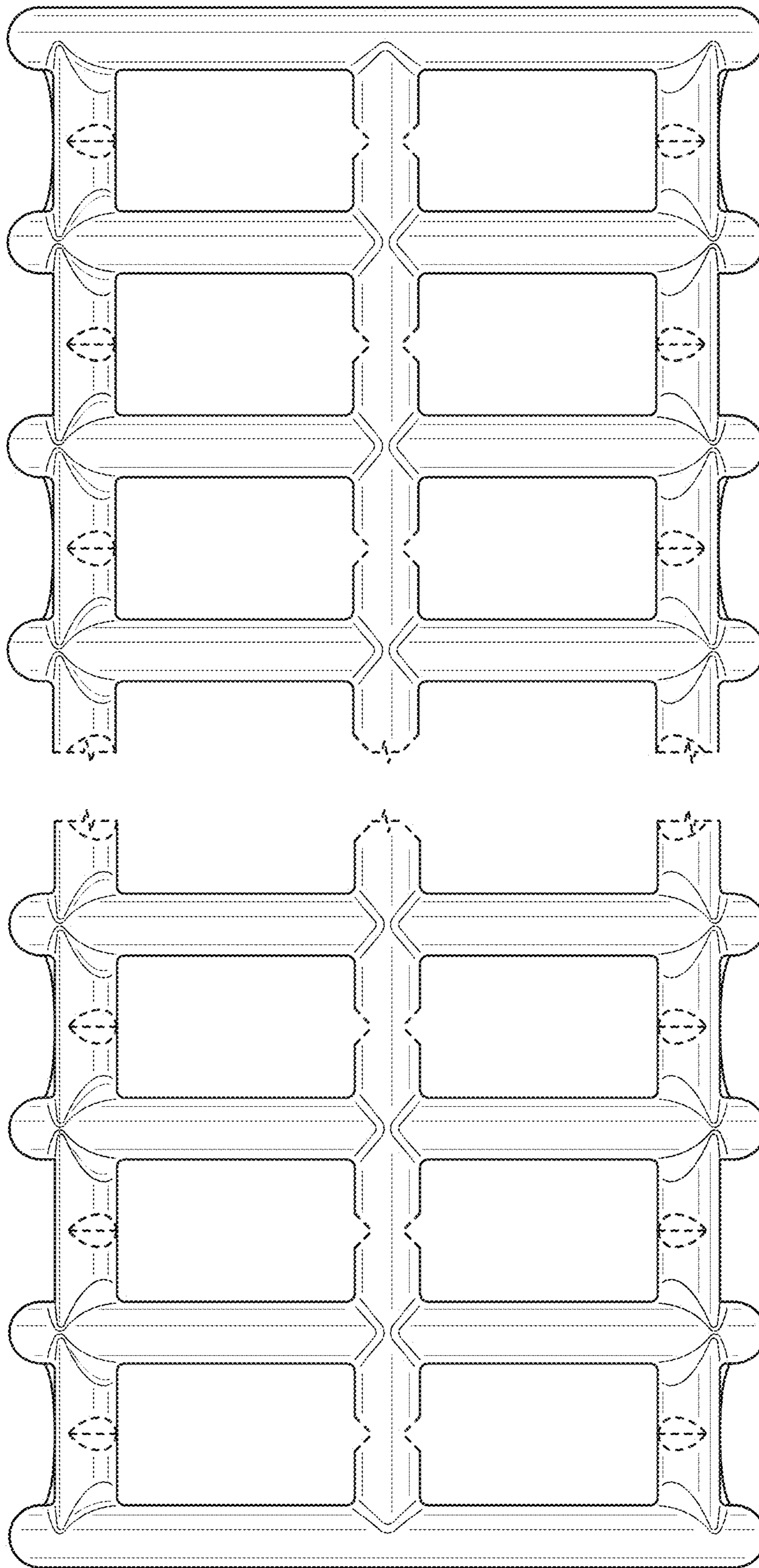

FIG. 13

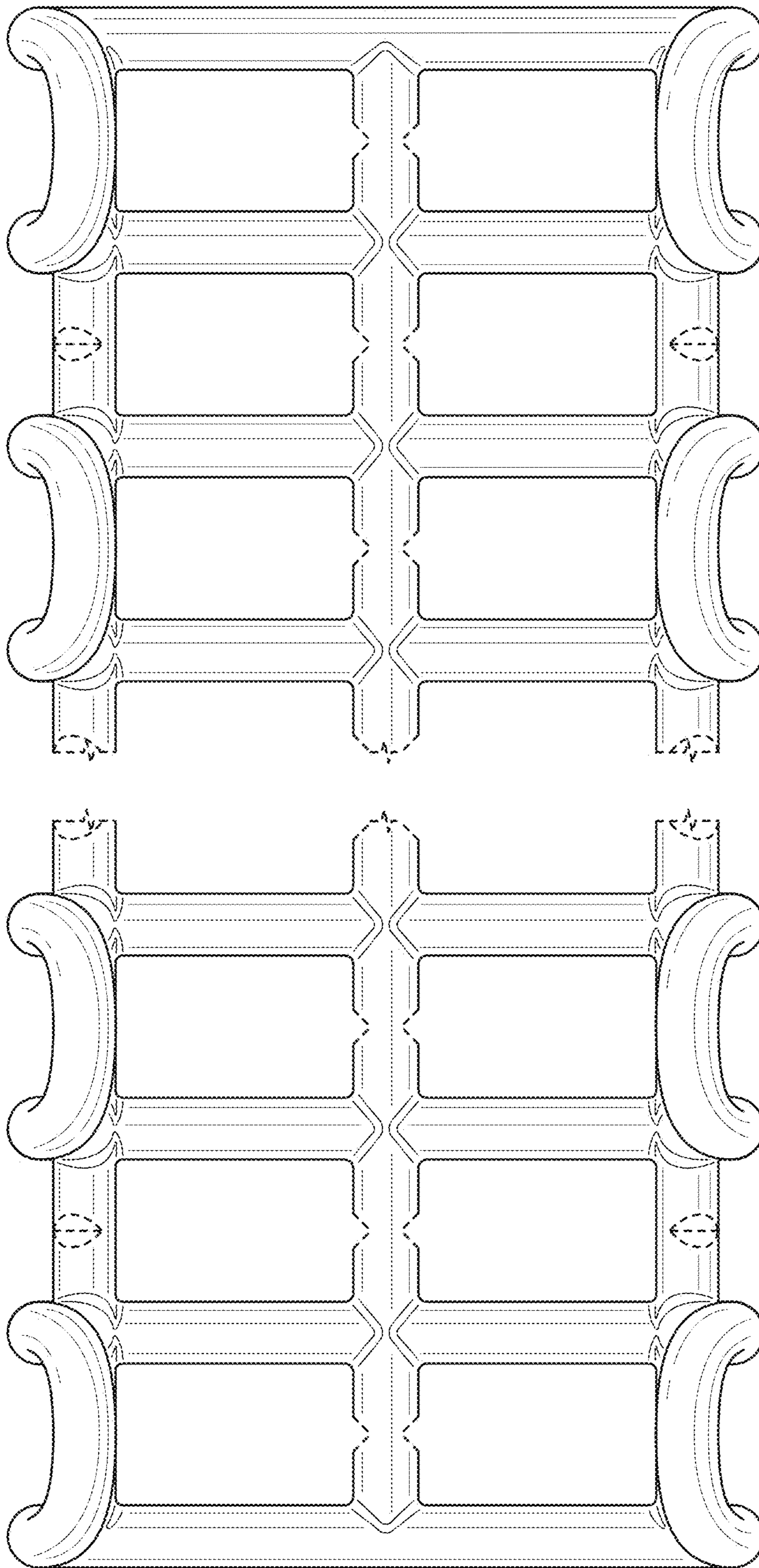

FIG. 14

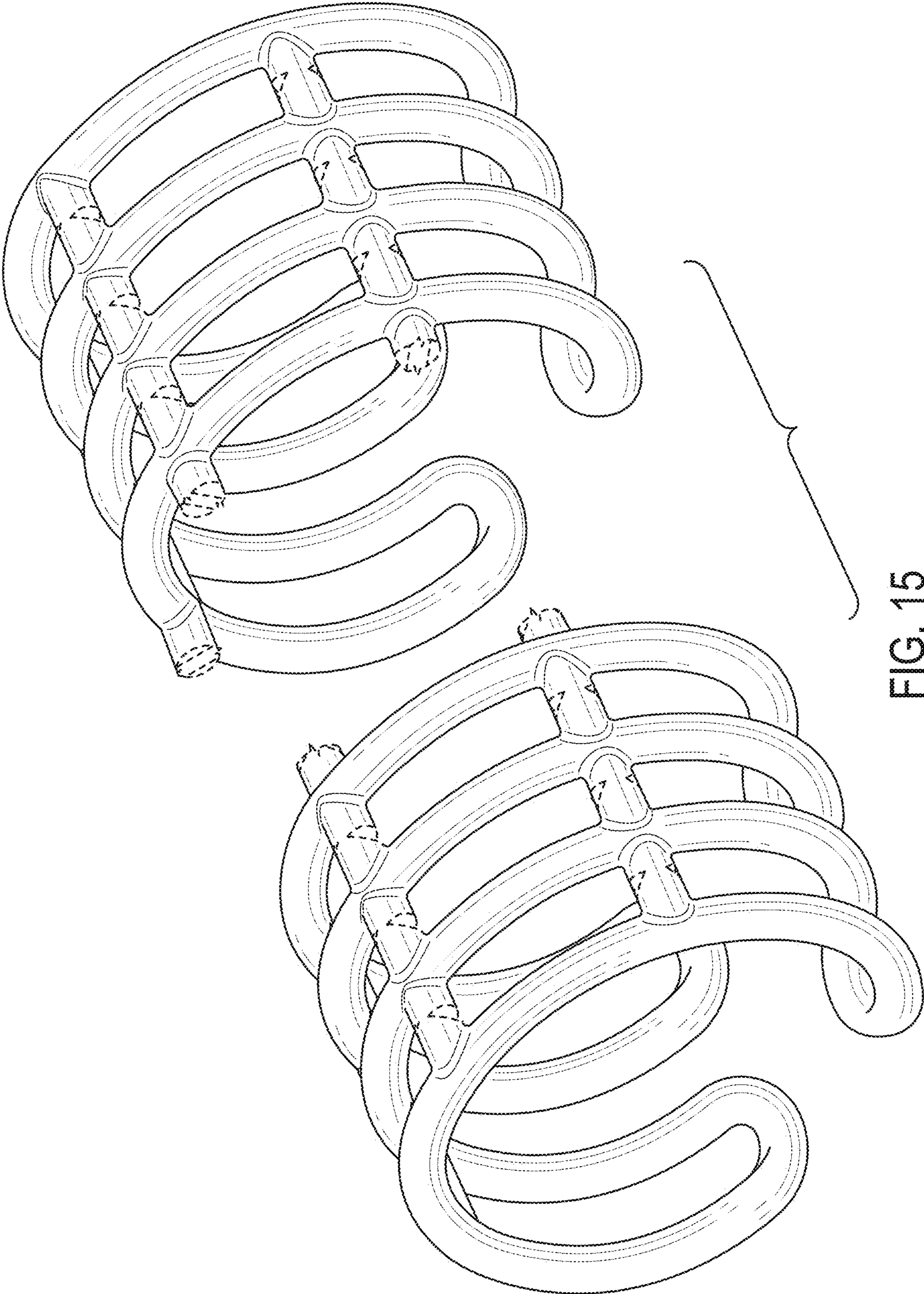

FIG. 15



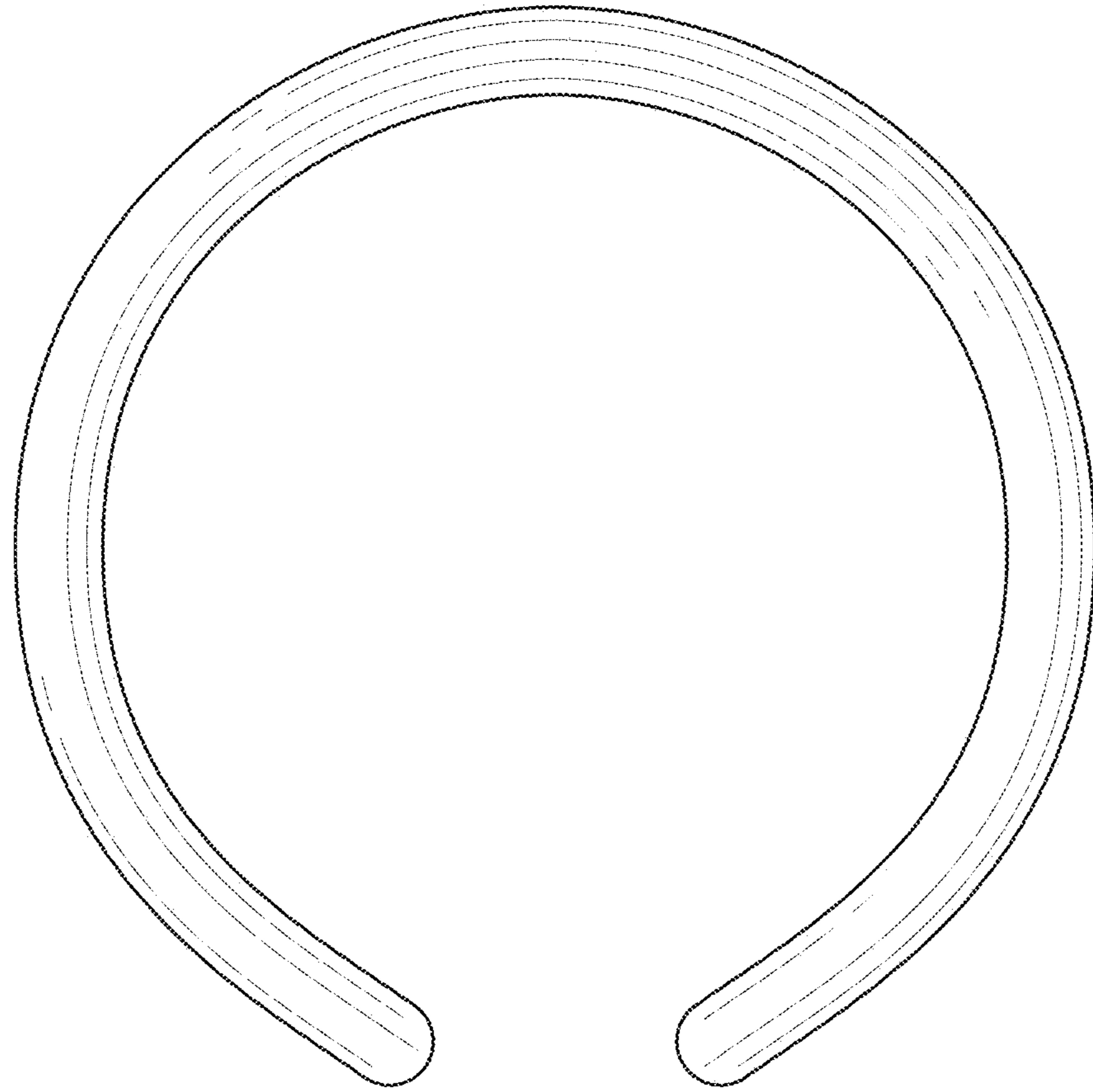

FIG. 16

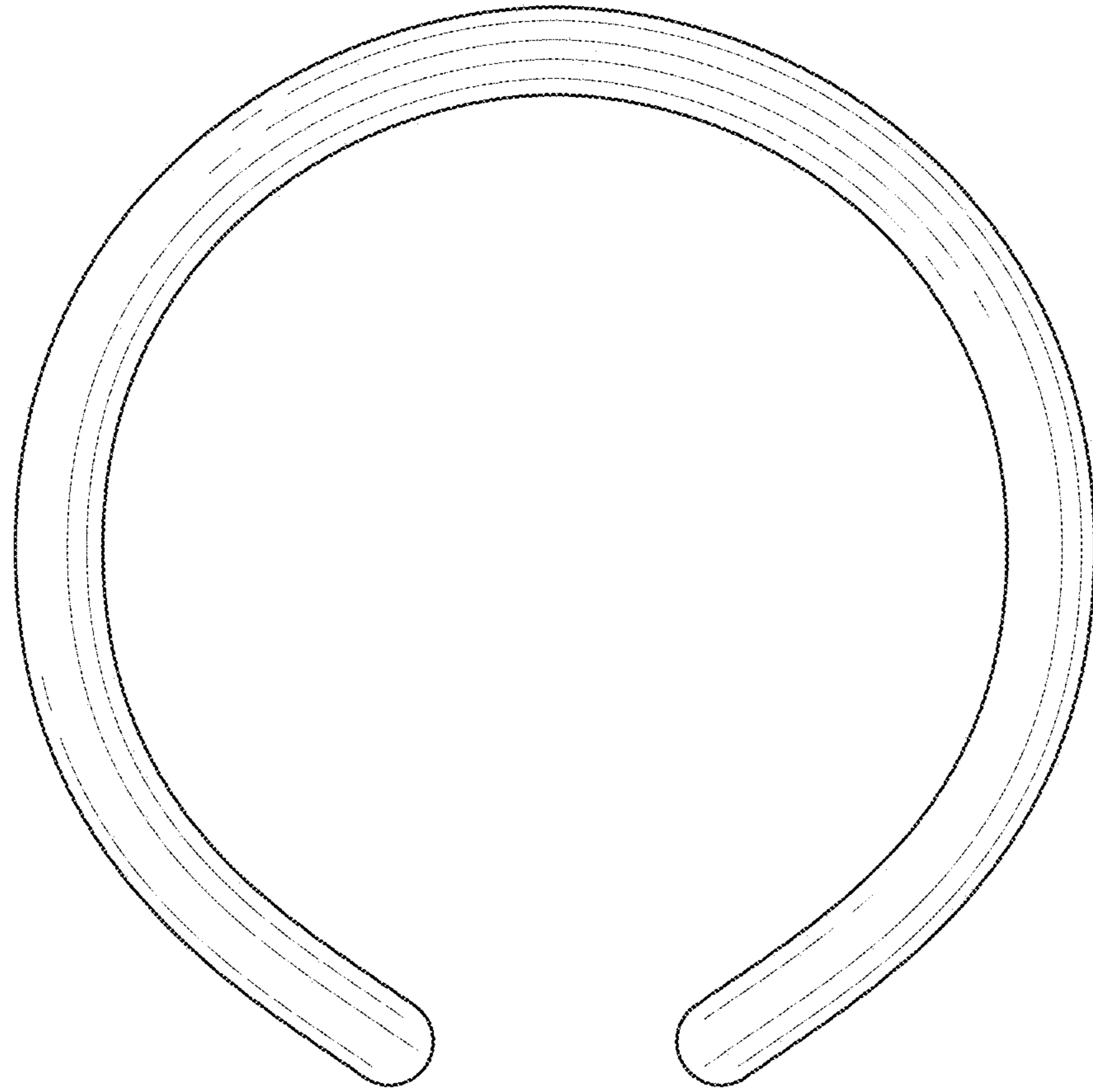

FIG. 17

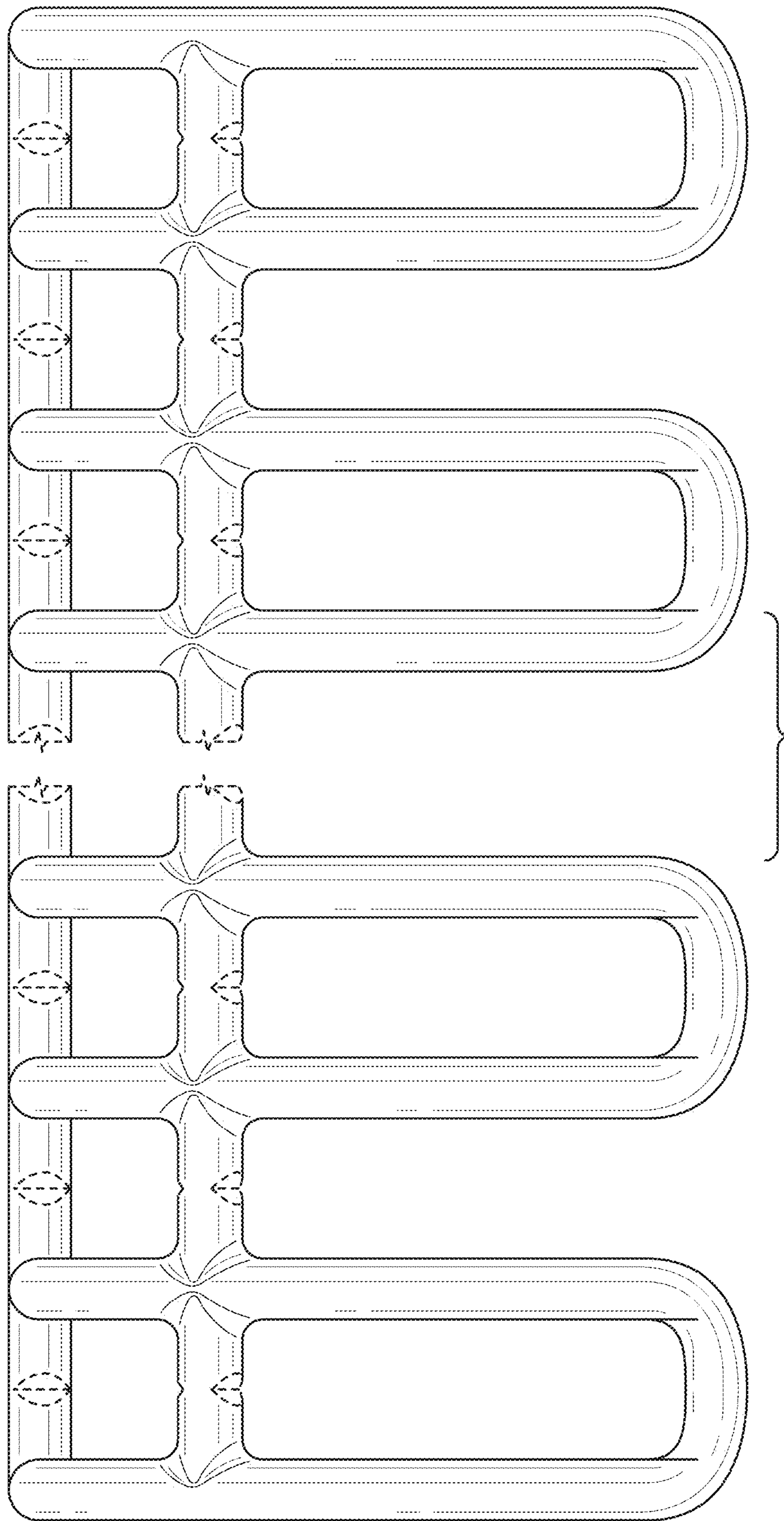

FIG. 18



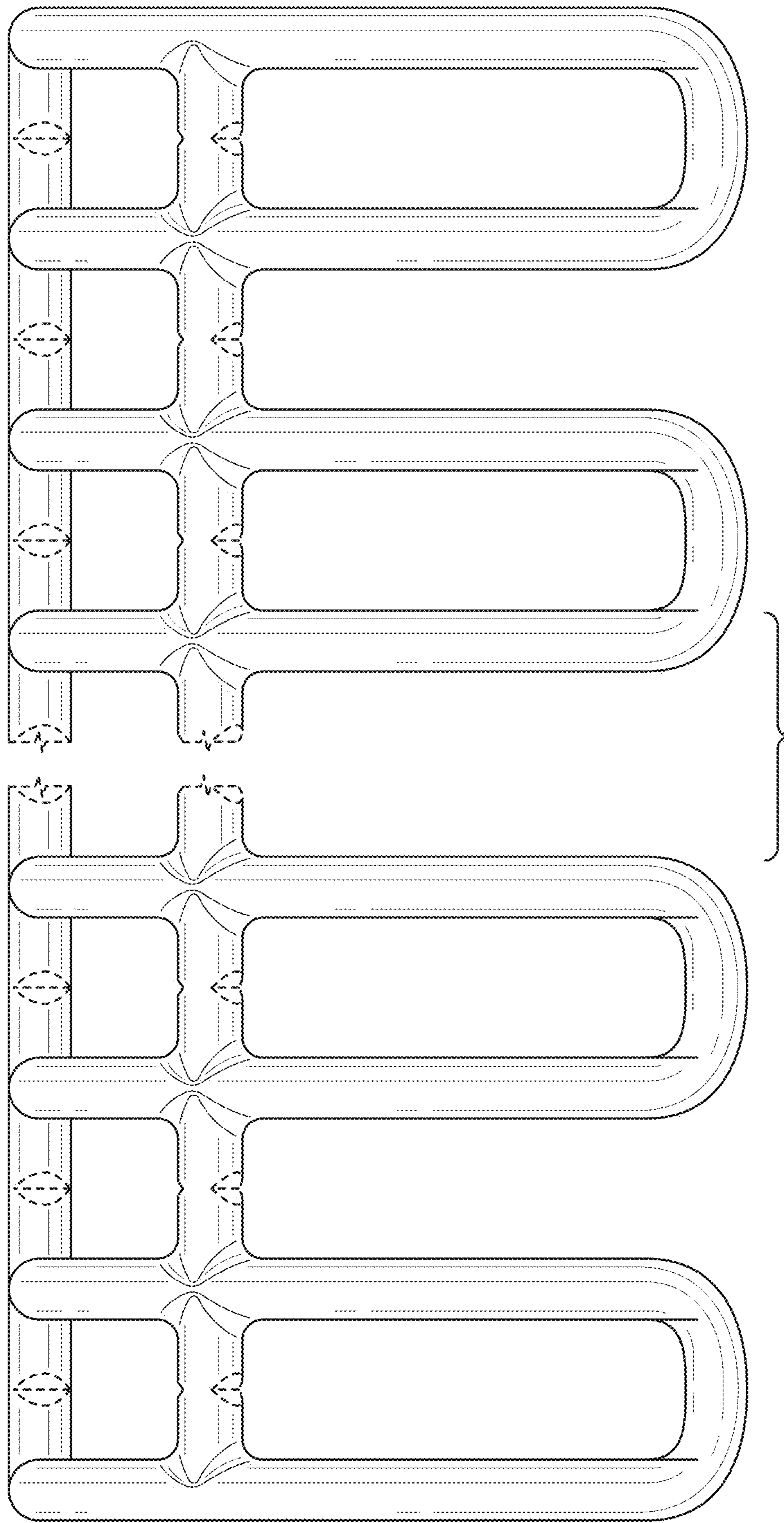

FIG. 19

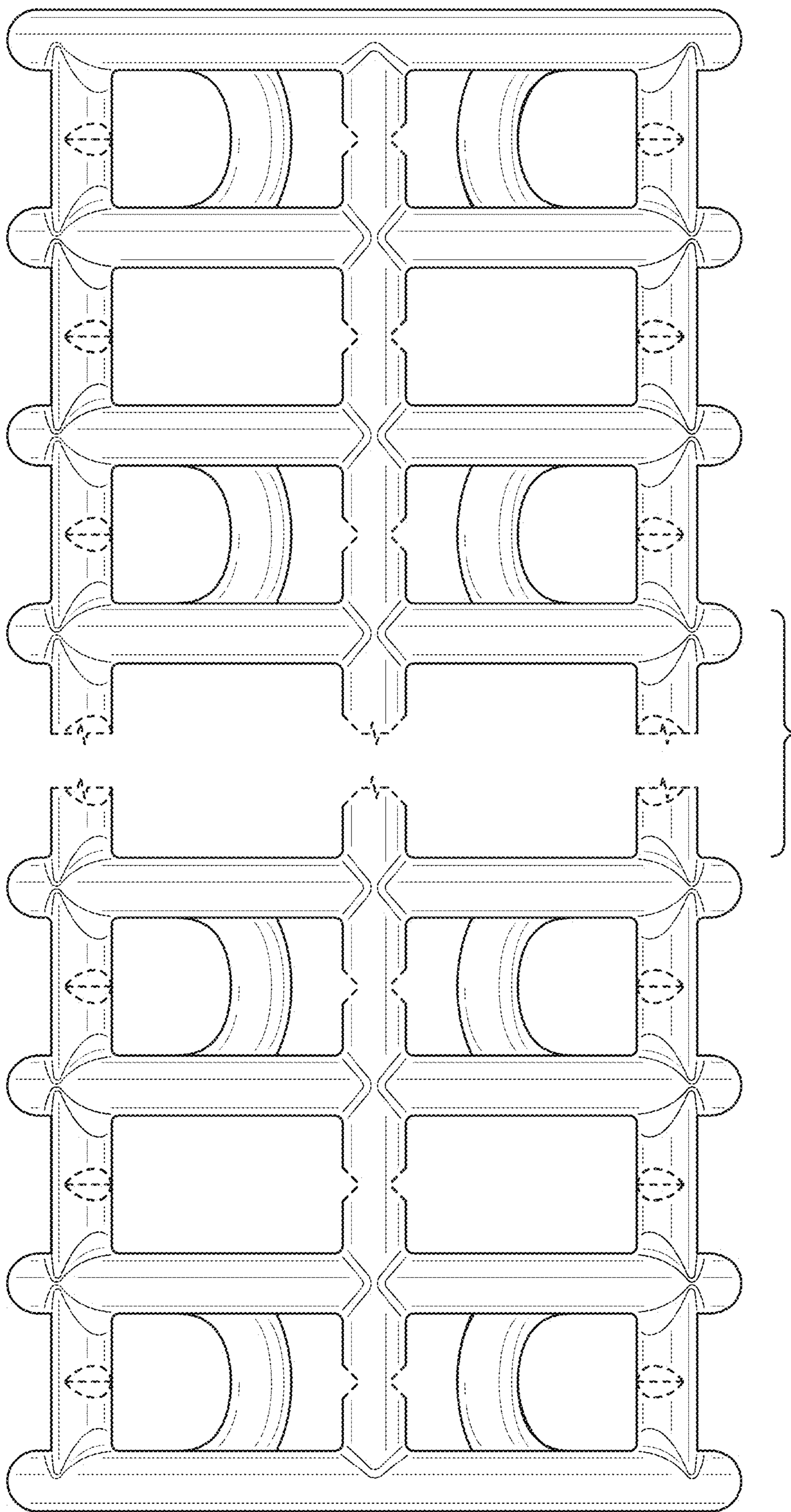

FIG. 20

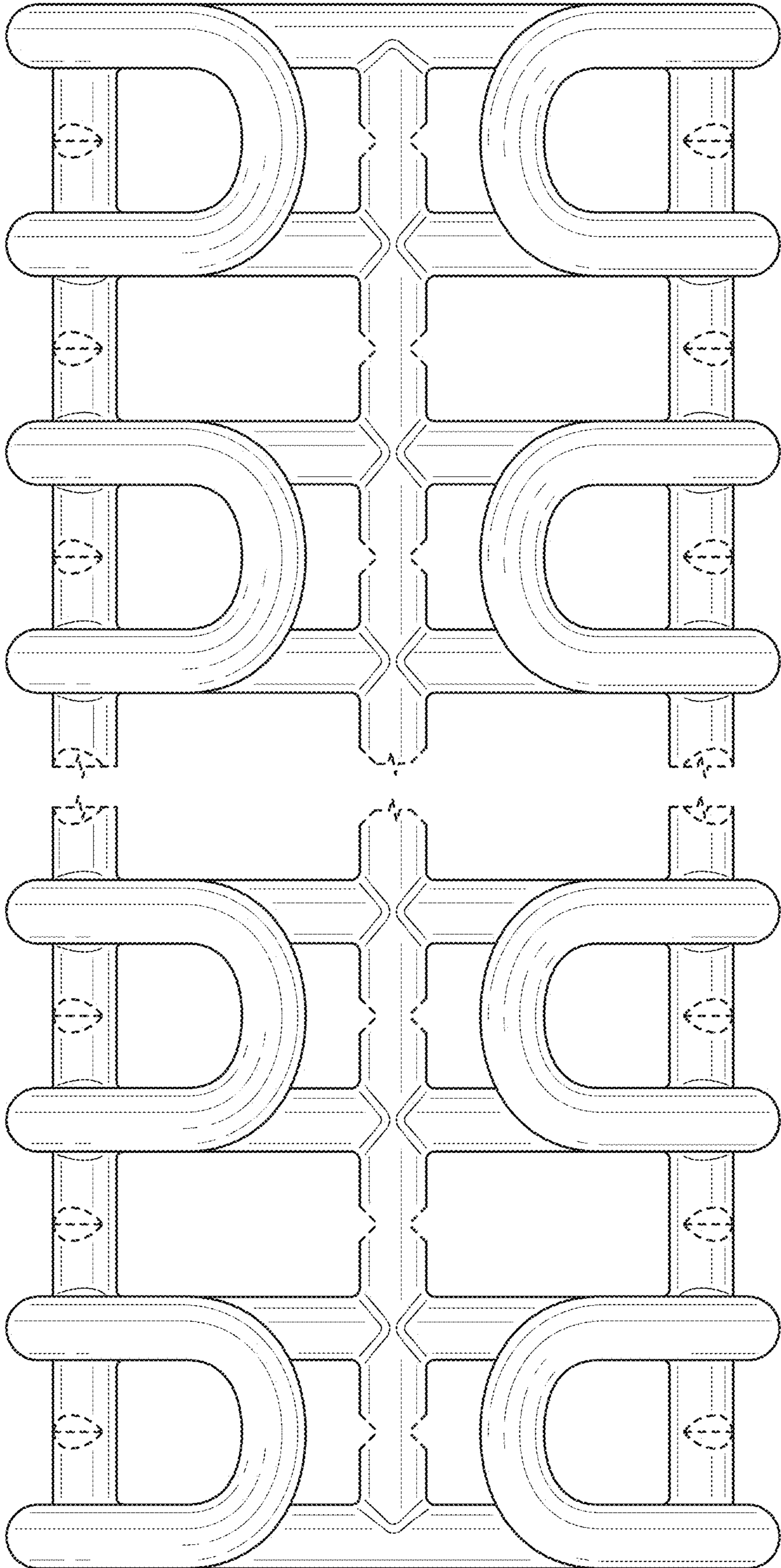

FIG. 21



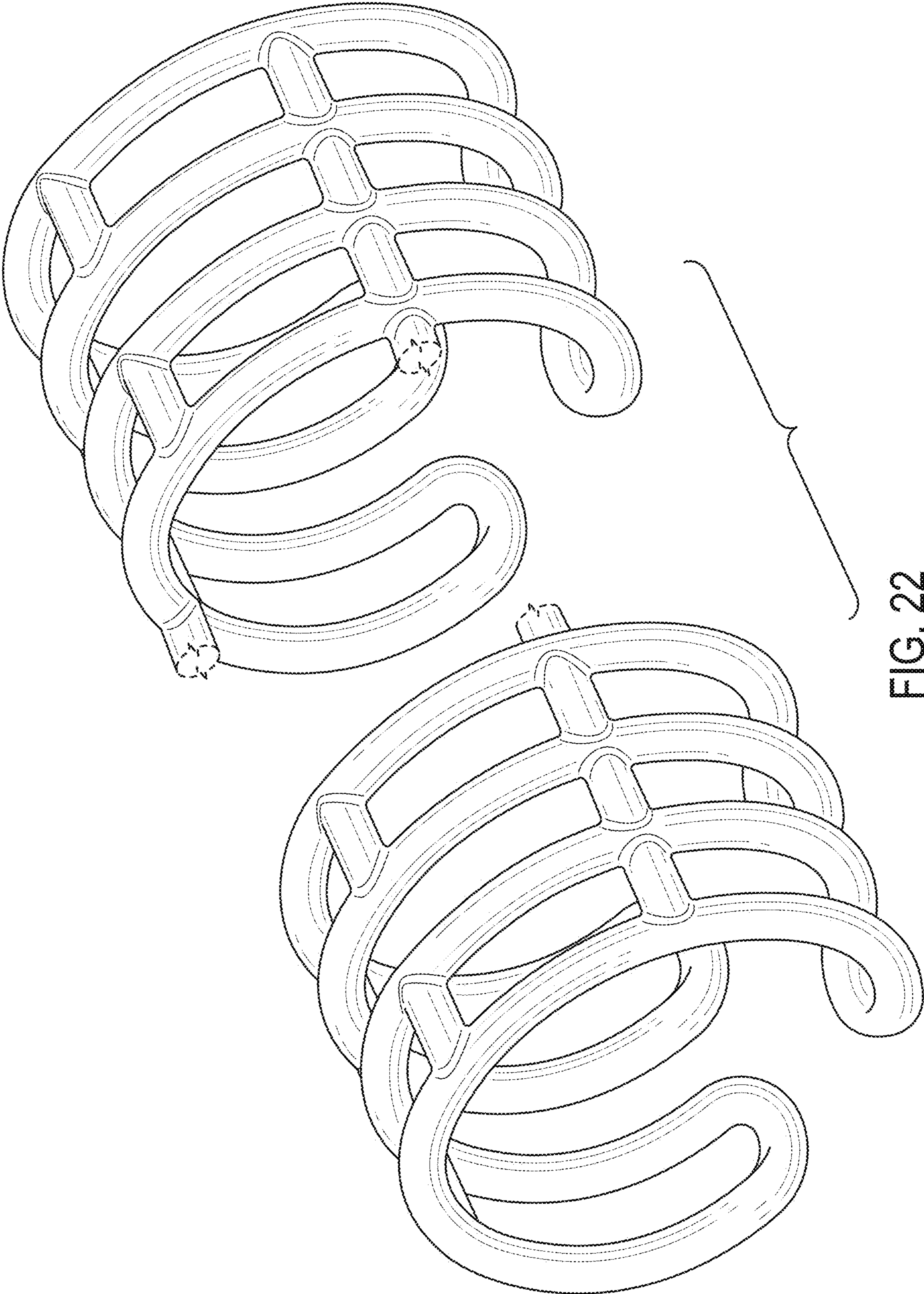

FIG. 22

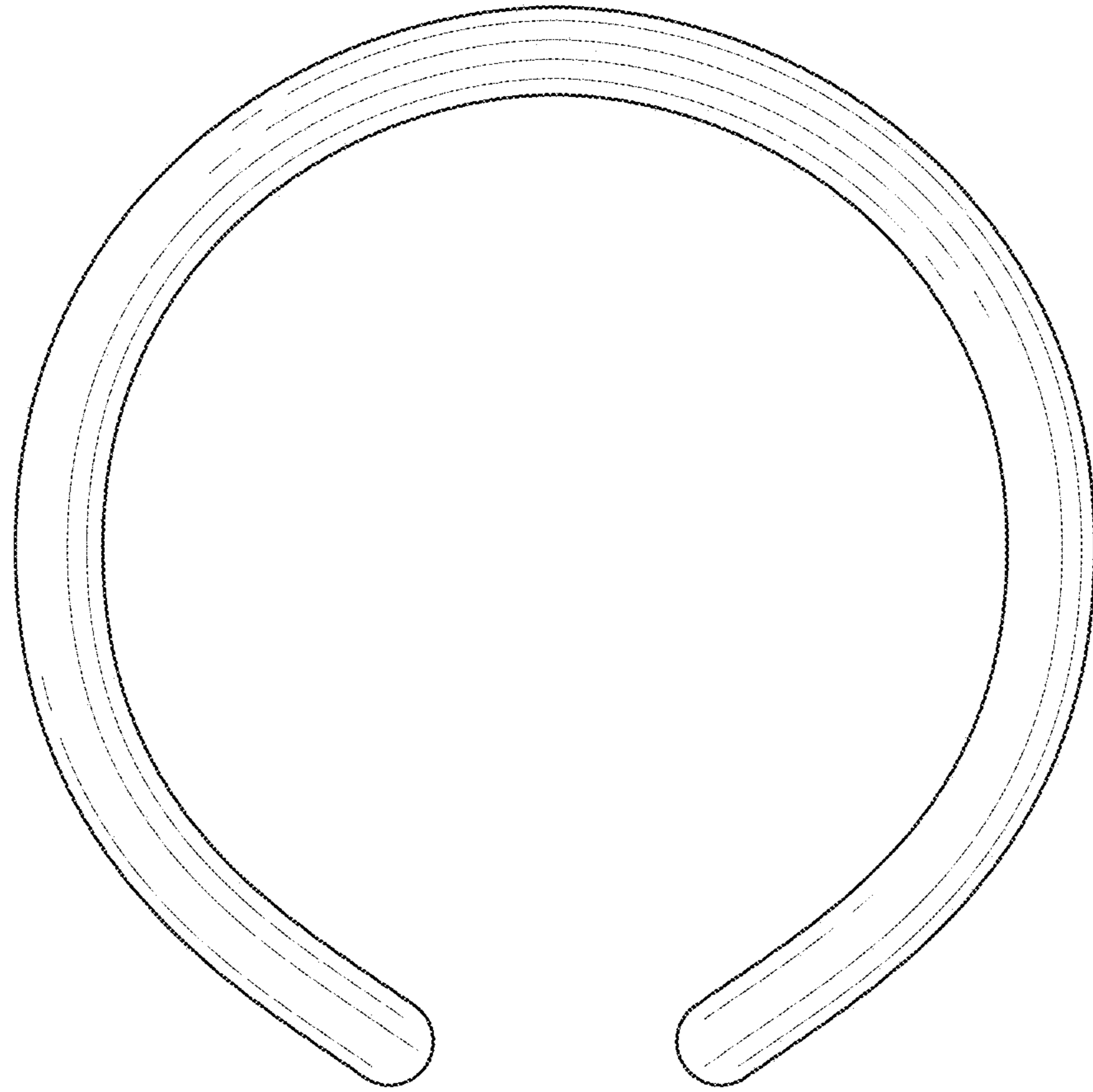

FIG. 23

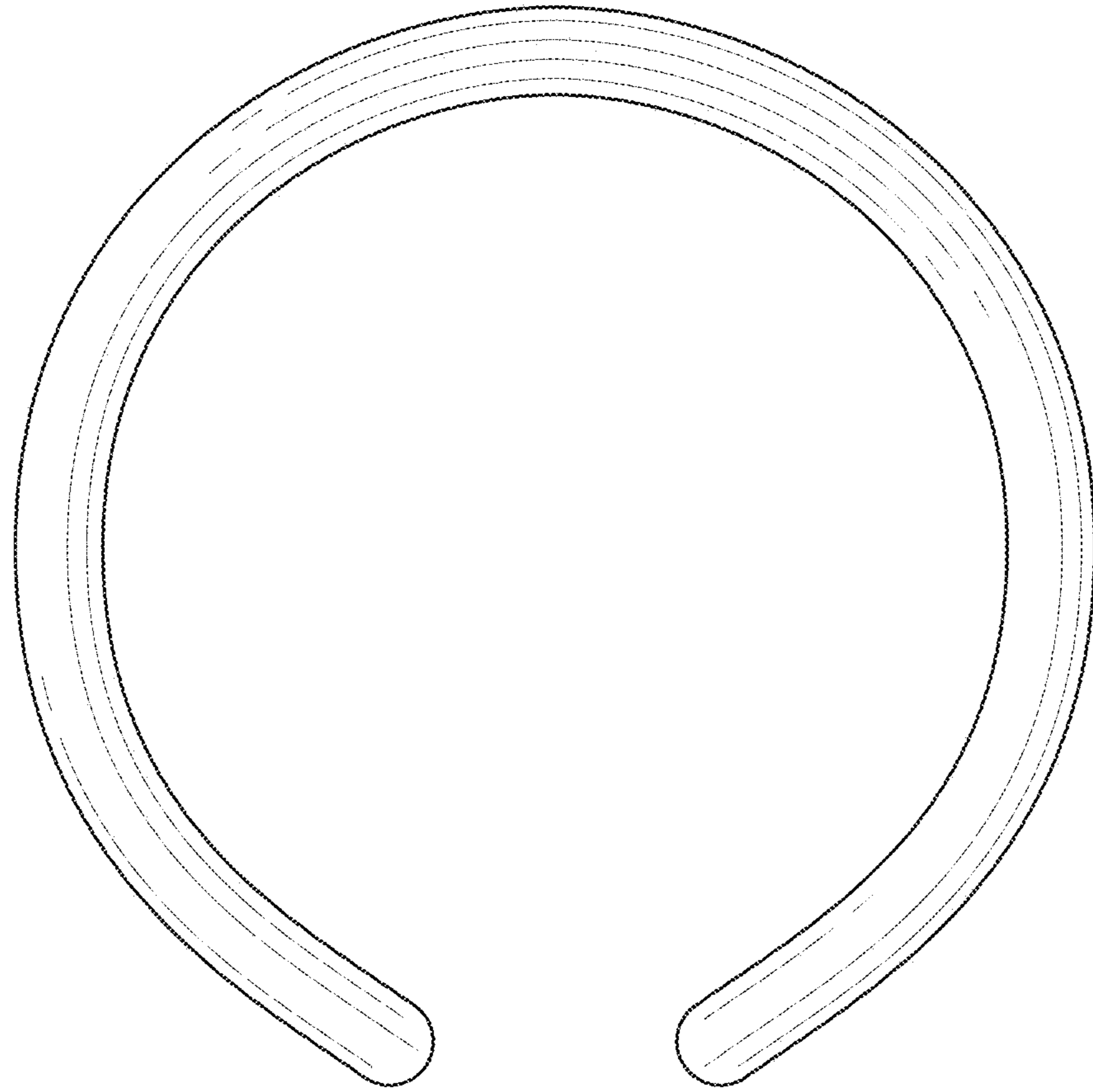

FIG. 24



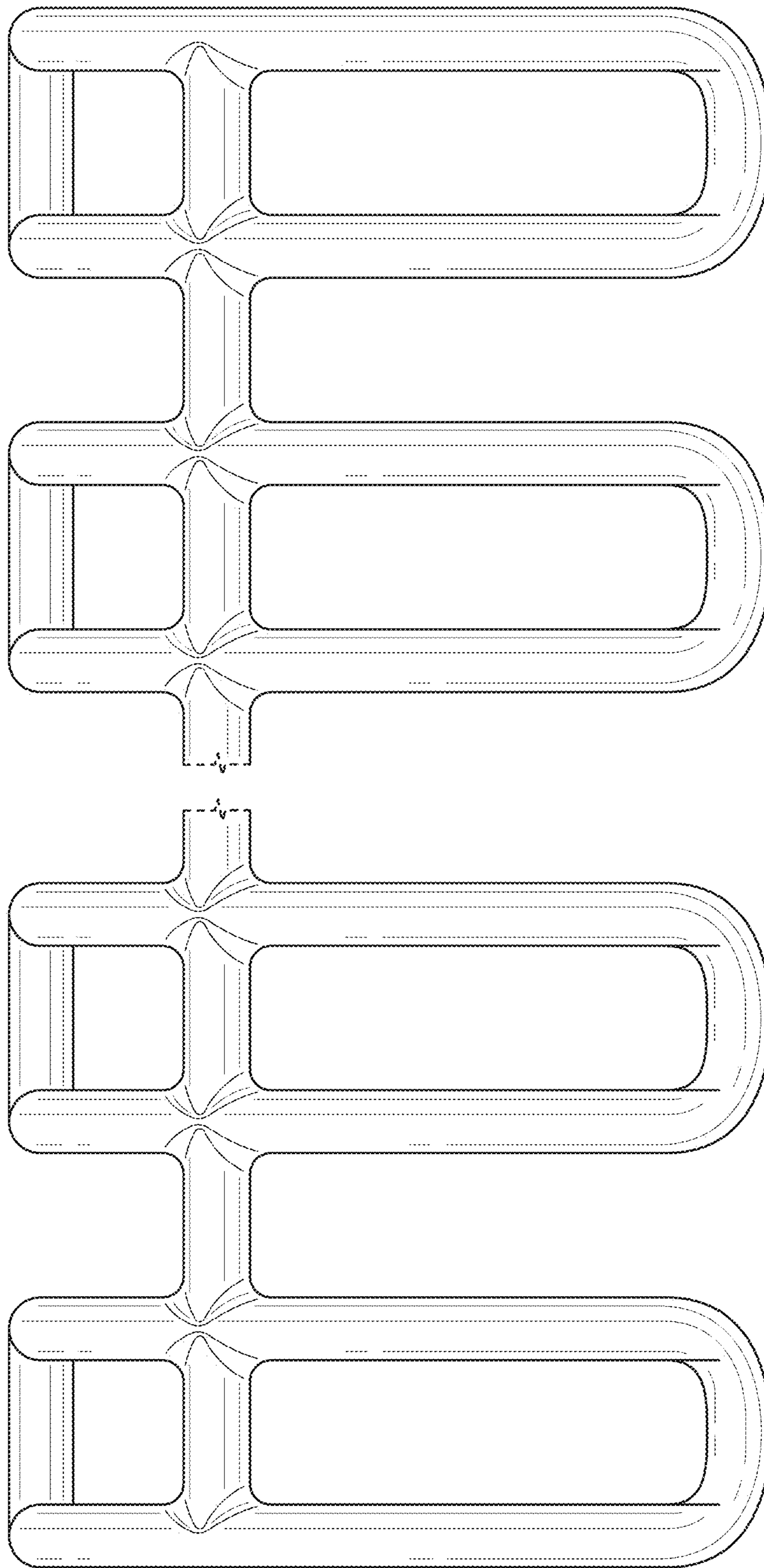

FIG. 25

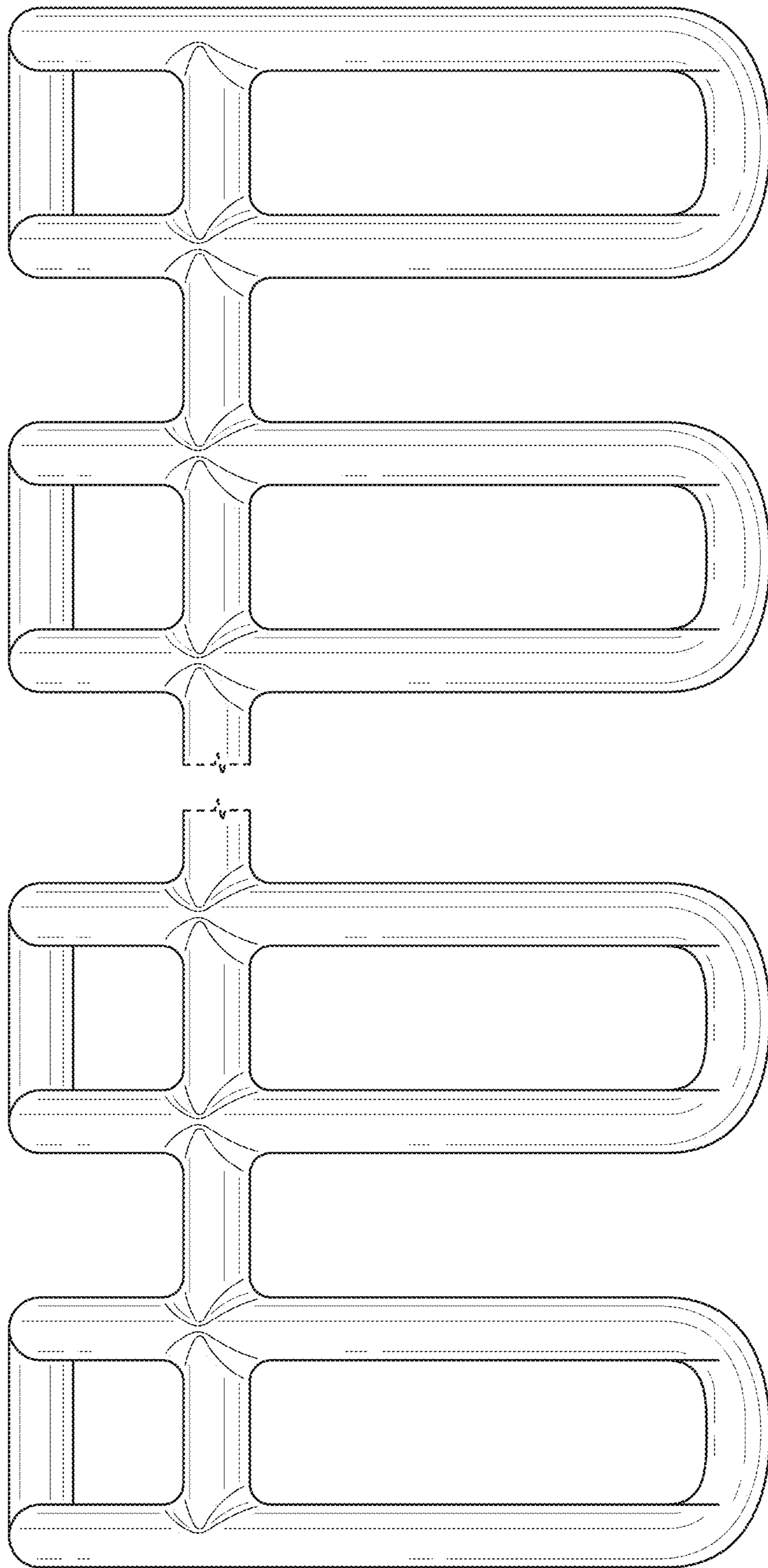

FIG. 26

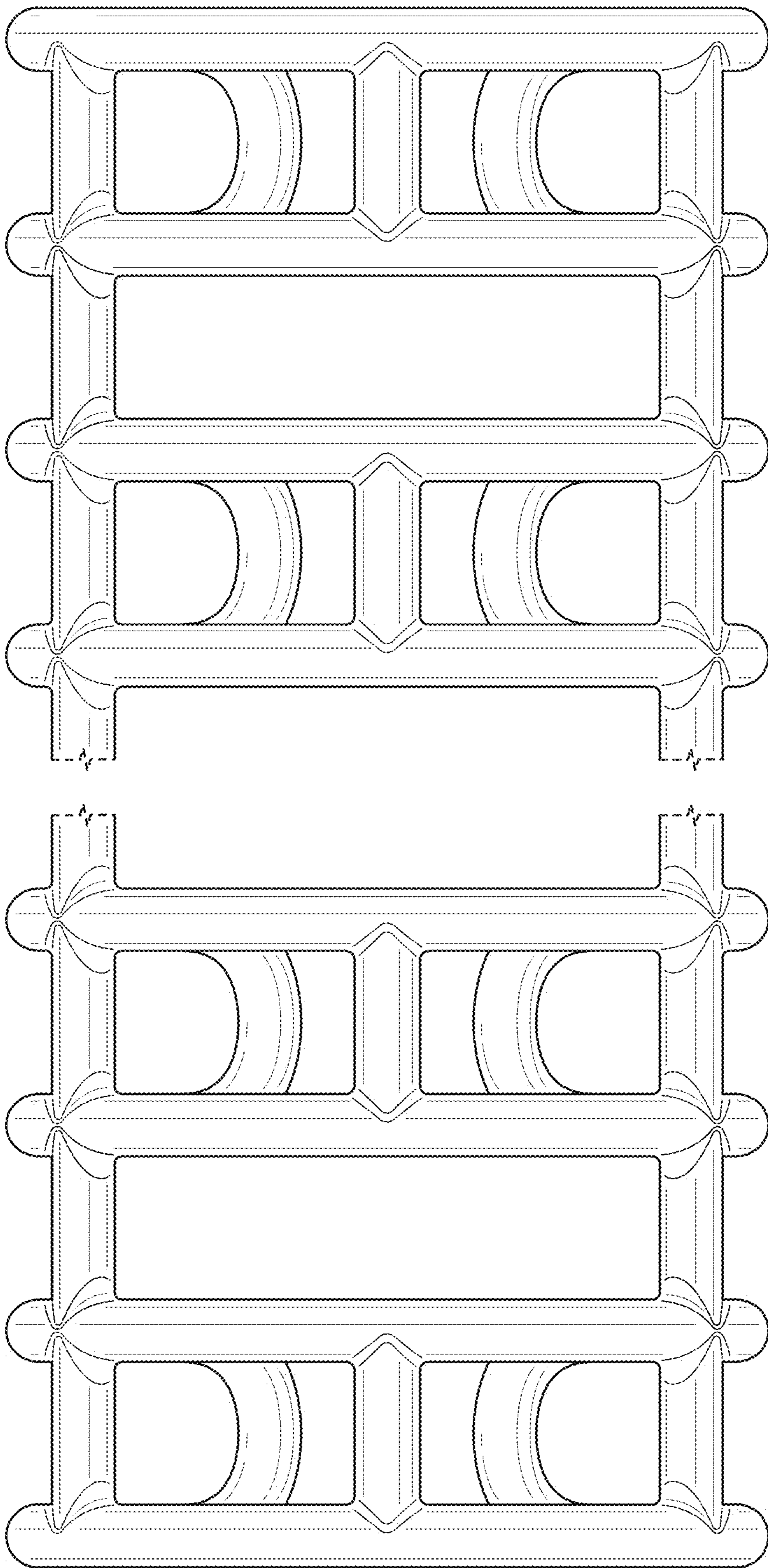

FIG. 27



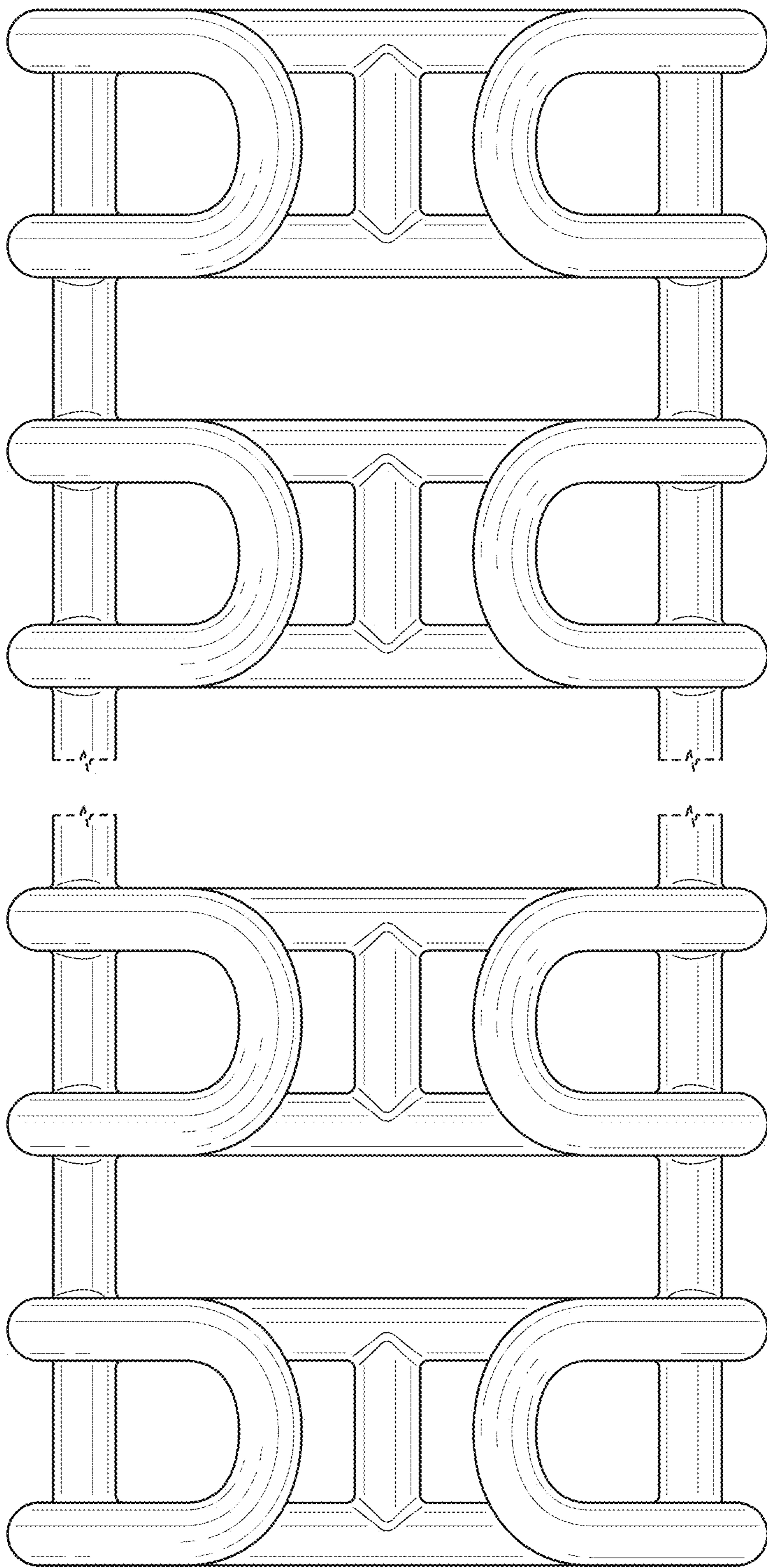

FIG. 28

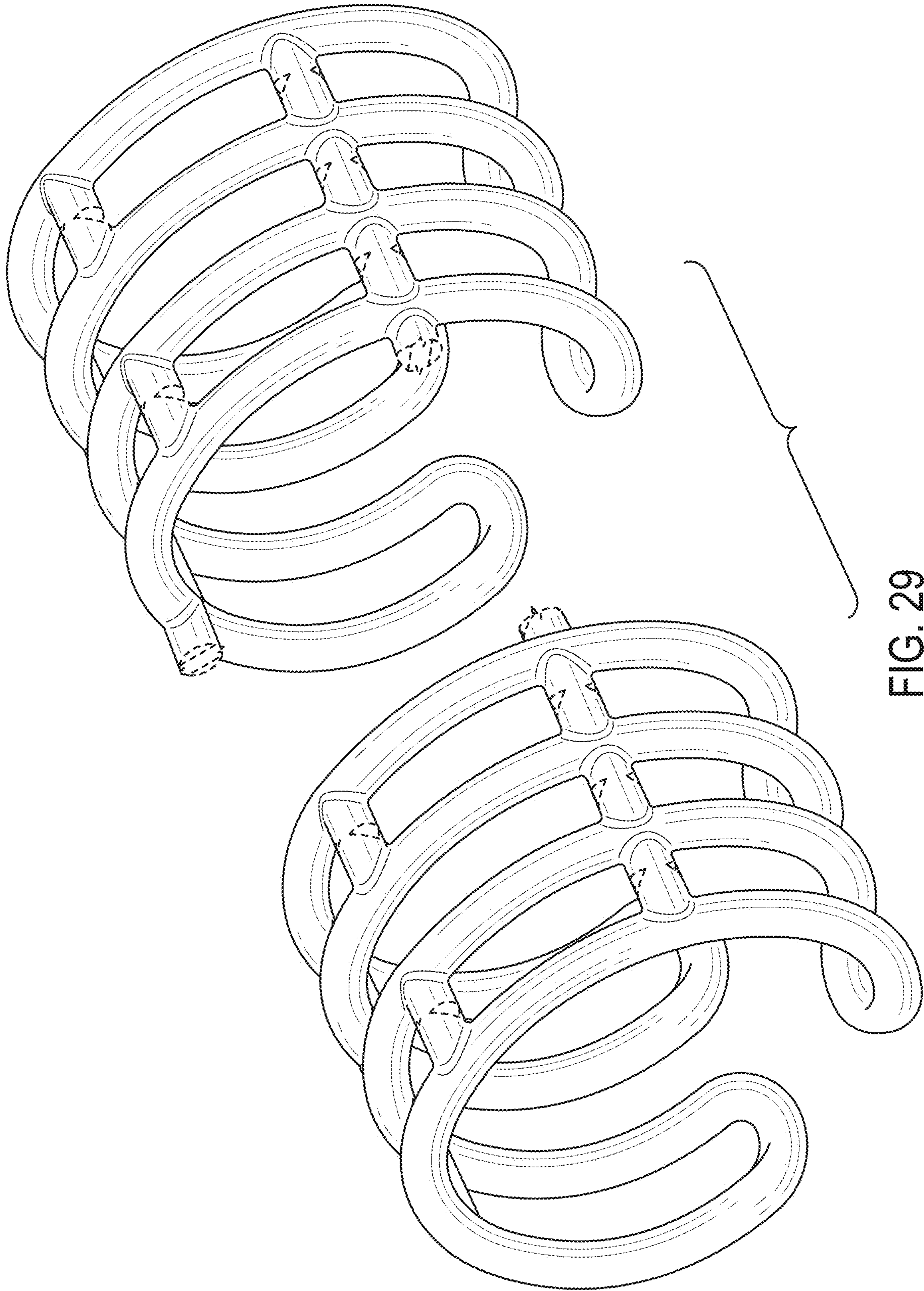

FIG. 29

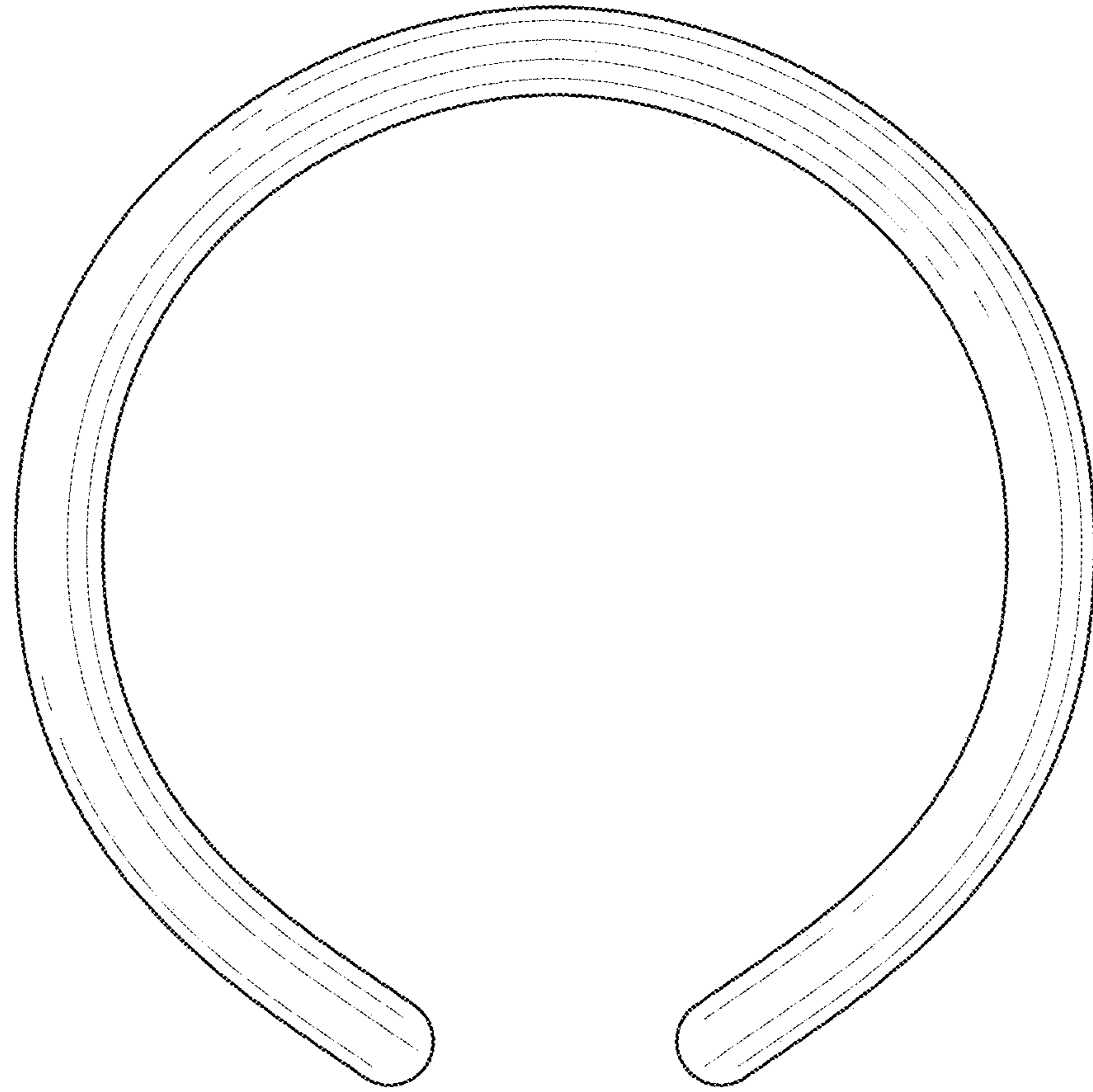

FIG. 30



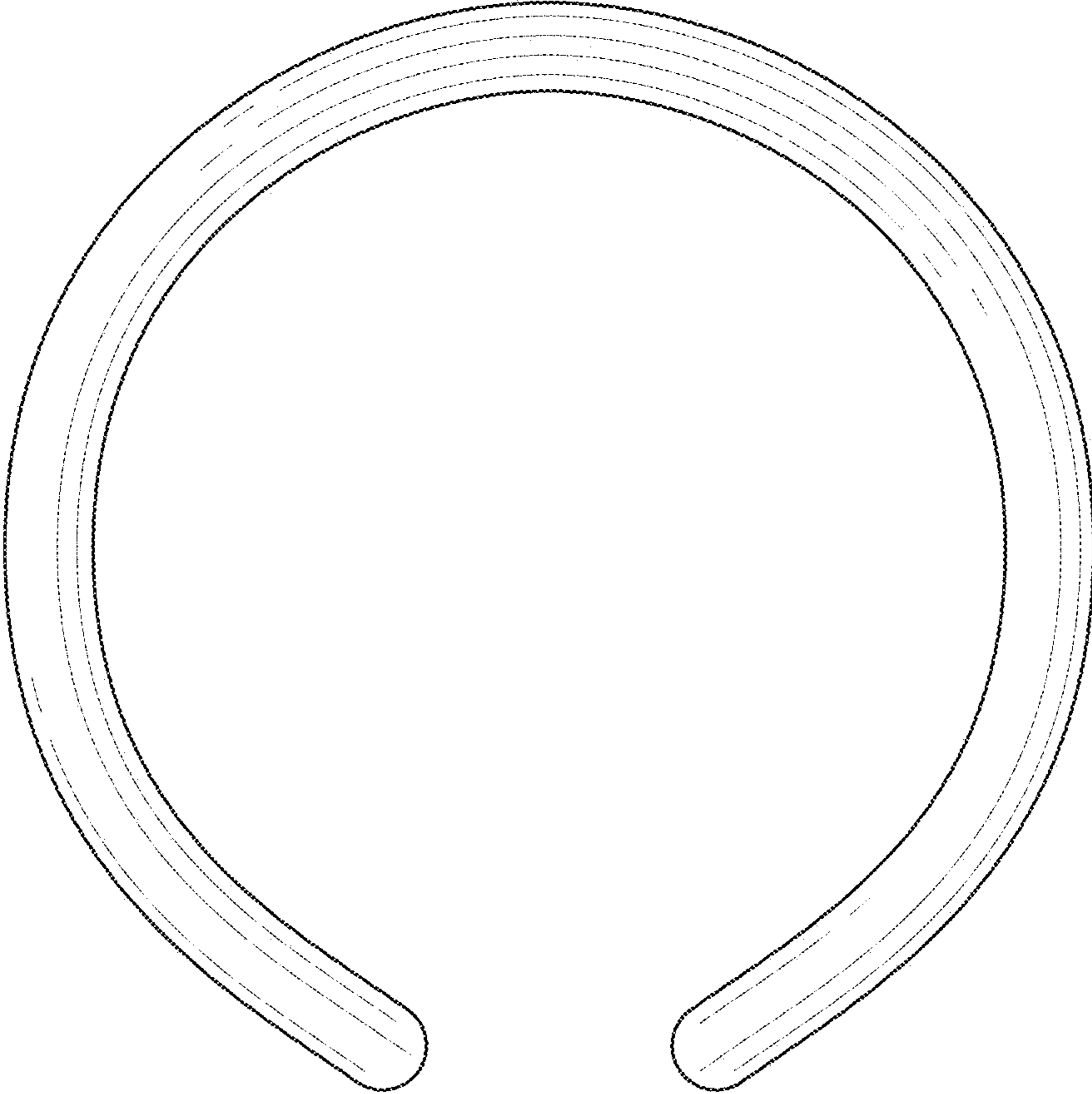

FIG. 31

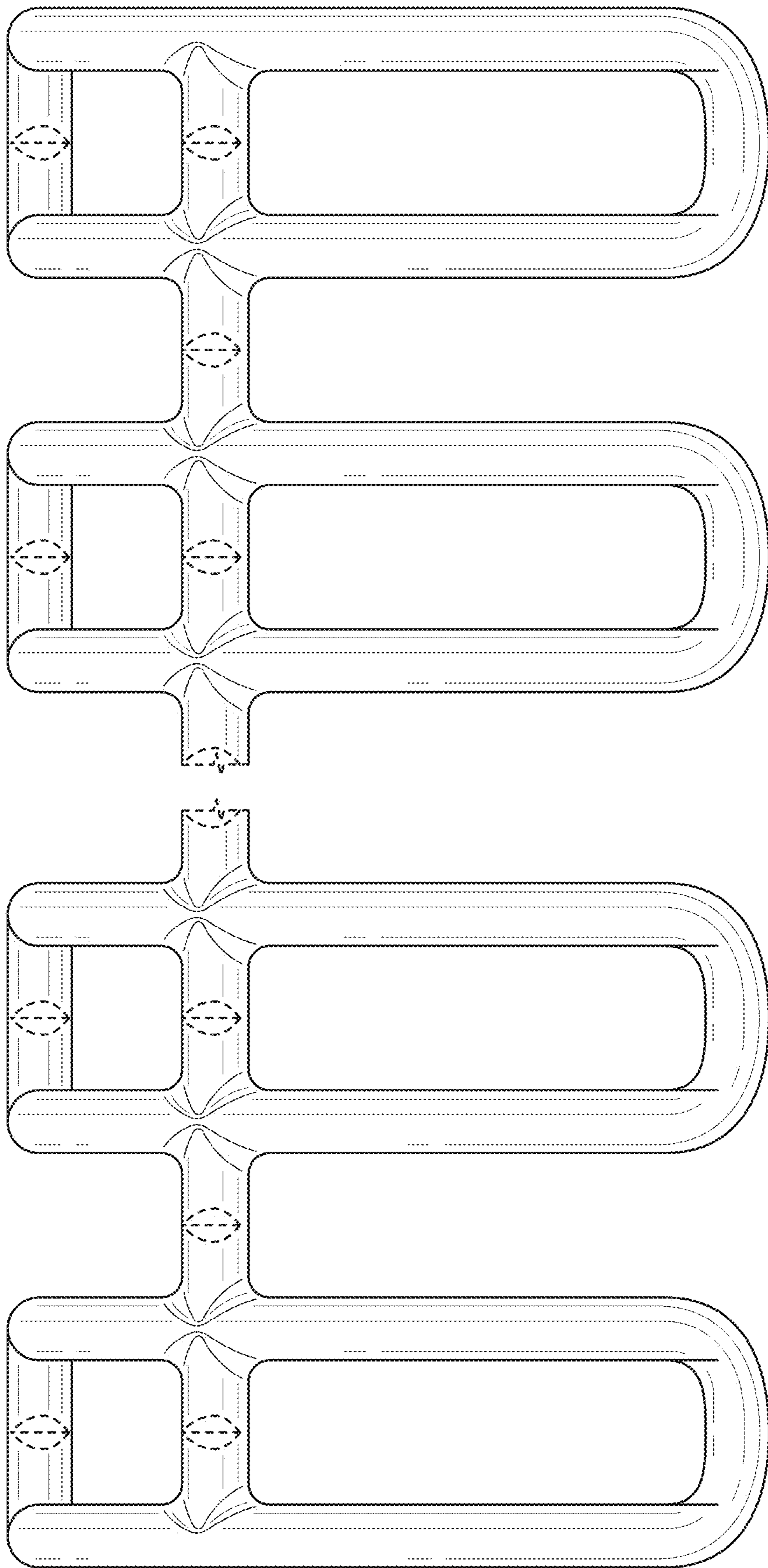

FIG. 32

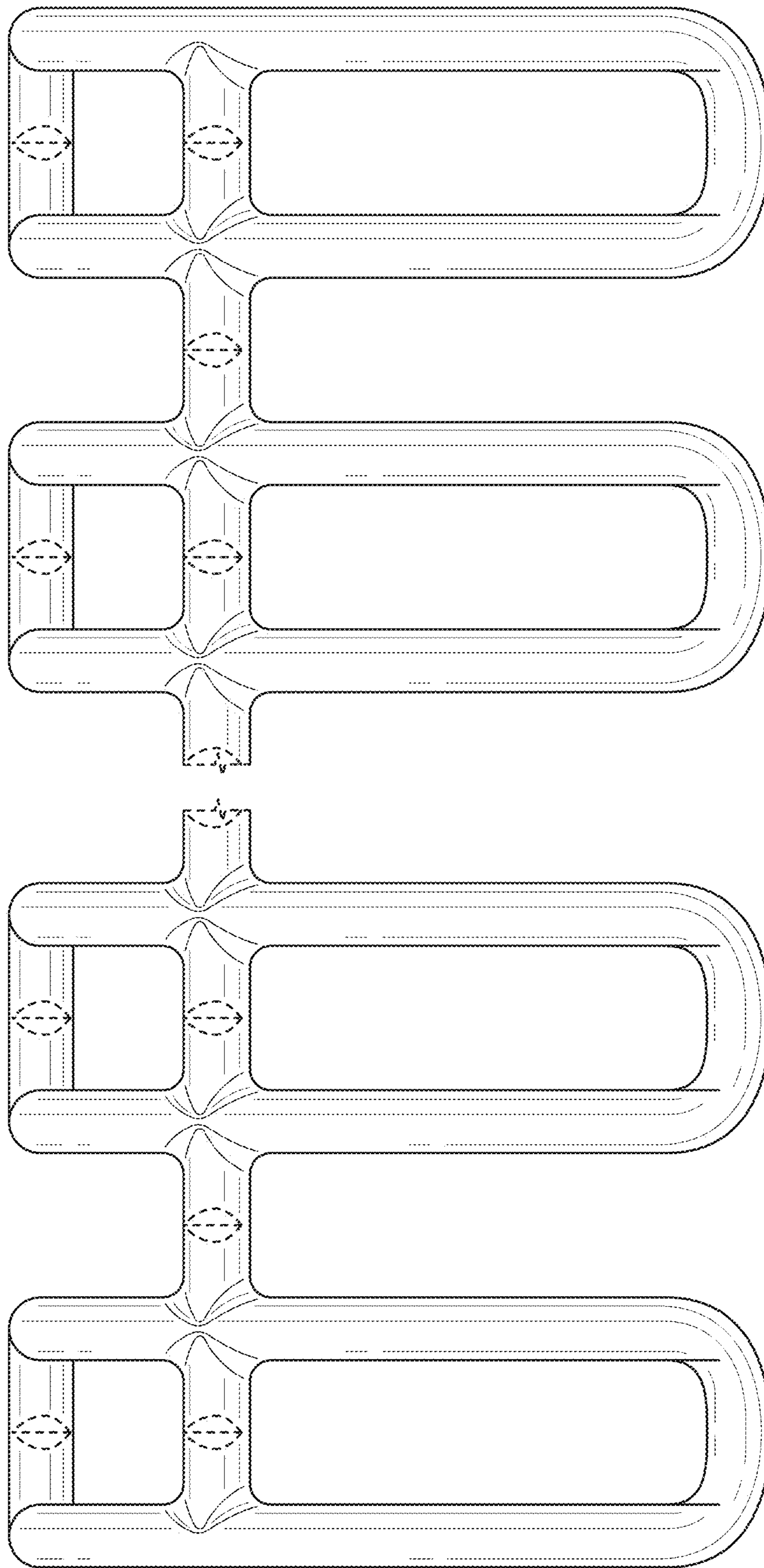

FIG. 33



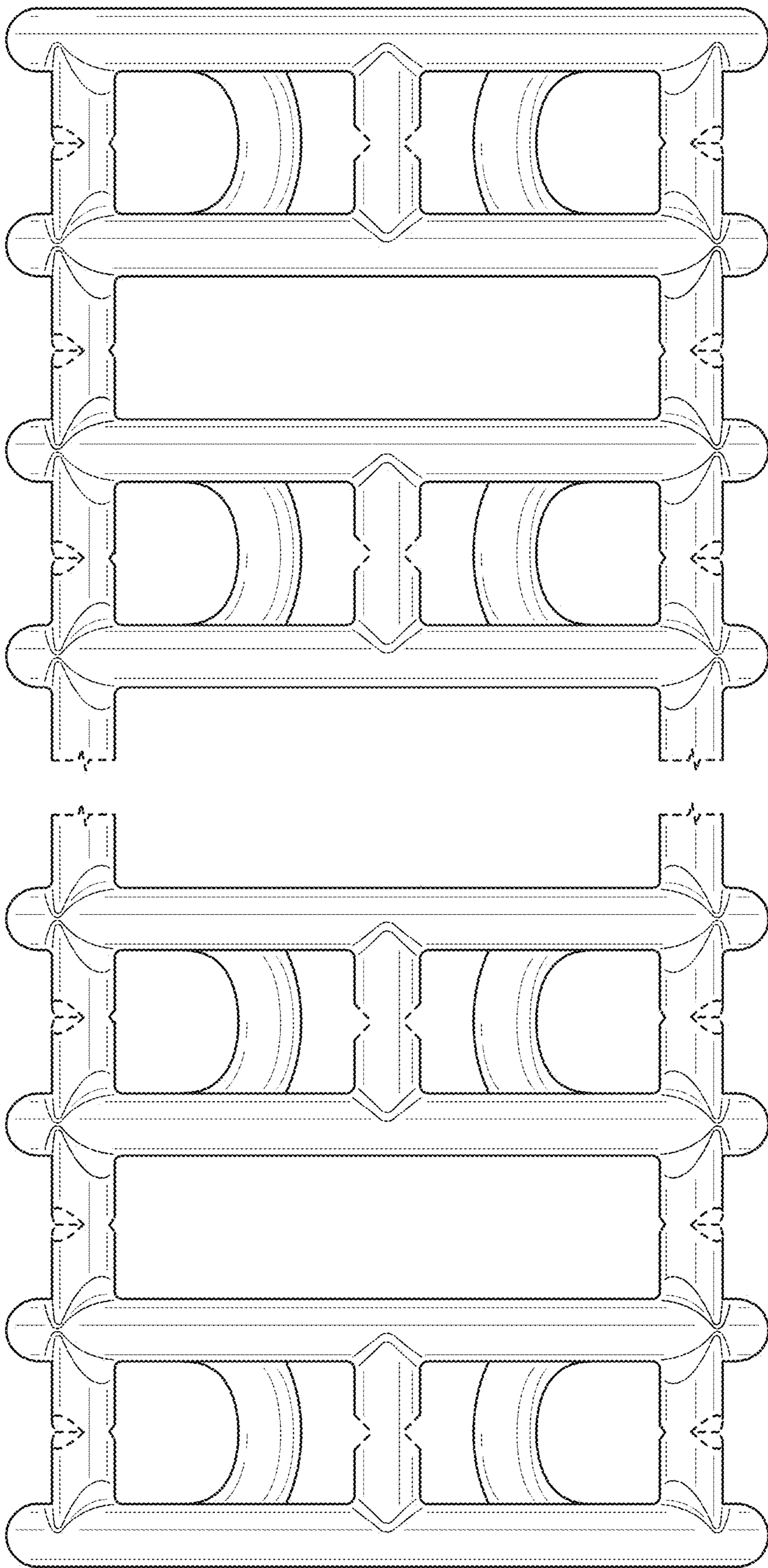

FIG. 34

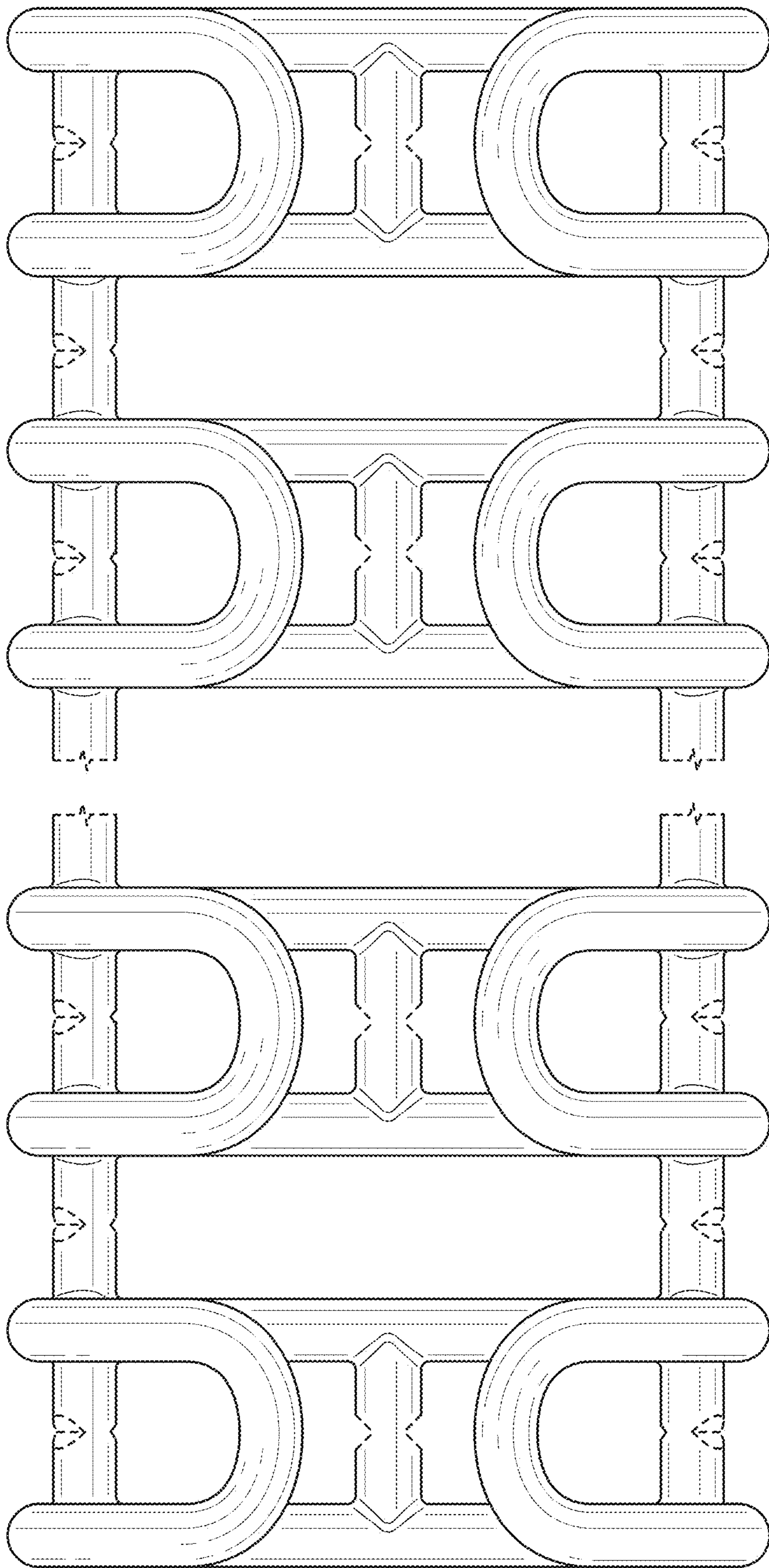

FIG. 35