



US00D950538S

(12) **United States Design Patent**
Dang et al.

(10) **Patent No.:** **US D950,538 S**
(45) **Date of Patent:** **** May 3, 2022**

(54) **CASE FOR A MOBILE ELECTRONIC DEVICE**

(71) Applicant: **mophie inc.**, Irvine, CA (US)

(72) Inventors: **Dat Minh Dang**, Westminster, CA (US); **Nguyen To**, Corona, CA (US); **Chee-Wui Loke**, Irvine, CA (US); **Wendong Sun**, Shenzhen (CN)

(73) Assignee: **mophie inc.**, Irvine, CA (US)

(**) Term: **15 Years**

(21) Appl. No.: **29/682,972**

(22) Filed: **Mar. 8, 2019**

Related U.S. Application Data

(63) Continuation of application No. 29/556,809, filed on Mar. 3, 2016, now abandoned.

(51) **LOC (13) Cl.** **14-03**

(52) **U.S. Cl.**
USPC **D14/250**; D13/108

(58) **Field of Classification Search**
USPC D3/201, 218, 249; D13/103, 107, 108, D13/119; D14/137, 138 R, 138 AA, D14/138 C, 138 G, 172, 192, D14/203.3-203.7, 217, 238.1, 247, 248, D14/250-253, 432, 434, 440, 447
CPC H04B 1/3888; H04M 1/0283; H04M 1/0202; A45C 1/06; A45C 2011/002; A45C 11/00; A45F 2005/028; A45F 2200/0525

See application file for complete search history.

(56) **References Cited**

U.S. PATENT DOCUMENTS

3,851,126 A * 11/1974 Keller F21V 23/04 200/60
4,028,515 A * 6/1977 Desio H01H 1/242 200/31
D267,795 S * 2/1983 Mallon D13/11

4,479,596 A * 10/1984 Swanson A45C 11/00 224/23
4,515,272 A * 5/1985 Newhouse B65D 81/022 206/59
D284,372 S * 6/1986 Carpenter 379/45
4,951,817 A * 8/1990 Barletta A45F 5/02 206/30
D312,534 S * 12/1990 Nelson D10/80
5,001,772 A * 3/1991 Holcomb H04B 1/3883 320/11
D322,719 S * 12/1991 Jayez D3/218
D327,868 S * 7/1992 Oka D13/11
5,360,108 A * 11/1994 Alagia H01H 9/0242 206/32
5,368,159 A * 11/1994 Doria H01H 9/0242 206/32
5,383,091 A * 1/1995 Snell H01H 13/70 150/15
5,386,084 A * 1/1995 Risko H01H 13/70 174/56
5,508,123 A * 4/1996 Fan H01M 2/1055 429/10
D372,896 S * 8/1996 Nagele D13/10
5,586,002 A * 12/1996 Notarianni G06F 1/1626 248/92
5,604,050 A * 2/1997 Brunette H01M 2/1022 254/2 R
5,610,979 A * 3/1997 Yu A45F 5/02 379/42
D384,327 S * 9/1997 Nakui D13/10
5,708,707 A * 1/1998 Halttunen B60R 11/0241 379/44
5,711,013 A * 1/1998 Collett H04B 1/3827 455/34
D392,248 S * 3/1998 Johansson D13/10
D392,939 S * 3/1998 Finke-Anlauff D13/10
5,786,106 A * 7/1998 Armani H01M 2/1022 429/10
5,816,459 A * 10/1998 Armistead A45F 5/02 224/24
D400,495 S * 11/1998 Deslyper D13/10
D400,496 S * 11/1998 Barber D13/10
5,859,481 A * 1/1999 Banyas H02J 7/0024 307/13
5,864,766 A * 1/1999 Chiang H04M 1/0262 379/42
D405,801 S * 2/1999 Nagele D14/25
D407,063 S * 3/1999 Reis, Jr. D13/10
5,876,351 A * 3/1999 Rohde A61B 5/0404 600/50
D407,708 S * 4/1999 Nagele D13/10

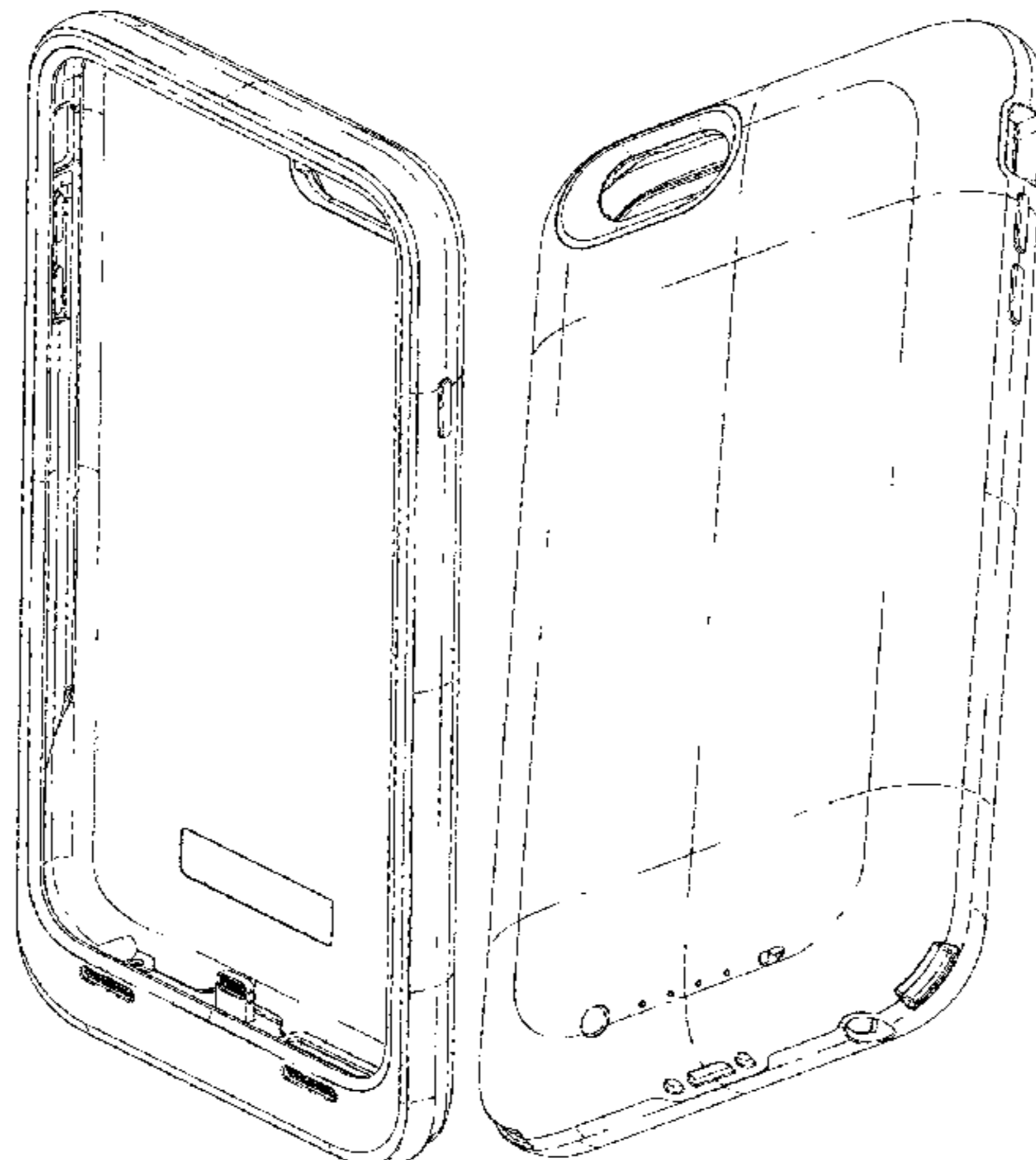

US D950,538 S

5,896,277 A *	4/1999	Leon	H01M 2/1022 361/81	6,626,362 B1 *	9/2003	Steiner	G06K 7/10881 235/46
5,932,855 A *	8/1999	Wang	G06F 1/1626 200/50	D481,716 S *	11/2003	He	D13/11
5,959,433 A *	9/1999	Rohde	H02J 50/10 320/10	D482,529 S *	11/2003	Hardigg	D3/276
5,973,477 A *	10/1999	Chang	H01M 10/425 320/11	6,646,864 B2 *	11/2003	Richardson	G06F 1/1626 206/30
D417,189 S *	11/1999	Amero, Jr.	D13/10	D484,874 S *	1/2004	Chang	D14/25
6,043,626 A *	3/2000	Snyder	A45F 5/02 320/10	D485,834 S *	1/2004	Davetas	D14/25
D424,512 S *	5/2000	Ho	D13/10	6,681,003 B2 *	1/2004	Linder	A61B 5/0006 379/10
6,069,332 A *	5/2000	Suchanek	H01H 9/02 200/29	6,701,159 B1 *	3/2004	Powell	A45C 11/00 379/44
6,081,595 A *	6/2000	Picaud	H04B 1/3888 379/44	6,708,887 B1 *	3/2004	Garrett	G06F 1/1626 235/46
D428,019 S *	7/2000	Amron	D14/20	6,714,802 B1 *	3/2004	Barvesten	H04M 1/0254 455/55
6,082,535 A *	7/2000	Mitchell	A45C 11/00 150/15	6,785,566 B1 *	8/2004	Irizarry	H04B 1/3888 455/57
6,171,138 B1 *	1/2001	Lefebvre	H04M 1/0262 429/97	6,819,549 B1 *	11/2004	Lammers-Meis	G06F 1/1626 361/67
D438,004 S *	2/2001	Watson	D3/273	D500,041 S *	12/2004	Tsujimoto	D14/43
6,184,654 B1 *	2/2001	Bachner, III	H02J 7/0042 320/11	D506,612 S *	6/2005	Rosa	D14/21
D439,218 S *	3/2001	Yu	D13/10	D508,495 S *	8/2005	Bone	D14/20
6,201,867 B1 *	3/2001	Koike	H04M 1/0283 379/43	D513,123 S *	12/2005	Richardson	D3/273
6,208,115 B1 *	3/2001	Binder	H02J 7/022 307/66	6,980,777 B2 *	12/2005	Shepherd	H04B 1/3888 379/43
6,266,539 B1 *	7/2001	Pardo	G06F 1/1632 379/93	D513,451 S *	1/2006	Richardson	D3/273
D446,497 S *	8/2001	Yu	D13/10	6,992,461 B2 *	1/2006	Liang	H02J 7/0047 320/10
6,273,252 B1 *	8/2001	Mitchell	A45C 11/00 206/32	D514,808 S *	2/2006	Morine	D3/273
D447,462 S *	9/2001	Kosiba	D13/10	D516,309 S *	3/2006	Richardson	D3/273
6,313,982 B1 *	11/2001	Hino	A45C 13/002 206/32	D516,553 S *	3/2006	Richardson	D14/34
6,317,313 B1 *	11/2001	Mosgrove	G07C 9/00944 345/16	D516,554 S *	3/2006	Richardson	D14/34
6,324,380 B1 *	11/2001	Kiuchi	H01Q 1/243 455/12	D516,807 S *	3/2006	Richardson	D3/273
6,346,791 B1 *	2/2002	Barguirdjian	H02J 7/32 320/10	D517,007 S *	3/2006	Yong-Jian	D13/10
6,377,811 B1 *	4/2002	Sood	H04M 1/72502 455/45	D520,744 S *	5/2006	Pangerc	D3/273
6,405,056 B1 *	6/2002	Altschul	H04M 1/0235 455/40	7,050,841 B1 *	5/2006	Onda	A45F 5/02 455/55
D460,411 S *	7/2002	Wang	D13/10	7,069,063 B2 *	6/2006	Halkosaari	H04M 1/0283 200/30
D460,761 S *	7/2002	Croley	D14/43	D525,582 S *	7/2006	Chan	D13/10
6,415,138 B2 *	7/2002	Sirola	G06F 1/1626 345/17	7,072,699 B2 *	7/2006	Eiden	H04M 1/0237 361/61
6,434,371 B1 *	8/2002	Claxton	H04M 1/0214 379/43	7,079,879 B1 *	7/2006	Sylvester	H04M 1/17 455/57
6,434,404 B1 *	8/2002	Claxton	H04M 1/0214 455/57	7,081,736 B2 *	7/2006	Seil	H01M 2/1055 320/11
6,445,577 B1 *	9/2002	Madsen	G06F 1/1628 206/32	D526,780 S *	8/2006	Richardson	D3/218
6,471,056 B1 *	10/2002	Tzeng	A45C 11/00 150/15	D526,958 S *	8/2006	Shimizu	D13/10
D469,427 S *	1/2003	Ma	D14/25	D530,079 S *	10/2006	Thomas	D14/20
6,536,589 B2 *	3/2003	Chang	G06F 1/1626 206/30	D535,252 S *	1/2007	Sandnes	D13/10
6,538,413 B1 *	3/2003	Beard	G06F 12/1408 307/11	7,158,376 B2 *	1/2007	Richardson	G06F 1/1626 361/67
D472,384 S *	4/2003	Richardson	D3/273	7,166,987 B2 *	1/2007	Lee	A45F 5/00 320/11
6,552,513 B1 *	4/2003	Li	B60R 11/0241 320/10	D537,063 S *	2/2007	Kim	D14/13
6,555,990 B1 *	4/2003	Yang	H02J 7/0042 320/11	7,180,735 B2 *	2/2007	Thomas	G06F 1/1626 206/70
6,583,601 B2 *	6/2003	Simoes	H02J 7/0034 320/11	7,180,754 B2 *	2/2007	Qin	H01M 2/1066 361/75
6,594,472 B1 *	7/2003	Curtis	H04M 1/0252 379/42	7,194,291 B2 *	3/2007	Peng	H04B 1/3888 455/57
6,614,722 B2 *	9/2003	Polany	H04R 1/44 367/13	D540,539 S *	4/2007	Gutierrez	D14/48
				7,203,467 B2 *	4/2007	Siddiqui	H04M 1/0249 379/43
				D542,286 S *	5/2007	Taniyama	D13/10
				D542,524 S *	5/2007	Richardson	D3/218
				D543,541 S *	5/2007	Chung	D3/218
				D544,486 S *	6/2007	Hussaini	D14/43
				7,230,823 B2 *	6/2007	Richardson	G06F 1/1626 220/23
				D547,056 S *	7/2007	Griffin	D3/218
				D547,057 S *	7/2007	Griffin	D3/218
				D550,455 S *	9/2007	Barnhart	D3/247
				D551,252 S *	9/2007	Andre	D14/49
				7,266,391 B2 *	9/2007	Warren	G06F 1/1616 343/70

US D950,538 S

D551,856 S *	10/2007	Ko	D3/201	7,647,082 B2 *	1/2010	Holmberg	G06F 1/1626
D553,857 S *	10/2007	Pendergraph	D3/273				206/32
D556,679 S *	12/2007	Weinstein	D13/10	D609,228 S *	2/2010	Ferrari	D14/25
D556,681 S *	12/2007	Kim	D13/10	D609,463 S *	2/2010	Bullen	D3/218
D557,205 S *	12/2007	Kim	D13/10	D610,538 S *	2/2010	Wu	D13/10
D557,264 S *	12/2007	Richardson	D14/39	7,656,120 B2 *	2/2010	Neu	G06F 1/1632
D557,494 S *	12/2007	Mayette	D3/218				320/11
D557,897 S *	12/2007	Richardson	D3/294	7,663,878 B2 *	2/2010	Swan	G06F 1/1632
7,312,984 B2 *	12/2007	Richardson	G06F 1/1626				361/67
			206/70	7,667,433 B1 *	2/2010	Smith	H01M 10/46
D558,667 S *	1/2008	Park	D13/10				320/11
D558,757 S *	1/2008	Andre	D14/13	D610,807 S *	3/2010	Bau	D3/269
D558,972 S *	1/2008	Oh	D3/201	D611,042 S *	3/2010	Ferrari	D14/25
D558,973 S *	1/2008	Hussaini	D3/201	D611,478 S *	3/2010	Richardson	D14/44
D559,267 S *	1/2008	Griffin	D14/16	7,669,829 B2 *	3/2010	Ogatsu	B60R 11/0241
D560,229 S *	1/2008	Yagi	D14/16				248/30
D561,092 S *	2/2008	Kim	D13/10	D613,282 S *	4/2010	Richardson	D14/25
7,336,973 B2 *	2/2008	Goldthwaite	G06Q 20/10	D615,077 S *	5/2010	Richardson	D14/25
			455/55	D615,535 S *	5/2010	Richardson	D14/25
D563,093 S *	3/2008	Nussberger	D3/201	D615,536 S *	5/2010	Richardson	D14/25
7,343,184 B2 *	3/2008	Rostami	A45C 11/00	D615,967 S *	5/2010	Richardson	D14/25
			224/66	D616,360 S *	5/2010	Huang	D13/10
D565,291 S *	4/2008	Brandenburg	D3/218	D616,361 S *	5/2010	Huang	D13/10
7,397,658 B2 *	7/2008	Finke-Anlauff	G06F 1/1624	D617,753 S *	6/2010	Cheng	D14/13
			345/16	D617,784 S *	6/2010	Richardson	D14/25
7,400,917 B2 *	7/2008	Wood	H04B 1/3888	D617,785 S *	6/2010	Richardson	D14/25
			455/57	D617,786 S *	6/2010	Richardson	D14/25
D574,326 S *	8/2008	Lim	D13/11	D617,787 S *	6/2010	Richardson	D14/25
D574,819 S *	8/2008	Andre	D3/269	D618,231 S *	6/2010	Fahrendorff	D14/25
D575,056 S *	8/2008	Tan	D3/201	7,733,637 B1 *	6/2010	Lam	G06F 1/1626
7,428,427 B2 *	9/2008	Brunstrom	H04M 1/0202				361/67
			455/55	D619,573 S *	7/2010	Khan	D14/25
D577,904 S *	10/2008	Sasaki	D3/201	D619,574 S *	7/2010	Richardson	D14/25
D581,151 S *	11/2008	Aipa	D3/201	D619,991 S *	7/2010	Huang	D14/13
D581,155 S *	11/2008	Richardson	D3/218	D620,000 S *	7/2010	Bau	D14/25
D581,421 S *	11/2008	Richardson	D14/44	D620,487 S *	7/2010	Richardson	D14/25
D582,149 S *	12/2008	Tan	D3/201	D621,394 S *	8/2010	Richardson	D14/25
7,464,814 B2 *	12/2008	Carnevali	G06F 1/1626	D621,395 S *	8/2010	Richardson	D14/25
			206/32	D621,821 S *	8/2010	Richardson	D14/25
D584,732 S *	1/2009	Cho	D14/43	D621,822 S *	8/2010	Richardson	D14/25
7,479,759 B2 *	1/2009	Vilanov	H02J 7/0044	7,778,023 B1 *	8/2010	Mohoney	G06F 1/1632
			320/10				312/22
D587,008 S *	2/2009	Richardson	D3/218	7,782,610 B2 *	8/2010	Diebel et al.	
D587,896 S *	3/2009	Aipa	D3/201	D623,179 S *	9/2010	Richardson	D14/25
D589,016 S *	3/2009	Richardson	D14/13	D623,180 S *	9/2010	Diebel	D14/25
D589,953 S *	4/2009	Turner	D14/24	D623,638 S *	9/2010	Richardson	D14/25
7,536,099 B2 *	5/2009	Dalby	H04M 1/0208	D623,639 S *	9/2010	Richardson	D14/25
			348/37	D623,640 S *	9/2010	Freeman	D14/25
D593,319 S *	6/2009	Richardson	D3/218	D624,317 S *	9/2010	Wenchel	D3/294
D593,746 S *	6/2009	Richardson	D3/201	D624,533 S *	9/2010	Richardson	D14/25
D594,849 S *	6/2009	Ko	D14/21	D624,908 S *	10/2010	Huskinson	D14/25
7,555,325 B2 *	6/2009	Goros	H04B 1/3888	D624,909 S *	10/2010	Huskinson	D14/25
			455/12	D624,910 S *	10/2010	Richardson	D14/25
D597,089 S *	7/2009	Khan	D14/25	D625,303 S *	10/2010	Kim	D14/25
7,562,813 B2 *	7/2009	Humphrey	G06Q 20/105	D626,120 S *	10/2010	Richardson	D14/25
			235/37	D626,121 S *	10/2010	Richardson	D14/25
D597,301 S *	8/2009	Richardson	D3/201	D626,538 S *	11/2010	Brown	D14/25
D598,407 S *	8/2009	Richardson	D14/13	D626,539 S *	11/2010	Brown	D14/25
7,577,462 B2 *	8/2009	Kumar	G06F 1/1632	D626,540 S *	11/2010	Brown	D14/25
			455/34	D626,964 S *	11/2010	Richardson	D14/44
D600,640 S *	9/2009	Stein	D13/10	D628,568 S *	12/2010	Richardson	D14/25
D600,908 S *	9/2009	Richardson	D3/218	D628,994 S *	12/2010	Griffin, Jr.	D14/25
D601,955 S *	10/2009	Ekmekdje	D13/10	7,859,222 B2 *	12/2010	Woud	H02J 7/0042
D601,959 S *	10/2009	Lee	D13/11				320/11
D601,960 S *	10/2009	Dai	D13/11	D631,246 S *	1/2011	Boettner	D3/203
7,609,512 B2 *	10/2009	Richardson	G06F 1/1626	7,863,856 B2 *	1/2011	Sherman	G06F 1/1626
			361/67				320/10
D603,602 S *	11/2009	Richardson	D3/218	7,863,862 B2 *	1/2011	Idzik	H02J 7/0044
D603,603 S *	11/2009	Laine	D3/218				320/11
7,612,997 B1 *	11/2009	Diebel et al.		D631,877 S *	2/2011	Rak	D14/25
D605,850 S *	12/2009	Richardson	D3/218	D632,648 S *	2/2011	Yang	D13/10
D606,528 S *	12/2009	Khan	D14/25	D632,683 S *	2/2011	Richardson	D14/25
D606,529 S *	12/2009	Ferrari	D14/25	D632,684 S *	2/2011	Richardson	D14/25
7,635,086 B2 *	12/2009	Spencer, II	G06Q 20/10	D632,685 S *	2/2011	Richardson	D14/25
			235/38	D632,686 S *	2/2011	Magness	D14/25
7,638,969 B2 *	12/2009	Woud	G06F 1/1632	7,889,489 B2 *	2/2011	Richardson	G06F 1/1626
			320/10				206/30
				7,889,498 B2 *	2/2011	Diebel et al.	

US D950,538 S

D634,704 S *	3/2011	Tieleman	D13/10	8,167,127 B2 *	5/2012	Martin	G11B 31/00
D634,741 S *	3/2011	Richardson	D14/25				206/32
7,899,397 B2 *	3/2011	Kumar	H04M 1/7253	D662,923 S *	7/2012	Piedra	D14/25
			455/41	D662,924 S *	7/2012	Melanson	D14/25
7,907,394 B2 *	3/2011	Richardson	G06F 1/1613	D663,263 S *	7/2012	Gupta	D13/10
			312/22	D663,319 S *	7/2012	Chen	D14/20
7,911,530 B2 *	3/2011	Sawachi	H04M 1/72527	D663,724 S *	7/2012	Lee	D14/24
			348/37	D664,091 S *	7/2012	Pliner	D13/10
D636,386 S *	4/2011	Richardson	D14/25	8,224,408 B2 *	7/2012	Tomasini	H04M 1/04
D636,387 S *	4/2011	Willes	D14/25				455/56
7,930,011 B2 *	4/2011	Shi	H05K 5/0243	D665,386 S *	8/2012	Fathollahi	D14/25
			206/32	D665,735 S *	8/2012	Kang	D13/10
7,933,122 B2 *	4/2011	Richardson	H05K 5/0017	8,245,842 B2 *	8/2012	Bau	B65D 85/00
			361/67				206/30
D637,588 S *	5/2011	Richardson	D14/25	8,247,102 B2 *	8/2012	Hua	H04M 1/04
D637,589 S *	5/2011	Willes	D14/25				429/10
D637,590 S *	5/2011	Michie	D14/25	D667,783 S *	9/2012	Zhang	D13/10
D637,591 S *	5/2011	Willes	D14/25	D670,281 S *	11/2012	Corpuz	D14/25
D637,592 S *	5/2011	Magness	D14/25	D670,689 S *	11/2012	Wang	D14/25
D637,952 S *	5/2011	Tan	D13/10	D671,105 S *	11/2012	Rothbaum	D14/25
D638,005 S *	5/2011	Richardson	D14/25	D671,106 S *	11/2012	Rothbaum	D14/25
D638,411 S *	5/2011	Willes	D14/25	D671,493 S *	11/2012	Hasbrook	D13/10
D638,413 S *	5/2011	Magness	D14/25	8,321,619 B2 *	11/2012	Kular	G11C 5/141
D638,414 S *	5/2011	Magness	D14/25				710/30
D638,828 S *	5/2011	Melanson	D14/25	8,328,008 B2 *	12/2012	Diebel	G06F 1/1626
D638,829 S *	5/2011	Melanson	D14/25				206/45
D638,830 S *	5/2011	Magness	D14/25	D674,394 S *	1/2013	Kajimoto	D14/25
D639,731 S *	6/2011	Sun	D13/10	8,342,325 B2 *	1/2013	Rayner	G06F 1/1626
D640,679 S *	6/2011	Willes	D14/25				206/32
D640,680 S *	6/2011	Magness	D14/25	D675,603 S *	2/2013	Melanson	D14/25
7,957,524 B2 *	6/2011	Chipping	G06F 1/1616	D676,032 S *	2/2013	Stump	D14/25
			206/32	D676,432 S *	2/2013	Hasbrook	D14/25
D641,013 S *	7/2011	Richardson	D14/25	8,367,235 B2 *	2/2013	Huang	H01M 2/1022
D641,014 S *	7/2011	Smith	D14/25				429/96
D641,974 S *	7/2011	Stampfli	D3/218	8,380,264 B2 *	2/2013	Hung	A45C 11/00
D642,169 S *	7/2011	Andre	D14/25				224/58
D642,170 S *	7/2011	Johnson	D14/25	D677,249 S *	3/2013	Li	D14/25
D642,171 S *	7/2011	Melanson	D14/25	D677,251 S *	3/2013	Melanson	D14/25
D642,558 S *	8/2011	Magness	D14/25	D678,869 S *	3/2013	Diebel	D14/25
D643,029 S *	8/2011	Feng	D14/25	8,390,255 B1 *	3/2013	Fathollahi	H02J 7/0045
D643,424 S *	8/2011	Richardson	D14/25				206/30
D644,215 S *	8/2011	Dong	D14/25	8,393,466 B2 *	3/2013	Rayner	G06F 1/1626
D644,216 S *	8/2011	Richardson	D14/25				206/32
D644,219 S *	8/2011	Sawada	D14/34	D679,271 S *	4/2013	Liu	D13/10
7,988,010 B2 *	8/2011	Yang	A45C 11/00	D679,684 S *	4/2013	Baker	D14/25
			220/37	D679,699 S *	4/2013	Piedra	D14/25
8,004,962 B2 *	8/2011	Yang	H04H 20/12	D681,020 S *	4/2013	Magness	D14/23
			370/21	D682,196 S *	5/2013	Leung	D13/10
D644,635 S *	9/2011	Richardson	D14/25	D682,815 S *	5/2013	Chang	B23K 35/38
D644,639 S *	9/2011	Weller	D14/25				228/20
D647,084 S *	10/2011	Fathollahi	D14/25	D683,338 S *	5/2013	Wilson	D14/25
D647,108 S *	10/2011	Lee	D14/20	8,439,191 B1 *	5/2013	Lu	H04B 1/3888
8,028,794 B1 *	10/2011	Freeman	A45C 11/00				206/32
			181/20	8,452,242 B2 *	5/2013	Spencer, II	G06Q 30/02
8,046,039 B2 *	10/2011	Lee	G06F 1/1626				455/90
			455/57	D684,554 S *	6/2013	Park	D14/13
D648,714 S *	11/2011	Jones, III	D14/25	8,457,701 B2 *	6/2013	Diebel	H04B 1/3888
D648,715 S *	11/2011	Jones, III	D14/25				455/57
D648,716 S *	11/2011	Jones, III	D14/25	D685,356 S *	7/2013	Diebel	D14/25
D648,717 S *	11/2011	Fahrendorff	D14/25	D685,737 S *	7/2013	de Jong	D13/119
D649,143 S *	11/2011	Jones, III	D14/25	D686,152 S *	7/2013	Lee	D13/10
D649,539 S *	11/2011	Hong	D14/25	D686,586 S *	7/2013	Cho	D14/13
D650,810 S *	12/2011	Lemelman	D14/20	D686,606 S *	7/2013	Hong	D14/25
D652,827 S *	1/2012	Fahrendorff	D14/25	8,483,758 B2 *	7/2013	Huang	H04B 1/3883
D652,828 S *	1/2012	Fahrendorff	D14/25				455/55
D653,202 S *	1/2012	Hasbrook	D13/10	D687,426 S *	8/2013	Requa	D14/25
D653,659 S *	2/2012	Fahrendorff	D14/25	D688,233 S *	8/2013	Dong	D14/25
D654,069 S *	2/2012	Kwon	D14/25	8,499,933 B2 *	8/2013	Ziamba	A45C 11/00
D654,483 S *	2/2012	Richardson	D14/25				206/32
D654,931 S *	2/2012	Lemelman	D14/49	8,505,718 B2 *	8/2013	Griffin, Jr	A45C 11/00
D655,281 S *	3/2012	Turocy	D14/25				206/32
D655,699 S *	3/2012	Bau	D14/25	8,509,864 B1 *	8/2013	Diebel	G03B 17/02
D656,495 S *	3/2012	Andre	D14/25				455/57
D658,165 S *	4/2012	Freeman	D14/25	8,509,865 B1 *	8/2013	LaColla	H04M 1/04
8,150,485 B2 *	4/2012	Lee	G06F 1/1626				455/55
			379/42	8,531,833 B2 *	9/2013	Diebel et al.	
D658,643 S *	5/2012	Fahrendorff	D14/25	D691,990 S *	10/2013	Rayner	D14/25

US D950,538 S

8,560,014	B1 *	10/2013	Hu	H04M 1/0283	D744,995	S *	12/2015	Lerenthal	D14/25
					361/67	D746,273	S *	12/2015	Herbst	D14/25
D693,801	S *	11/2013	Rayner	D14/25	D746,275	S *	12/2015	Mohammad	D14/25
8,579,172	B2 *	11/2013	Monaco	H04M 1/15	D746,801	S *	1/2016	Pan	D14/25
					224/66	D748,612	S *	2/2016	Chan	D14/25
D696,234	S *	12/2013	Wright	D14/25	D749,557	S *	2/2016	Feng	D14/25
D697,502	S *	1/2014	Chu	D14/25	D751,058	S *	3/2016	Cocchia	D14/25
D697,504	S *	1/2014	Yang	D14/25	D751,059	S *	3/2016	Cocchia	D14/25
D698,774	S *	2/2014	Wardy	D14/25	D751,542	S *	3/2016	Daniel	D14/25
D703,652	S *	4/2014	Melanson	D14/25	9,313,305	B1 *	4/2016	Diebel	G03B 17/02
D704,182	S *	5/2014	Smith	D14/25	9,319,501	B2 *	4/2016	Huang	H04B 1/3883
D704,688	S *	5/2014	Reivo	D14/25	D756,909	S *	5/2016	Gupta	D13/103
D705,199	S *	5/2014	Huang	D14/238.1	D756,910	S *	5/2016	Gupta	D13/10
D705,768	S *	5/2014	Melanson	D14/25	D756,911	S *	5/2016	Gupta	D13/103
D706,253	S *	6/2014	Simmer	D14/25	9,356,267	B1 *	5/2016	To et al.		
D706,255	S *	6/2014	Akana	D14/25	D759,641	S *	6/2016	Lai	D14/25
D706,256	S *	6/2014	Ward	D14/25	9,402,452	B2 *	8/2016	Diebel et al.		
D706,272	S *	6/2014	Poon	D14/44	9,406,913	B2 *	8/2016	Huang	H01M 2/1022
D709,058	S *	7/2014	Hemesath	D14/25	D765,628	S *	9/2016	Watt	D14/25
D709,439	S *	7/2014	Ferber	D13/10	D765,636	S *	9/2016	Kanazawa	D14/25
D709,485	S *	7/2014	Bishop	D14/25	D766,819	S *	9/2016	Gjovik et al.		
D710,344	S *	8/2014	Smith	D14/25	D767,485	S *	9/2016	To et al.		
D710,347	S *	8/2014	Esses	D14/25	D768,612	S *	10/2016	Wright	D14/25
D710,795	S *	8/2014	Gupta	D13/10	D771,612	S *	11/2016	Roberts	D14/250
D710,839	S *	8/2014	Chang	D14/25	D772,855	S *	11/2016	Ju	D14/25
D711,312	S *	8/2014	Tien	D13/10	9,495,375	B2 *	11/2016	Huang et al.		
D711,362	S *	8/2014	Poon	D14/25	9,545,140	B1	1/2017	Johnson et al.		
D711,863	S *	8/2014	Wen	D14/25	9,577,695	B2 *	2/2017	Huang	H01M 10/46
D714,274	S *	9/2014	Jung	D14/25	D781,839	S *	3/2017	Kim	D14/25
D714,278	S *	9/2014	Case	D14/25	D788,759	S *	6/2017	Akana	D14/250
8,837,156	B2 *	9/2014	Sun	H02J 7/0044	D789,346	S *	6/2017	Akana	D14/250
					320/11	9,735,595	B2	8/2017	Colahan et al.		
D716,784	S *	11/2014	Wen	D14/25	9,748,535	B2 *	8/2017	Huang	H01M 2/1022
D716,785	S *	11/2014	White	D14/25	D797,091	S *	9/2017	To et al.		
D717,781	S *	11/2014	Kim	D14/25	D797,092	S *	9/2017	To et al.		
D718,230	S *	11/2014	To	D13/103	D797,093	S *	9/2017	To et al.		
D718,289	S *	11/2014	Brand			9,755,444	B2 *	9/2017	To	H02J 7/0042
D718,291	S *	11/2014	Hong	D14/25	9,876,522	B2 *	1/2018	Huang	H04B 1/3888
D718,293	S *	11/2014	Namminga	D14/250	9,997,933	B2 *	6/2018	Huang et al.		
D718,754	S *	12/2014	To	D14/250	10,033,204	B2 *	7/2018	Huang et al.		
D718,755	S *	12/2014	To	D14/250	10,079,496	B2	9/2018	Huang et al.		
8,917,506	B2 *	12/2014	Diebel et al.			D835,087	S *	12/2018	Wilder	D14/250
D720,738	S *	1/2015	Rodriguez	D14/25	10,170,738	B2	1/2019	Huang et al.		
D720,740	S *	1/2015	Wicks	D14/25	D845,289	S *	4/2019	Chuang	D14/250
D721,356	S *	1/2015	Hasbrook et al.			D847,129	S	4/2019	To et al.		
D721,685	S *	1/2015	Hasbrook et al.			D850,373	S *	6/2019	Zhang	D13/108
D721,687	S *	1/2015	To	D14/250	D858,505	S *	9/2019	Zhang	D14/250
D722,043	S *	2/2015	Requa	D13/108	D860,179	S *	9/2019	Dang	D14/250
D722,312	S *	2/2015	Tages	D14/25	D861,654	S *	10/2019	Dang	D14/250
D723,018	S *	2/2015	White	D14/25	D862,441	S *	10/2019	Eppler	D14/250
8,954,117	B2 *	2/2015	Huang	H04B 1/3883	D869,453	S *	12/2019	Wilder	D14/250
					455/57	D870,091	S *	12/2019	Chen	D14/250
8,955,678	B2 *	2/2015	Murphy	B23P 19/00	D908,681	S *	1/2021	Coverstone	D14/250
					206/32	2001/0054148	A1 *	12/2001	Hoornaert	E21B 41/0042
D723,530	S *	3/2015	Namminga	D14/250						713/17
D724,065	S *	3/2015	Fathollahi	D14/25	2002/0065054	A1 *	5/2002	Humphreys	H04B 1/3888
D724,574	S *	3/2015	Williams	D14/25						455/57
D725,091	S *	3/2015	Wen	D14/25	2002/0111189	A1 *	8/2002	Chou	H04B 1/406
8,971,039	B2 *	3/2015	Huang	H01M 2/1022						455/55
					361/67	2002/0147035	A1 *	10/2002	Su	H04B 1/3877
D727,883	S *	4/2015	Brand	D14/250						455/57
D728,468	S *	5/2015	Ferber	D13/10	2002/0193136	A1 *	12/2002	Halkosaari	H04M 1/0283
9,026,187	B2 *	5/2015	Huang	H04B 1/3888						455/55
					455/57	2002/0197965	A1 *	12/2002	Peng	H04B 1/3888
D732,012	S *	6/2015	Tsai	D14/250						455/57
907,013	A1 *	7/2015	Huang	H01M 2/1022	2003/0000984	A1 *	1/2003	Vick, III	A45C 11/00
9,077,013	B2 *	7/2015	Huang	H01M 2/1022						224/61
9,088,028	B2 *	7/2015	Huang	H01M 2/1022	2003/0096642	A1 *	5/2003	Bessa	H04M 1/04
9,088,029	B2 *	7/2015	Huang	H01M 2/1022						455/57
D738,365	S *	9/2015	Melanson	D14/25	2003/0151890	A1 *	8/2003	Huang	G06F 1/1626
D739,394	S *	9/2015	Rayner	D14/25						361/67
9,123,935	B2 *	9/2015	Huang	H01M 10/46	2003/0217210	A1 *	11/2003	Carau, Sr.	G06F 1/26
D740,797	S *	10/2015	Daniel	D14/25						710/30
D741,844	S *	10/2015	Rayner	D14/25	2003/0218445	A1 *	11/2003	Behar	H02J 7/0044
9,153,985	B1 *	10/2015	Gjovik	H02J 7/0042						320/11
9,172,070	B2 *	10/2015	Huang	H01M 2/1022	2003/0228866	A1 *	12/2003	Pezeshki	H04W 8/245
D744,472	S *	12/2015	Lerenthal	D14/25						455/42
D744,989	S *	12/2015	Lee	D14/24						
D744,993	S *	12/2015	Diebel	D14/25						

US D950,538 S

2004/0096054	A1*	5/2004	Nuovo	H04M	1/0249 379/43	2007/0225031	A1*	9/2007	Bodkin	A45C	3/001 455/55
2004/0097256	A1*	5/2004	Kujawski	H04M	1/72527 455/55	2007/0236180	A1*	10/2007	Rodgers	H02J	7/0044 320/11
2004/0104268	A1*	6/2004	Bailey	G06Q	20/32 235/43	2007/0261978	A1*	11/2007	Sanderson	A45C	11/22 206/32
2004/0247113	A1*	12/2004	Akatsu	H04M	1/02 379/41	2007/0297149	A1*	12/2007	Richardson	G06F	1/1626 361/73
2004/0268005	A1*	12/2004	Dickie	G06F	1/1616 710/30	2008/0007214	A1*	1/2008	Cheng	H02J	7/0044 320/11
2005/0049016	A1*	3/2005	Cho	H04M	1/0202 455/57	2008/0026794	A1*	1/2008	Warren	H04M	1/72527 455/55
2005/0088141	A1*	4/2005	Lee	A45F	5/00 320/11	2008/0026803	A1*	1/2008	Demuyneck	H04M	1/0202 455/57
2005/0090301	A1*	4/2005	Lange	B60R	11/0241 455/57	2008/0032758	A1*	2/2008	Rostami	A45C	11/00 455/57
2005/0093510	A1*	5/2005	Seii	H01M	2/1055 320/11	2008/0053770	A1*	3/2008	Tynyk	A45C	11/00 190/10
2005/0116684	A1*	6/2005	Kim	B60R	11/0241 320/11	2008/0058010	A1*	3/2008	Lee	H04M	1/0264 455/55
2005/0130721	A1*	6/2005	Gartrell	H04M	1/0283 455/57	2008/0096620	A1*	4/2008	Lee	G06F	1/1626 455/57
2005/0231159	A1*	10/2005	Jones, Sr.	H02J	7/0044 320/11	2008/0108395	A1*	5/2008	Lee	H04M	1/0262 455/57
2005/0247787	A1*	11/2005	Von Mueller	G06F	1/1632 235/44	2008/0119244	A1*	5/2008	Malhotra	B29C	45/0053 455/57
2005/0248312	A1*	11/2005	Cao	H02J	7/0031 320/11	2008/0123287	A1*	5/2008	Rossell	G06F	1/1632 361/67
2005/0286212	A1*	12/2005	Brignone	G06F	1/1632 361/67	2008/0132289	A1*	6/2008	Wood	H04B	1/3888 455/56
2006/0003709	A1*	1/2006	Wood	H04B	1/3888 455/90	2008/0139258	A1*	6/2008	Park	H01R	13/447 455/57
2006/0010588	A1*	1/2006	Schuster	A45C	7/0081 2/455	2008/0150367	A1*	6/2008	Oh	H01M	2/1022 307/80
2006/0052064	A1*	3/2006	Goradesky	A45F	5/02 455/90	2009/0009945	A1*	1/2009	Johnson	G06F	1/1613 361/67
2006/0058073	A1*	3/2006	Kim	H02J	7/0044 455/57	2009/0017883	A1*	1/2009	Lin	A45C	11/00 455/57
2006/0063569	A1*	3/2006	Jacobs	G06F	1/1624 455/57	2009/0051319	A1*	2/2009	Fang	H02J	7/0044 320/11
2006/0099999	A1*	5/2006	Park	H01M	10/488 455/57	2009/0069050	A1*	3/2009	Jain	G06K	19/07739 455/55
2006/0105722	A1*	5/2006	Kumar	G06F	1/1632 455/90	2009/0073650	A1*	3/2009	Huang	G06F	1/1632 361/67
2006/0105824	A1*	5/2006	Kim	H04M	1/0214 455/57	2009/0096417	A1*	4/2009	Idzik	H02J	7/0044 320/11
2006/0125445	A1*	6/2006	Cao	H02J	7/0031 320/11	2009/0108800	A1*	4/2009	Woud	G06F	1/1632 320/10
2006/0140461	A1*	6/2006	Kim	G06F	1/1613 382/12	2009/0111543	A1*	4/2009	Tai	H04B	1/3888 455/57
2006/0197674	A1*	9/2006	Nakajima	H01H	13/705 340/4	2009/0114556	A1*	5/2009	Tai	H04M	1/185 206/32
2006/0205447	A1*	9/2006	Park	H04M	1/0235 455/57	2009/0117955	A1*	5/2009	Lo	H04M	1/0216 455/57
2006/0255493	A1*	11/2006	Fouladpour	B29C	51/10 264/16	2009/0128092	A1*	5/2009	Woud	G06F	1/1632 361/67
2007/0004450	A1*	1/2007	Parikh	G06F	1/1626 455/55	2009/0143104	A1*	6/2009	Loh	G06Q	20/32 455/55
2007/0019804	A1*	1/2007	Kramer	A45C	11/00 379/43	2009/0144456	A1*	6/2009	Gelf	G06F	13/4022 710/8
2007/0093140	A1*	4/2007	Begic	H04M	1/0252 439/67	2009/0146898	A1*	6/2009	Akiho	H01Q	1/243 343/78
2007/0123316	A1*	5/2007	Little	G06F	21/31 455/57	2009/0152089	A1*	6/2009	Hanes	H01H	13/06 200/34
2007/0142097	A1*	6/2007	Hamasaki	H02J	7/0044 455/57	2009/0160399	A1*	6/2009	Woud	H02J	7/0042 320/11
2007/0152633	A1*	7/2007	Lee	G06F	1/1632 320/11	2009/0160400	A1*	6/2009	Woud	H02J	7/0042 320/11
2007/0161404	A1*	7/2007	Yasujima	H04W	88/06 455/55	2009/0181729	A1*	7/2009	Griffin, Jr.	H04N	5/2254 455/57
2007/0167190	A1*	7/2007	Moosavi	H04M	1/04 455/55	2009/0205983	A1*	8/2009	Estlander	H04M	1/0252 206/30
2007/0187563	A1*	8/2007	Ogatsu	B60R	11/0241 248/34	2009/0247244	A1*	10/2009	Mittleman	H04M	1/035 455/57
2007/0223182	A1*	9/2007	Swan	G06F	1/1632 361/73	2009/0284216	A1*	11/2009	Bessa	H02J	7/0044 320/10

US D950,538 S

2009/0301289	A1*	12/2009	Gynes	G10H	1/0066	84/645	2011/0261511	A1*	10/2011	Alderson	H01H	13/86
2009/0312058	A9*	12/2009	Wood	H04B	1/3888	455/56	2011/0297578	A1*	12/2011	Stiehl	B29C	45/1676
2009/0314400	A1*	12/2009	Liu	A45C	11/00	150/16	2011/0309728	A1*	12/2011	Diebel	H04B	1/3888
2009/0325657	A1*	12/2009	Ramsdell	A45C	7/0063	455/57	2012/0013295	A1*	1/2012	Yeh	H02J	7/025
2010/0005225	A1*	1/2010	Honda	G06F	3/0607	711/10	2012/0071214	A1*	3/2012	Ash, Jr.	H01Q	1/243
2010/0013431	A1*	1/2010	Liu	G06F	1/1632	320/10	2012/0088555	A1*	4/2012	Hu	H04B	1/3883
2010/0022277	A1*	1/2010	An	H04M	1/72527	455/56	2012/0088558	A1*	4/2012	Song	H04M	1/18
2010/0026589	A1*	2/2010	Dou	H01Q	1/2258	343/70	2012/0106037	A1*	5/2012	Diebel	G06F	1/1628
2010/0048267	A1*	2/2010	Lin	H04M	1/0266	455/57	2012/0115551	A1*	5/2012	Cho	H04M	1/23
2010/0056054	A1*	3/2010	Yamato	H04W	52/50	455/41	2012/0119695	A1*	5/2012	Pin	H02J	7/0052
2010/0064883	A1*	3/2010	Gynes	G10H	1/32	84/645	2012/0122520	A1*	5/2012	Phillips	G06K	19/005
2010/0078343	A1*	4/2010	Hoellwarth	B29C	45/14639	206/32	2012/0161696	A1*	6/2012	Cook	B60L	11/182
2010/0088439	A1*	4/2010	Ang	G06F	1/1632	710/10	2012/0177967	A1*	7/2012	Wang	G06F	1/1632
2010/0093412	A1*	4/2010	Serra	H04B	1/3888	455/57	2012/0209745	A1*	8/2012	Spencer, II	G06Q	20/327
2010/0096284	A1*	4/2010	Bau	H04B	1/3888	206/32	2012/0282977	A1*	11/2012	Haleluk	H04B	1/3888
2010/0113106	A1*	5/2010	Supran	G06F	1/1632	455/57	2012/0302294	A1*	11/2012	Hammond	H04M	1/18
2010/0124040	A1*	5/2010	Diebel	G06F	1/1628	361/816	2012/0305422	A1*	12/2012	Vandiver	H04M	1/185
2010/0132724	A1*	6/2010	Seidel	A24D	1/16	131/33	2012/0320501	A1*	12/2012	Ackloo	H04B	1/3888
2010/0154062	A1*	6/2010	Baram	G06F	21/564	726/24	2012/0325637	A1*	12/2012	Kikuchi	H01H	13/063
2010/0195279	A1*	8/2010	Michael	G06F	1/1632	361/67	2013/0023313	A1*	1/2013	Kim	H04M	1/04
2010/0200456	A1*	8/2010	Parkinson	B29C	33/485	206/70	2013/0045775	A1*	2/2013	Heywood	H04B	1/3888
2010/0203931	A1*	8/2010	Hynecek	A45C	11/00	455/57	2013/0052871	A1*	2/2013	Eklind	H04M	1/04
2010/0224519	A1*	9/2010	Kao	A45C	11/00	206/32	2013/0082662	A1*	4/2013	Carre	H02J	7/0052
2010/0243516	A1*	9/2010	Martin	G11B	31/00	206/70	2013/0084799	A1*	4/2013	Marholev	H03F	3/245
2010/0302716	A1*	12/2010	Gandhi	G06F	1/1624	361/67	2013/0088815	A1*	4/2013	Hu	G06F	1/1628
2010/0328203	A1*	12/2010	Hsu	G06F	1/1607	345/15	2013/0098790	A1*	4/2013	Hong	A45C	11/00
2011/0021255	A1*	1/2011	Kim	H01Q	1/242	455/57	2013/0125251	A1*	5/2013	Johnson	G06F	21/70
2011/0034221	A1*	2/2011	Hung	A45C	11/00	455/57	2013/0146491	A1*	6/2013	Ghali	G06F	1/1626
2011/0049005	A1*	3/2011	Wilson	A45C	11/00	206/70	2013/0189923	A1*	7/2013	Lewin	H04B	5/02
2011/0050164	A1*	3/2011	Partovi	H01F	5/003	320/10	2013/0210475	A1*	8/2013	Nylund	H04B	5/0006
2011/0055447	A1*	3/2011	Costa	G06F	1/1632	710/30	2013/0248339	A1*	9/2013	Koepsell	H01H	13/20
2011/0084081	A1*	4/2011	Chung	A45C	11/00	220/62	2013/0273983	A1*	10/2013	Hsu	H05K	5/0086
2011/0090626	A1*	4/2011	Hoellwarth	B29C	45/14639	361/67	2013/0307818	A1*	11/2013	Pope	G06F	3/044
2011/0117974	A1*	5/2011	Spitalnik	H01R	31/06	455/57	2013/0314030	A1*	11/2013	Fathollahi	H02J	7/0045
2011/0136555	A1*	6/2011	Ramies	B67B	7/16	455/57	2013/0318282	A1*	11/2013	Wakutsu	G06F	12/0246
2011/0199041	A1*	8/2011	Yang	H01M	10/46	320/10	2014/0035511	A1*	2/2014	Ferber	H02J	7/0042
2011/0253569	A1*	10/2011	Lord	B65D	25/20	206/32	2014/0065948	A1*	3/2014	Huang	H04B	1/3888
2011/0259664	A1*	10/2011	Freeman	A45C	11/00	181/20	2014/0069825	A1*	3/2014	Macrina	A45C	11/00

2014/0268518	A1 *	3/2014	Huang	H04B	1/3883 361/67	U.S. Appl. No. 29/528,266, filed May 27, 2015.*
2014/0141838	A1 *	5/2014	Cai	H04M	1/72575 455/55	U.S. Appl. No. 29/534,901, filed Jul. 31, 2015.*
2014/0165379	A1 *	6/2014	Diebel	G06F	1/1628 29/592	U.S. Appl. No. 15/223,683, filed Jul. 29, 2016.*
2014/0239916	A1 *	8/2014	To	H02J	7/0042 320/13	U.S. Appl. No. 15/223,735, filed Jul. 29, 2016.*
2014/0268519	A1 *	9/2014	Huang	H04B	1/3888 361/67	U.S. Appl. No. 29/556,805, filed Mar. 3, 2016.*
2014/0375182	A1 *	12/2014	Li	G06F	1/1679 312/22	U.S. Appl. No. 29/556,807, filed Mar. 3, 2016.*
2014/0375186	A1 *	12/2014	Tarnow	H04M	1/0202 312/22	U.S. Appl. No. 29/626,999, filed Nov. 21, 2017.*
2015/0140386	A1 *	5/2015	Huang	H01M	2/1022 429/98	U.S. Appl. No. 15/820,197, filed Nov. 21, 2017.*
2015/0141090	A1 *	5/2015	Hwan	H04B	1/3888 455/57	U.S. Appl. No. 14/187,046, filed Feb. 21, 2014, Name not available.*
2015/0189053	A1 *	7/2015	LaHam	H04M	1/11 455/57	U.S. Appl. No. 14/205,167, filed Mar. 11, 2014, Name not available.*
2015/0194648	A1 *	7/2015	Fathollahi	H01M	2/1061 429/98	U.S. Appl. No. 29/382,515, filed Jan. 4, 2011.*
2015/0194833	A1 *	7/2015	Fathollahi	H02J	7/0044 320/11	U.S. Appl. No. 29/510,154, filed Nov. 25, 2014.*
2015/0214993	A1 *	7/2015	Huang	H04B	1/3888 455/11	U.S. Appl. No. 29/510,153, filed Nov. 25, 2014.*
2015/0215439	A1 *	7/2015	Stanimirovic	H04M	1/215 455/57	U.S. Appl. No. 29/510,839, filed Dec. 3, 2014.*
2015/0281410	A1 *	10/2015	Takahashi	H04M	1/026 455/57	U.S. Appl. No. 15/130,196, filed Apr. 15, 2016.*
2015/0289615	A1 *	10/2015	Welsch	G06F	1/163 224/21	“Sandberg BatteryCase for iPhone 4/4S delivers more band for your buck,” dated Mar. 15, 2012, http://www.gizmag.com/sanberg-battery-case-iphone/21839 .*
2015/0303722	A1 *	10/2015	Li	H02J	7/0045 320/11	Shawn Brown, “Incuse Power Slider battery doubles as a case,” dated Nov. 19, 2008, http://www.iphonebuzz.com/incuse-power-slider-battery-doubles-as-a-case-195224.php .*
2015/0364875	A1 *	12/2015	Ginsberg	H01R	13/72 320/11	Nick Guy, “Incipio offGRID Battery Case for iPhone 5/5s,” dated Oct. 9, 2013, http://www.ilounge.com/index.php/reviews/entry/incipio-offgrid-battery-case-for-iphone-5-5s/ .*
2015/0381226	A1 *	12/2015	Mogol	H04B	1/3888 455/57	Jeremy Horwitz, “Mophie Juice Pack Plus for iPhone 5,” dated May 21, 2013, http://www.ilounge.com/index.php/reviews/entry/mophie-juice-pack-plus-for-iphone-5/ .*
2016/0004896	A1 *	1/2016	Pope	G06F	3/044 382/12	Devin Coldewey, “Combination iPhone battery pack and flash from FastMac,” dated Nov. 4, 2008, http://crunchgear.com/2008/11/04/combination-iphone-battery-pack-and-flash-from-fastmac/ .*
2016/0064962	A1 *	3/2016	Huang et al.				Brian Nyhuis, “Mophie Juice Pack Battery Case For Samsung Galaxy S III Review,” dated Nov. 28, 2012, http://www.legitreviews.com/mophie-juice-pack-battery-case-for-samsung-galaxy-s-iii-review_2084 .*
2016/0064963	A1 *	3/2016	Huang et al.				“PowerSkin Samsung Galaxy S3 Case with Backup Battery,” dated Aug. 19, 2012, http://gadgets.in.com/powerskin-samsung-galaxy-s3-case-with-backup-battery.htm .*
2016/0064979	A1 *	3/2016	Huang et al.				“iPhone 4 Case with Battery Pack,” dated Sep. 28, 2010, http://gadgets.in.com/iphone-4-case-with-battery-pack.htm .*
2016/0112085	A1 *	4/2016	Johnson	H04M	1/04 455/57	Jonathan Pena, “iPhone 5 Cases, Round 3,” dated Sep. 16, 2012, http://www.technologytell.com/apple/103833/iphone-5-cases-round-3/ .*
2016/0181580	A1 *	6/2016	To	H01M	2/1066 429/10	Jeremy Horwitz, “Mophie Juice Pack for iPhone,” dated Dec. 7, 2007, http://www.ilounge.com/index.php/reviews/entry/mophie-juice-pack-for-iphone/ .*
2016/0267313	A1 *	9/2016	Pope	G06F	3/044	Dr. Macenstein, “Review: Mophie Juice Pack for iPhone,” dated Apr. 27, 2008, http://macenstein.com/default/2008/04/review-mophie-juice-pack-for-iphone/ .*
2016/0308569	A1 *	10/2016	Wei	H02J	7/00	Wayne Schulz, “iPhone Extended Battery Review—Mophie Juice Pack,” dated Jun. 17, 2008, http://www.geardiary.com/2008/06/17/iphone-extended-battery-review-mophie-juice-pack/ .*
2018/0076428	A1 *	3/2018	Huang et al.				Mophie Juice Pack iPhone 1G Product—Figures 1-7—Retrieved from http://www.mophie.com/products/juice-pack on Apr. 10, 2009.*
2019/0158136	A1	5/2019	DiLella				Mophie Juice Pack iPhone 1G Product—Figures 15-16—Retrieved from http://mophie.com/blogs/Juice_Pack_FAQ on Apr. 20, 2009. Figure 16 is dated May 1, 2008.*

FOREIGN PATENT DOCUMENTS

CN	201252577	Y	*	6/2009
CN	202364273	U	*	8/2012
CN	302510329	S	*	7/2013
CN	302573150	S	*	9/2013
KR	30-0650361		*	7/2012
TW	D150044		*	11/2012
TW	D156538		*	10/2013

OTHER PUBLICATIONS

- U.S. Appl. No. 15/130,196, filed Apr. 15, 2016, Name not available.*
- U.S. Appl. No. 29/382,515, filed Jan. 4, 2011, Name not available.*
- U.S. Appl. No. 29/464,620, filed Aug. 19, 2013.*
- U.S. Appl. No. 29/478,391, filed Jan. 3, 2014.*
- U.S. Appl. No. 29/478,390, filed Jan. 3, 2014.*
- U.S. Appl. No. 29/478,383, filed Jan. 3, 2014.*
- U.S. Appl. No. 29/478,388, filed Jan. 3, 2014.*
- U.S. Appl. No. 29/499,868, filed Aug. 19, 2014.*
- U.S. Appl. No. 29/539,419, filed Sep. 14, 2015.*
- U.S. Appl. No. 29/523,209, filed Apr. 7, 2015.*

- U.S. Appl. No. 29/528,266, filed May 27, 2015.*
- U.S. Appl. No. 29/534,901, filed Jul. 31, 2015.*
- U.S. Appl. No. 15/223,683, filed Jul. 29, 2016.*
- U.S. Appl. No. 15/223,735, filed Jul. 29, 2016.*
- U.S. Appl. No. 29/556,805, filed Mar. 3, 2016.*
- U.S. Appl. No. 29/556,807, filed Mar. 3, 2016.*
- U.S. Appl. No. 29/626,999, filed Nov. 21, 2017.*
- U.S. Appl. No. 15/820,197, filed Nov. 21, 2017.*
- U.S. Appl. No. 14/187,046, filed Feb. 21, 2014, Name not available.*
- U.S. Appl. No. 14/205,167, filed Mar. 11, 2014, Name not available.*
- U.S. Appl. No. 29/382,515, filed Jan. 4, 2011.*
- U.S. Appl. No. 29/510,154, filed Nov. 25, 2014.*
- U.S. Appl. No. 29/510,153, filed Nov. 25, 2014.*
- U.S. Appl. No. 29/510,839, filed Dec. 3, 2014.*
- U.S. Appl. No. 15/130,196, filed Apr. 15, 2016.*
- “Sandberg BatteryCase for iPhone 4/4S delivers more band for your buck,” dated Mar. 15, 2012, <http://www.gizmag.com/sanberg-battery-case-iphone/21839>.*
- Shawn Brown, “Incuse Power Slider battery doubles as a case,” dated Nov. 19, 2008, <http://www.iphonebuzz.com/incuse-power-slider-battery-doubles-as-a-case-195224.php>.*
- Nick Guy, “Incipio offGRID Battery Case for iPhone 5/5s,” dated Oct. 9, 2013, <http://www.ilounge.com/index.php/reviews/entry/incipio-offgrid-battery-case-for-iphone-5-5s/>.*
- Jeremy Horwitz, “Mophie Juice Pack Plus for iPhone 5,” dated May 21, 2013, <http://www.ilounge.com/index.php/reviews/entry/mophie-juice-pack-plus-for-iphone-5/>.*
- Devin Coldewey, “Combination iPhone battery pack and flash from FastMac,” dated Nov. 4, 2008, <http://crunchgear.com/2008/11/04/combination-iphone-battery-pack-and-flash-from-fastmac/>.*
- Brian Nyhuis, “Mophie Juice Pack Battery Case For Samsung Galaxy S III Review,” dated Nov. 28, 2012, http://www.legitreviews.com/mophie-juice-pack-battery-case-for-samsung-galaxy-s-iii-review_2084.*
- “PowerSkin Samsung Galaxy S3 Case with Backup Battery,” dated Aug. 19, 2012, <http://gadgets.in.com/powerskin-samsung-galaxy-s3-case-with-backup-battery.htm>.*
- “iPhone 4 Case with Battery Pack,” dated Sep. 28, 2010, <http://gadgets.in.com/iphone-4-case-with-battery-pack.htm>.*
- Jonathan Pena, “iPhone 5 Cases, Round 3,” dated Sep. 16, 2012, <http://www.technologytell.com/apple/103833/iphone-5-cases-round-3/>.*
- Jeremy Horwitz, “Mophie Juice Pack for iPhone,” dated Dec. 7, 2007, <http://www.ilounge.com/index.php/reviews/entry/mophie-juice-pack-for-iphone/>.*
- Dr. Macenstein, “Review: Mophie Juice Pack for iPhone,” dated Apr. 27, 2008, <http://macenstein.com/default/2008/04/review-mophie-juice-pack-for-iphone/>.*
- Wayne Schulz, “iPhone Extended Battery Review—Mophie Juice Pack,” dated Jun. 17, 2008, <http://www.geardiary.com/2008/06/17/iphone-extended-battery-review-mophie-juice-pack/>.*
- Mophie Juice Pack iPhone 1G Product—Figures 1-7—Retrieved from <http://www.mophie.com/products/juice-pack> on Apr. 10, 2009.*
- Mophie Juice Pack iPhone 1G Product—Figures 15-16—Retrieved from http://mophie.com/blogs/Juice_Pack_FAQ on Apr. 20, 2009. Figure 16 is dated May 1, 2008.*
- Tomas Ratas, “Mophie Juice Pack—iPhone 3G,” dated Dec. 9, 2008, <http://www.testfreaks.com/blog/review/mophie-juice-pack-iphone-3g/>.*
- Dr. Macenstein, “Review: Mophie Juice Pack 3G For iPhone,” dated Nov. 27, 2008, <http://macenstein.com/default/archives/1820>.*
- Mophie Juice Pack iPhone 3G Product—Figures 1-8—Retrieved from <http://www.mophie.com/products/juice-pack-iphone-3g> on Apr. 10, 2009.*
- Mophie Juice Pack iPhone 3G Product—Figures 9-10—Retrieved from <http://www.mophie.com/pages/iphone-3g-details> on Apr. 10, 2009.*
- Mophie Juice Pack iPhone 3G Product—Figures 11-14—Retrieved from http://mophie.com/blogs/Juice_Pack_3G_FAQ on Apr. 10, 2009.*

- Mophie Juice Pack iPhone 3G Product—Figures 15-16—Retrieved from <http://mophie.com/blogs/press> on Apr. 20, 2009. Figure 15 is dated Aug. 4, 2008, and Figure 16 is dated Nov. 10, 2008.*
- Chris Foresman, “Several Backup Batteries Can Extend Your Daily iPhone 3G Use,” dated Jul. 18, 2008, <http://arstechnica.com/apple/2008/07/several-backup-batteries-can-extend-your-daily-iphone-3g-use/>.*
- Incase Power Slider 3G for iPhone 3G Product Reference, alleged by Incase to be available on Nov. 28, 2008.*
- Joseph Flatley, “Incase Power Slider for iPhone 3G Doubles the Juice, Lets You Sync,” dated Nov. 17, 2008. URL: <https://www.engadget.com/2008/11/17/incase-power-slider-for-iphone-3g-doubles-the-juice-lets-you-sy/>.*
- Darren Quick, “Mophie Juice Pack for iPhone 3G now shipping,” dated Nov. 10, 2008, <http://www.gizmag.com/mophie-juice-pack-iphone-3g/10342/>.*
- Jeremy Horwitz, “PhoneSuit MiLi Power Pack for iPhone,” Jan. 29, 2009, <http://www.ilounge.com/index.php/reviews/entry/phonesuit-mili-power-pack-for-iphone/>.*
- Jeremy Horwitz, “FastMac TruePower iV Universal Battery Charger,” Dec. 11, 2008, <http://www.ilounge.com/index.php/reviews/entry/fastmac-truepower-iv-universal-battery-charger/>.*
- Jeremy Horwitz, “Konnet PowerKZ Extended Power for iPhone,” Apr. 2, 2009, <http://www.ilounge.com/index.php/reviews/entry/konnet-powerkz-extended-power-for-iphone/>.*
- Jeremy Horwitz, “Review: Anker s Ultra Slim Battery Case for iPhone 6 offers a surprising mix of thinness, power, and low pricing,” 9to5Mac, posted Mar. 13, 2015, accessed May 29, 2018, <https://9to5mac.com/2015/03/13/review-ankers-ultra-slim-battery-case-iphone-6/>.*
- “Test: Batterie iPhone SKPAD” with Machine English Translation, Feb. 2, 2009, <http://iphonesofa.com/2009/02/02/test-batterie-iphone-skpad/>.*
- Webpage Archive, Mophie.com, Nov. 25, 2007.*
- Ben Kaufman, “Behind the Invention: The mophie Juice Pack,” dated Dec. 31, 2013, <https://medium.com/@benkaufman/behind-the-invention-the-mophie-juice-pack-a0620f74efcf>.*
- Amazon.com, “Galaxy S6 Battery Case, i-Blason External Protective Battery Case/Cover for Samsung Galaxy S6 2015 Release.” Customer Review published Mar. 29, 2015. Retrieved from internet at <http://www.amazon.com/Case-i-Blason-External-Protective-Versions/dp/BOOSNS4LME>, Apr. 28, 2016. 7 pages.*
- International Search Report and Written Opinion of the International Searching Authority for PCT/US2011/037244, dated Jul. 19, 2011.*
- International Preliminary Report on Patentability for PCT/US2011/037244, dated Nov. 29, 2012.*
- International Search Report and Written Opinion of the International Searching Authority for PCT/US2011/037249, dated Jul. 13, 2011.*
- International Preliminary Report on Patentability for PCT/US2011/037249, dated Nov. 29, 2012.*
- International Search Report and Written Opinion of the International Searching Authority for PCT/US2011/037254, dated Jul. 13, 2011.*
- International Preliminary Report on Patentability for PCT/US2011/037254, dated Nov. 29, 2012.*
- International Search Report and Written Opinion of the International Searching Authority for PCT/US2011/037257, dated Sep. 22, 2011.*
- International Preliminary Report on Patentability for PCT/US2011/037257, dated Nov. 29, 2012.*
- International Search Report and Written Opinion of the International Searching Authority for PCT/US2012/041768, dated Feb. 27, 2013.*
- International Preliminary Report on Patentability for PCT/US2012/041768, dated Dec. 27, 2013.*
- International Search Report and Written Opinion of the International Searching Authority for PCT/US2013/057276, dated Dec. 10, 2013.*
- International Preliminary Report on Patentability for PCT/US2013/057276, dated Mar. 3, 2015.*
- International Search Report and Written Opinion of the International Searching Authority for PCT/US2014/017781, dated Jun. 8, 2014.*
- International Preliminary Report on Patentability for PCT/US2014/017781, dated Aug. 25, 2015.*
- International Search Report and Written Opinion of the International Searching Authority for PCT/US2014/023592, dated Aug. 28, 2014.*
- International Preliminary Report on Patentability for PCT/US2014/023592, dated Sep. 15, 2015.*
- International Search Report and Written Opinion for PCT/US2014/067470, dated Mar. 31, 2015.*
- International Preliminary Report of Patentability for PCT/US2014/067470, dated Jun. 9, 2016.*
- International Search Report and Written Opinion for PCT/US2015/065800, dated Apr. 21, 2016.*
- Mophie Pulse for iPod Touch 4G, http://www.mophie.com/pulse-iPod-Touch-4th-Gen-vibrating-gaming-case-p/2015_PU L-T4-GRY.htm.*
- Nick Guy, “RND Power Solutions Sync & Charge Dock with Lightning Connector,” dated Nov. 18, 2013, <http://www.ilounge.com/index.php/reviews/entry/tylt-energi-sl>.*
- Jeremy Horwitz, “Kensington Mini Battery Pack and Charger for iPhone and iPod,” dated May 16, 2008, <http://www.ilounge.com/index.php/reviews/entry/kensington-mini-battery-pack-and-charger-for-iphone-and-ipod/>.*
- Kensington Mini Battery Pack and Charger for iPhone and iPod, dated Sep. 30, 2008, 1 Page.*
- Sven Rafferty, “Mybat External Battery for iPhone and iPod,” dated May 18, 2008, <http://svenontech.com/reviews/?p=74>.*
- Dave Rees, “Richard Solo Backup Battery for iPhone / iPod Review,” dated Jun. 16, 2008, http://the-gadgeteer.com/2008/06/16/richard_solobackupbatteryforiphoneipod/.*
- “Cheap DIY iPhone External Battery,” dated Jul. 22, 2008, <http://fastdad.wordpress.com/2008/07/22/cheap-diy-iphone-external-battery/>.*
- Jeremy Horwitz, “iLuv i603 / i604 Rechargeable Lithium Polymer Batteries with Silicone Skin,” dated Jun. 27, 2006, <http://www.ilounge.com/index.php/reviews/entry/iluv-i603-rechargeable-lithium-polymer-battery-with-silicone-skin/>.*
- Julie Strietelmeier, “Seidio INNODock Desktop Cradle for Treo 650,” dated Jul. 28, 2005, http://the-gadgeteer.com/2005/07/28/seidio_innodock_desktopcradlefortreo_650/.*
- Dr. Macenstein, “Review: Mophie Juice Pack for iPhone,” dated Apr. 27, 2008, <http://macenstein.com/default/archives/1314>.*
- Mophie Juice Pack iPhone 1G Product—Figure 8—Retrieved from <http://www.mophie.com/pages/information/> on Apr. 10, 2009.*
- Mophie Juice Pack iPhone 1G Product—Figures 9-14—Retrieved from <http://www.mophie.com/blogs/JuicePackFAQ> on Apr. 10, 2009.*
- Ewdison Then, “Mophie Juice Pack iPhone 3G Review,” dated Nov. 12, 2008, <http://www.slashgear.com/mophie-juice-pack-iphone-3g-review-1222446/>.*
- Mophie Juice Pack iPhone 3G User Manual—Retrieved from http://static3.shopify.com/s/files/1/0008/4942/assets/mophiejuicepack_3G_manual_rl.pdf on Apr. 10, 2009.*
- Panasonic Lithium Ion Batteries Technical Handbook, dated 2007.*
- Using Your Treo 650 Smartphone by palmOne, dated 2005.*
- Lisa Gade, “Palm Treo 750,” dated Jan. 17, 2007, <http://www.mobiletechreview.com/phones/Treo-750.htm>.*
- iPhone User’s Guide, 2007.*
- “Power Slider,” Web Archive Date Dec. 4, 2008, <https://web.archive.org/web/20081204105303/http://goincase.com/products/detail/powe-r-slider-ec20003/?>*
- Azadeh Ensha, “A Case for Filling the iPhone 3G’s Power Vacuum,” Dated Nov. 27, 2008.*
- Joseph Flatley, “Incase Power Slider for iPhone 3G Doubles the Juice, Lets You Sync,” dated Nov. 17, 2008.*
- Otterbox Catalog, 2006.*
- Jeremy Horowitz, “PhoneSuit MiLi Power Pack for iPhone,” Jan. 29, 2009, <http://www.ilounge.com/index.php/reviews/entry/phonesuit-mili-power-pack-for-iphone/>.*

- Jeremy Horowitz, "FastMac TruePower iV Universal Battery Charger," Dec. 11, 2008, <http://www.ilounge.com/index.php/reviews/entry/fastmac-truepower-iv-universal-battery-charger/>.*
- Jeremy Horowitz, "Konnet PowerKZ Extended Power for iPhone," Apr. 2, 2009, <http://www.ilounge.com/index.php/reviews/entry/konnet-powerkz-extended-power-for-iphone/>.*
- Kanamori et al., "USB battery-charger designs meet new industry standards," EDN pp. 63-70, dated Feb. 21, 2008.*
- AVR458: Charging Lithium-Ion Batteries with ATAVRBC100, which appear to include a date of Aug. 2008.*
- Battery Charging Specification, dated Apr. 15, 2009.*
- BCM2033 Product Brief, 2 pages, dated Nov. 1, 2002.*
- "USB battery charger detector intelligently powers mobiles," Dec. 17, 2007, http://www.eetasia.com/ART_8800493819_765245_NP_10b171b6.HTMce#.*
- Ben Kaufman, "Behind the Invention: The mophie Juice Pack," dated Dec. 31, 2013, <https://medium.com/@benkaufman/behind-the-invention-the-mophie-juice-pack-a0620f74efcf>.*
- Mophie Relo Recharge, dated Feb. 7, 2006, <http://songslings.com/recharge.html>.*
- Case-Ari, LLC v. mStation, Inc.*, Case No. 1:2010-CV-01874 in the United States District Court for the Northern District of Georgia, filed Jun. 17, 2010.*
- Daniel Huang v. GC Technology, LLC*, Case No. CV10-4705 CAS (VBKx) in the United States District Court for the Central District of California, filed Jun. 24, 2010.*
- Hali-Power, Inc. v. mStation Corp.*, Case No. 1:2010-CV-00773 in the United States District Court for the Northern District of New York, filed Jun. 30, 2010.*
- Mophie, Inc. v. Loza & Loza, LLP*, Case No. SACV11-00539 DOC (MLGx) in the United States District Court for the Central District of California, filed Apr. 7, 2011.*
- Mophie's Complaint, filed Apr. 7, 2011 in *Mophie, Inc. v. Loza & Loza, LLP*, Case No. SACV11-00539 DOC (MLGx) in the United States District Court for the Central District of California.*
- Mophie, Inc. v. Foreign Trade Corporation*, Case No. 8:12-CV-00292-JST-RNB in the United States District Court for the Central District of California, filed Feb. 24, 2012.*
- Mophie, Inc. v. Kdlinks Inc.*, Case No. 2:2012-CV-02639 in the United States District Court for the Central District of California, filed Mar. 27, 2012.*
- Otter Products, LLC v. Mophie, LLC*, Case No. 1:2012-CV-01969 in the United States District Court for the District of Colorado, filed Jul. 27, 2012.*
- Mophie's Answer, filed Oct. 15, 2012 in *Otter Products, LLC v. Mophie, LLC*, Case No. 1:2012-CV-01969 in the United States District Court for the District of Colorado.*
- Otter's Motion for Summary Judgment of Infringement and Declaration in Support Thereof, filed May 13, 2013 in *Otter Products, LLC v. Mophie, LLC*, Case No. 1:2012-CV-01969 in the United States District Court for the District of Colorado.*
- Mophie's Opposition to Motion for Summary Judgment of Infringement, filed Jun. 6, 2013 in *Otter Products, LLC v. Mophie, LLC*, Case No. 1:2012-CV-01969 in the United States District Court for the District of Colorado.*
- Mophie's Claim Construction Brief, filed Jun. 14, 2013 in *Otter Products, LLC v. Mophie, LLC*, Case No. 1:2012-CV-01969 in the United States District Court for the District of Colorado.*
- Otter's Claim Construction Brief, filed Jun. 14, 2013 in *Otter Products, LLC v. Mophie, LLC*, Case No. 1:2012-CV-01969 in the United States District Court for the District of Colorado.*
- Mophie's Brief in Response to Otter's Claim Construction Brief, filed Jun. 24, 2013 in *Otter Products, LLC v. Mophie, LLC*, Case No. 1:2012-CV-01969 in the United States District Court for the District of Colorado.*
- Otter's Rebuttal Brief For Construction of Claim Terms and Declaration, filed Jun. 24, 2013 in *Otter Products, LLC v. Mophie, LLC*, Case No. 1:2012-CV-01969 in the United States District Court for the District of Colorado.*
- Otter's Reply in Support of Motion for Summary Judgment of Infringement, filed Jun. 24, 2013 in *Otter Products, LLC v. Mophie, LLC*, Case No. 1:2012-CV-01969 in the United States District Court for the District of Colorado.*
- Joint Claim Construction Statement, filed Jun. 26, 2013 in *Otter Products, LLC v. Mophie, LLC*, Case No. 1:2012-CV-01969 in the United States District Court for the District of Colorado.*
- Incase Designs, Inc. v. Mophie, Inc.*, Case No. 3:2013-CV-00602 in the United States District Court for the Northern District of California, filed Feb. 12, 2013.*
- Mophie's Amended Answer and Counterclaims, filed May 8, 2013 in *Incase Designs, Inc. v. Mophie, Inc.*, Case No. 3:2013-CV-00602 in the United States District Court for the Northern District of California.*
- Mophie's Opposition to Motion to Strike Amended Affirmative Defenses, Filed Jun. 12, 2013 in *Incase Designs, Inc. v. Mophie, Inc.*, Case No. 3:2013-CV-00602 in the United States District Court for the Northern District of California.*
- Mophie's Reply in Support of Motion to Stay and Supporting Declaration, filed Sep. 3, 2013 in *Incase Designs, Inc. v. Mophie, Inc.*, Case No. 3:2013-CV-00602 in the United States District Court for the Northern District of California.*
- Incase Designs, Inc. v. Mophie, Inc.*, Case No. 3:2013-CV-03356 in the United States District Court for the Northern District of California, filed Jul. 18, 2013.*
- Incase Designs, Corp. v. Mophie, Inc.*, Case No. 3:2013-CV-04314 in the United States District Court for the Northern District of California, filed Sep. 18, 2013.*
- Mophie Motion 1—To Be Accorded Benefit, filed Nov. 20, 2013 in Patent Interference No. 105,946(RES).*
- Declaration of John Feland, Ph.D, In Support of Mophie Motion 1 To Be Accorded Benefit, dated Nov. 20, 2013, in Patent Interference No. 105,946(RES).*
- Mophie Motion 2—For Judgment that Incase's Involved Claims Are Unpatentable, filed Nov. 20, 2013 in Patent Interference No. 105,946(RES).*
- Declaration of John Feland, Ph.D, in Support of Mophie Motion 2 For Judgement That Incase's Involved Claims Are Unpatentable, dated Nov. 20, 2013, in Patent Interference No. 105,946(RES).*
- Incuse Motion 1—Motion for Benefit, filed Nov. 20, 2013 in Patent Interference No. 105,946(RES).*
- Incuse Motion 2—Motion To Undesignate Claims, filed Nov. 20, 2013 in Patent Interference No. 105,946(RES).*
- Incuse Motion 3—Motion For Judgment Based on Lack of Written Description, filed Nov. 20, 2013 in Patent Interference No. 105,946(RES).*
- Incuse Motion 4—Motion For Unpatentability of Mophie Claims, filed Nov. 20, 2013 in Patent Interference No. 105,946(RES).*
- Declaration of Andrew Wolfe, filed Nov. 20, 2013 in Patent Interference No. 105,946(RES).*
- Declaration of Thomas Overthun, filed Nov. 20, 2013 in Patent Interference No. 105,946(RES).*
- Declaration of Gabriel Dan, filed Nov. 20, 2013 in Patent Interference No. 105,946(RES).*
- Mophie's Third Amended Complaint, filed Jun. 27, 2014, in *Mophie, Inc. v. Source Vista*, Case No. 8:13-CV-01321 in the United States District Court for the Central District of California.*
- LivingSocial's Answer to Mophie's Fifth Amended Complaint and Counterclaims, filed Sep. 24, 2014, in *Mophie, Inc. v. Source Vista*, Case No. 8:13-CV-01321 in the United States District Court for the Central District of California.*
- Shah's Answer, Affirmative Defenses, and Counterclaims to Plaintiff's Fifth Amended Complaint, filed Sep. 24, 2014, in *Mophie, Inc. v. Source Vista*, Case No. 8:13-CV-01321 in the United States District Court for the Central District of California.*
- Expert Report of Dr. David Munson, dated Aug. 28, 2014, in *Mophie, Inc. v. Source Vista*, Case No. 8:13-CV-01321 in the United States District Court for the Central District of California.*
- Expert Report of John Feland, Ph.D, dated Aug. 28, 2014, in *Mophie, Inc. v. Source Vista*, Case No. 8:13-CV-01321 in the United States District Court for the Central District of California.*
- Rebuttal Expert Report of John Feland, Ph.D, dated Sep. 25, 2014, in *Mophie, Inc. v. Source Vista*, Case No. 8:13-CV-01321 in the United States District Court for the Central District of California.*
- Rebuttal Expert Report of Dr. David Munson, dated Sep. 25, 2014, in *Mophie, Inc. v. Source Vista*, Case No. 8:13-CV-01321 in the United States District Court for the Central District of California.*

Mophie's Second Amended Response to LivingSocial's Interrogatory No. 1121], dated Aug. 28, 2014, in *Mophie, Inc. v. Source Vista*, Case No. 8:13-CV-Q1321 in the United States District Court for the Central District of California.*

Mophie's Second Amended Response to Serve Global's Interrogatory No. 2, dated Aug. 28, 2014, in *Mophie, Inc. v. Source Vista*, Case No. 8:13-CV-01321 in the United States District Court for the Central District of California.*

Defendant's Memorandum in Support of Motion for Partial Summary Judgment, dated Sep. 23, 2014, in *Mophie, Inc. v. Source Vista*, Case No. 8:13-CV-01321 in the United States District Court for the Central District of California.*

Declaration of David Munson in Support of Defendant's Motion for Partial Summary Judgment, dated Sep. 22, 2014, in *Mophie, Inc. v. Source Vista*, Case No. 8:13-CV-01321 in the United States District Court for the Central District of California.*

John Feland, Ph.D. Deposition Transcript, dated Sep. 30, 2014, in *Mophie, Inc. v. Source Vista*, Case No. 8:13-CV-01321 in the United States District Court for the Central District of California.*

Matthew Brand Deposition Transcript, dated Jul. 23, 2014, in *Mophie, Inc. v. Source Vista*, Case No. 8:13-CV-01321 in the United States District Court for the Central District of California.*

Dharmesh Shah Deposition Transcript, dated Jul. 11, 2014, in *Mophie, Inc. v. Source Vista*, Case No. 8:13-CV-01321 in the United States District Court for the Central District of California.*

Defendants' Statement of Uncontroverted Material Fact and Contentions of Law, filed Sep. 22, 2014 in *Mophie, Inc. v. Source Vista*, Case No. 8:13-CV-01321 in the United States District Court for the Central District of California.*

Memorandum of Points and Authorities in Support of Mophie's Motion for Summary Judgment, filed Sep. 22, 2014, in *Mophie, Inc. v. Source Vista*, Case No. 8:13-CV-01321 in the United States District Court for the Central District of California.*

Statement of Uncontroverted Facts and Conclusions of Law in Support of Mophie's Motion for Summary Judgment, filed Sep. 22, 2014, in *Mophie, Inc. v. Source Vista*, Case No. 8:13-CV-01321 in the United States District Court for the Central District of California.*

Mophie's Opposition to Shah and Serve Global's Motion for Partial Summary Judgment, dated Oct. 3, 2014, in *Mophie, Inc. v. Source Vista*, Case No. 8:13-CV-01321 in the United States District Court for the Central District of California.*

Statement of Genuine Disputes of Material Fact in Opposition to Shah and Serve Global's Motion for Partial Summary Judgment, filed Oct. 3, 2014, in *Mophie, Inc. v. Source Vista*, Case No. 8:13-CV-01321 in the United States District Court for the Central District of California.*

Opposition of LivingSocial to Mophie's Motion for Summary Judgment, dated Oct. 3, 2014, in *Mophie, Inc. v. Source Vista*, Case No. 8:13-CV-01321 in the United States District Court for the Central District of California.*

Defendants' Opposition to Plaintiffs Motion for Summary Judgment, filed Oct. 3, 2014, in *Mophie, Inc. v. Source Vista*, Case No. 8:13-CV-01321 in the United States District Court for the Central District of California.*

Defendants' Response to Plaintiffs Statement of Uncontroverted Material Fact and Contentions of Law, filed Oct. 3, 2014, in *Mophie, Inc. v. Source Vista*, Case No. 8:13-CV-01321 in the United States District Court for the Central District of California.*

David Munson Deposition Transcript, dated Sep. 29, 2014, in *Mophie, Inc. v. Source Vista*, Case No. 8:13-CV-01321 in the United States District Court for the Central District of California.*

Mophie's First Amended Complaint, filed Jun. 25, 2014, in *Mophie, Inc. v. UNU Electronics Inc.*, Case No. 8:13-CV-01705 in the United States District Court for the Central District of California.*

UNU's Answer and Counterclaims, filed Jul. 10, 2014, in *Mophie, Inc. v. UNU Electronics Inc.*, Case No. 8:13-CV-01705 in the United States District Court for the Central District of California.*

Mophie's Responses to Defendant's Third Set of Interrogatories (No. 12), dated Aug. 21, 2014, in *Mophie, Inc. v. UNU Electronics Inc.*, Case No. 8:13-CV-01705 in the United States District Court for the Central District of California.*

Mophie's Responses to Defendant's First set of Requests for Admissions (Nos. 1-46), dated Aug. 19, 2014, *Mophie, Inc. v. UNU Electronics Inc.*, Case No. 8:13-CV-01705 in the United States District Court for the Central District of California.*

Mophie's Responses to Defendant's Second set of Requests for Admissions (Nos. 47-109), dated Aug. 19, 2014, in *Mophie, Inc. v. UNU Electronics Inc.*, Case No. 8:13-CV-01705 in the United States District Court for the Central District of California.*

Request for Ex Parte Reexamination of U.S. Pat. No. 8,367,235, filed Aug. 14, 2014.*

Corrected Request for Ex Parte Reexamination of U.S. Pat. No. 8,367,235, filed Sep. 18, 2014.*

Declaration of John Feland, Ph.D. In Support of Mophie's Opposition to Defendants Motion for Partial Summary Judgment, filed Oct. 3, 2014, in *Mophie, Inc. v. Source Vista*, Case No. 8:13-CV-01321 in the United States District Court for the Central District of California.*

LivingSocial's Reply in Support of Motion for Summary Judgment, Filed Oct. 10, 2014, in *Mophie, Inc. v. Source Vista*, Case No. 8:13-CV-01321 in the United States District Court for the Central District of California.*

Defendants' Reply in Support of Motion for Partial Summary Judgment, Filed Oct. 10, 2014, in *Mophie, Inc. v. Source Vista*, Case No. 8:13-CV-01321 in the United States District Court for the Central District of California.*

Reply in Support of Mophie's Motion for Summary Judgment, Filed Oct. 10, 2014, in *Mophie, Inc. v. Source Vista*, Case No. 8:13-CV-01321 in the United States District Court for the Central District of California.*

Mophie's Reply to Counterclaims of LivingSocial, filed Oct. 14, 2014, in *Mophie, Inc. v. Source Vista*, Case No. 8:13-CV-01321 in the United States District Court for the Central District of California.*

Mophie's Reply to Counterclaims of Shah, filed Oct. 14, 2014, in *Mophie, Inc. v. Source Vista*, Case No. 8:13-CV-01321 in the United States District Court for the Central District of California.*

Defendant's Response to Mophie's Fourth Set of Interrogatories, dated Sep. 23, 2014, in *Mophie, Inc. v. UNU Electronics Inc.*, Case No. 8:13-CV-01705 in the United States District Court for the Central District of California.*

Plaintiff Mophie's Preliminary Claim Constructions and Identification of Extrinsic Evidence, dated Oct. 14, 2014, in *Mophie, Inc. v. UNU Electronics Inc.*, Case No. 8:13-CV-01705 in the United States District Court for the Central District of California.*

Defendant's Preliminary Claim Constructions and Extrinsic Evidence, dated Oct. 14, 2014, in *Mophie, Inc. v. UNU Electronics Inc.*, Case No. 8:13-CV-01705 in the United States District Court for the Central District of California.*

Plaintiff Mophie's Opening Brief on Claim Construction, filed Oct. 29, 2014, in *Mophie, Inc. v. UNU Electronics Inc.*, Case No. 8:13-CV-01705 in the United States District Court for the Central District of California.*

Declaration of John Feland, Ph.D. In Support of Plaintiffs Preliminary Claim Constructions, filed Oct. 29, 2014, in *Mophie, Inc. v. UNU Electronics Inc.*, Case No. 8:13-CV-01705 in the United States District Court for the Central District of California.*

Supplemental Declaration of John Feland, Ph.D. in Support of Plaintiffs Claim Constructions, filed Oct. 29, 2014, *Mophie, Inc. v. UNU Electronics Inc.*, Case No. 8:13-CV-01705 in the United States District Court for the Central District of California.*

Declaration of Sheila N. Swaroop in Support of Mophie's Opening Claim Construction Brief, filed Oct. 29, 2014, in *Mophie, Inc. v. UNU Electronics Inc.*, Case No. 8:13-CV-01705 in the United States District Court for the Central District of California.*

Transcript of Deposition of John Feland, dated Oct. 21, 2014, in *Mophie, Inc. v. UNU Electronics Inc.*, Case No. 8:13-CV-01705 in the United States District Court for the Central District of California.*

Defendant's Opening Claim Construction Brief, dated Oct. 29, 2014, in *Mophie, Inc. v. UNU Electronics Inc.*, Case No. 8:13-CV-01705 in the United States District Court for the Central District of California.*

Order Granting Request for Ex Parte Reexamination of U.S. Pat. No. 8,367,235, in Reexamination Control No. U.S. Appl. No. 90/013,319, dated Oct. 24, 2014.*

Order Re LivingSocial's Motion for Summary Judgment, Mophie's Motion for Summary Judgment, Source Vista and Shah's Motion for Partial Summary Judgment, and Mophie's Motion to Bifurcate, dated Nov. 12, 2014, in *Mophie, Inc. v. Source Vista*, Case No. 8:13-CV-01321 in the United States District Court for the Central District of California.*

Mophie's Memorandum in Support of its Motion for Reconsideration, filed Nov. 19, 2014, in *Mophie, Inc. v. Source Vista*, Case No. 8:13-CV-01321 in the United States District Court for the Central District of California.*

Declaration of Sheila N. Swaroop in Support of Mophie's Motion for Reconsideration, filed Nov. 19, 2014, in *Mophie, Inc. v. Source Vista*, Case No. 8:13-CV-01321 in the United States District Court for the Central District of California.*

Order Denying Plaintiff's Motion for Reconsideration, dated Nov. 21, 2014, in *Mophie, Inc. v. Source Vista*, Case No. 8:13-CV-01321 in the United States District Court for the Central District of California.*

Defendants Dharmesh Shah and Serve Global, LLC's Memorandum of Points and Authorities in Support of Defendants's Motion for Attorney's Fees, filed Mar. 21, 2015, in *Mophie, Inc. v. Source Vista*, Case No. 8:13-CV-01321 in the United States District Court for the Central District of California.*

Memorandum of Points and Authorities in Support of LivingSocial, Inc.'s Motion for Legal Fees and Costs, filed Mar. 20, 2015, in *Mophie, Inc. v. Source Vista*, Case No. 8:13-CV-01321 in the United States District Court for the Central District of California.*

Plaintiff Mophie, Inc.'s Opposition to Defendants Dharmesh Shah and Serve Global, LLC's Motion for Attorneys' Fees, filed Apr. 3, 2015, in *Mophie, Inc. v. Source Vista*, Case No. 8:13-CV-01321 in the United States District Court for the Central District of California.*

Plaintiff Mophie, Inc.'s Opposition to Defendant LivingSocial, Inc.'s Motion for Attorneys' Fees, filed Apr. 3, 2015, in *Mophie, Inc. v. Source Vista*, Case No. 8:13-CV-01321 in the United States District Court for the Central District of California.*

Reply to Plaintiffs Opposition to Defendants Dharmesh Shah and Serve-Global, LLC's Motion for Attorney's Fees, filed Apr. 10, 2015, in *Mophie, Inc. v. Source Vista*, Case No. 8:13-CV-01321 in the United States District Court for the Central District of California.*

Reply in Support of LivingSocial, Inc.'s Motion for Legal Fees and Costs, filed Apr. 10, 2015, in *Mophie, Inc. v. Source Vista*, Case No. 8:13-CV-01321 in the United States District Court for the Central District of California.*

Amended Final Judgment and Permanent Injunction, dated Dec. 11, 2015, in *Mophie, Inc. v. Source Vista*, Case No. 8:13-CV-01321 in the United States District Court for the Central District of California.*

Order Re Motions for Attorneys' Fees, Motion to Amend Permanent Injunction, Motions for Judgment as a Matter of Law, Motion for Relief From Judgment, and Motion for New Trial, dated Dec. 11, 2015, in *Mophie, Inc. v. Source Vista*, Case No. 8:13-CV-01321 in the United States District Court for the Central District of California.*

Mophie's Complaint, filed Dec. 16, 2015, in *Mophie, Inc. v. Cute Mobile Inc.*, Case No. 8:15-cv-02086 in the United States District Court for the Central District of California.*

Daniel Huang Deposition Transcript (Redacted) with Exhibit 121, dated Aug. 21, 2014, in *Mophie, Inc. v. Source Vista*, Case No. 8:13-CV-01321 in the United States District Court for the Central District of California.*

Mophie's First Amended Complaint, filed May 25, 2016 in *Mophie, Inc. v. Cute Mobile Inc.*, Case No. 8:15-cv-02086 in the United States District Court for the Central District of California.*

Mophie Juice Pack iPhone 3G User Manual—Retrieved from http://static3.shopify.com/s/files/1/0008/4942/assets/mophiejuicepack_3G_manual_rl.pdf on Apr. 10, 2009.*

AVR458: Charging Lithium-Ion Batteries with ATAVRBC100, which appear to include a date of Aug. 8.*

Mophie's Responses to Defendant's First set of Requests for Admissions (Nos. 1-46), dated Aug. 19, 2014, in *Mophie, Inc. v. UNU Electronics Inc.*, Case No. 8:13-CV-01705 in the United States District Court for the Central District of California.*

Supplemental Declaration of John Feland, Ph.D. in Support of Plaintiffs Claim Constructions, filed Oct. 29, 2014, in *Mophie, Inc. v. UNU Electronics Inc.*, Case No. 8:13-CV-01705 in the United States District Court for the Central District of California.*

The best iPhone 6 and iPhone 6 Plus battery Cases, posting date Jun. 12, 2015, [online][site visited May 29, 2018] &URL: <https://www.engadget.com/2015/06/12/the-best-iphone-6-and-iphone-6-plus-battery-case/>; (Year: 2015).*

The 10 best iPhone 6 extended battery cases to keep the power flowing, posting date Jul. 23, 2015, [online][site visited May 29, 2018]&URL:<https://www.digitaltrends.com/mobile/best-iphone-6-battery-cases/>; (Year: 2015).*

Reexamination Control U.S. Appl. No. 90/013,319, filed Sep. 18, 2014, Huang et al.

U.S. Appl. No. 15/130,196, filed Apr. 15, 2016, Huang.

U.S. Appl. No. 29/382,515, filed Jan. 4, 2011, Gallouzi et al.

U.S. Appl. No. 29/464,620, filed Aug. 19, 2013, Tsai.

U.S. Appl. No. 29/478,391, filed Jan. 3, 2014, Namminga et al.

U.S. Appl. No. 29/478,390, filed Jan. 3, 2014, Dang et al.

U.S. Appl. No. 29/478,383, filed Jan. 3, 2014, Dang et al.

U.S. Appl. No. 29/478,388, filed Jan. 3, 2014, Kim et al.

U.S. Appl. No. 29/499,868, filed Aug. 19, 2014, Mophie, Inc.

U.S. Appl. No. 29/539,419, filed Sep. 14, 2015, Dang et al.

U.S. Appl. No. 29/528,266, filed May 27, 2015, Gjøvik et al.

U.S. Appl. No. 29/534,901, filed Jul. 31, 2015, Dang et al.

U.S. Appl. No. 15/223,683, filed Jul. 29, 2016, Huang et al.

U.S. Appl. No. 15/223,735, filed Jul. 29, 2016, Diebel et al.

U.S. Appl. No. 29/556,805, filed Mar. 3, 2016, Dang et al.

U.S. Appl. No. 29/556,807, filed Mar. 3, 2016, Dang et al.

U.S. Appl. No. 29/626,999, filed Nov. 21, 2017, DiLella.

U.S. Appl. No. 29/556,809, filed Mar. 3, 2016, Dang et al.

U.S. Appl. No. 16/132,272, filed Sep. 14, 2018, Huang et al.

U.S. Appl. No. 29/668,743, filed Nov. 1, 2018, Dang et al.

U.S. Appl. No. 29/668,770, filed Nov. 1, 2018, Dang et al.

U.S. Appl. No. 29/668,768, filed Nov. 1, 2018, Dang et al.

U.S. Appl. No. 29/668,774, filed Nov. 1, 2018, Dang et al.

U.S. Appl. No. 29/668,773, filed Nov. 1, 2018, Dang et al.

U.S. Appl. No. 29/668,766, filed Nov. 1, 2018, Dang et al.

U.S. Appl. No. 16/235,185, filed Dec. 28, 2018, Huang et al.

U.S. Appl. No. 29/675,984, filed Jan. 7, 2019, Dang et al.

U.S. Appl. No. 29/675,991, filed Jan. 7, 2019, Dang et al.

U.S. Appl. No. 29/675,993, filed Jan. 7, 2019, Dang et al.

Simon Hill, "The 10 Best iPhone 6 Extended Battery Cases to Keep the Power Flowing", Digital Trends, posted Jul. 23, 2015, accessed May 29, 2018, <https://www.digitaltrends.com/mobile/best-iphone-6-battery-cases/>.

"The Best iPhone 6 and iPhone 6 Plus Battery Cases", Engadget, posted Jun. 12, 2015, accessed May 29, 2018, <https://www.engadget.com/2015/06/12/the-best-iphone-6-and-iphone-6-plus-battery-case/>.

Amazon.com, "Galaxy S6 Battery Case, i-Blason External Protective Battery Case/Cover for Samsung Galaxy S6 2015 Release." Customer Review published Mar. 29, 2015. Retrieved from internet at <http://www.amazon.com/Case-i-Blason-External-Protective-Versions/dp/B00SNS4LME>, Apr. 28, 2016. 7 pages.

Andrew Martonik, "Samsung Galaxy S7 Wireless Charging Battery Pack review," dated Apr. 22, 2016.

Simon Hill, "Incipio's Offgrid Galaxy S7 Edge case boosts battery life and supports wireless charging," dated Sep. 18, 2016.

* cited by examiner

Primary Examiner — L. A. Grabenstetter
(74) *Attorney, Agent, or Firm* — Knobbe, Martens, Olson
& Bear, LLP

(57) **CLAIM**

The ornamental design for a case for a mobile electronic device, as shown and described.

DESCRIPTION

FIG. 1 is a top-front perspective view of a first embodiment of the design for a case for a mobile electronic device in a closed configuration;
FIG. 2 is a bottom-rear perspective view thereof;
FIG. 3 is a front view thereof;
FIG. 4 is a rear view thereof;
FIG. 5 is a left-side view thereof;
FIG. 6 is a right-side view thereof;
FIG. 7 is a top view thereof;
FIG. 8 is a bottom view thereof;
FIG. 9 is a top-front perspective view of the first embodiment of the design for a case for a mobile electronic device in an open configuration;
FIG. 10 is a bottom-rear perspective view thereof;
FIG. 11 is a front view thereof;
FIG. 12 is a rear view thereof;
FIG. 13 is a left-side view thereof;

FIG. 14 is a right-side view thereof;
FIG. 15 is a top view thereof; and
FIG. 16 is a bottom view thereof.
FIG. 17 is a top-front perspective view of a second embodiment of the design for a case for a mobile electronic device in a closed configuration;
FIG. 18 is a bottom-rear perspective view thereof;
FIG. 19 is a front view thereof;
FIG. 20 is a rear view thereof;
FIG. 21 is a left-side view thereof;
FIG. 22 is a right-side view thereof;
FIG. 23 is a top view thereof;
FIG. 24 is a bottom view thereof;
FIG. 25 is a top-front perspective view of the second embodiment of the design for a case for a mobile electronic device in an open configuration;
FIG. 26 is a bottom-rear perspective view thereof;
FIG. 27 is a front view thereof;
FIG. 28 is a rear view thereof;
FIG. 29 is a left-side view thereof;
FIG. 30 is a right-side view thereof;
FIG. 31 is a top view thereof; and,
FIG. 32 is a bottom view thereof.
The broken line portions in the drawings are shown to illustrate environment only and form no part of the claimed design.

1 Claim, 24 Drawing Sheets

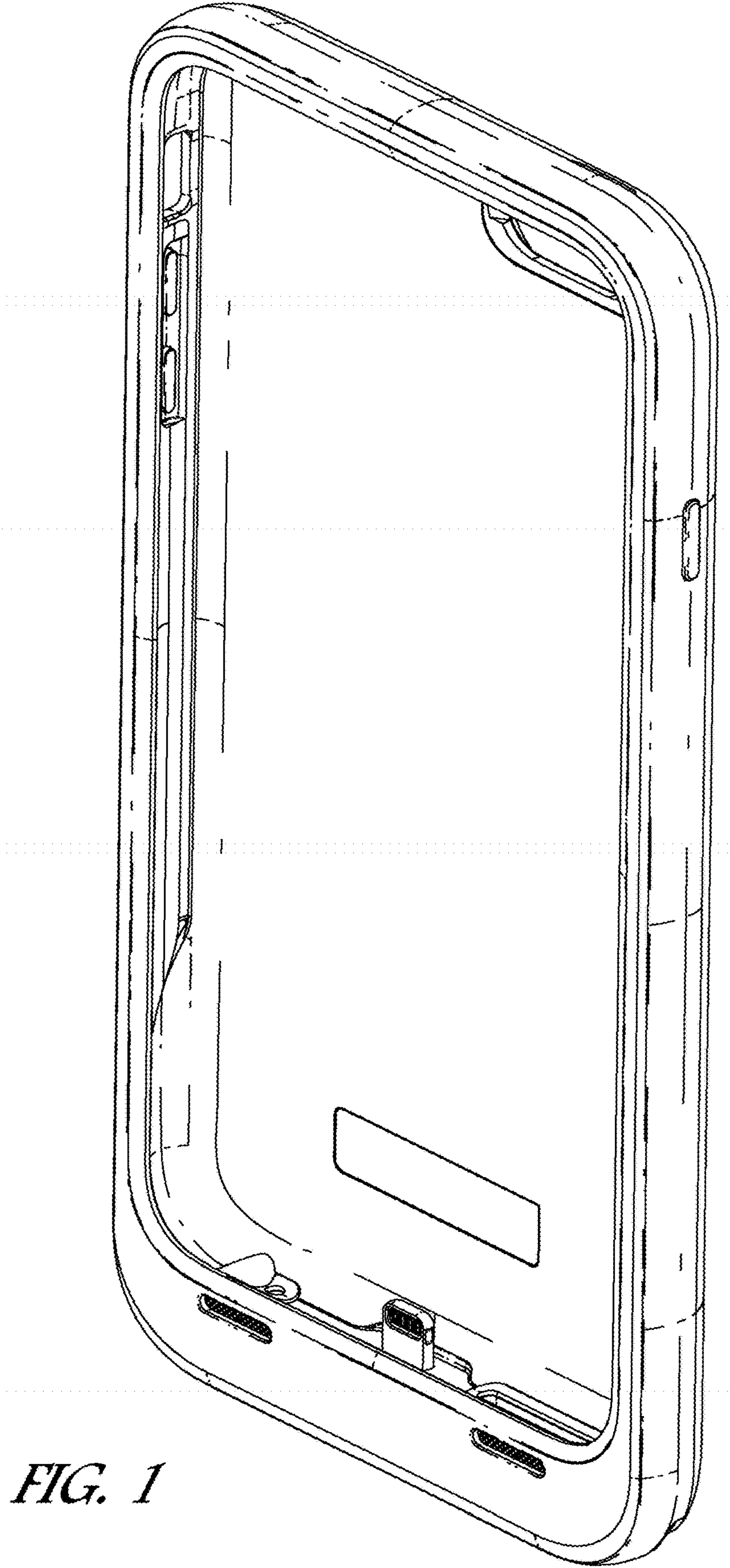

FIG. 1

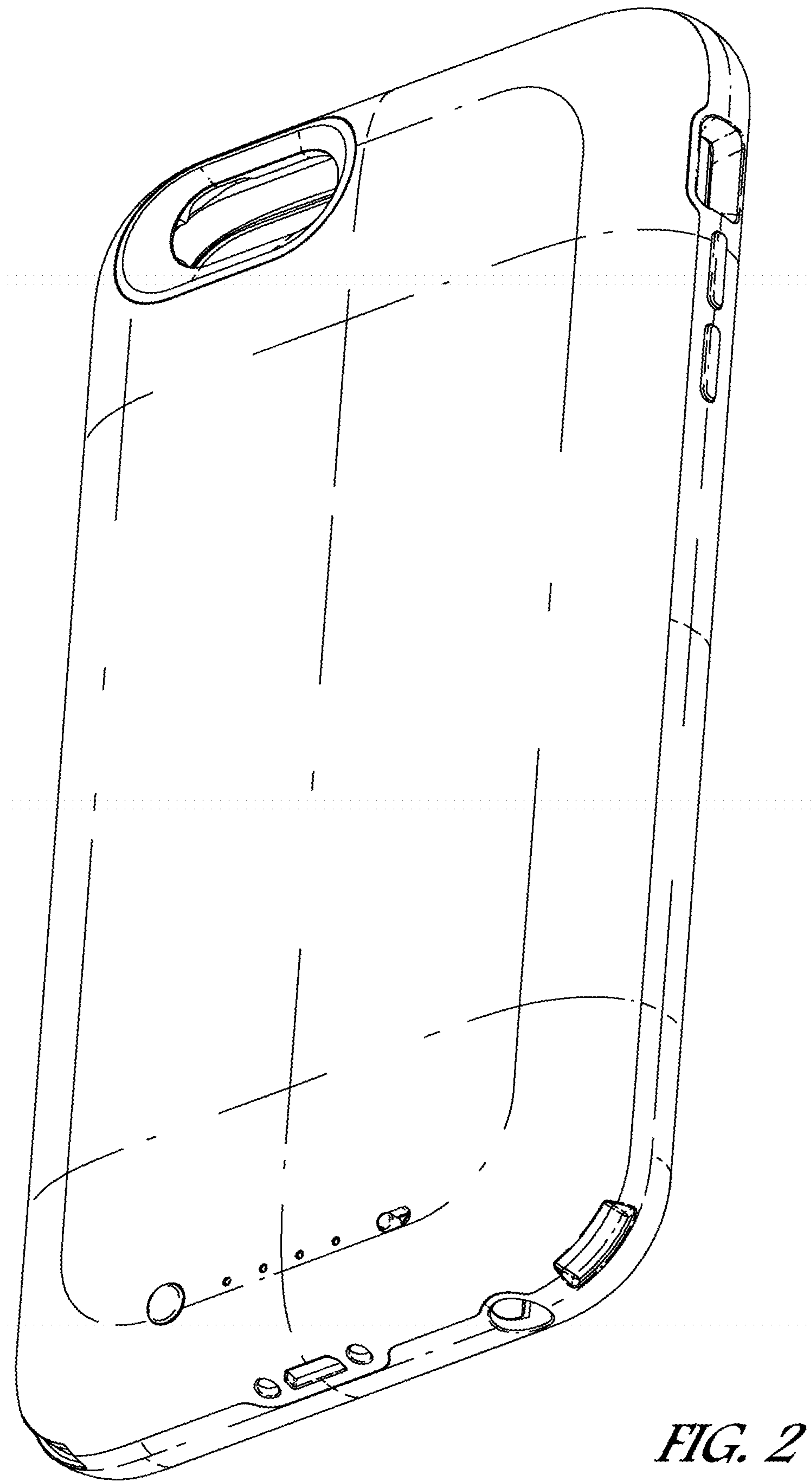

FIG. 2

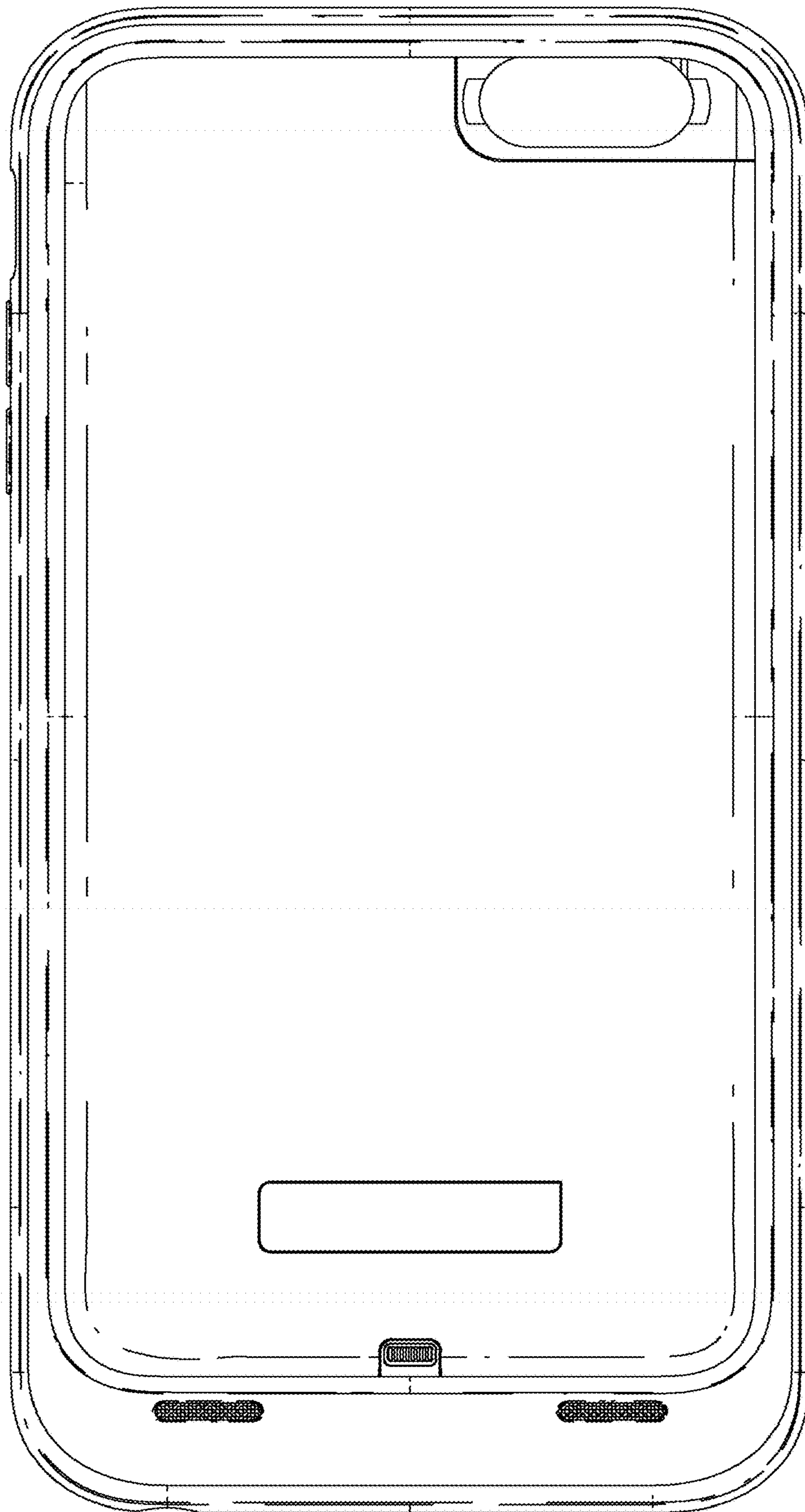

FIG. 3

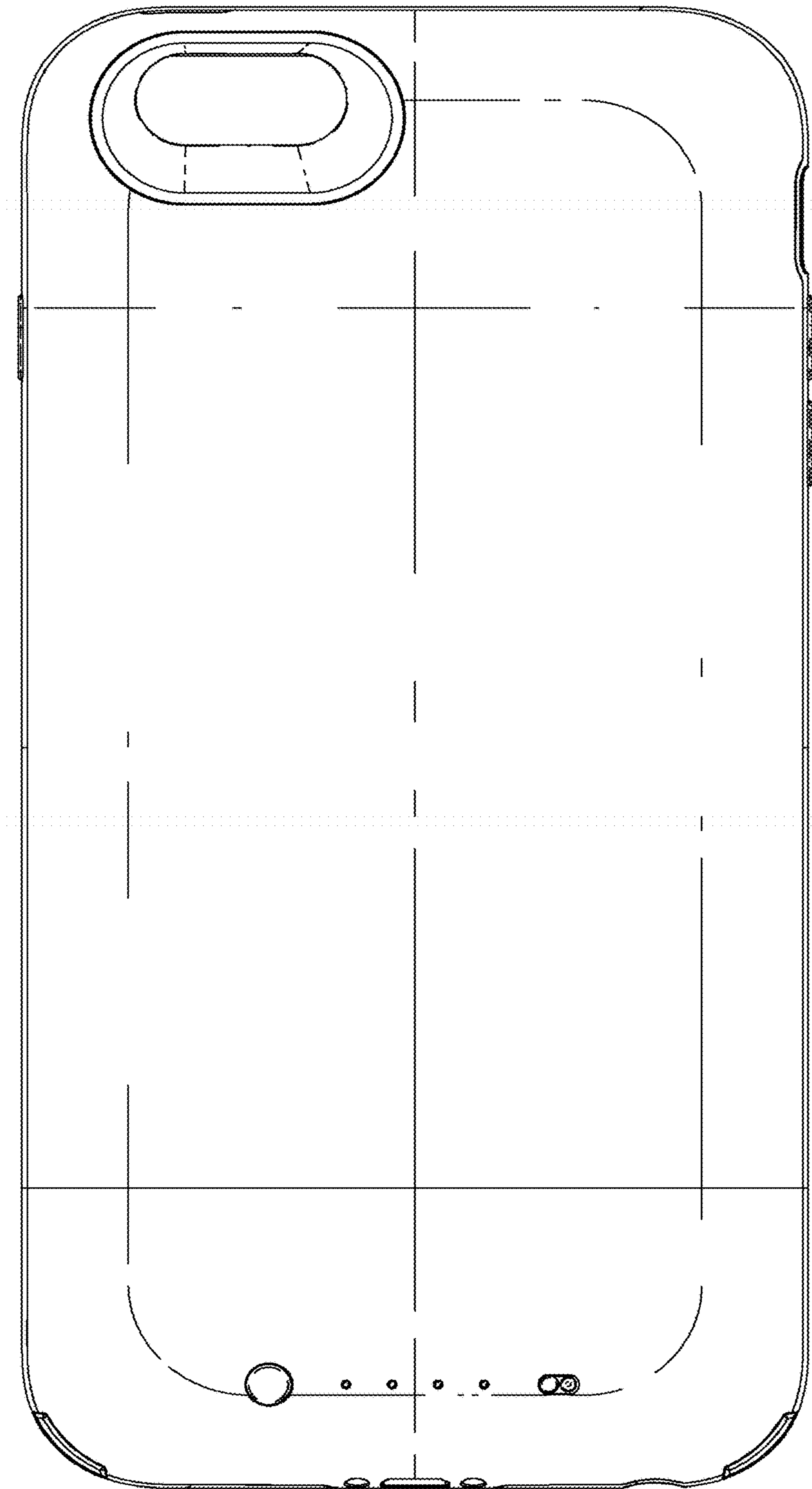

FIG. 4

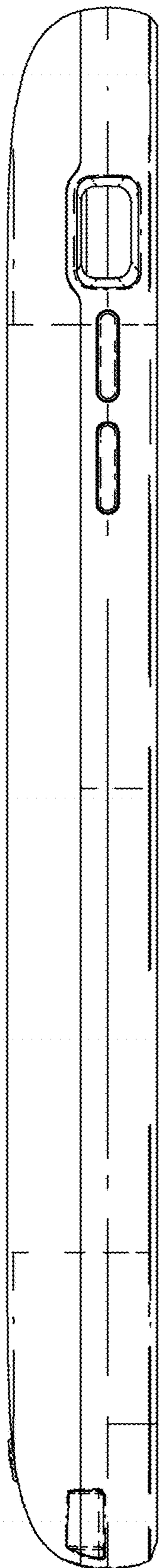

FIG. 5

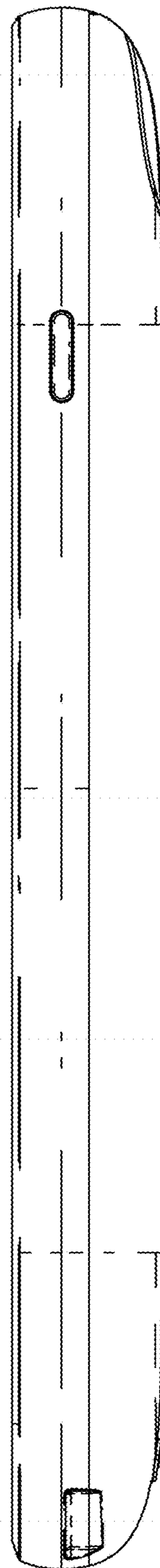

FIG. 6

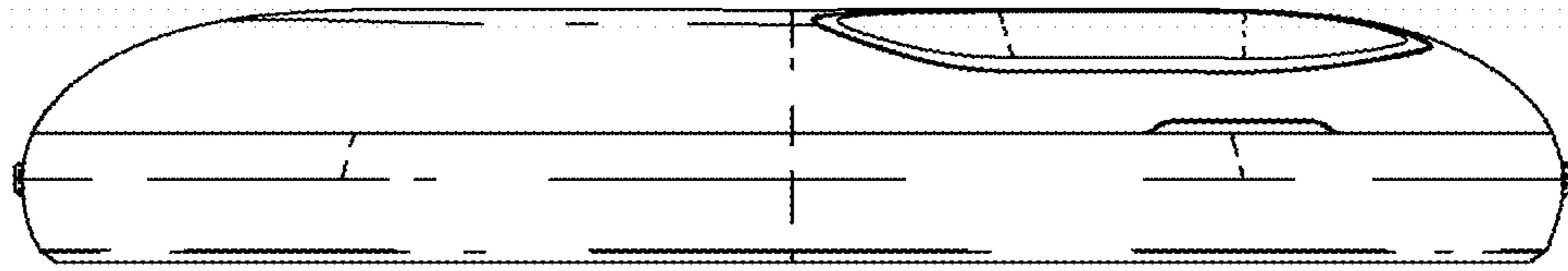

FIG. 7

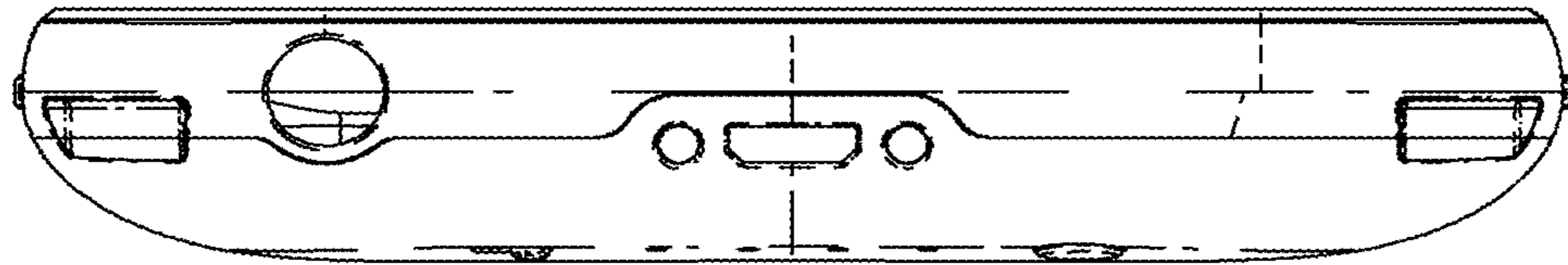

FIG. 8

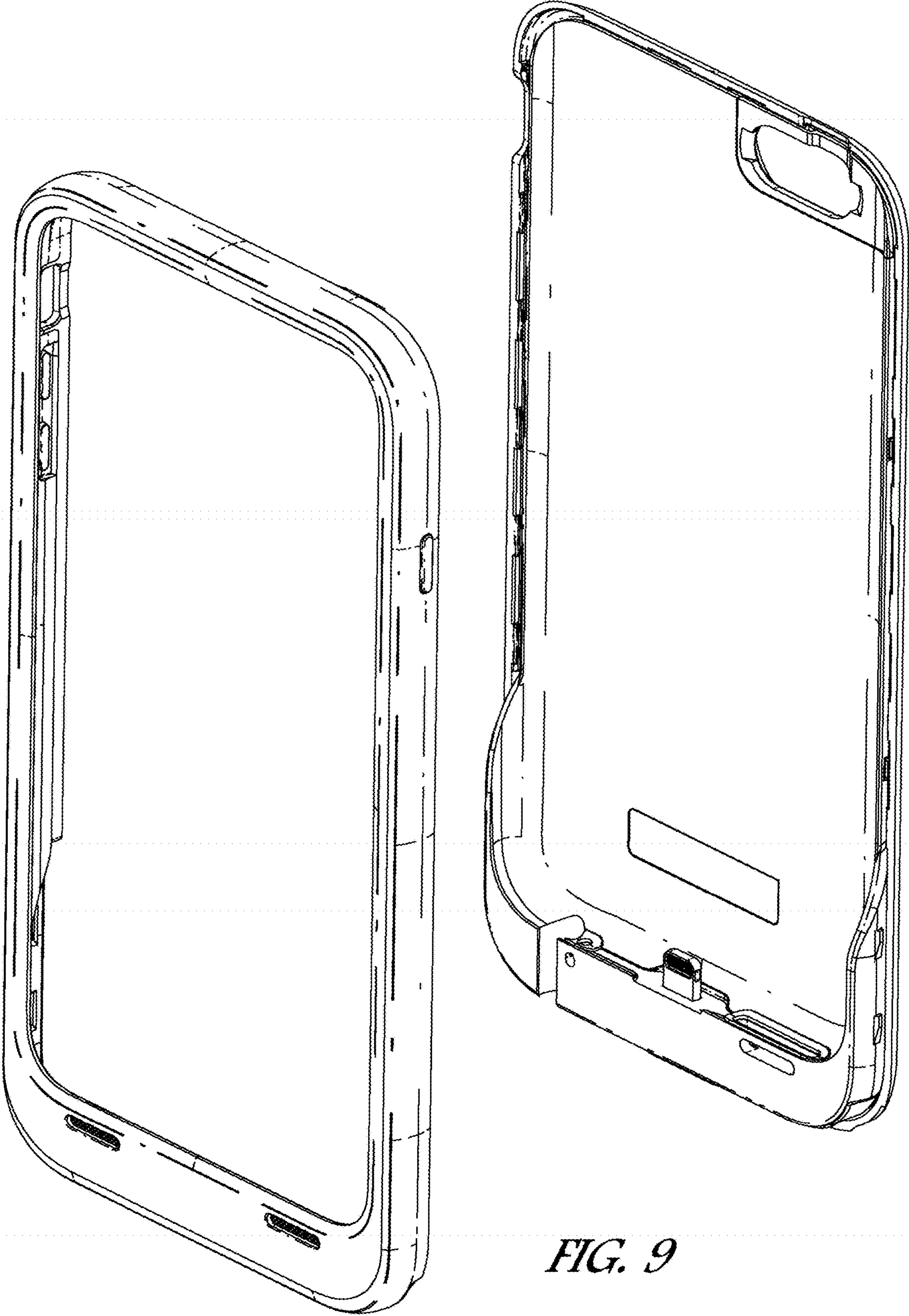

FIG. 9

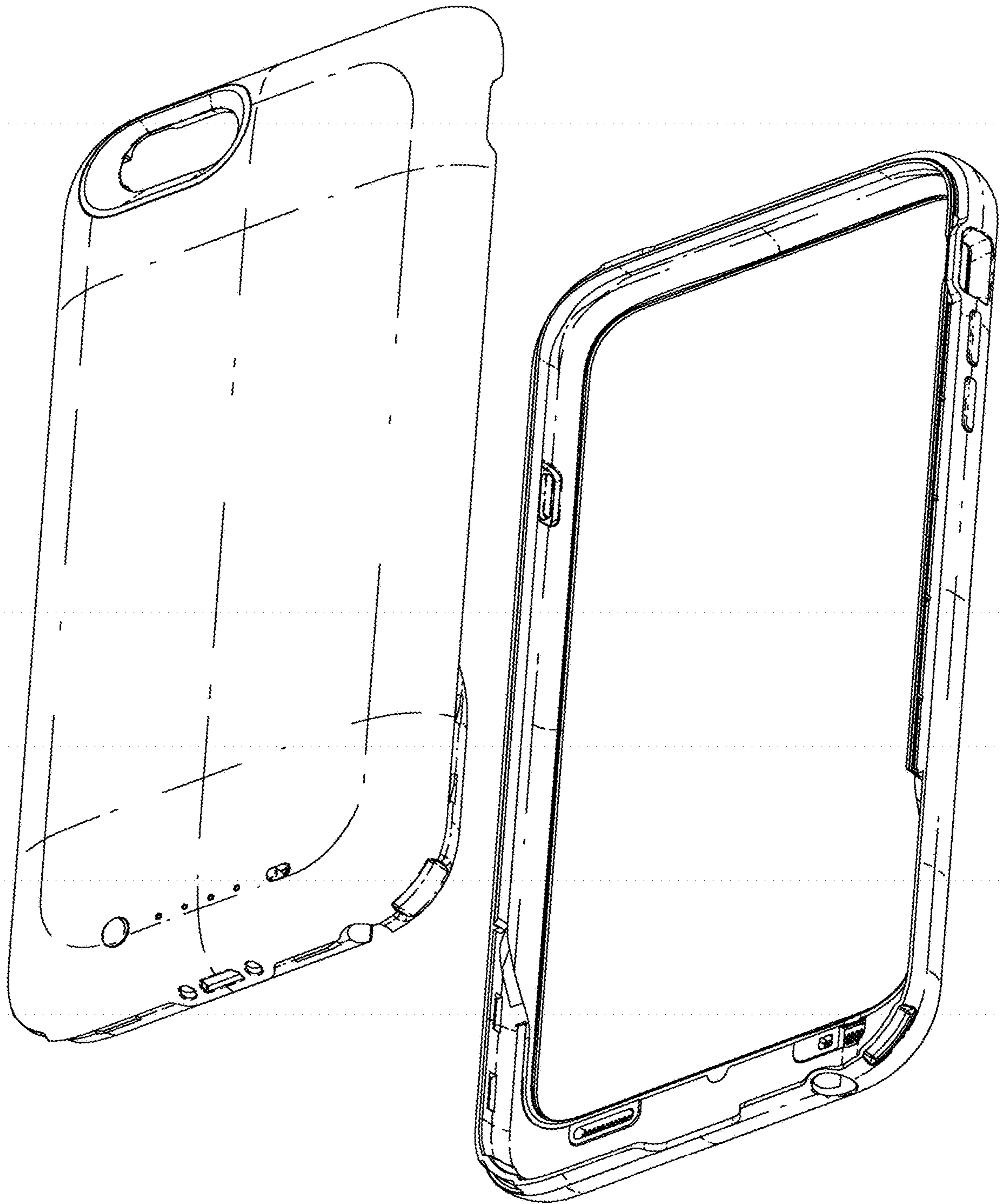

FIG. 10

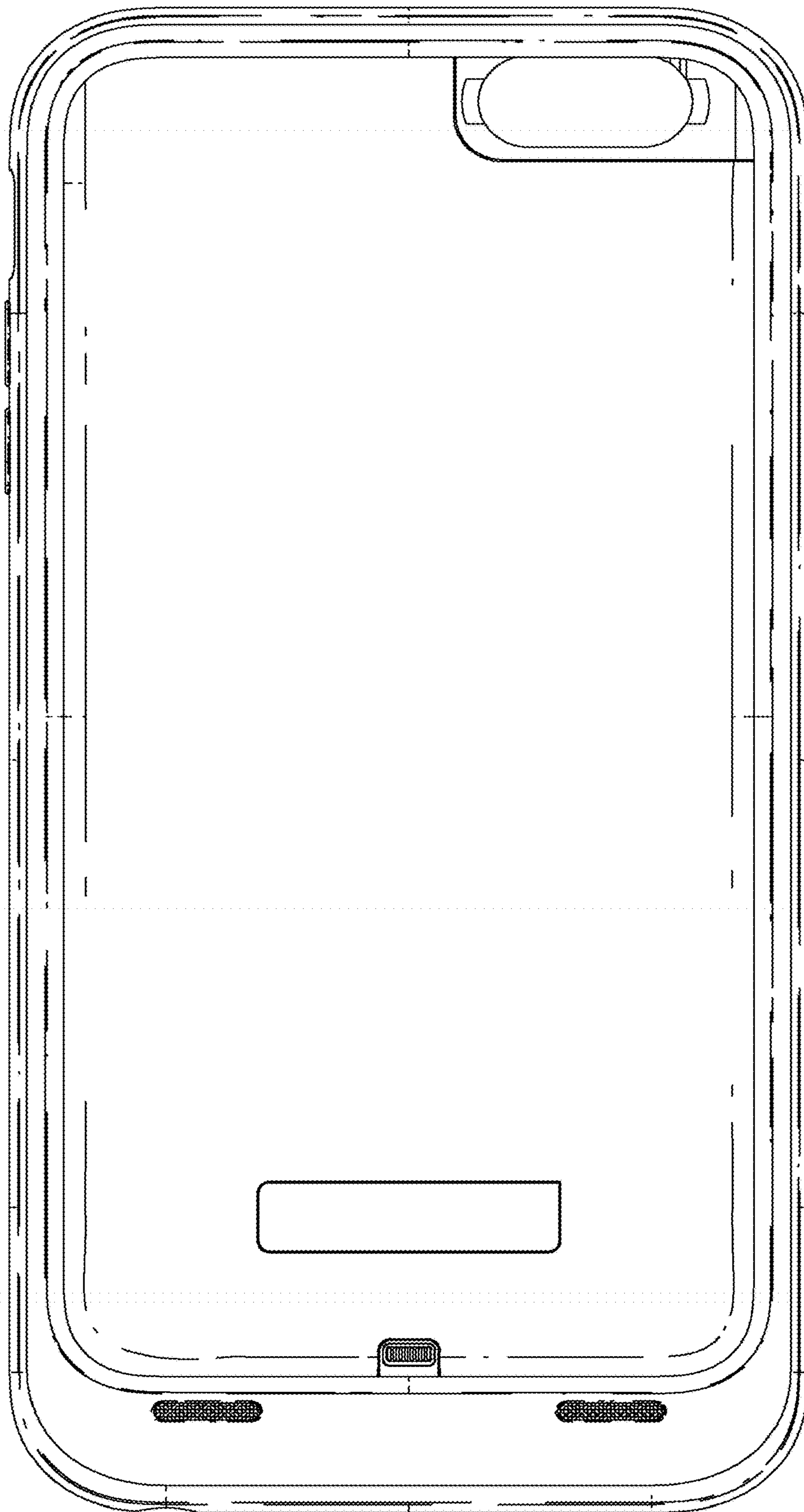

FIG. 11

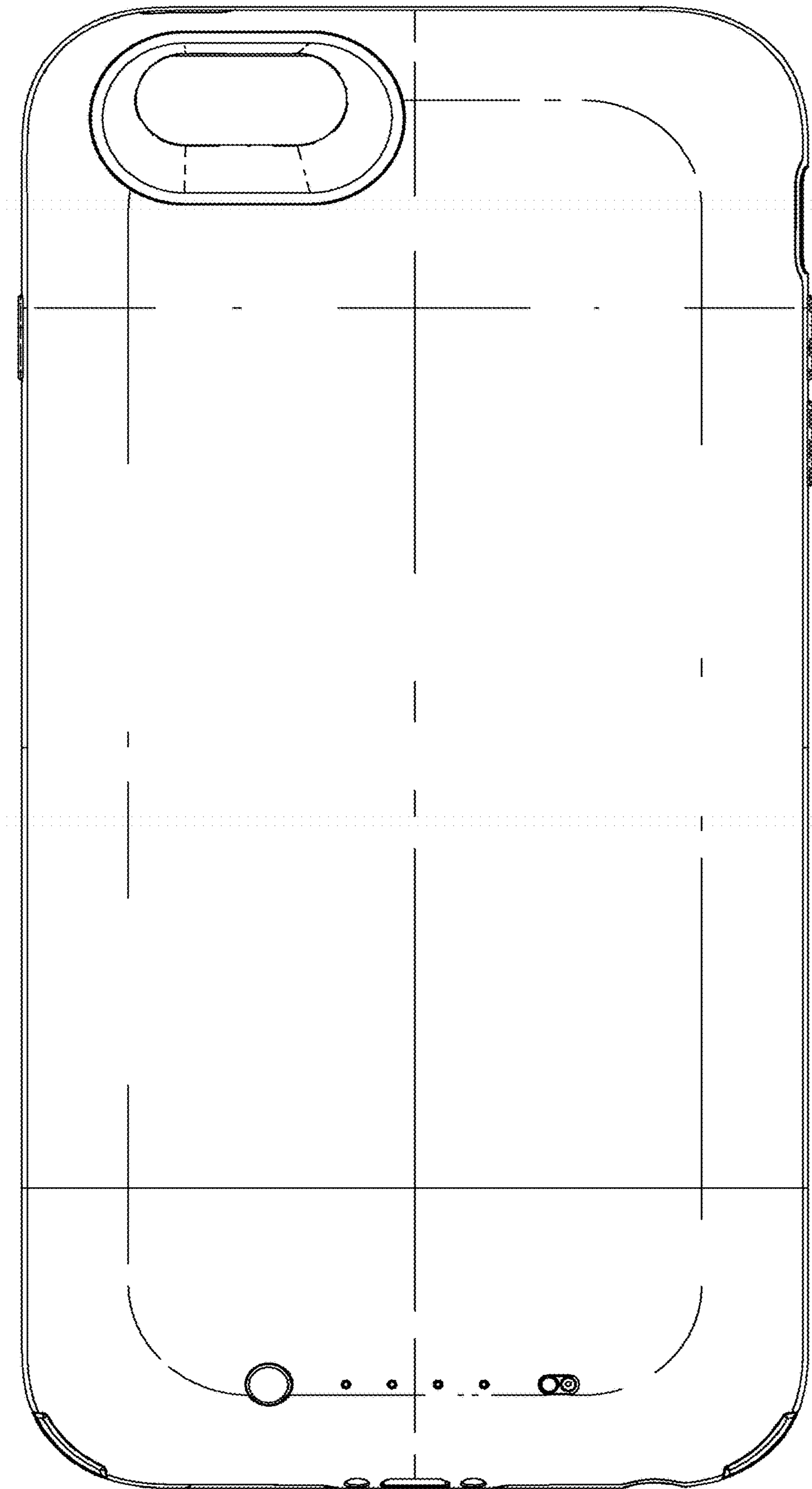

FIG. 12

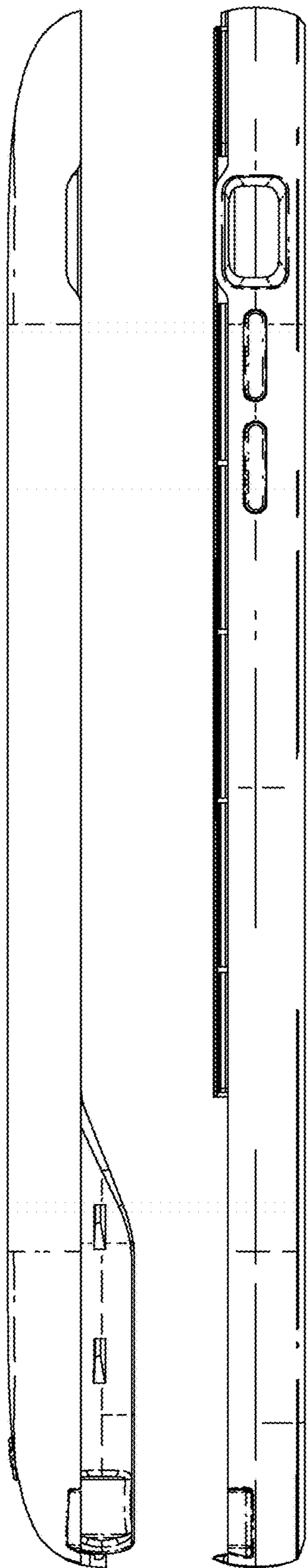

FIG. 13

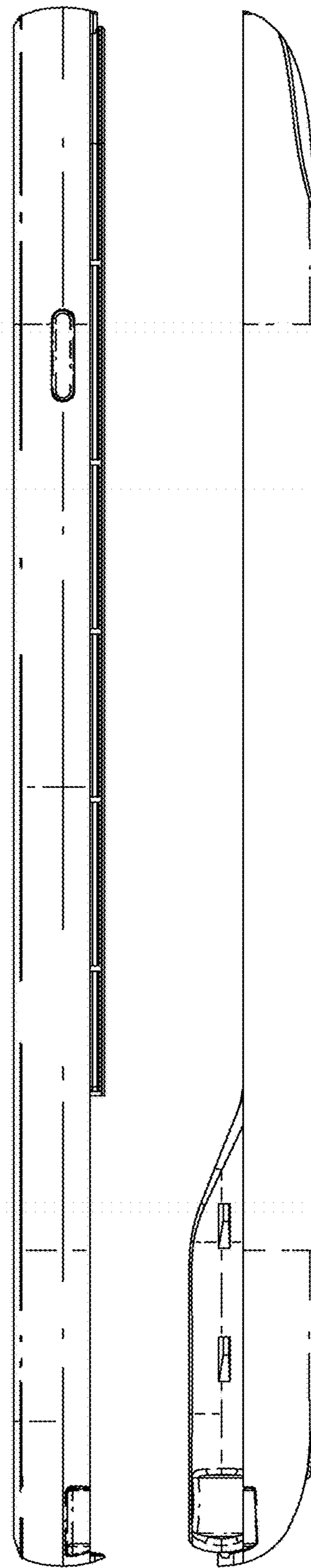

FIG. 14

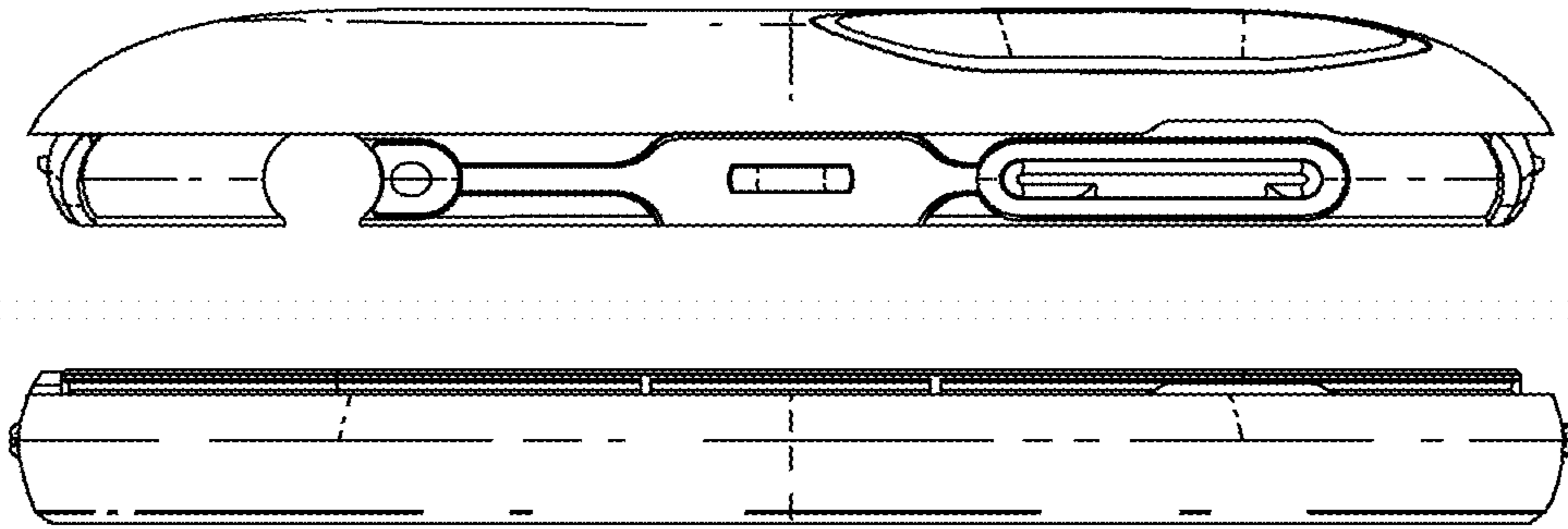

FIG. 15

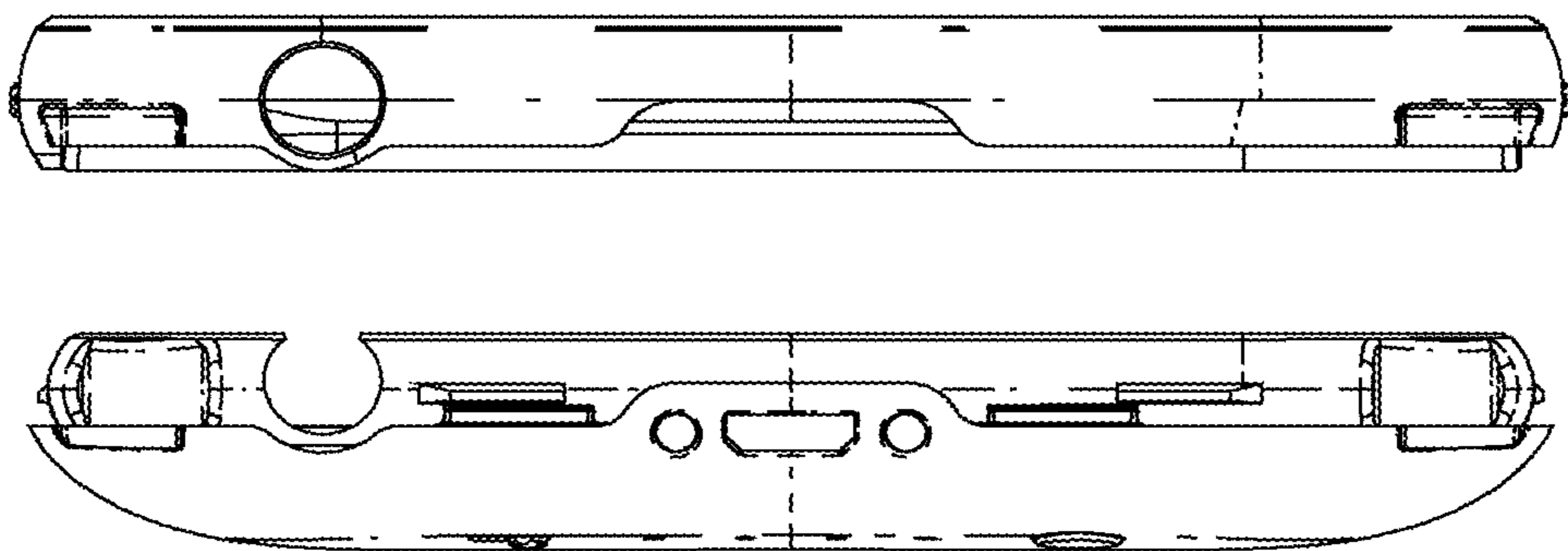

FIG. 16

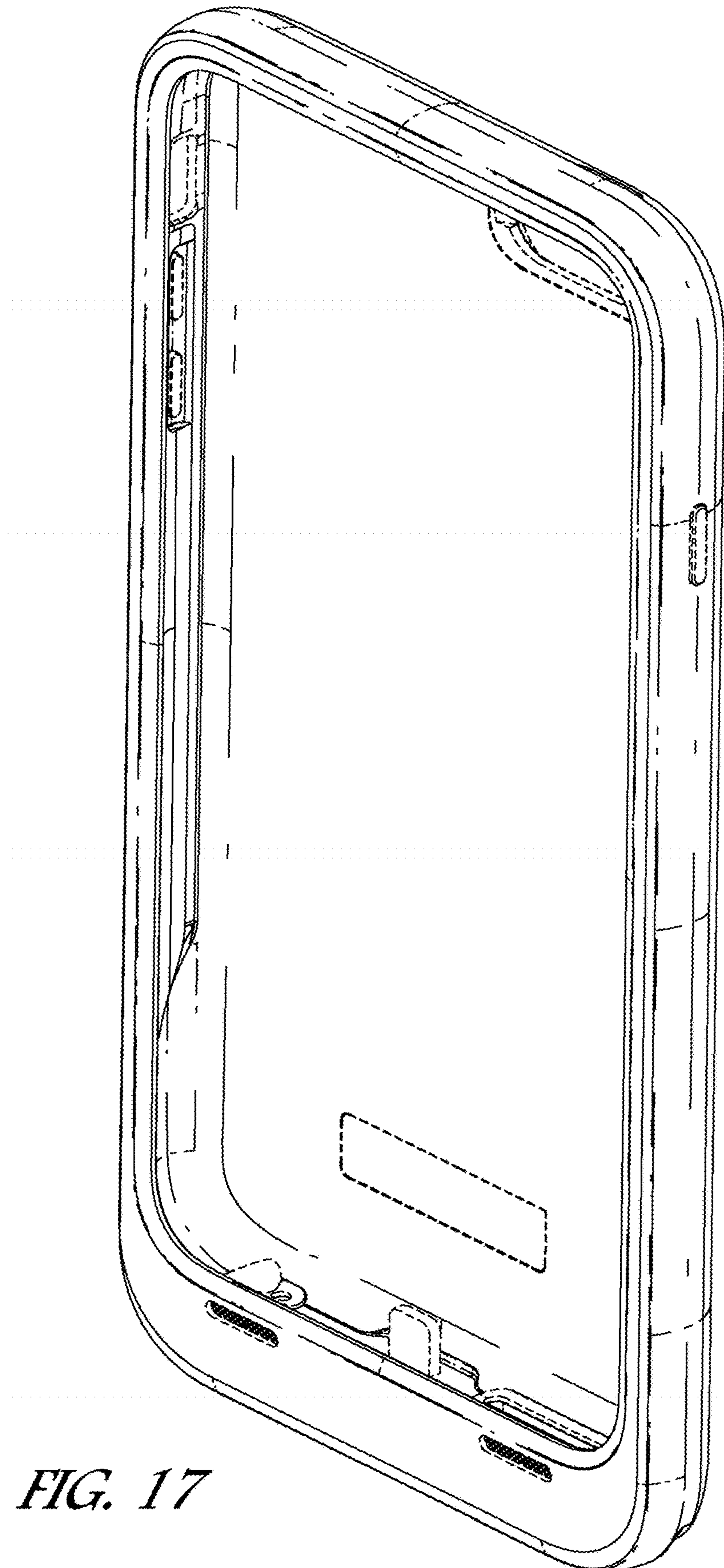

FIG. 17

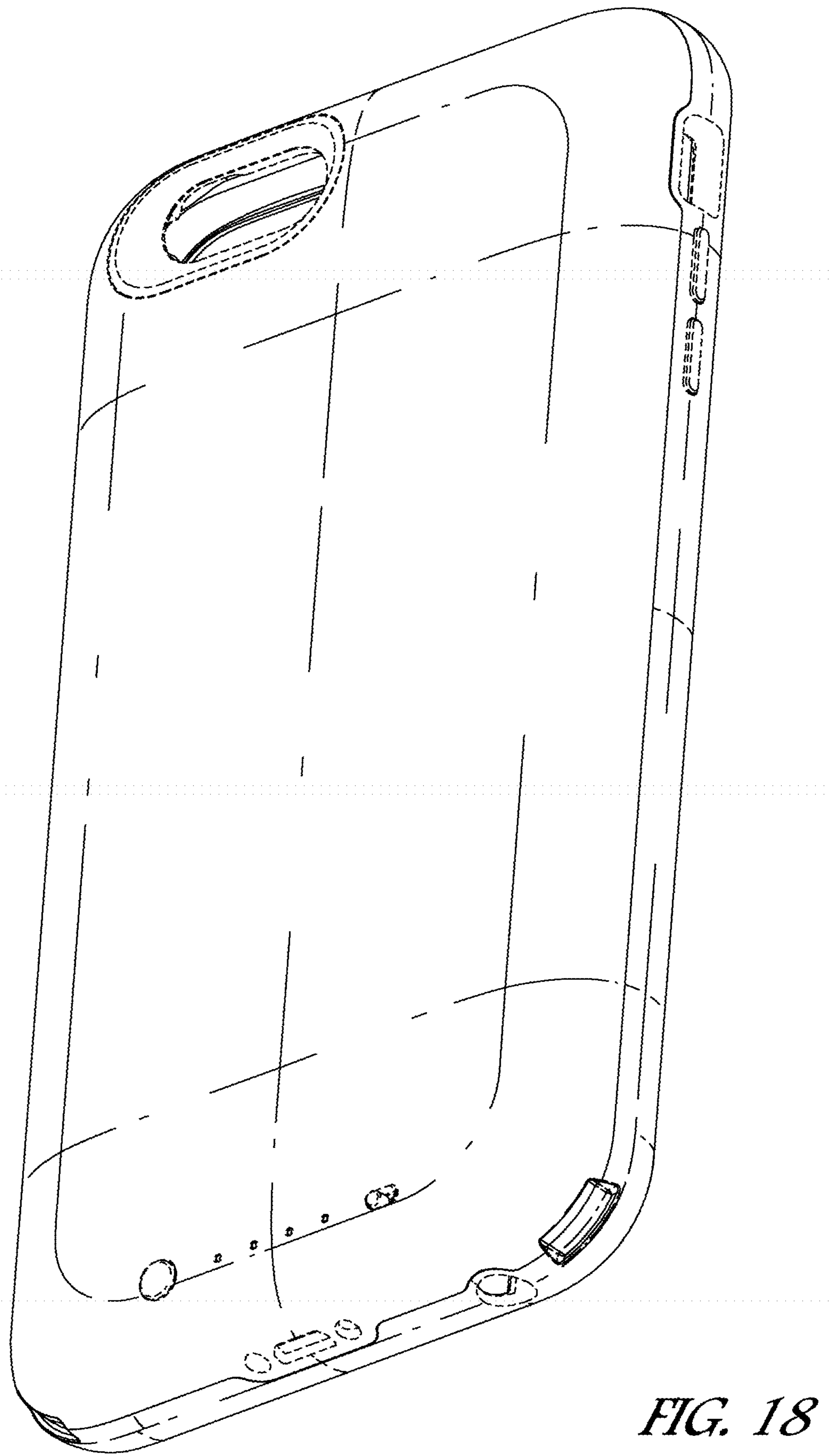

FIG. 18

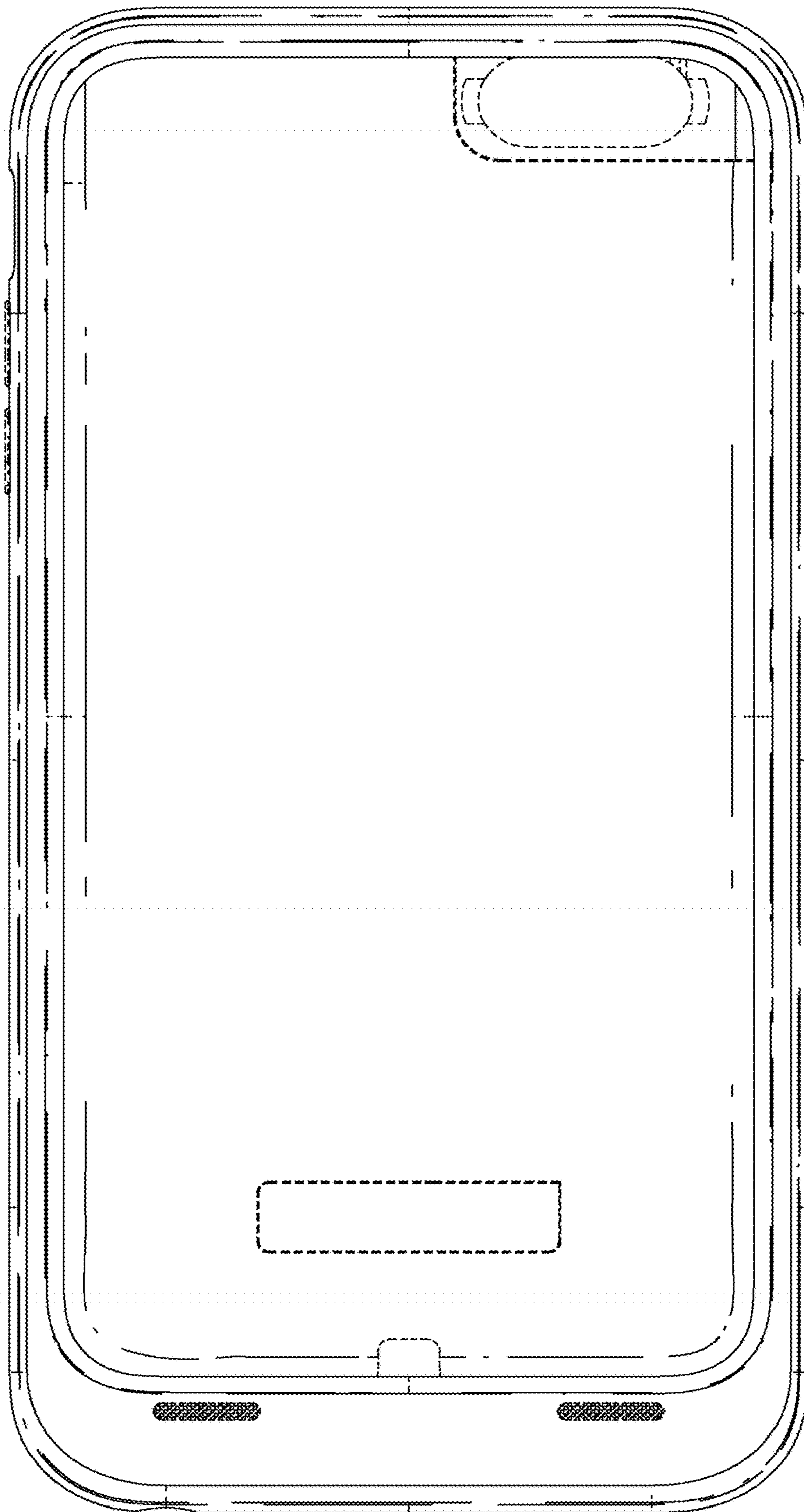

FIG. 19

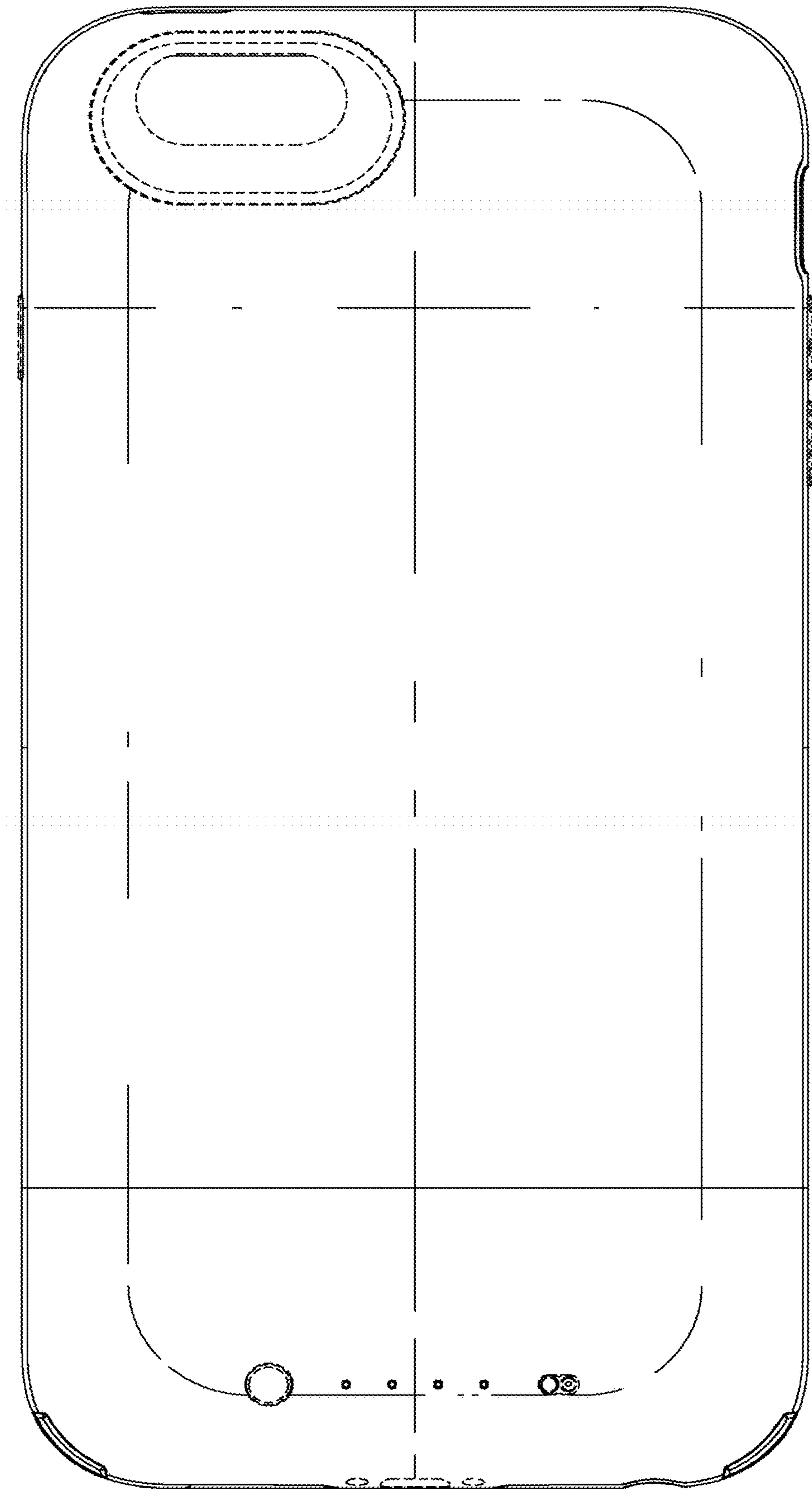

FIG. 20

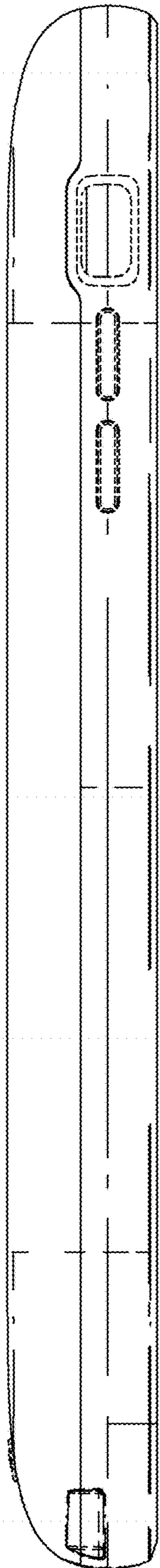

FIG. 21

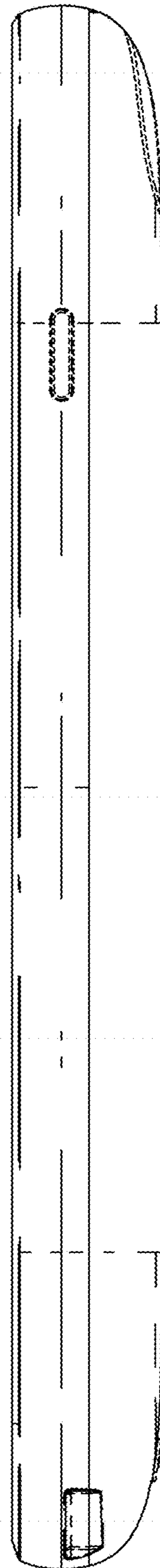

FIG. 22

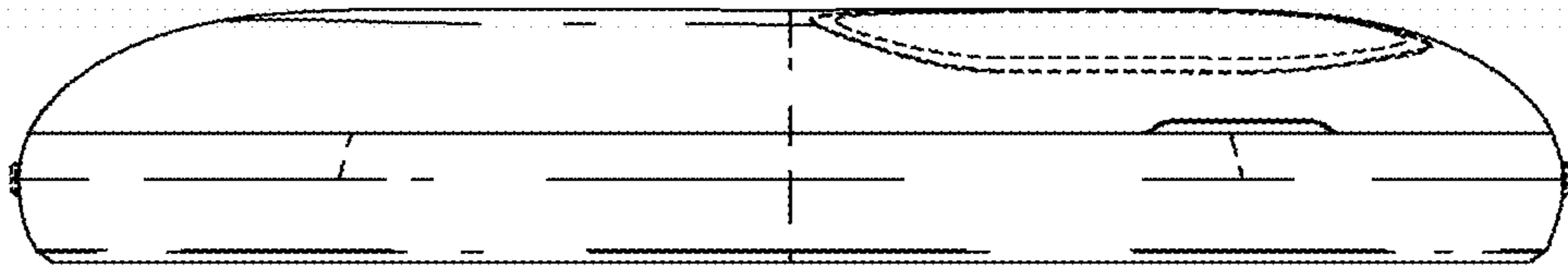

FIG. 23

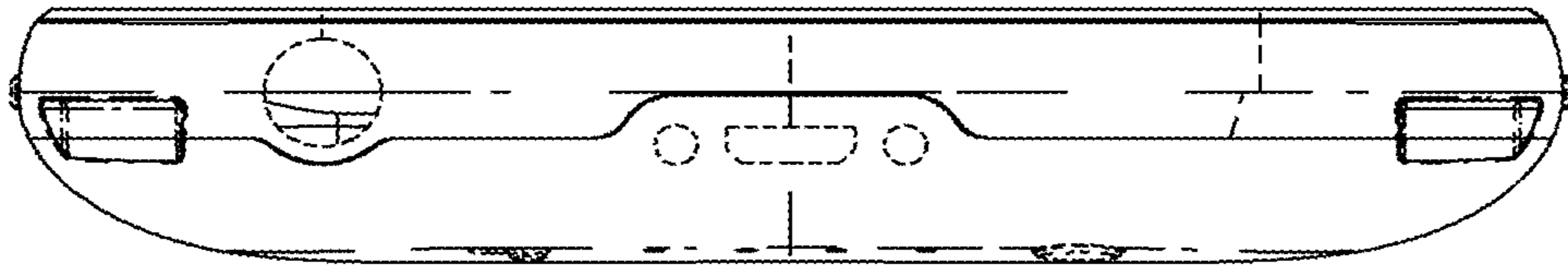

FIG. 24

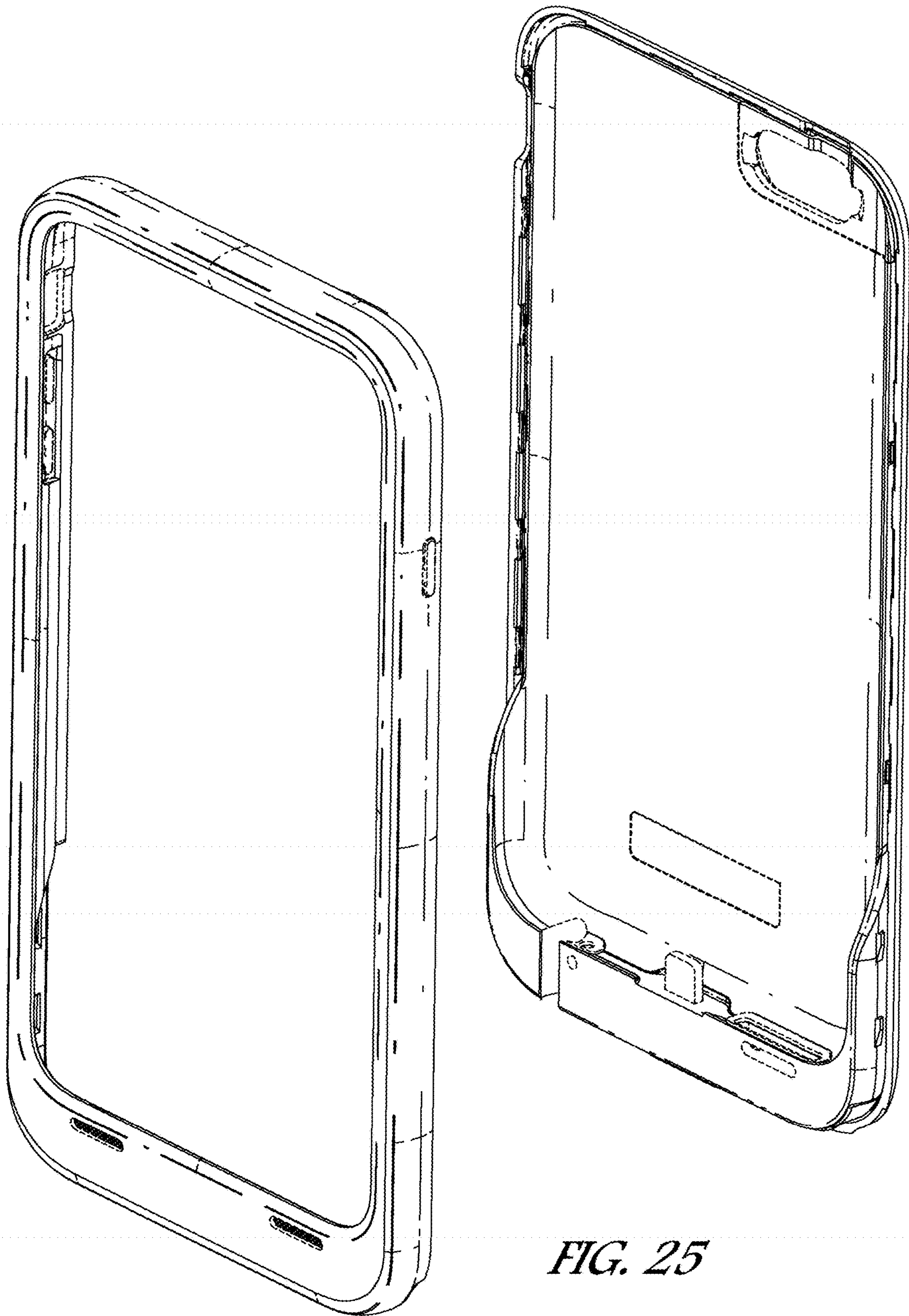

FIG. 25

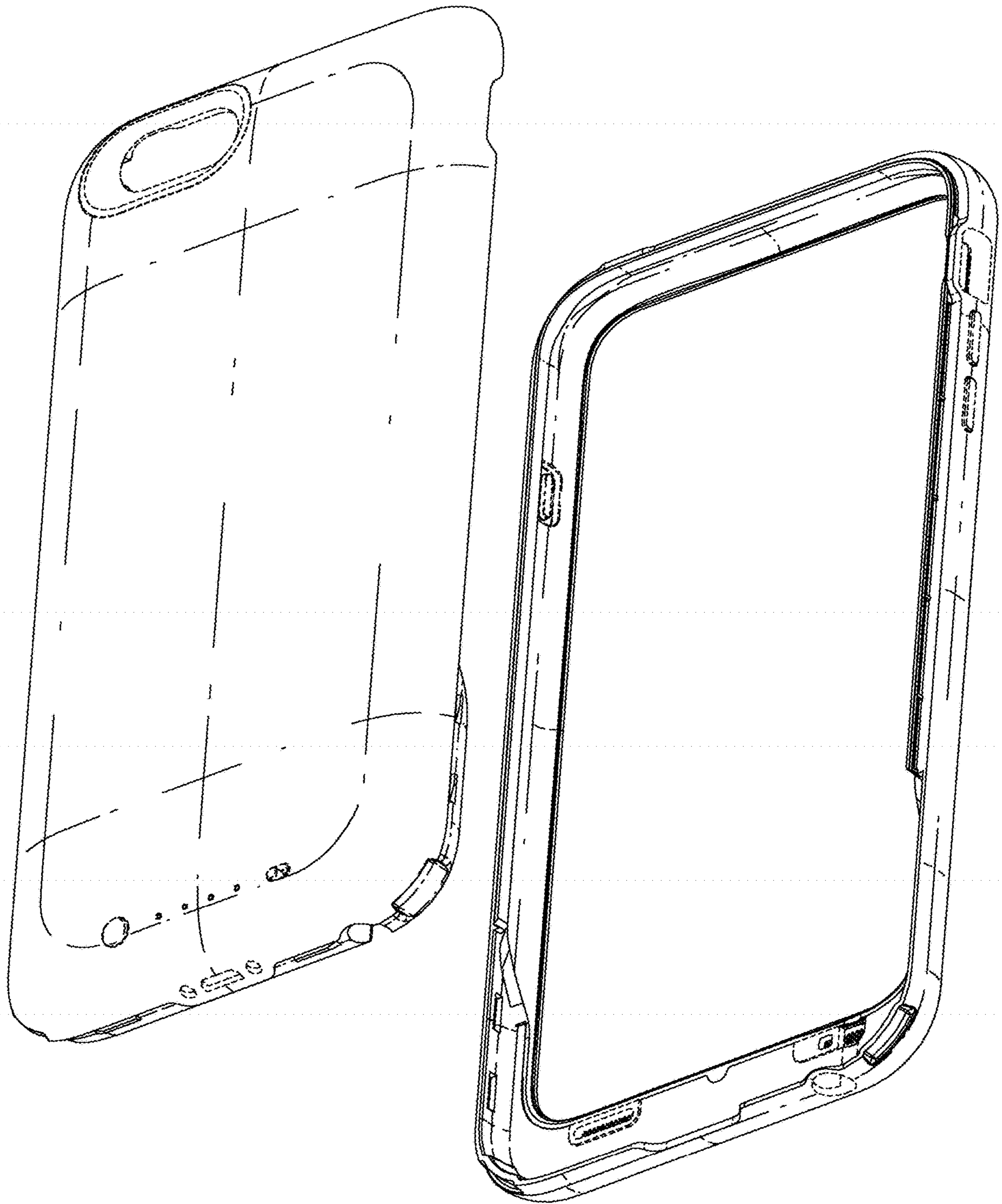

FIG. 26

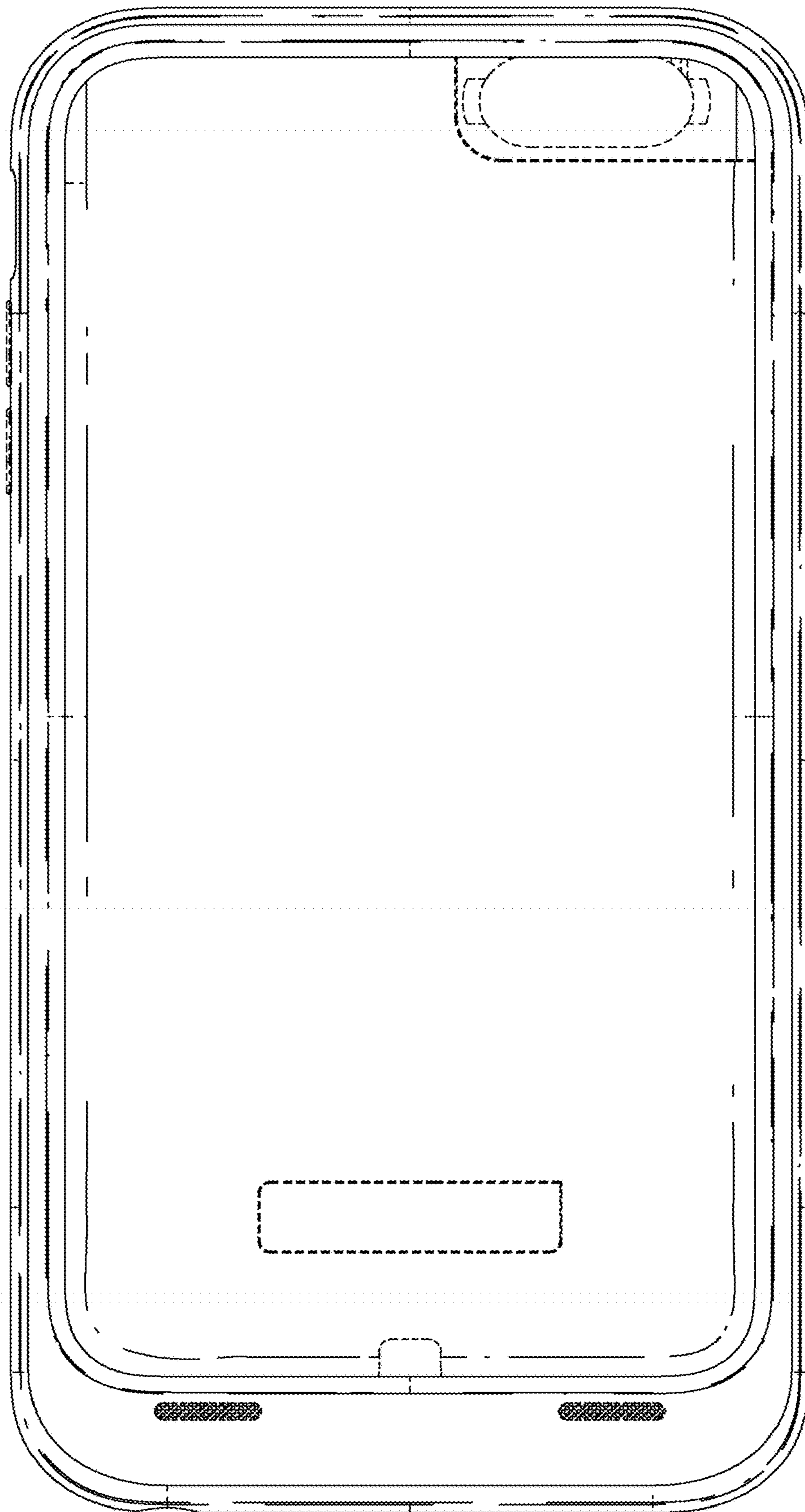

FIG. 27

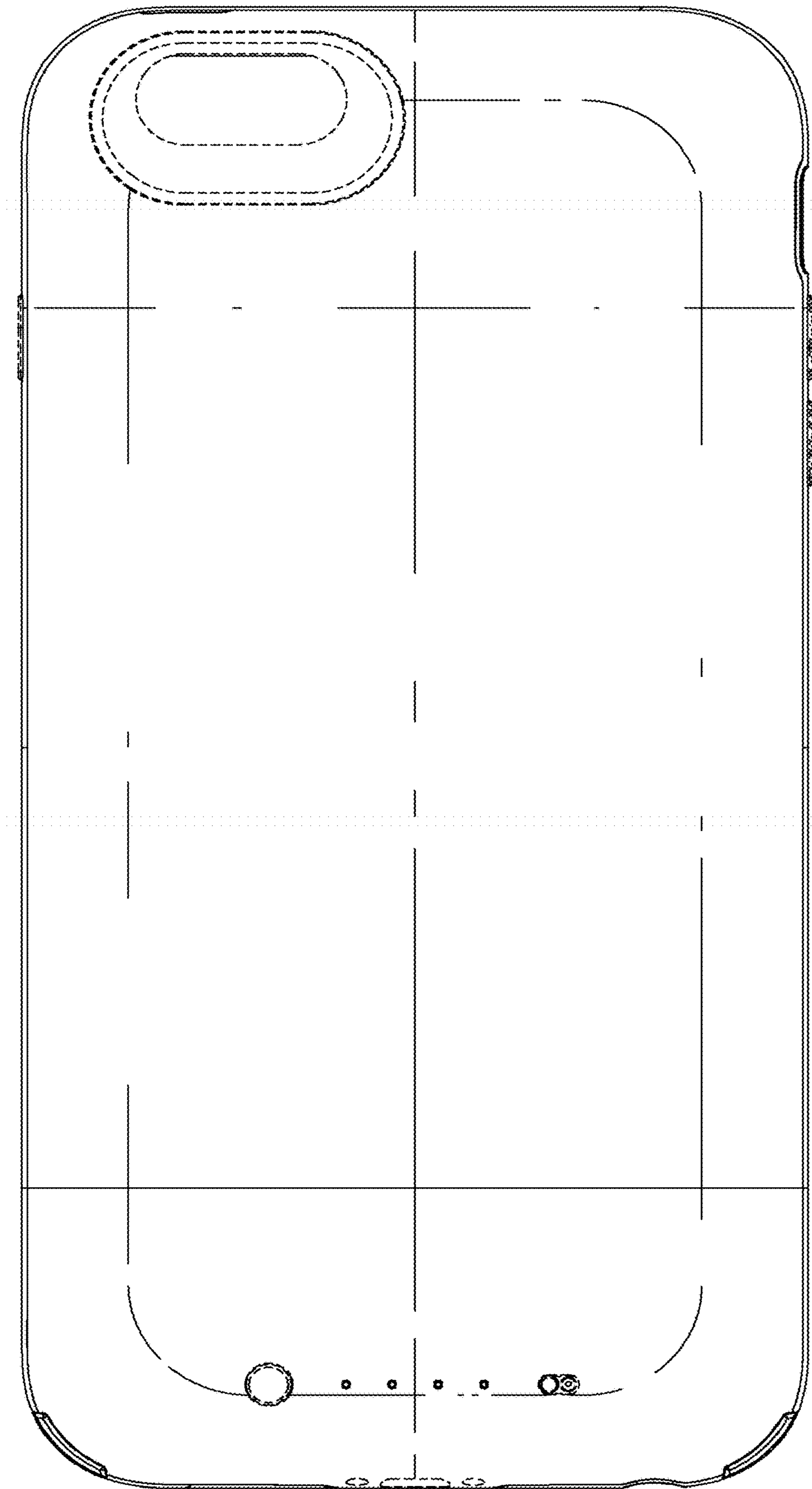

FIG. 28

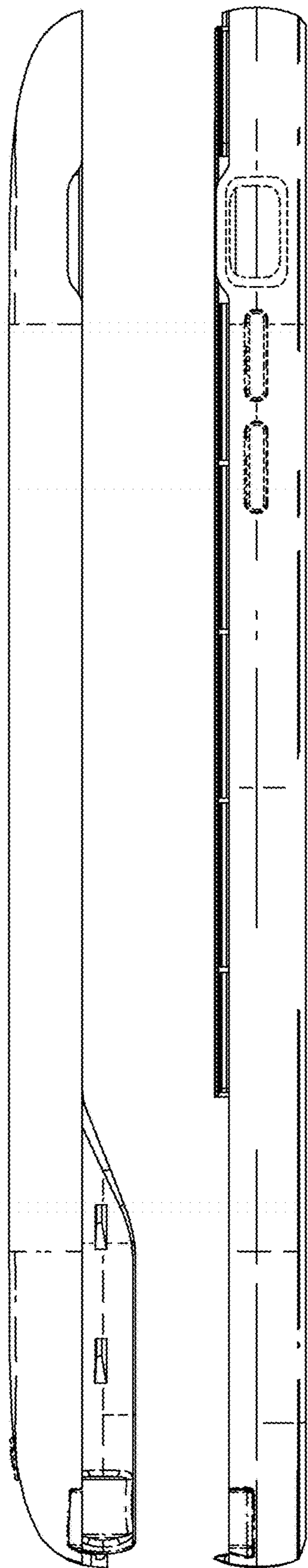

FIG. 29

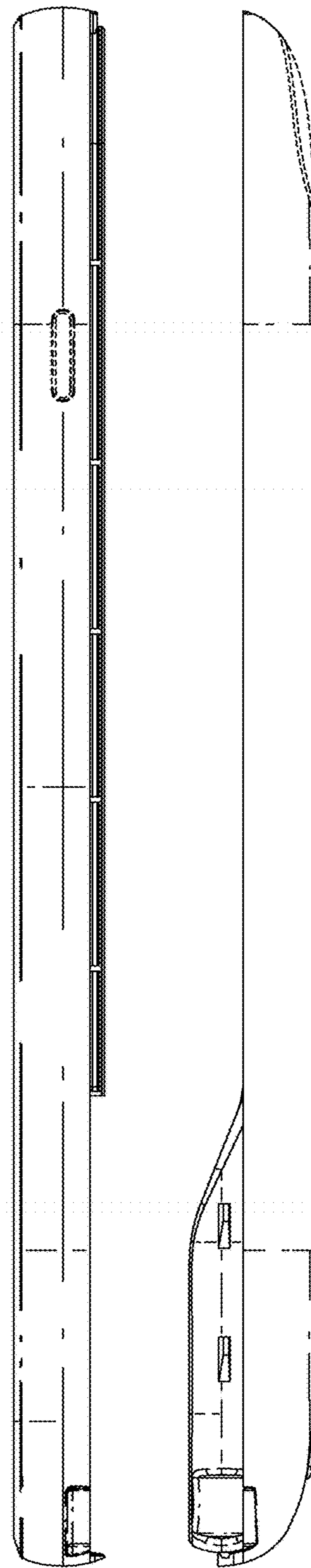

FIG. 30

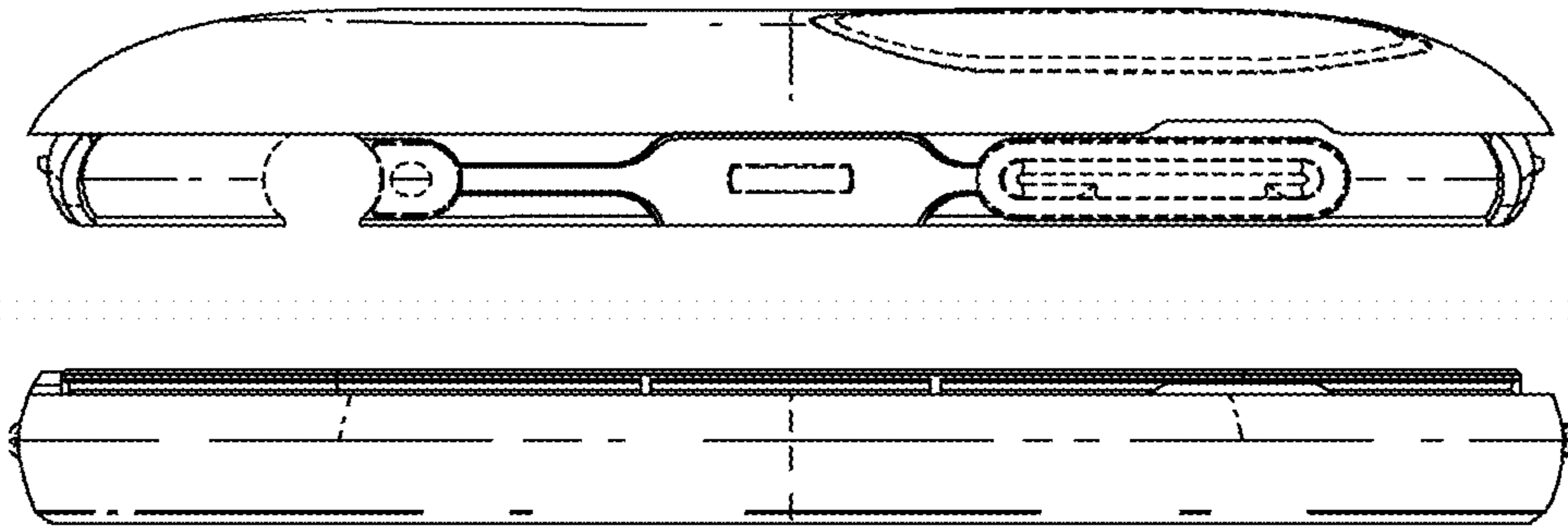

FIG. 31

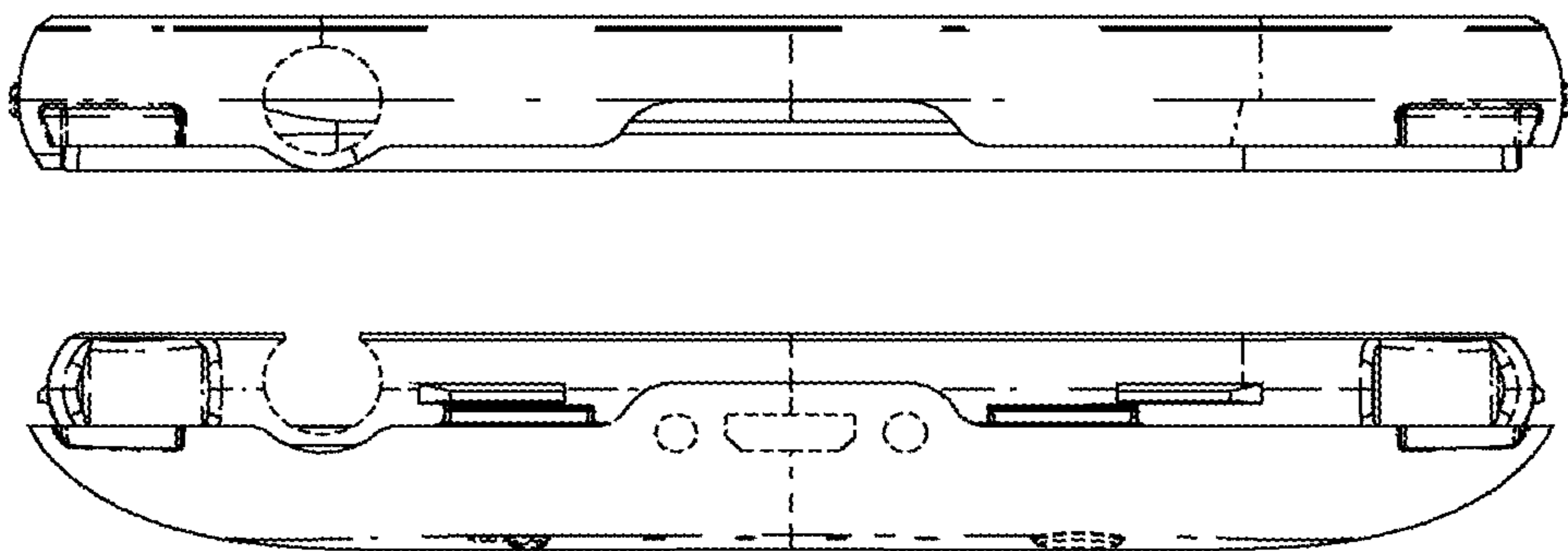

FIG. 32