



US00D950491S

(12) **United States Design Patent** (10) **Patent No.:** **US D950,491 S**
Bryan (45) **Date of Patent:** **** May 3, 2022**

(54) **TOWER WITH WIND OR WATER ROTOR GENERATORS**

(71) Applicant: **Charles Bryan**, Mojave, CA (US)

(72) Inventor: **Charles Bryan**, Mojave, CA (US)

(**) Term: **15 Years**

(21) Appl. No.: **29/788,002**

(22) Filed: **Feb. 5, 2021**

(51) **LOC (13) Cl.** **13-01**

(52) **U.S. Cl.**
USPC **D13/115**

(58) **Field of Classification Search**
USPC D13/112, 101, 113, 114, 115, 122, 184,
D13/199; D12/344, 345
CPC .. H02K 3/24; H02K 3/47; Y02E 10/30; Y02E
10/38; Y02E 10/72; Y02E 10/728; F02B
63/04; F03B 13/183; F03B 13/184; F03D
1/0633; F03D 1/04; F03D 1/06; F03D
7/048; F03D 9/00; E04C 5/08; E04H
12/00

See application file for complete search history.

(56) **References Cited**

U.S. PATENT DOCUMENTS

4,079,264 A * 3/1978 Cohen F03D 1/04
415/4.4
4,321,005 A * 3/1982 Black F03D 80/70
415/61
6,478,077 B1 * 11/2002 Story C01B 3/0005
62/480
D587,196 S * 2/2009 Chong D13/115
D598,376 S * 8/2009 Cheung D13/115
7,802,412 B2 * 9/2010 Jensen F03D 13/10
52/651.07

8,567,131 B2 * 10/2013 Ollgaard E04H 12/342
52/40
8,636,836 B2 * 1/2014 Mudawar F28F 1/12
165/104.19
8,998,562 B2 * 4/2015 Nica F03D 15/10
415/4.4
D737,767 S * 9/2015 Schwaiger D13/115

* cited by examiner

Primary Examiner — Derrick E Holland
(74) *Attorney, Agent, or Firm* — Dunlap Bennett & Ludwig, PLLC

(57) **CLAIM**

The ornamental design for a tower with wind or water rotor generators, as shown and described.

DESCRIPTION

FIG. 1 is a top front right perspective view of the tower with wind or water rotor generators, showing my new design, the top rear left perspective view being an identical image thereof;

FIG. 2 is a bottom front right perspective view thereof, the bottom rear left perspective view being an identical image thereof;

FIG. 3 is a front elevation view thereof;

FIG. 4 is a rear elevation view thereof;

FIG. 5 is a left side elevation view thereof;

FIG. 6 is a right side elevation view thereof;

FIG. 7 is a top plan view thereof; and,

FIG. 8 is a bottom plan view thereof.

The evenly-sized broken lines shown in the drawings depict portions of the tower with wind or water rotor generators that form no part of the claimed design.

The unevenly-sized broken lines define the bounds of the claimed design and form no part of the claimed design.

1 Claim, 4 Drawing Sheets

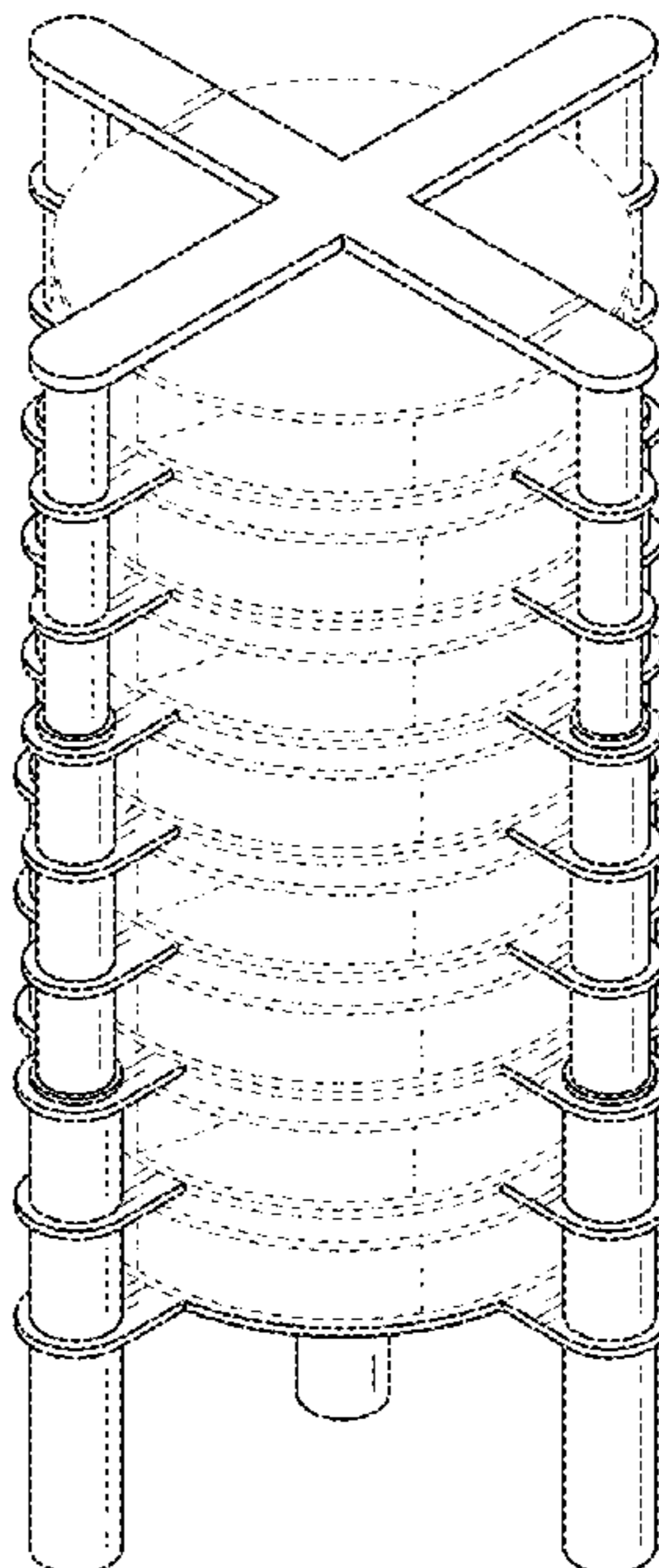

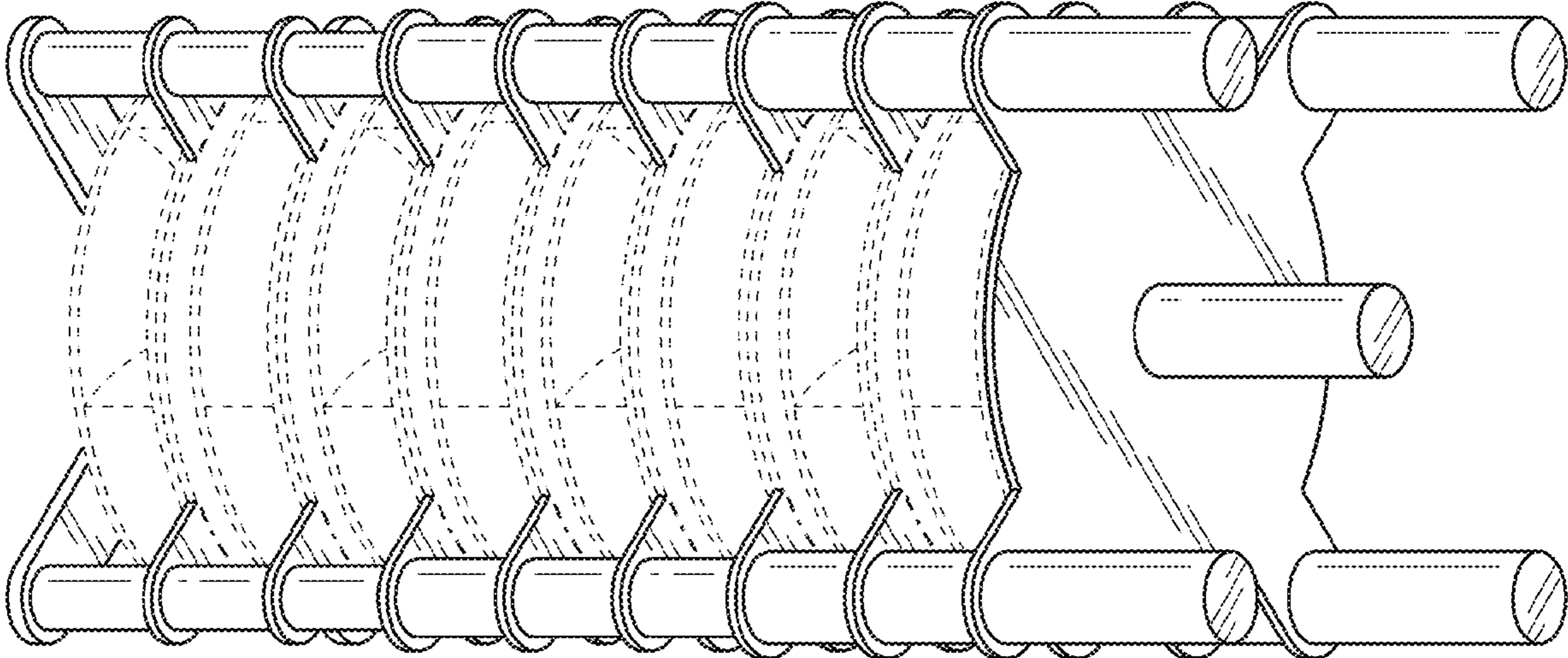

FIG. 1

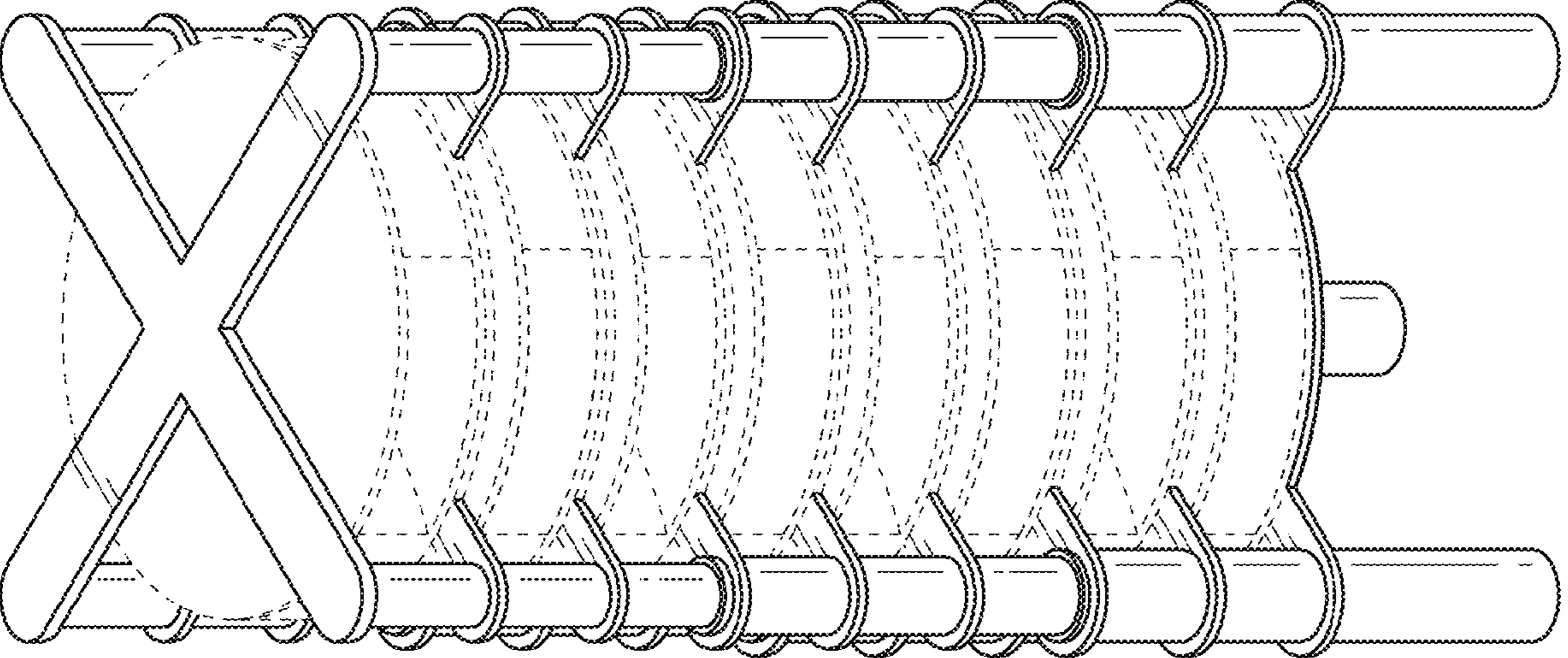

FIG. 2

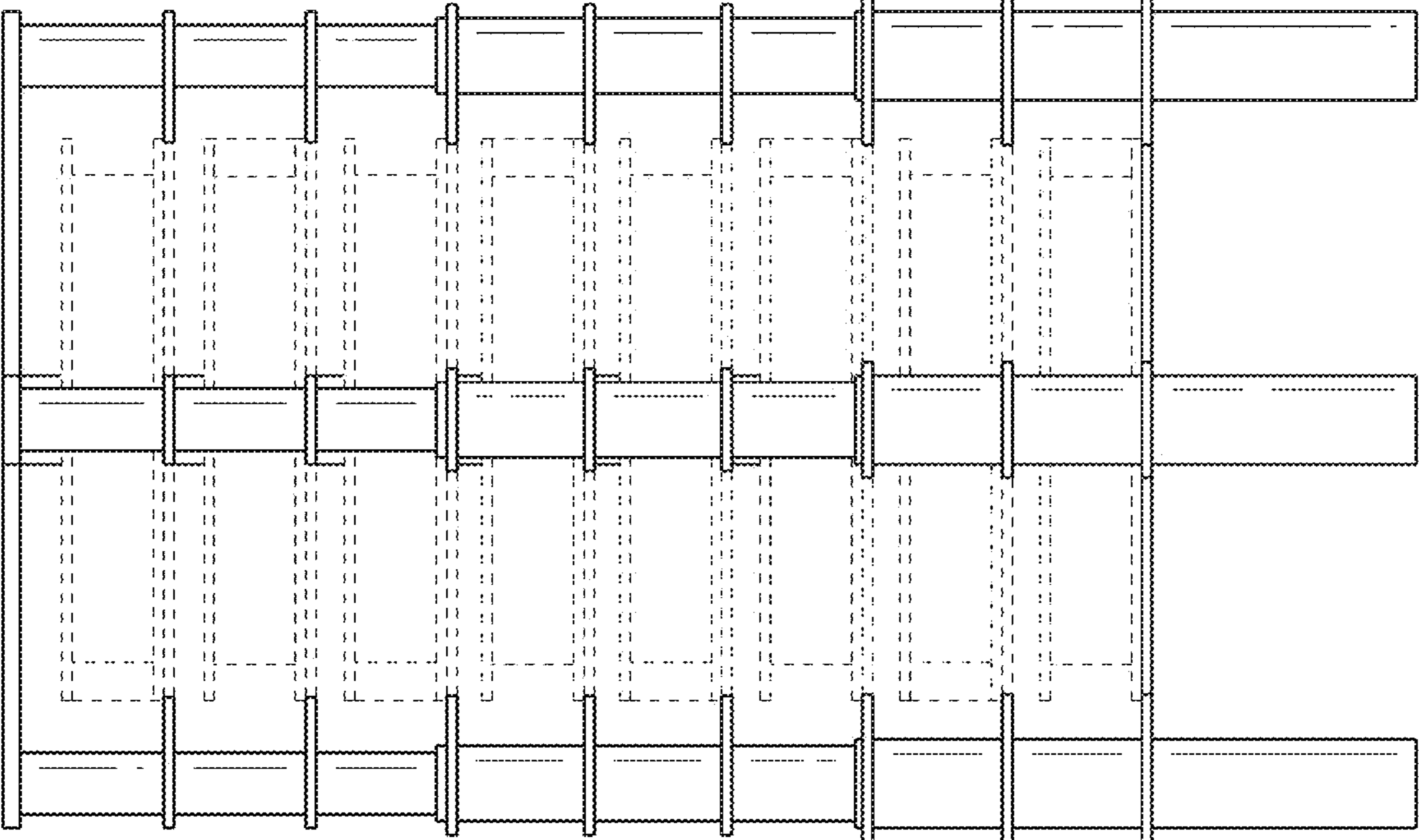

FIG. 4

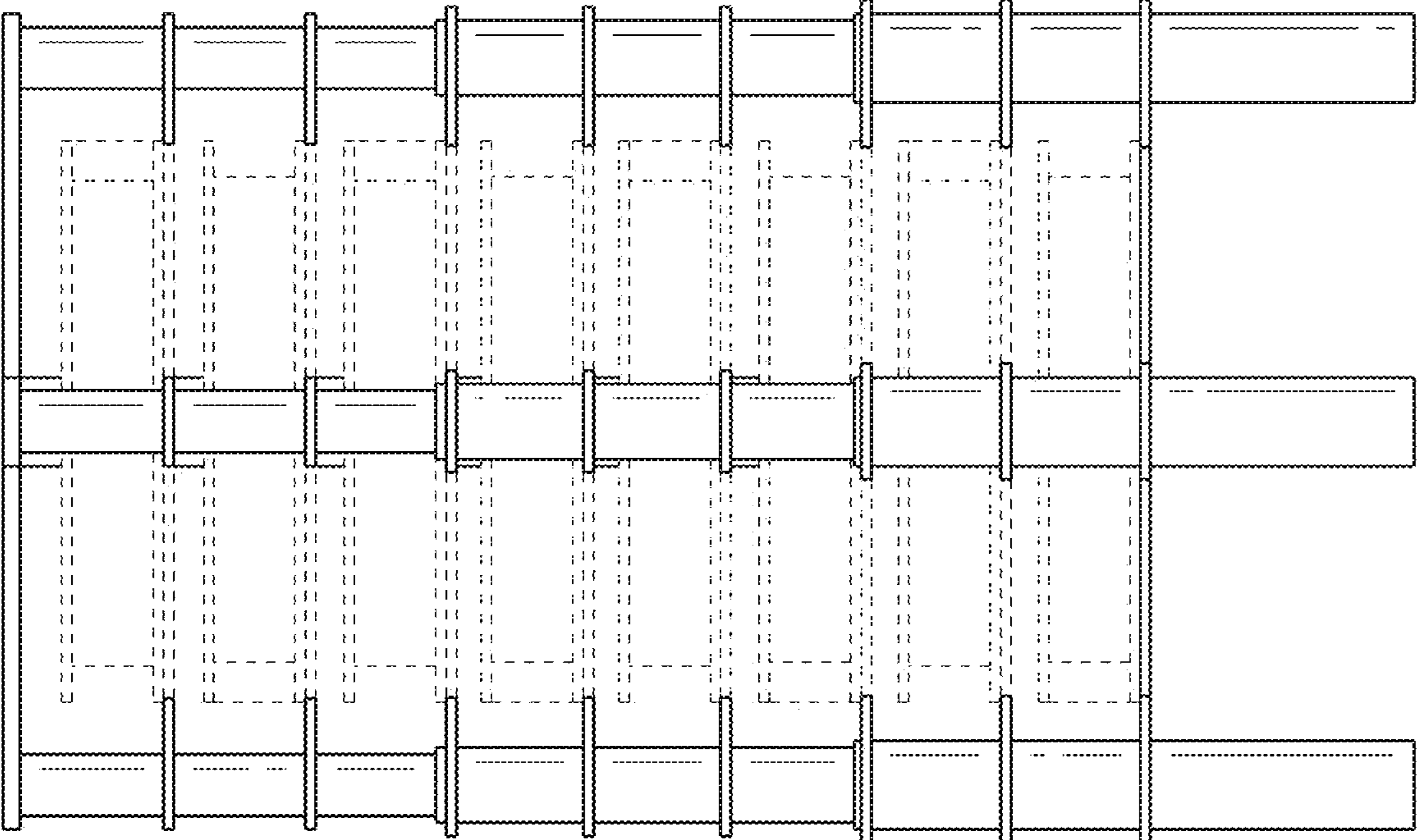

FIG. 3

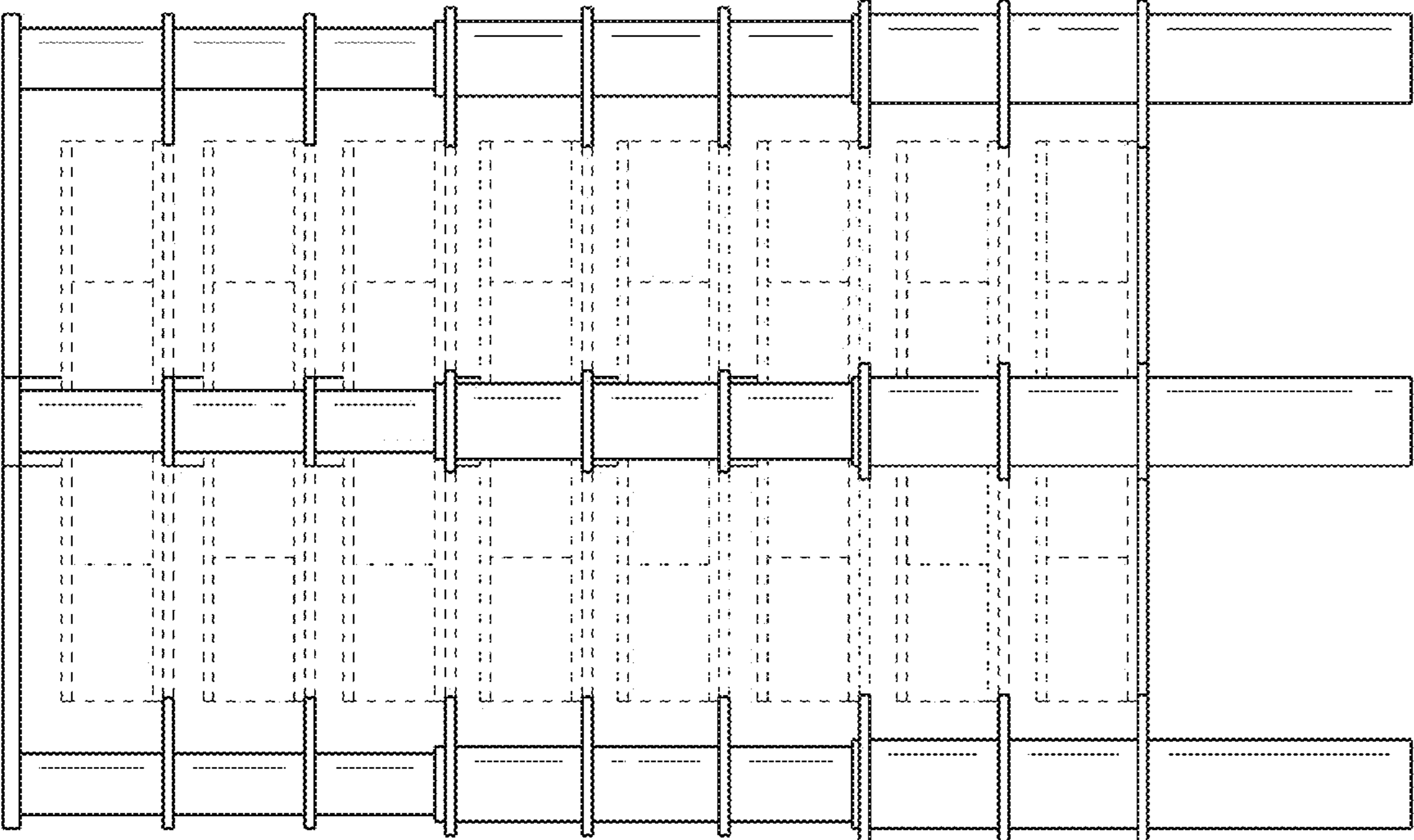

FIG. 6

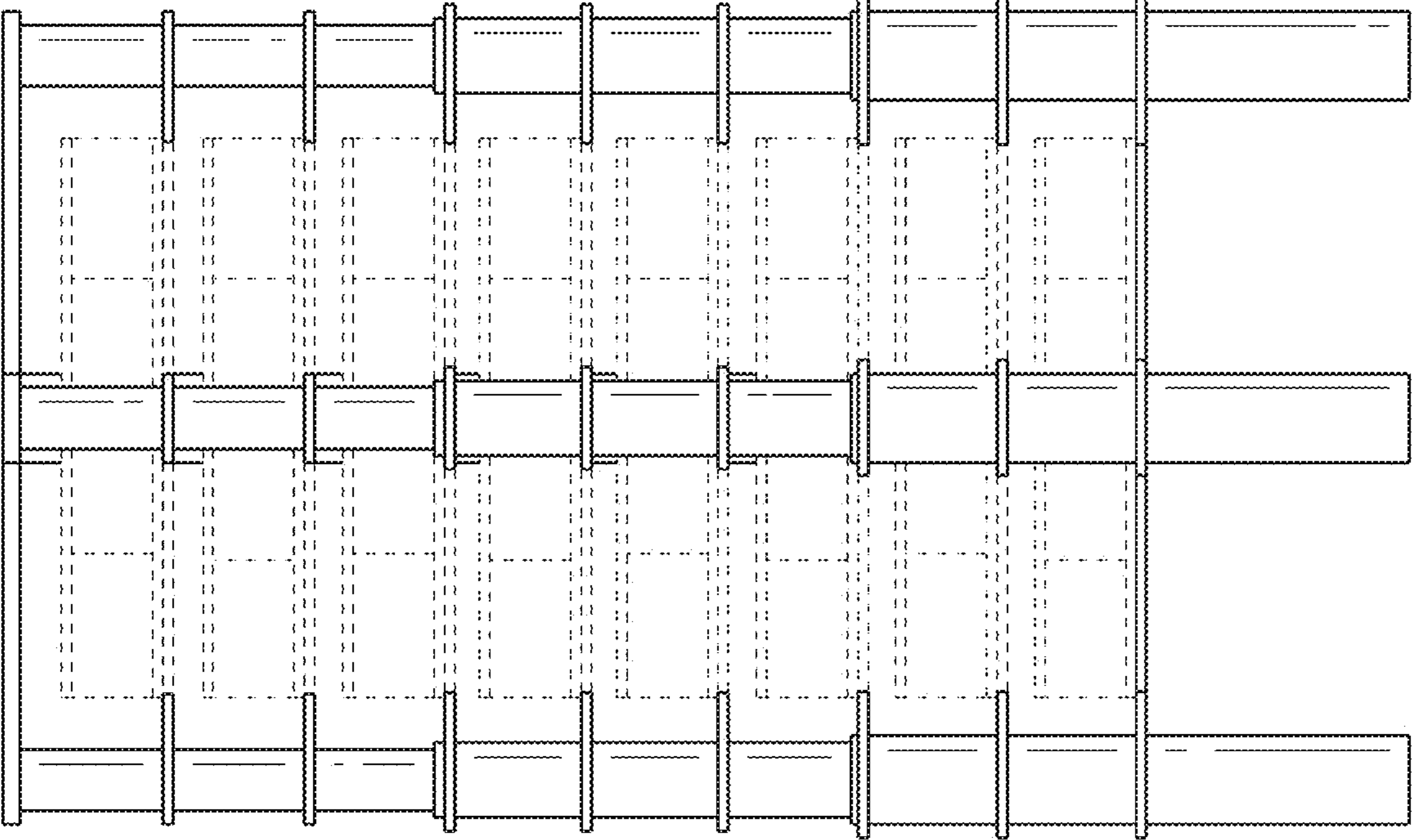

FIG. 5

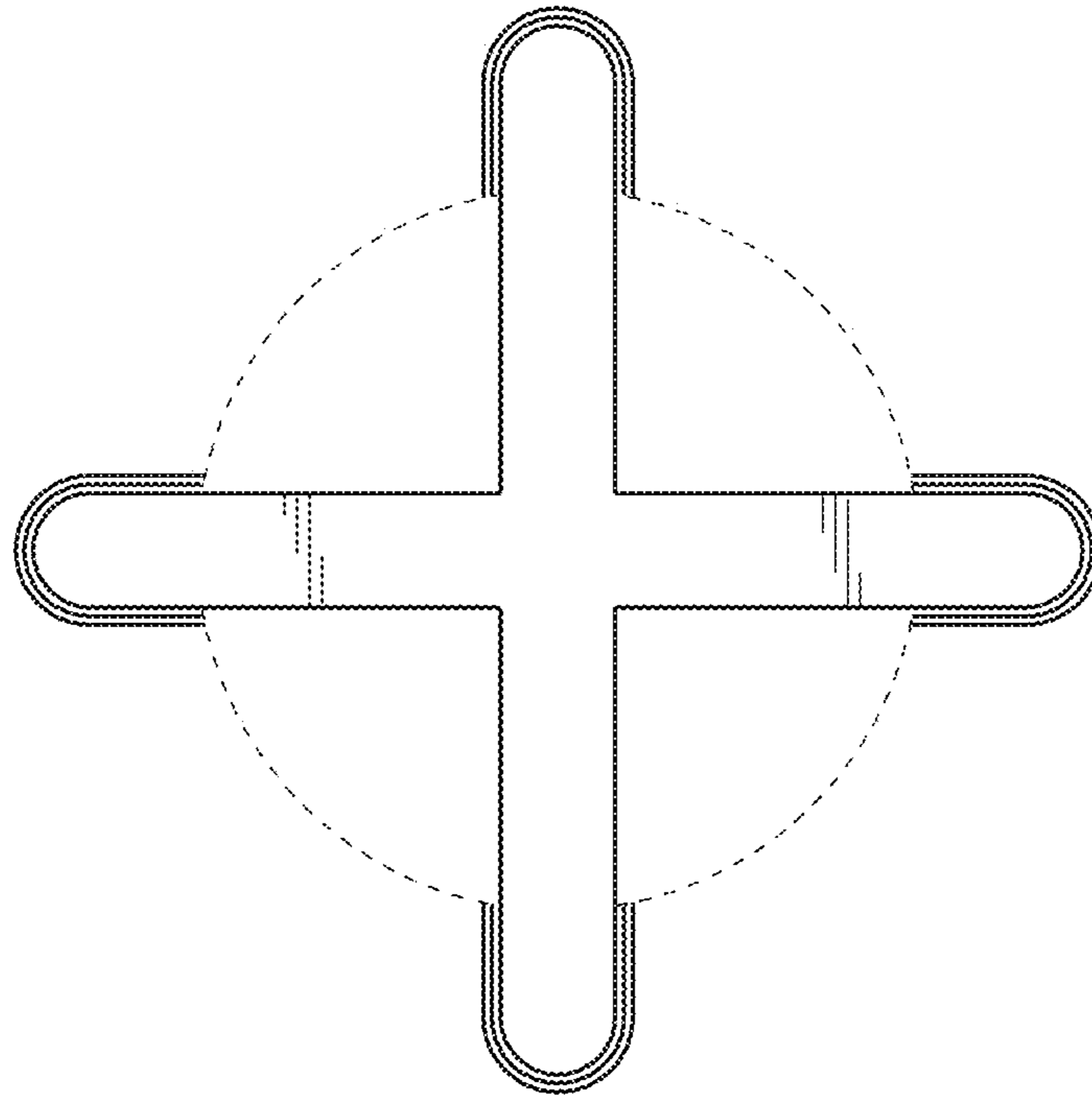

FIG. 7

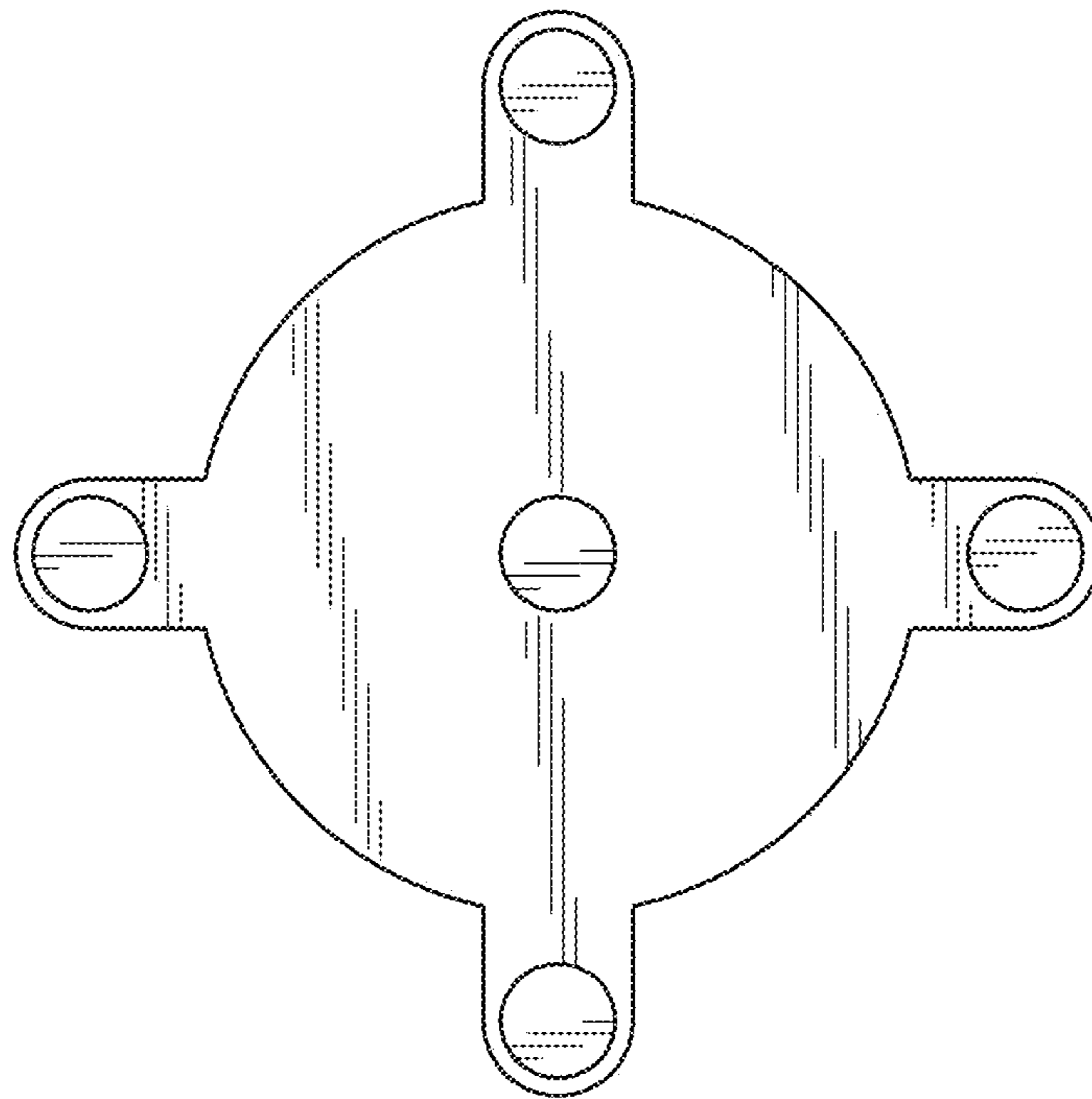

FIG. 8