



US00D950438S

(12) **United States Design Patent** (10) **Patent No.:** **US D950,438 S**
Ruiz (45) **Date of Patent:** **** May 3, 2022**

(54) **VEHICLE FRONT FENDER SEGMENT**
(71) Applicant: **GM GLOBAL TECHNOLOGY OPERATIONS LLC**, Detroit, MI (US)
(72) Inventor: **Gary W. Ruiz**, Royal Oak, MI (US)
(73) Assignee: **GM Global Technology Operations LLC**, Detroit, MI (US)

D775,010 S 12/2016 Kim et al.
D776,583 S 1/2017 Scheer et al.
D786,149 S 5/2017 Pevovar et al.
D787,990 S 5/2017 Kozub et al.
D792,293 S 7/2017 McCabe et al.
D792,295 S 7/2017 McCabe et al.
D792,815 S 7/2017 Kozub
D792,816 S 7/2017 Kozub
D793,292 S 8/2017 Lee

(Continued)

(**) Term: **15 Years**

(21) Appl. No.: **29/771,476**

(22) Filed: **Feb. 23, 2021**

(51) **LOC (13) Cl.** **12-16**

(52) **U.S. Cl.**
USPC **D12/169**

(58) **Field of Classification Search**
USPC D12/86, 91, 93, 163, 164, 165, 166, 167,
D12/169, 171, 172, 173, 190, 216
CPC B60R 19/00; B60R 19/02; B60R 19/18;
B60R 19/24; B60R 19/52; B60R 19/56;
B60R 2019/007; B60R 2019/525; B60R
2019/527; B60R 13/04; B60K 11/08;
B62D 25/08

See application file for complete search history.

(56) **References Cited**

U.S. PATENT DOCUMENTS

D717,703 S 11/2014 Munson et al.
D720,668 S 1/2015 Pevovar et al.
D745,837 S 12/2015 Smith et al.
D749,021 S 2/2016 Boniface et al.
D753,034 S 4/2016 Thole et al.
D753,559 S 4/2016 McMahan et al.
D753,560 S 4/2016 McMahan et al.
D771,532 S 11/2016 Kapitonov
D771,533 S 11/2016 Kapitonov
D772,766 S 11/2016 Kozub et al.
D772,767 S 11/2016 Kim
D775,007 S 12/2016 Thole et al.

OTHER PUBLICATIONS

Bumper Corners. (Design—© Questel) orbit.com. [Online PDF compilation of references] 64 pgs. Print Dates Range Dec. 3, 2020-May 25, 2021 [Retrieved Jan. 21, 2022].*

(Continued)

Primary Examiner — Manpreet S Matharu
Assistant Examiner — Suzanne E Tisdell

(57) **CLAIM**

The ornamental design for a vehicle front fender segment, as shown and described.

DESCRIPTION

FIG. 1 is a front and right perspective view of a vehicle front fender segment showing my new design; the mirror image of the vehicle front fender segment is claimed, but not shown; FIG. 2 is a front elevation view of the vehicle front fender segment of FIG. 1; FIG. 3 is a left elevation view thereof; FIG. 4 is a right elevation view thereof; FIG. 5 is a top view thereof; FIG. 6 is a back elevation view thereof; and, FIG. 7 is a bottom view thereof. The broken lines in the drawings depict portions of the vehicle front fender segment that form no part of the claimed design.

1 Claim, 7 Drawing Sheets

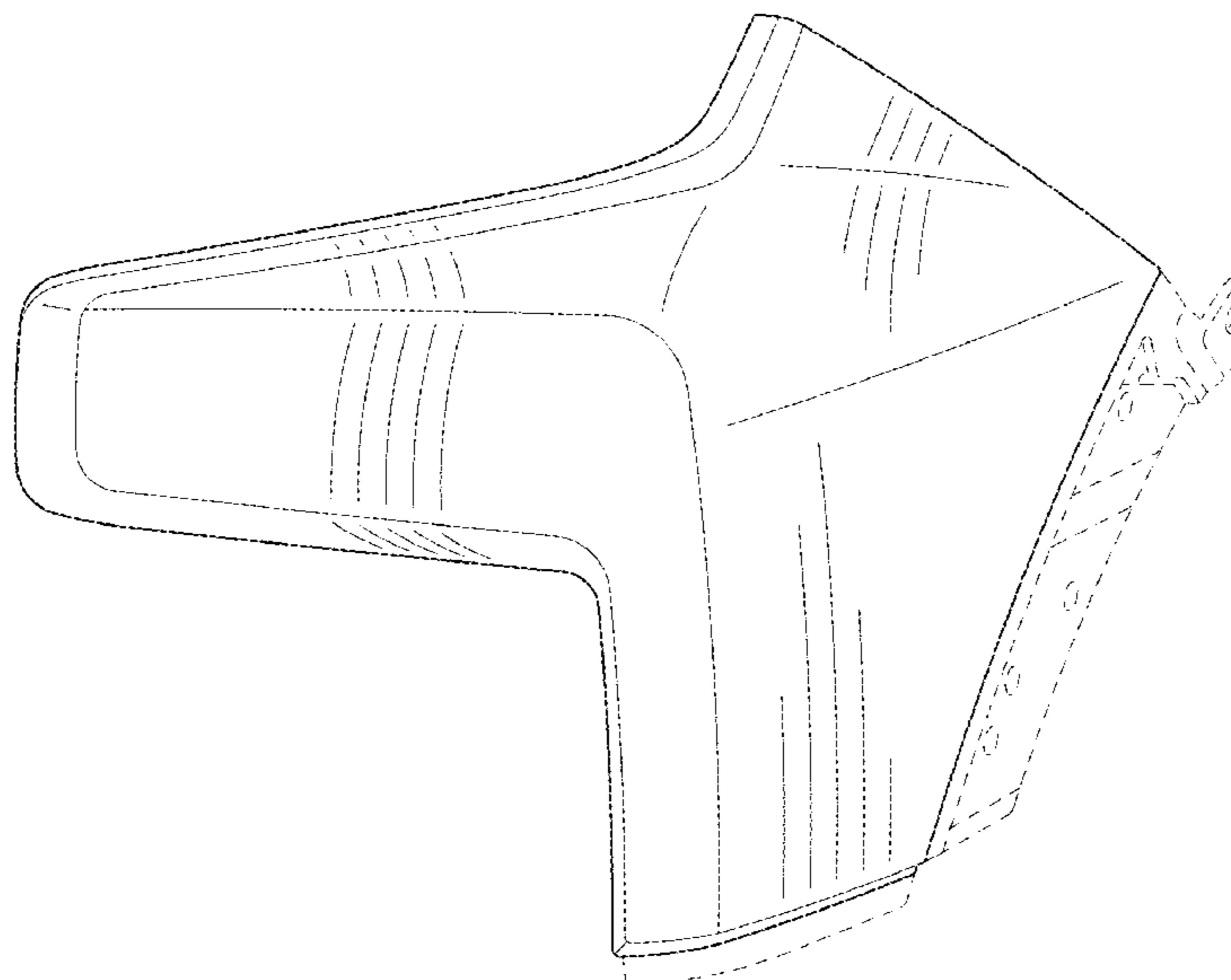

(56)

References Cited

U.S. PATENT DOCUMENTS

D793,293 S 8/2017 Lee et al.
 D793,296 S 8/2017 Smith et al.
 D793,297 S 8/2017 Smith et al.
 D793,301 S 8/2017 Kozub
 D793,302 S 8/2017 Kozub
 D798,204 S 9/2017 Mainville
 D802,496 S 11/2017 Mainville
 D811,957 S 3/2018 Whitla et al.
 D811,960 S 3/2018 Nakamura
 D811,964 S 3/2018 Perkins
 D812,526 S 3/2018 Zipfel et al.
 D812,527 S 3/2018 Perkins
 D812,528 S 3/2018 Nakamura
 D813,109 S 3/2018 Zipfel et al.
 D813,734 S 3/2018 Nakamura
 D814,369 S 4/2018 Loeb
 D816,558 S 5/2018 McMahan et al.
 D816,559 S 5/2018 McMahan et al.
 D816,561 S 5/2018 McMahan
 D816,562 S 5/2018 Whitla et al.
 D816,564 S 5/2018 Kim
 D816,566 S 5/2018 Loeb
 D818,406 S 5/2018 McMahan et al.
 D820,173 S 6/2018 McMahan
 D820,174 S 6/2018 Whitla et al.
 D821,941 S 7/2018 Mack et al.
 D821,950 S 7/2018 Kozub
 D822,550 S 7/2018 Wassell et al.
 D826,114 S 8/2018 Smith et al.
 D826,803 S 8/2018 Smith et al.
 D837,109 S 1/2019 Kozub et al.
 D840,293 S 2/2019 Koo et al.
 D841,532 S 2/2019 Koo et al.
 D843,275 S 3/2019 Koo et al.
 D845,187 S 4/2019 Pinazzo et al.
 D845,190 S 4/2019 Zipfel
 D845,196 S 4/2019 Kozub
 D847,042 S 4/2019 Pinazzo et al.
 D847,044 S 4/2019 Zipfel
 D847,704 S 5/2019 Zipfel
 D847,705 S 5/2019 Zipfel
 D847,707 S 5/2019 Park Cheng et al.
 D847,714 S 5/2019 Mack et al.
 D848,318 S 5/2019 McMahan et al.
 D848,322 S 5/2019 Mack et al.
 D848,323 S 5/2019 Mack et al.
 D848,324 S 5/2019 Thurber et al.
 D848,325 S 5/2019 Thurber et al.
 D850,989 S 6/2019 Kozub
 D851,555 S 6/2019 Whitla et al.
 D851,556 S 6/2019 Thurber et al.
 D851,557 S 6/2019 Thurber et al.
 D851,560 S 6/2019 Yong et al.
 D851,561 S 6/2019 Yong et al.
 D853,904 S 7/2019 Koo et al.
 D854,979 S 7/2019 Krieg et al.
 D855,508 S 8/2019 Wilkins et al.
 D855,509 S 8/2019 Wilkins
 D856,204 S 8/2019 Kapitonov
 D856,206 S 8/2019 De Leon
 D856,864 S 8/2019 Kapitonov
 D856,874 S 8/2019 Kozub
 D856,875 S 8/2019 Kozub
 D860,075 S 9/2019 Riggs et al.
 D860,076 S 9/2019 Bartels et al.
 D860,078 S 9/2019 O'Donnell et al.
 D862,337 S 10/2019 Pinazzo et al.

D863,140 S 10/2019 Wilkins et al.
 D863,147 S 10/2019 Zipfel
 D863,149 S 10/2019 Luke et al.
 D863,150 S 10/2019 Krieg et al.
 D863,152 S 10/2019 Kozub
 D864,057 S 10/2019 Krieg et al.
 D867,232 S 11/2019 Izard
 D868,639 S 12/2019 Wilkins et al.
 D868,650 S 12/2019 Gifford
 D868,651 S 12/2019 Gifford
 D868,656 S 12/2019 De Leon
 D870,619 S 12/2019 Gifford
 D873,733 S 1/2020 Kozub
 D874,362 S 2/2020 Izard
 D877,001 S 3/2020 Izard
 D877,002 S 3/2020 Izard
 D877,003 S 3/2020 Izard
 D877,004 S 3/2020 Wilkins et al.
 D877,007 S 3/2020 Zipfel
 D877,009 S 3/2020 Luke et al.
 D881,083 S 4/2020 Blanski et al.
 D882,466 S 4/2020 Yong et al.
 D885,265 S 5/2020 Zipfel
 D887,323 S 6/2020 Zipfel
 D889,331 S 7/2020 O'Donnell et al.
 D892,003 S 8/2020 Zipfel
 D894,060 S 8/2020 Izard
 D894,061 S 8/2020 Zipfel
 D902,802 S 11/2020 Choi et al.
 D902,803 S 11/2020 Choi et al.
 D902,817 S 11/2020 Choi et al.
 D902,818 S 11/2020 Choi et al.
 D903,567 S 12/2020 Choi et al.
 D918,796 S * 5/2021 Ruiz D12/169
 D920,191 S * 5/2021 Lee D12/169
 D920,859 S * 6/2021 Buller D12/169
 D924,749 S * 7/2021 Lee D12/169
 D924,751 S * 7/2021 Kaoud D12/169
 D927,372 S * 8/2021 Phan D12/169
 D930,521 S * 9/2021 Choi D12/169
 D930,529 S * 9/2021 Park D12/169
 D933,551 S * 10/2021 Wraith D12/169
 D937,145 S * 11/2021 Kaoud D12/169
 D937,151 S * 11/2021 Wraith D12/169
 D937,152 S * 11/2021 Hamilton D12/169
 D937,155 S * 11/2021 Kaoud D12/169

OTHER PUBLICATIONS

Mercedes Sprinter Bumper Corner Back With Red Reflector Right Passenger Side. 2017. IMS Auto Parts. https://www.imsautoparts.com/mercedes-sprinter-w906-rear-bumper-corner-panel-right-os-free-reflector.*
 Black Outer End Bumper Cover Fits Volvo VNL Gen III. 2018. 4 State Trucks, https://www.4statetrucks.com/bumpers/semi-truck-black-outer-end-bumper-cover-fits-volvo-vnl-gen-iii-driver-passenger-side-replaces-82750588-82750590_236535.asp?childskumatch=13-0104022&gclid=EAlalQobChMI6ZeCkJfE9QIVAablCh2XngyvEAQYCCABEg.*
 Plastic Bumper End For 3 Piece Bumpers Fits International ProStar. Before May 21, 2020. 4 State Trucks. https://www.4statetrucks.com/bumpers/semi-truck-plastic-bumper-end-for-3-piece-bumpers-fits-international-prostar_200809.asp?childskumatch=07-010406&gclid=EAlalQobChMI6ZeCkJfE9QIVAablCh2XngyvEAQYAiABEgJs4fD_BwE.*

* cited by examiner

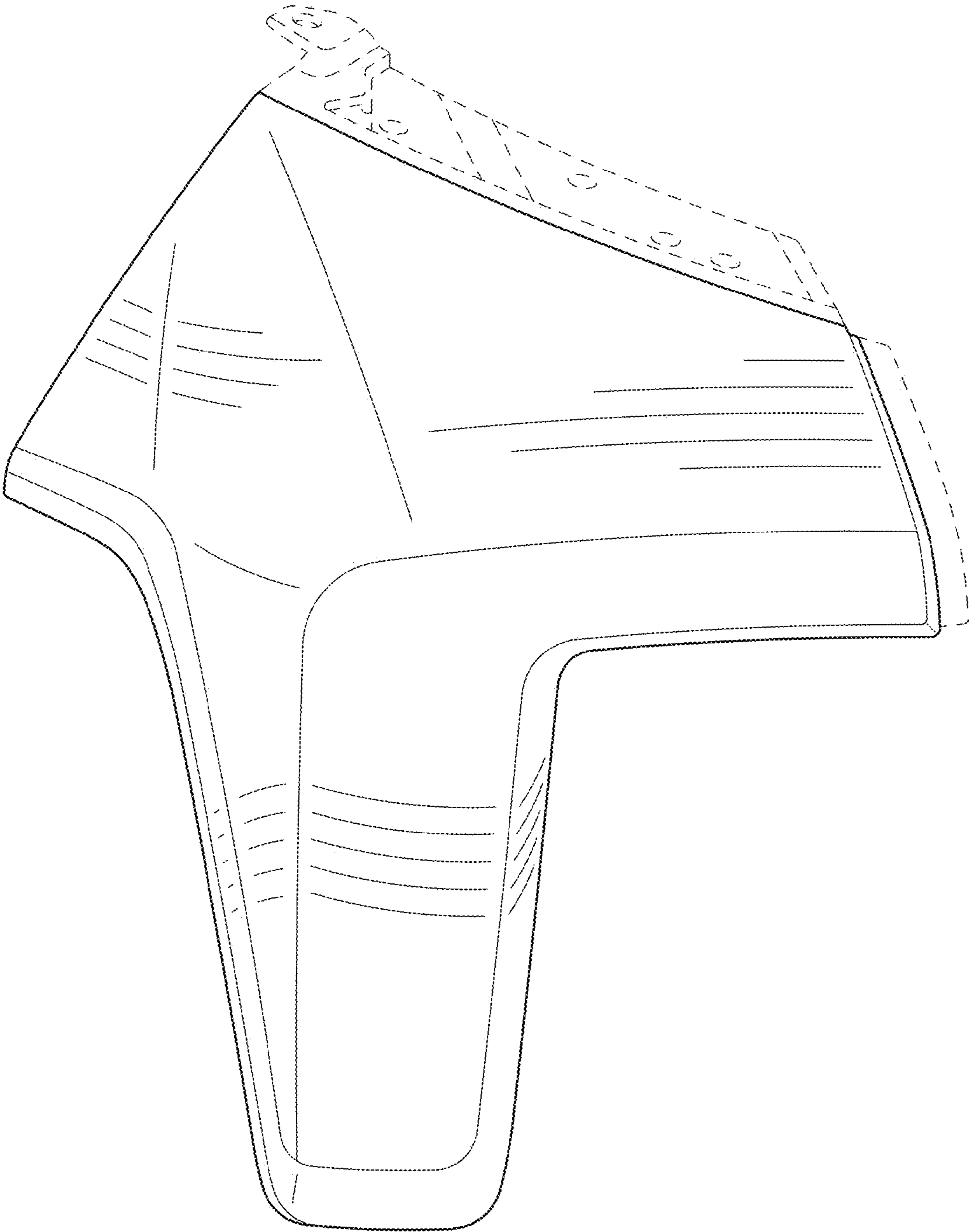

FIG. 1

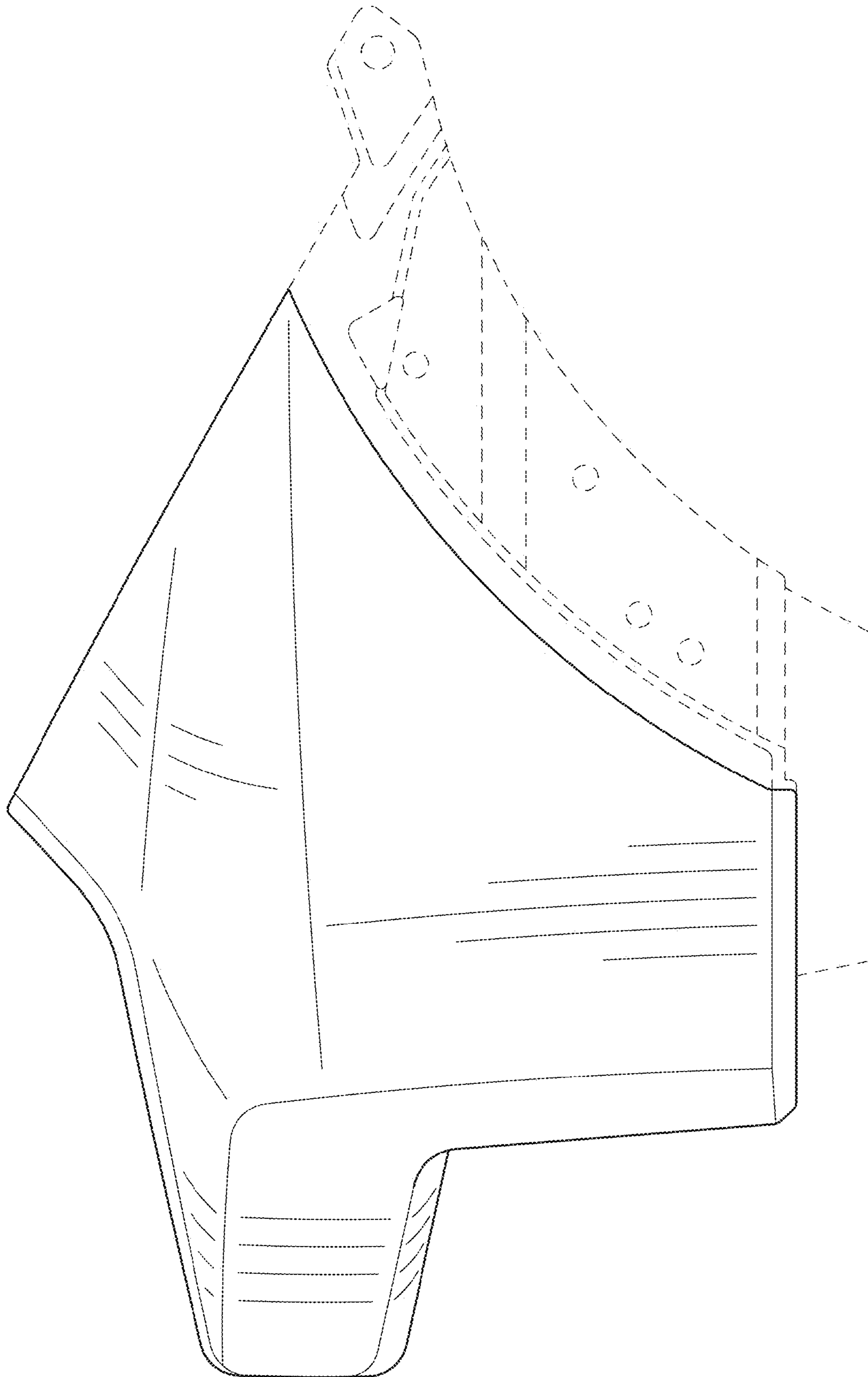

FIG. 2

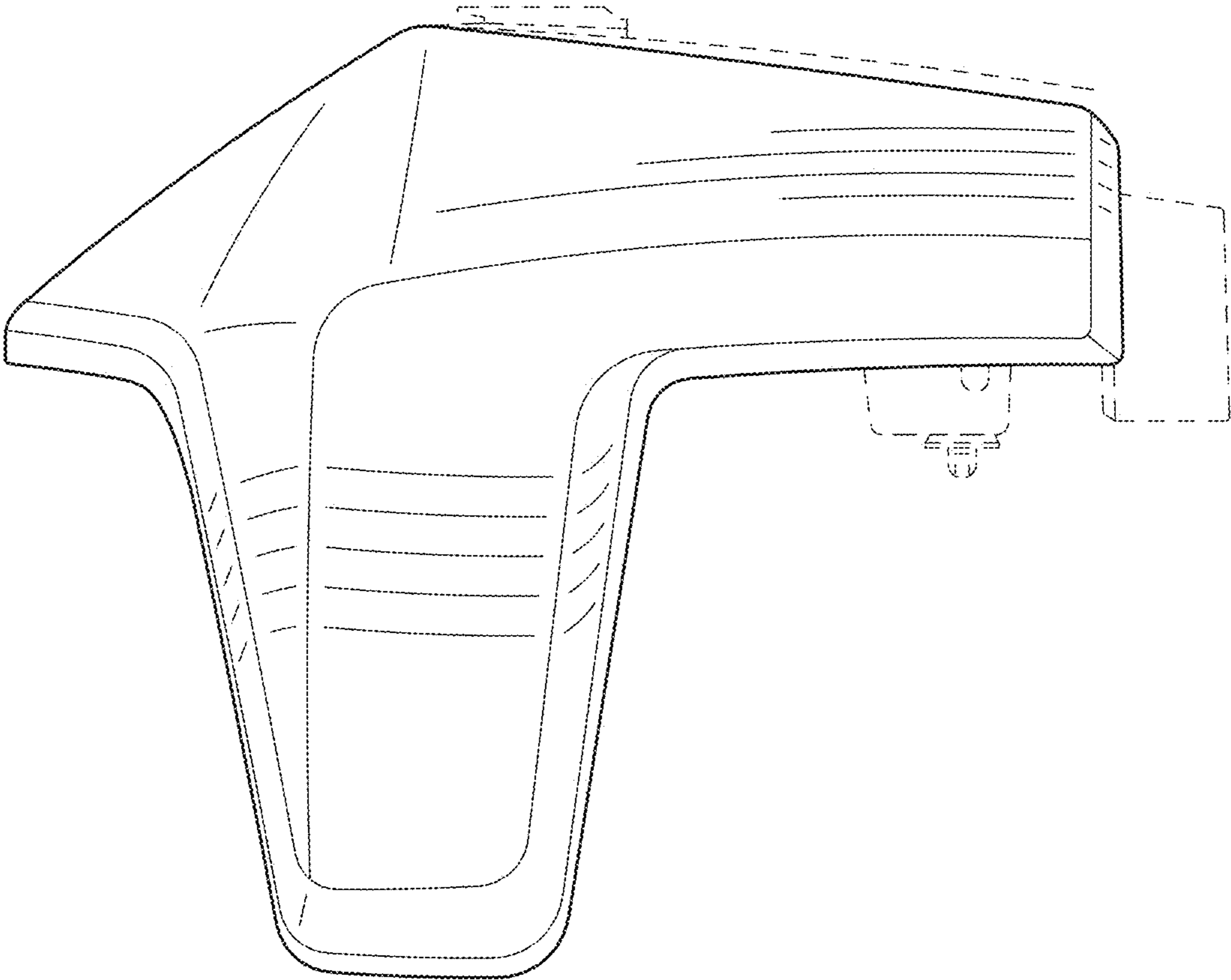

FIG. 3

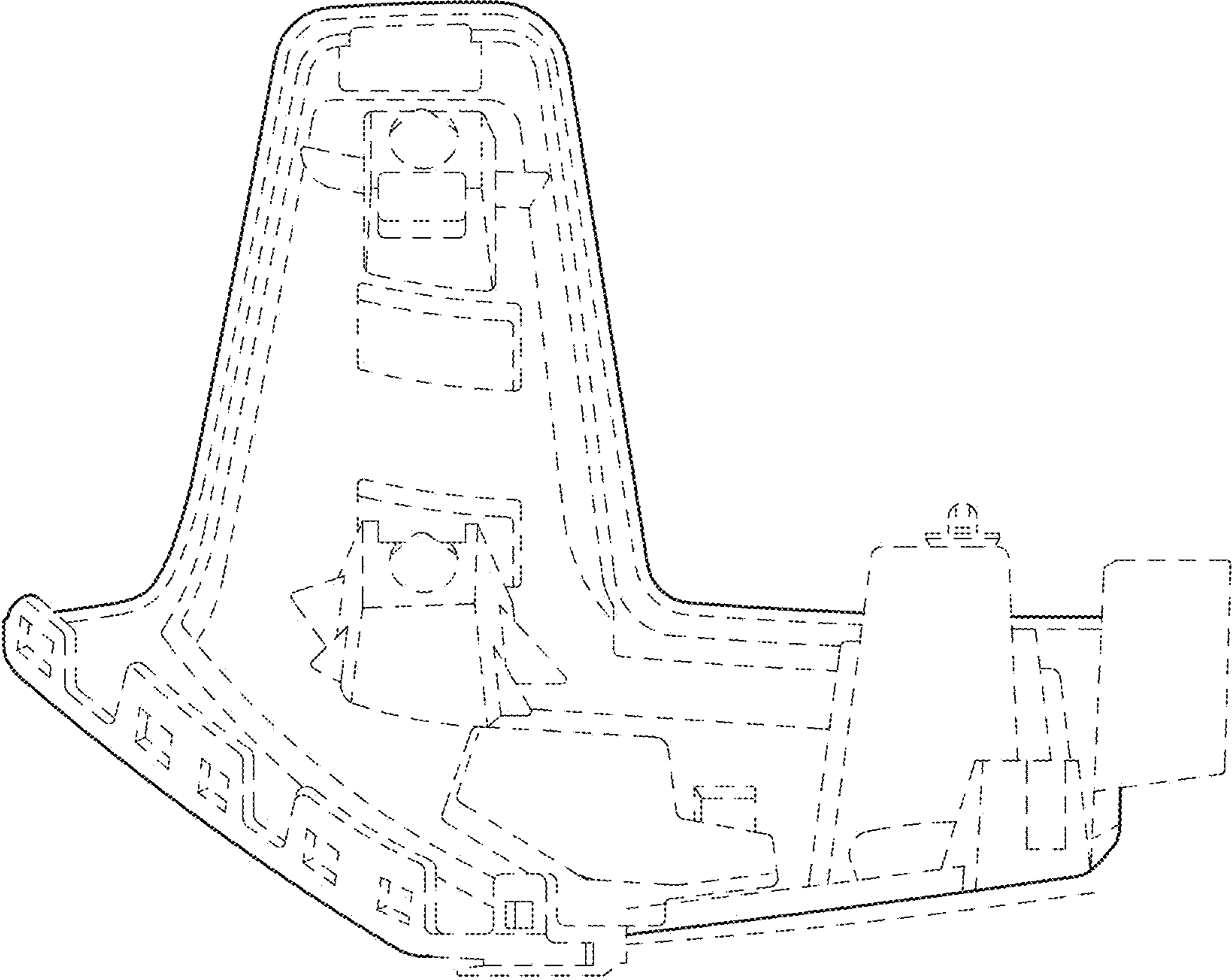

FIG. 4

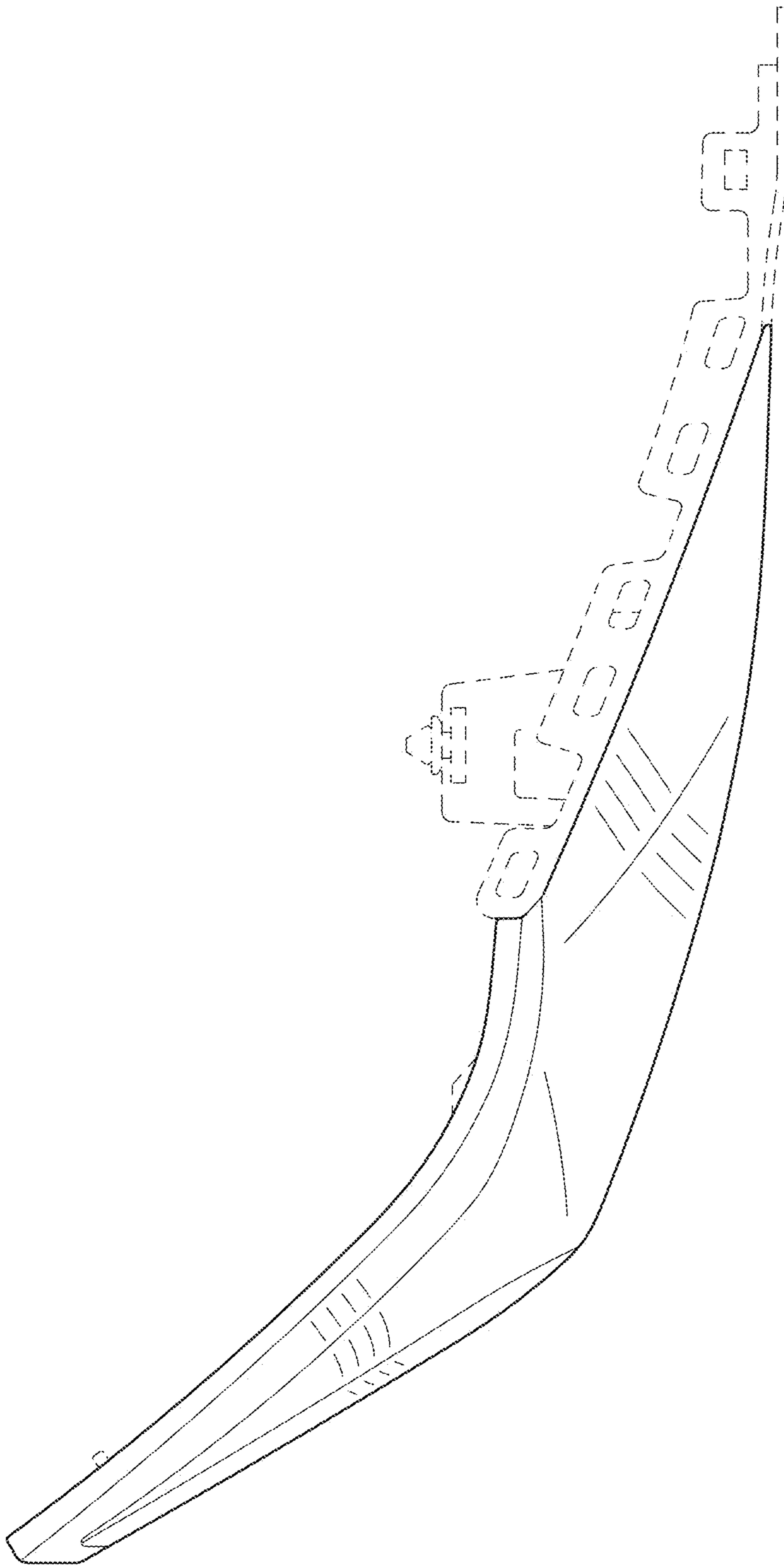

FIG. 5

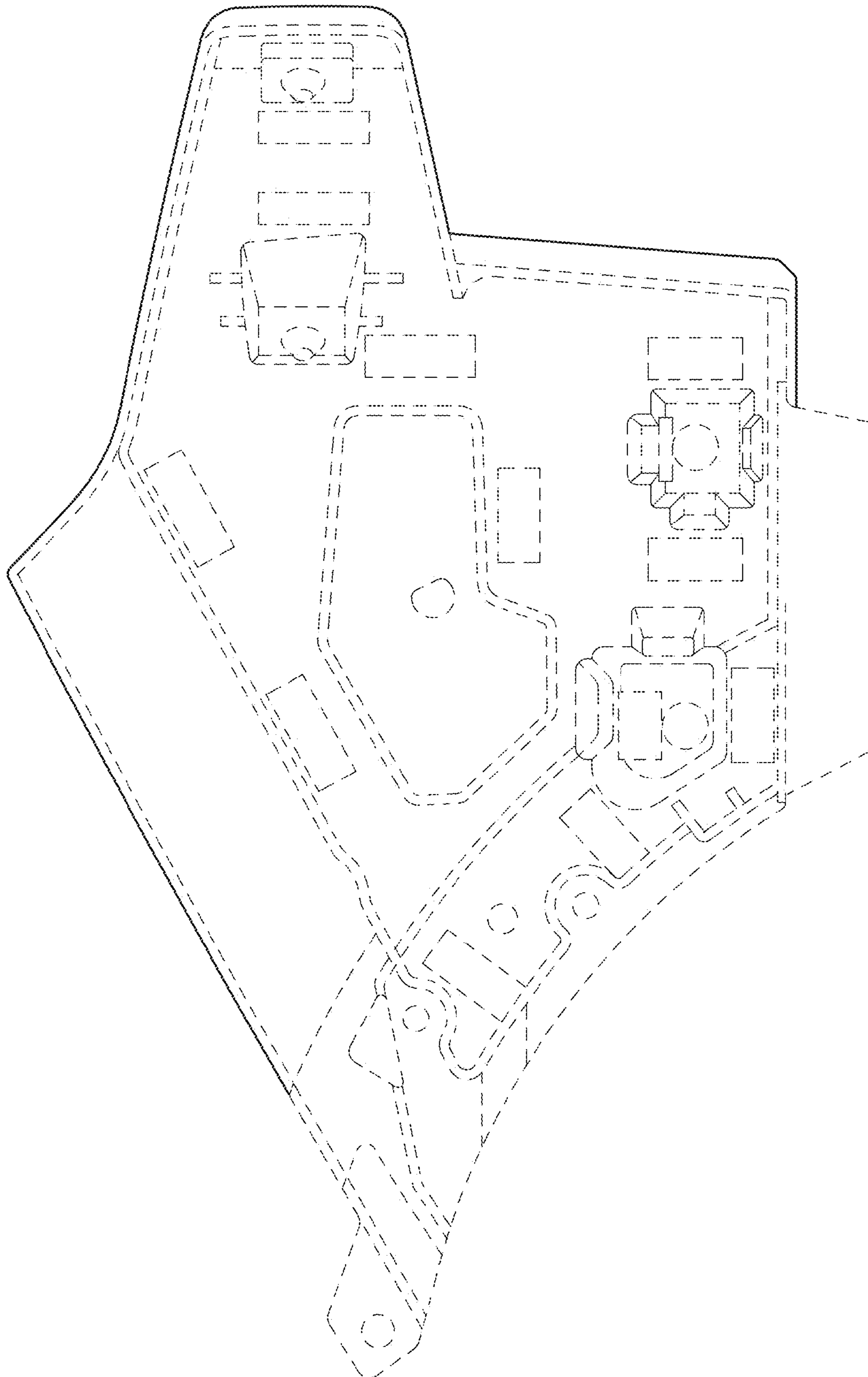

FIG. 6

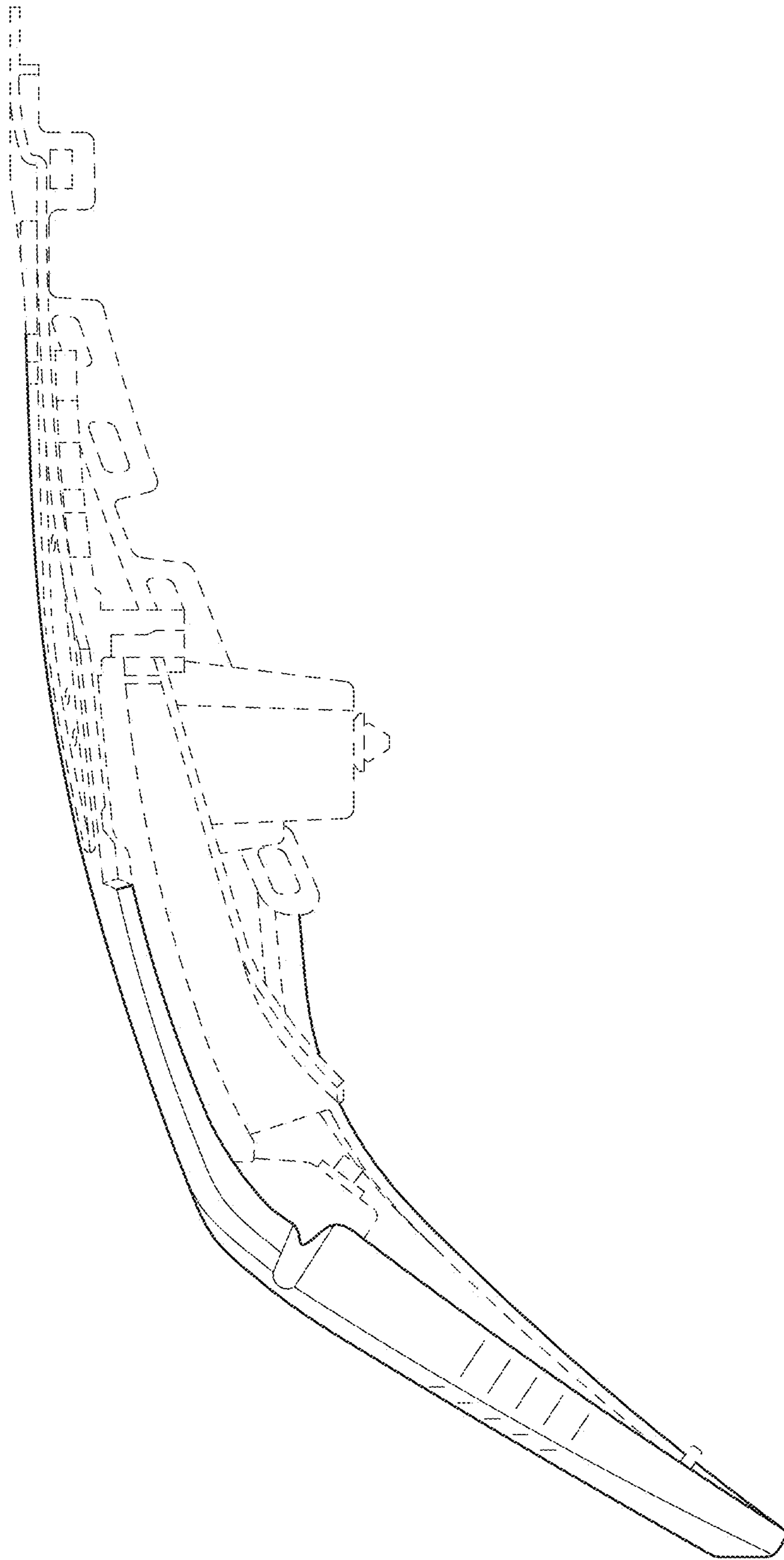

FIG. 7