



US00D950414S

(12) **United States Design Patent** (10) **Patent No.:** **US D950,414 S**  
**Faurote et al.** (45) **Date of Patent:** **\*\* \*May 3, 2022**

(54) **AUTOMOBILE**

(56) **References Cited**

(71) Applicant: **FCA US LLC**, Auburn Hills, MI (US)

U.S. PATENT DOCUMENTS

(72) Inventors: **Brandon L Faurote**, Rochester, MI (US); **Simeon W Kim**, Birmingham, MI (US); **Randy J Hjelm**, Oak Park, MI (US); **Gregory Vandervoord**, Clarkston, MI (US)

D615,905 S	*	5/2010	Arnell .....	D12/91
D619,931 S	*	7/2010	Arnell .....	D12/86
D640,602 S	*	6/2011	Yoshida .....	D12/91
D713,297 S	*	9/2014	Bose .....	D12/91
D820,161 S	*	6/2018	Dunford .....	D12/91
D836,026 S	*	12/2018	Renner .....	D12/86
D839,784 S	*	2/2019	Sugawara .....	D12/86
D890,028 S	*	7/2020	Radbrink .....	D12/91
D904,930 S	*	12/2020	Missoni .....	D12/86

(73) Assignee: **FCA US LLC**, Auburn Hills, MI (US)

\* cited by examiner

(\*) Notice: This patent is subject to a terminal disclaimer.

*Primary Examiner* — Melody N Brown

(\*\*) Term: **15 Years**

(74) *Attorney, Agent, or Firm* — Ralph E. Smith

(21) Appl. No.: **29/719,361**

(57) **CLAIM**

(22) Filed: **Jan. 3, 2020**

The ornamental design for an automobile, as shown and described.

**DESCRIPTION**

**Related U.S. Application Data**

(63) Continuation-in-part of application No. 29/717,427, filed on Dec. 17, 2019.

FIG. 1 is a side elevational view of an automobile showing our new design;

(51) **LOC (13) Cl.** ..... **12-08**

FIG. 2 is a front and side perspective view thereof;

(52) **U.S. Cl.**

FIG. 3 is a rear and side perspective view thereof;

USPC ..... **D12/91**; D12/86

FIG. 4 is a front elevational view thereof;

(58) **Field of Classification Search**

USPC ..... D12/86, 90-92, 88, 164; D21/424, 433, D21/434; 296/181.1-181.5, 183.1

FIG. 5 is an opposite side elevational view thereof;

CPC ..... B62D 25/00; B62D 25/06; B62D 33/00; B62D 35/00

FIG. 6 is a rear and opposite side perspective view thereof;

See application file for complete search history.

FIG. 7 is a rear elevational view thereof; and,

FIG. 8 is a top plan view thereof.

It will be understood that the broken lines shown in the drawings illustrate portions of the automobile that form no part of the claimed design.

**1 Claim, 8 Drawing Sheets**

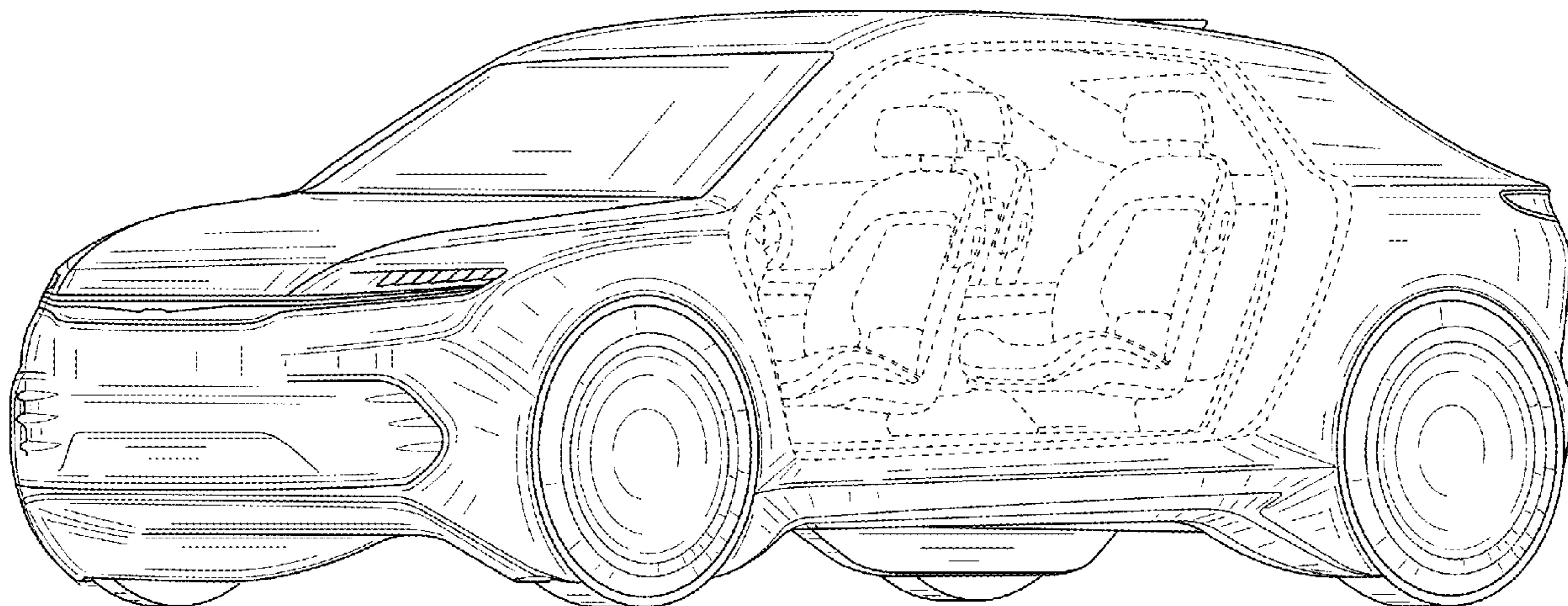

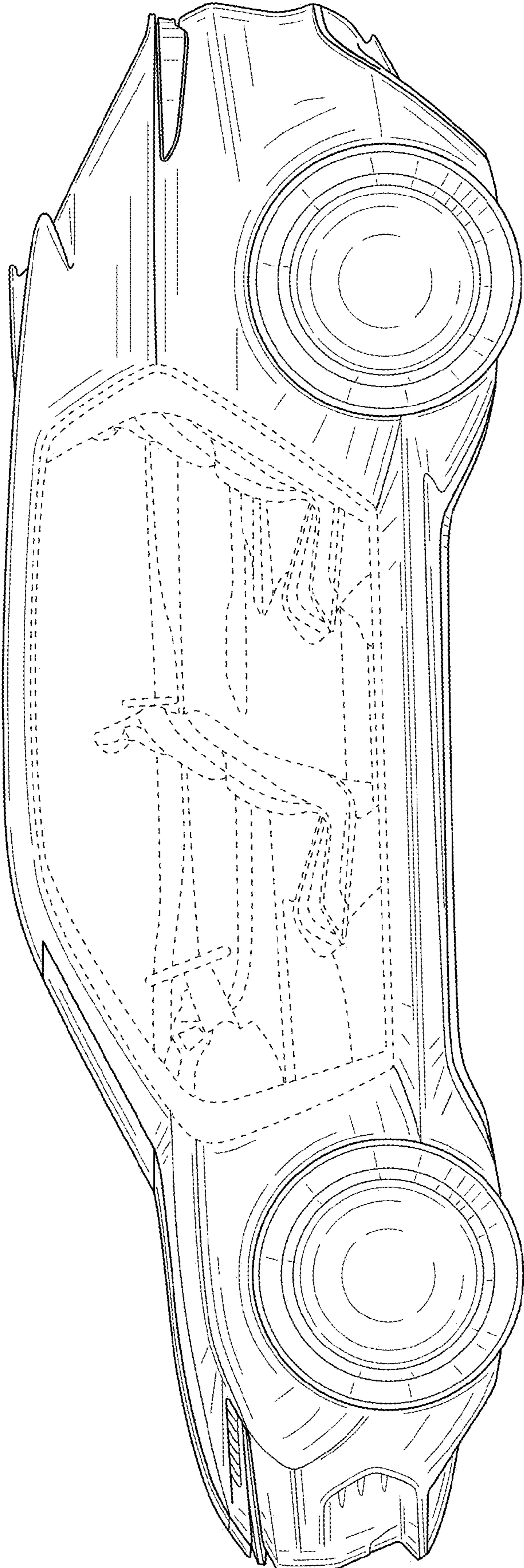

FIG. 1

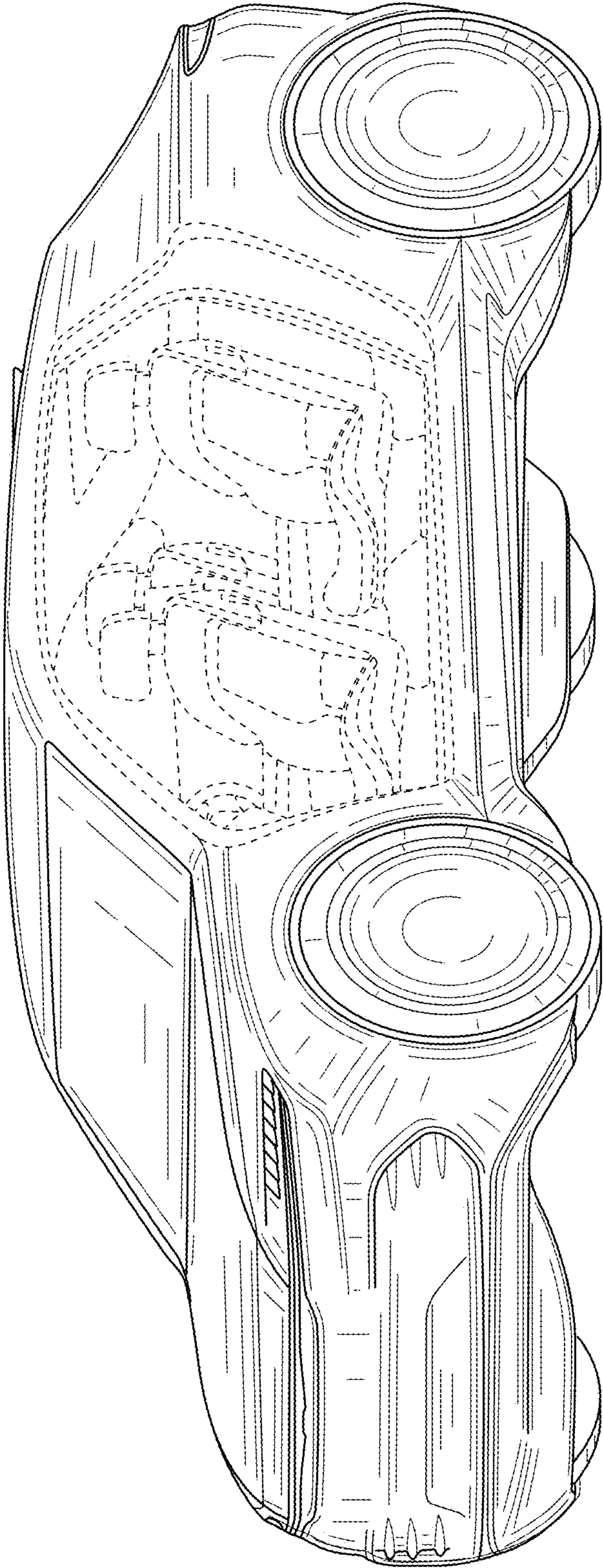

FIG. 2

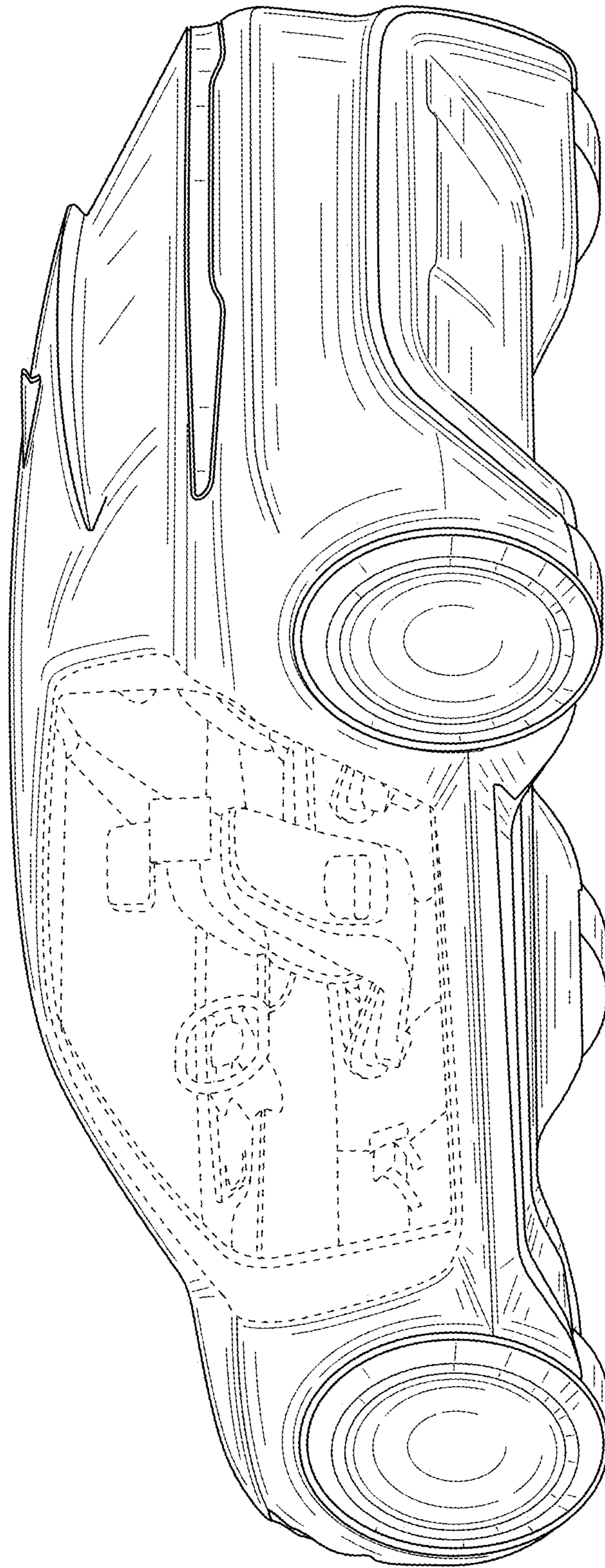

FIG. 3

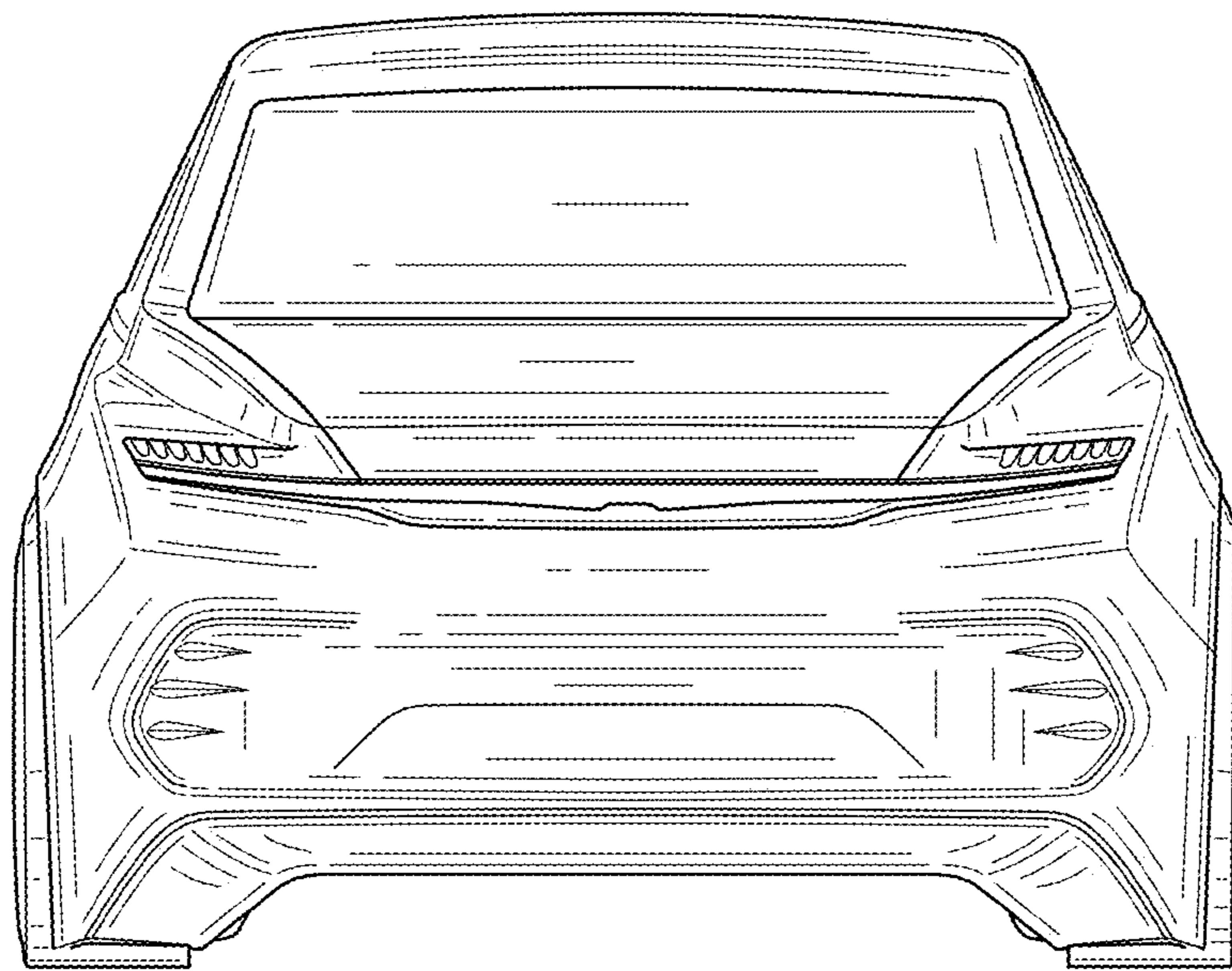

FIG. 4

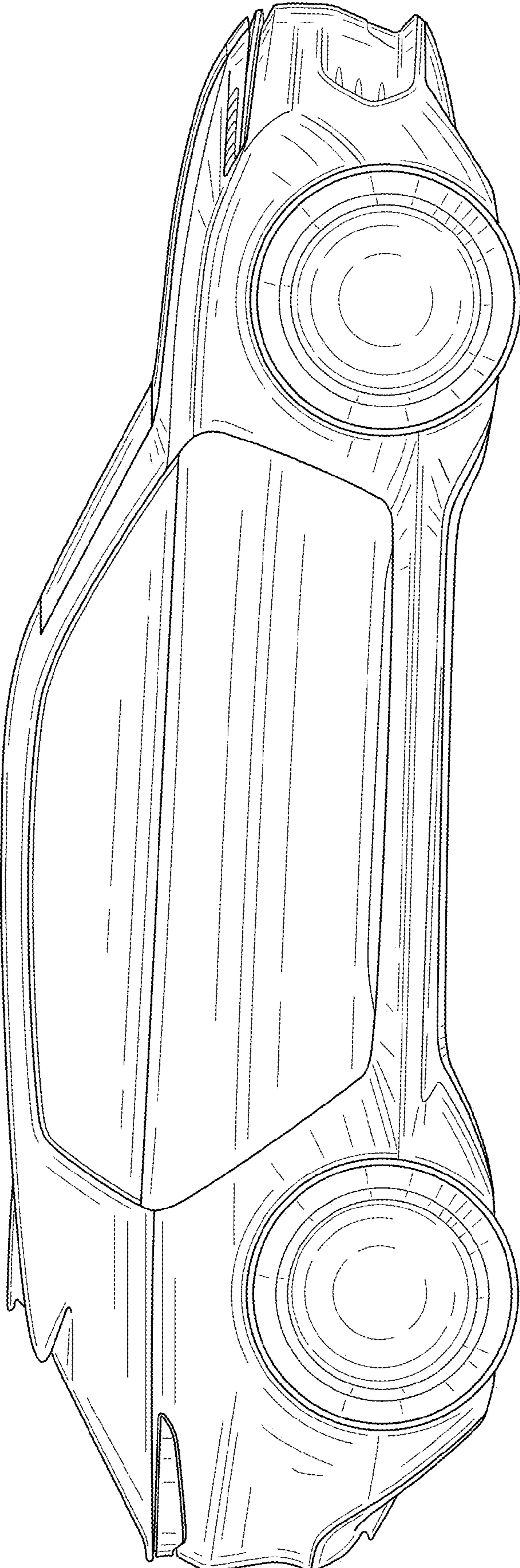

FIG. 5

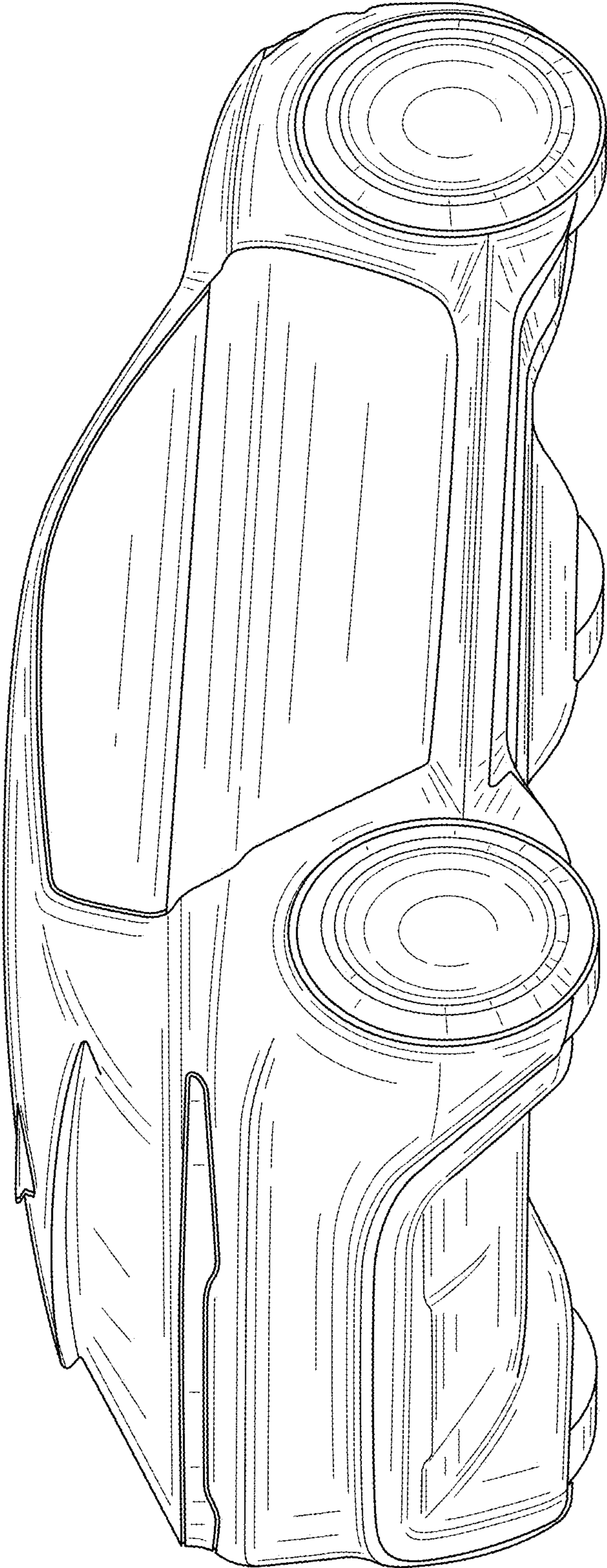

FIG. 6

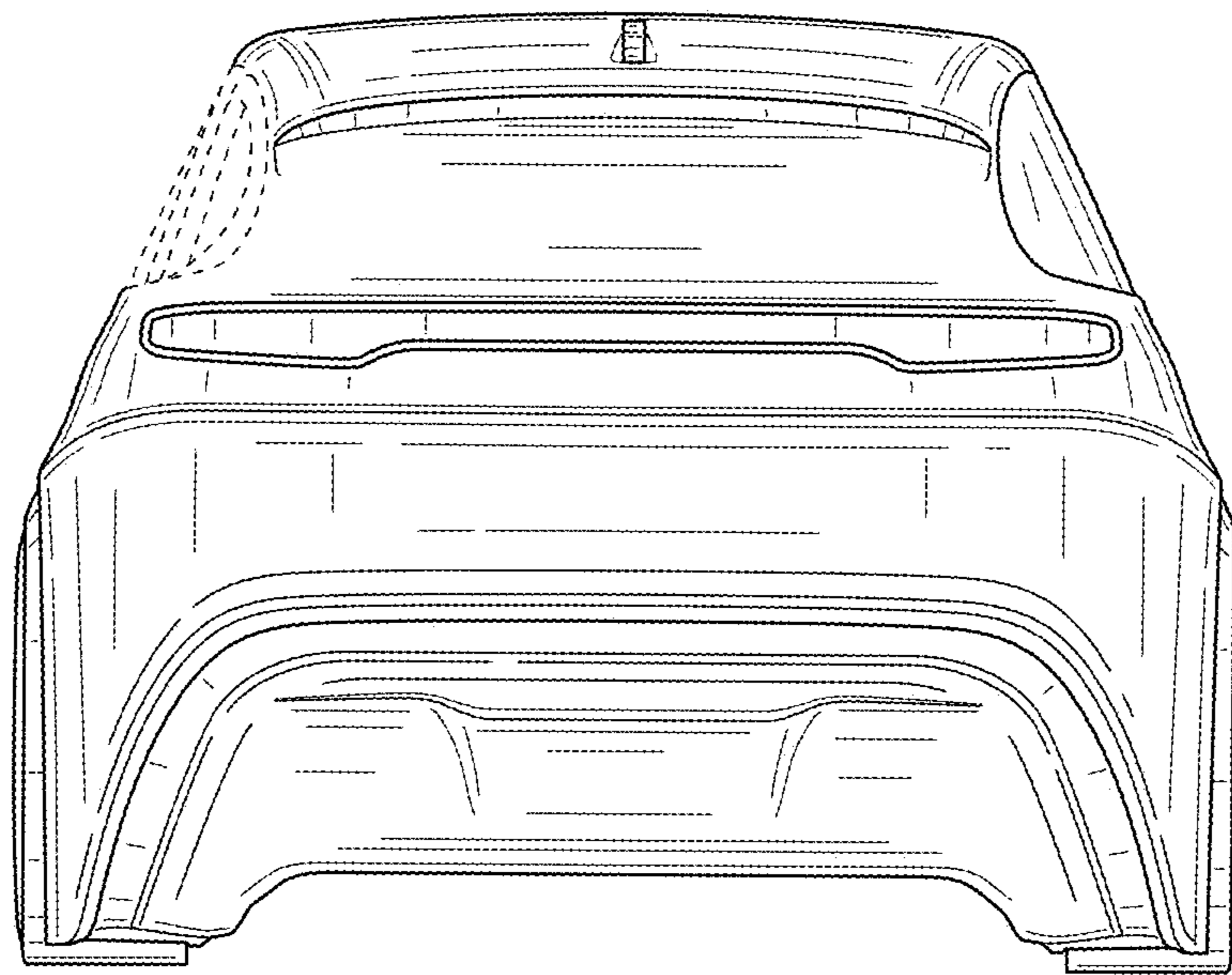

FIG. 7



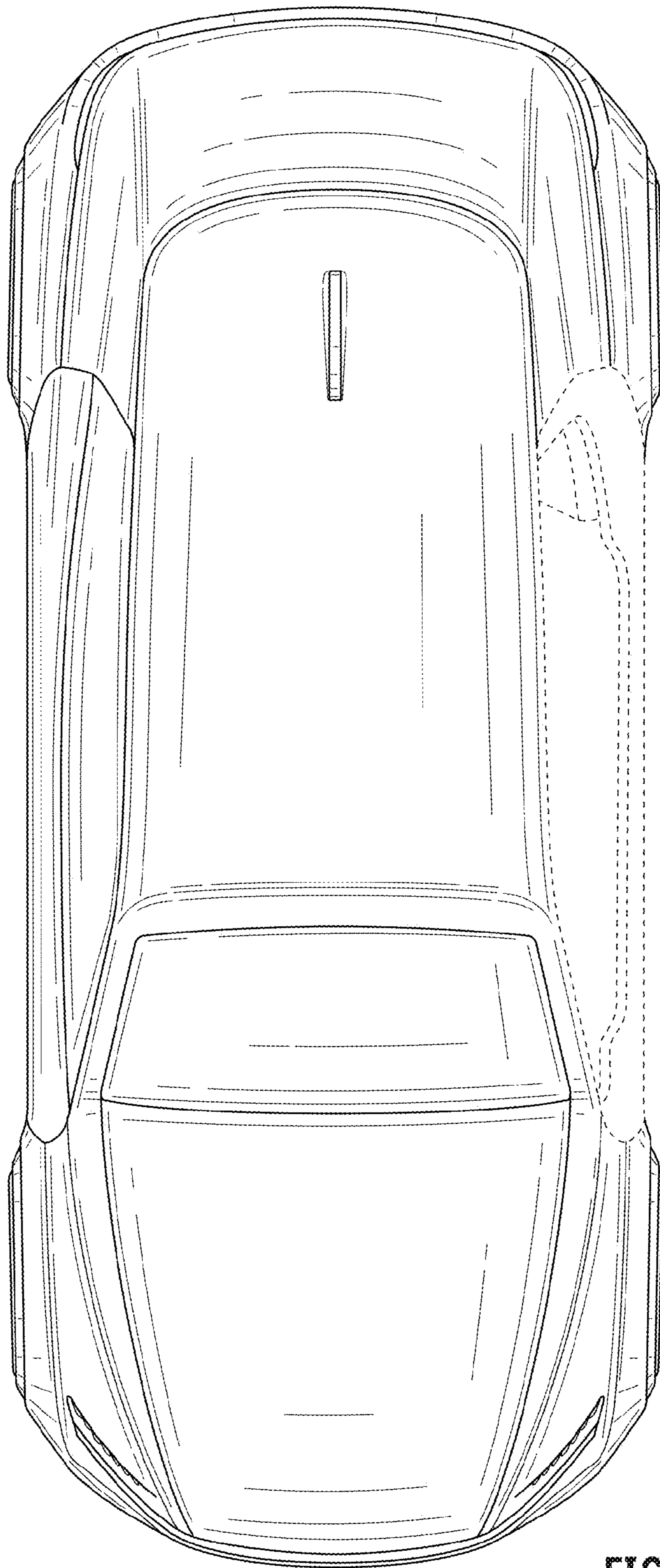

FIG. 8