



US00D950392S

(12) **United States Design Patent**
Tsuruta

(10) **Patent No.:** **US D950,392 S**

(45) **Date of Patent:** **** May 3, 2022**

(54) **BAG FOR PACKAGING**

(71) Applicant: **ORIHIRO Plantdew Co., Ltd.**, Gunma (JP)

(72) Inventor: **Orihiro Tsuruta**, Takasaki (JP)

(**) Term: **15 Years**

(21) Appl. No.: **35/511,294**

(22) Filed: **Aug. 4, 2020**

(80) **Hague Agreement Data**

Int. Filing Date: **Aug. 4, 2020**

Int. Reg. No.: **DM/209890**

Int. Reg. Date: **Aug. 4, 2020**

Int. Reg. Pub. Date: **Feb. 5, 2021**

(51) **LOC (13) Cl.** **09-05**

(52) **U.S. Cl.**
USPC **D9/703**

(58) **Field of Classification Search**

USPC D9/703, 702, 707-710, 416; D7/602

CPC B65D 75/5811; B65D 33/22; B65D 85/72;

B65D 31/16; A23L 21/10

See application file for complete search history.

(56) **References Cited**

U.S. PATENT DOCUMENTS

D594,752 S * 6/2009 Medema D9/707

D747,975 S * 1/2016 Gillespie D9/707

9,718,593 B2 * 8/2017 Gillespie B65D 75/5866

D831,499 S * 10/2018 Hardy D9/707

D874,942 S * 2/2020 Tsuruta D9/703

D922,880 S * 6/2021 Markoulis D9/707
D940,566 S * 1/2022 Pellingra D9/707
2021/0122550 A1 * 4/2021 Tsuruta B65D 85/72

* cited by examiner

Primary Examiner — Michael A. Pratt

(57) **CLAIM**

The ornamental design for a packaging bag, as shown and described.

DESCRIPTION

1.-2. Bag for packaging

1.1 : Perspective

1.2 : Front

1.3 : Back

1.4 : Top

1.5 : Bottom

1.6 : Left

1.7 : Right

2.1 : Perspective

2.2 : Front

2.3 : Back

2.4 : Top

2.5 : Bottom

2.6 : Left

2.7 : Right

Design 1 and 2 are packaging bags for jelly, paste or liquid contents; this packaging bag is formed by heat-sealing a part of the resin film; it can be opened at least half of its width by tearing the heat seal in the width direction from the upper notch; the parallel thin lines and the radial thin lines in the representation represent contours only and do not illustrate an ornamentation or decoration on the surface of the product.

1 Claim, 14 Drawing Sheets

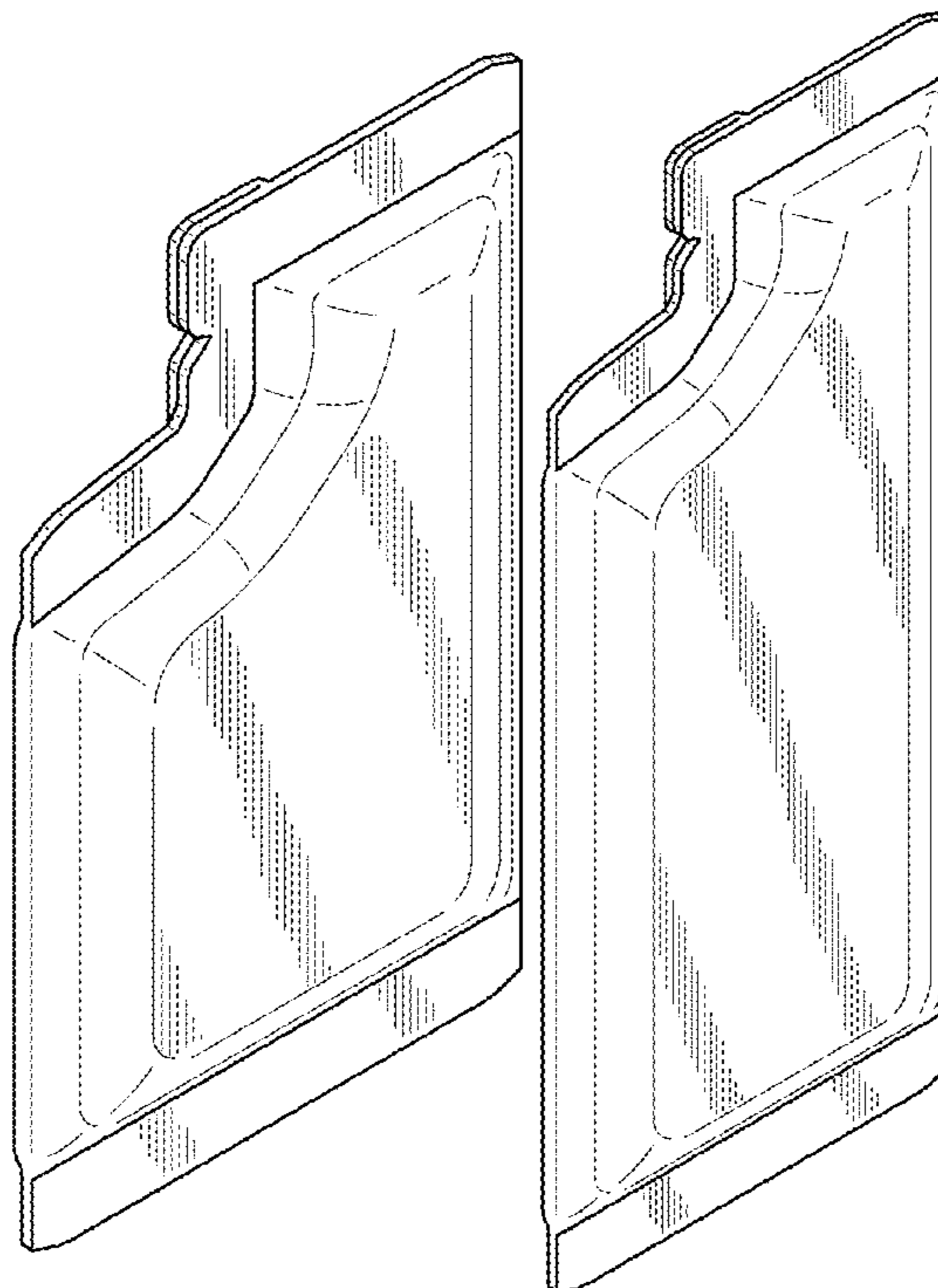

1.1

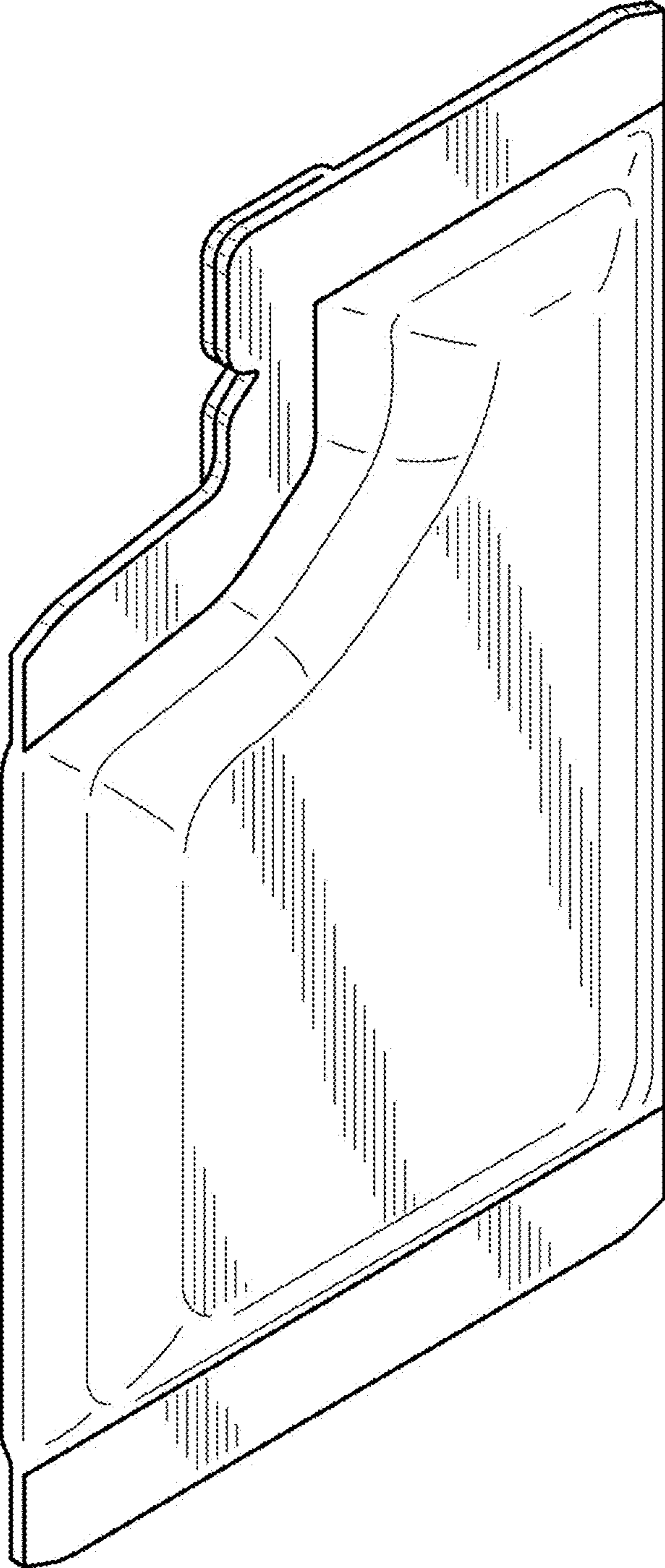

1.2

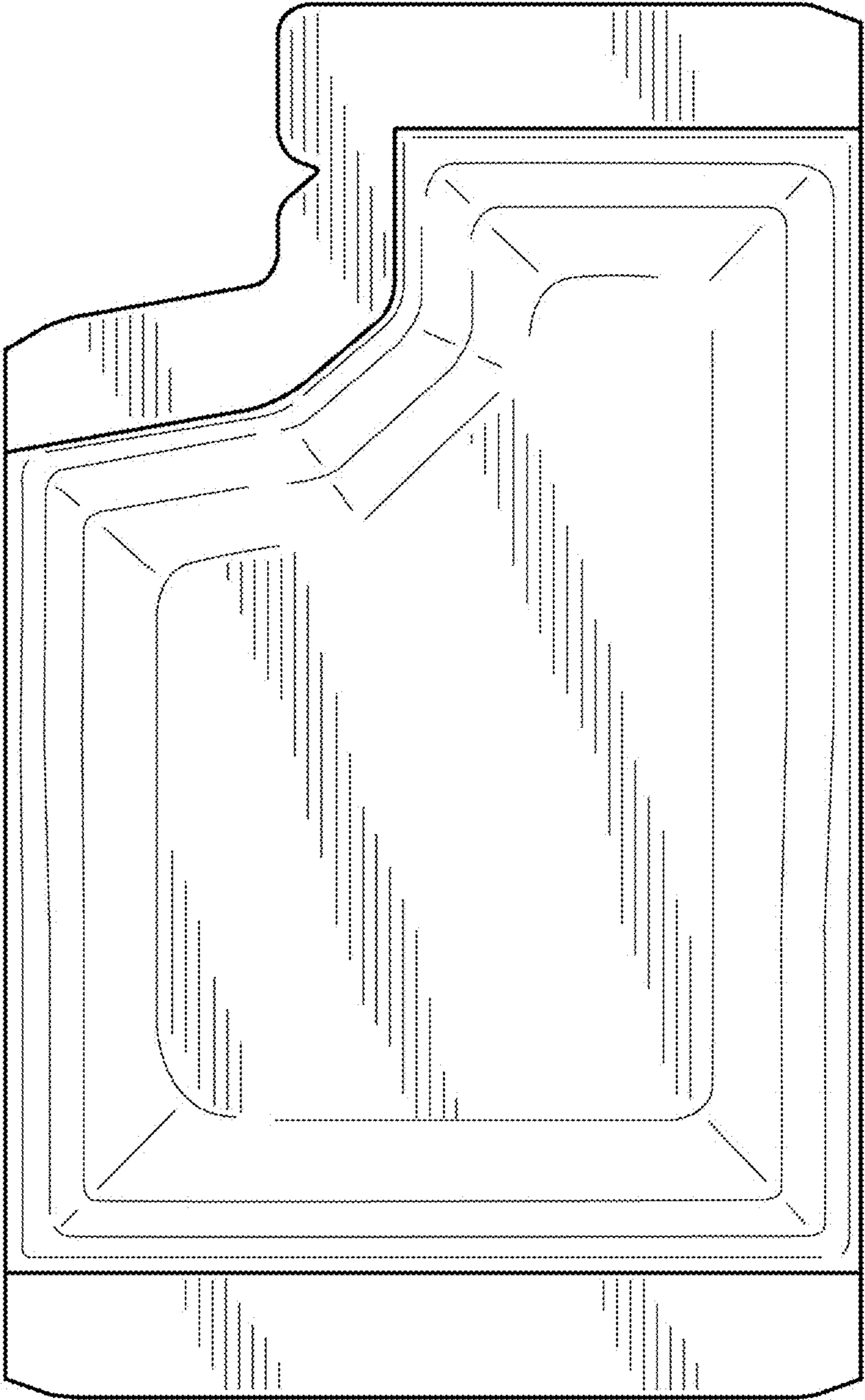

1.3

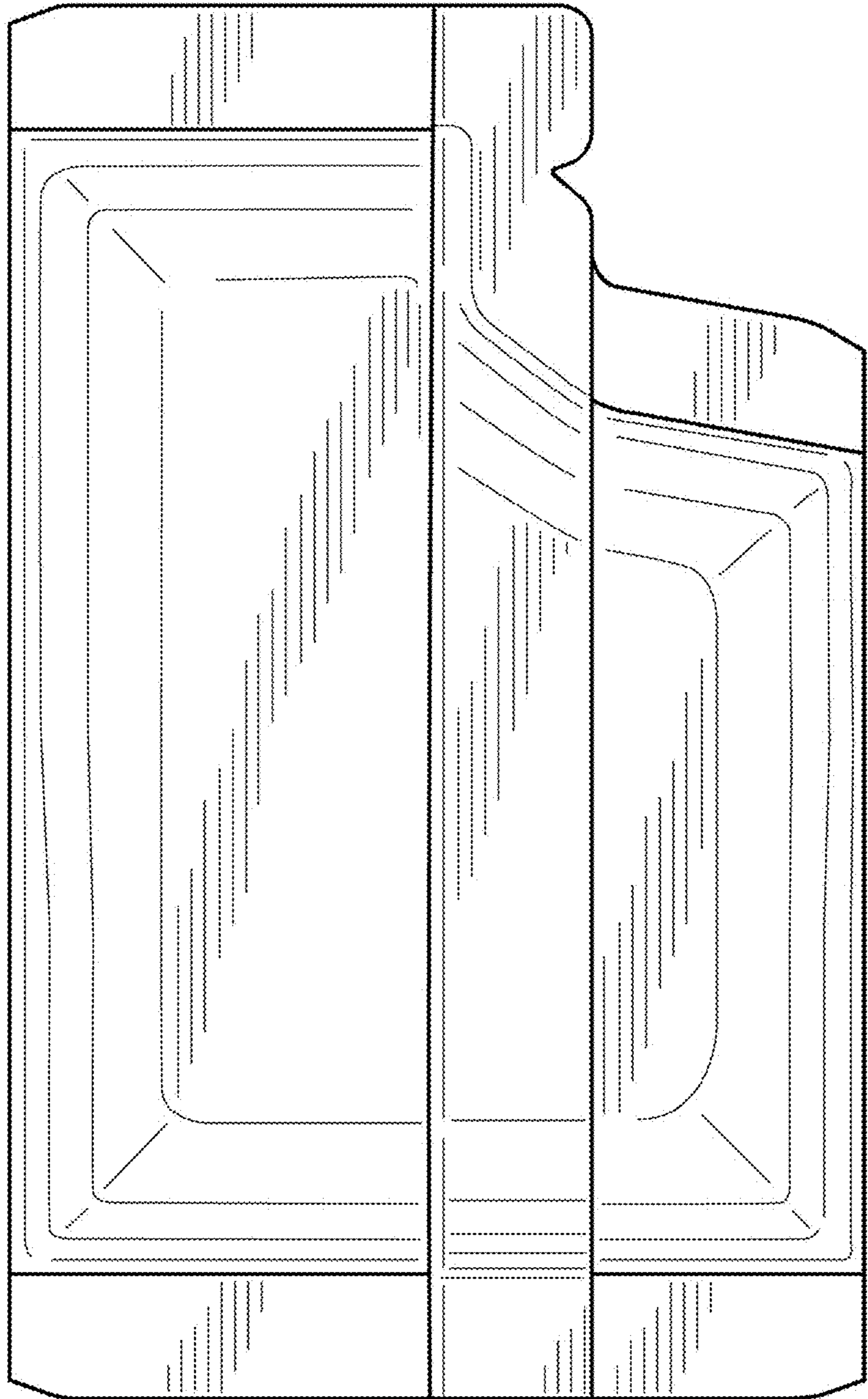

1.4

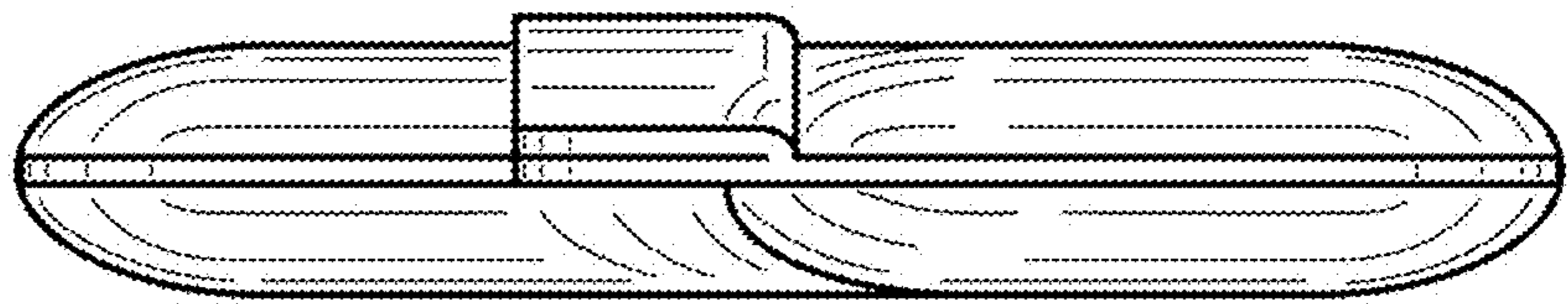

1.5

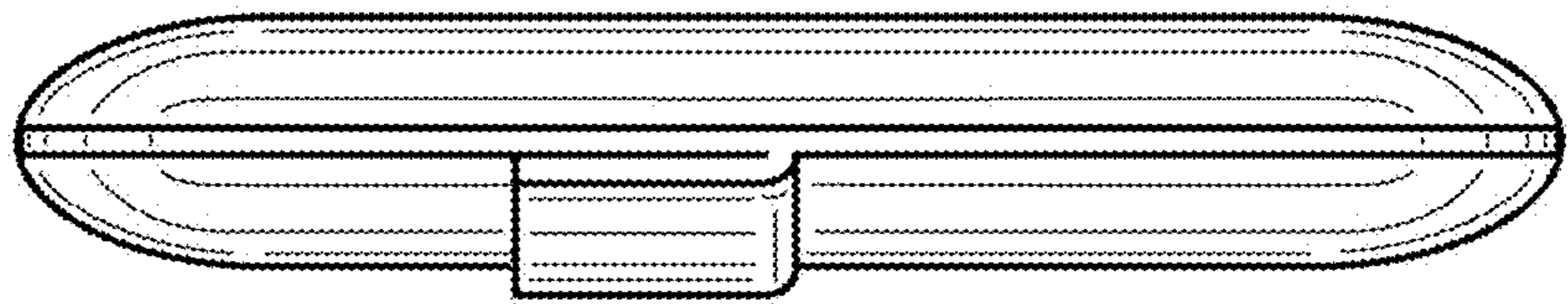

1.6

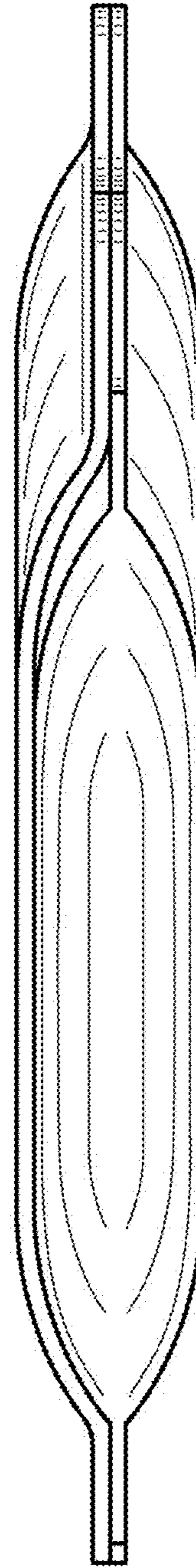

1.7

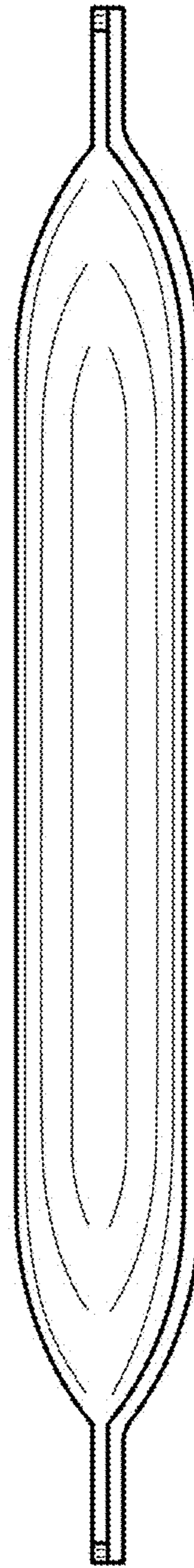

2.1

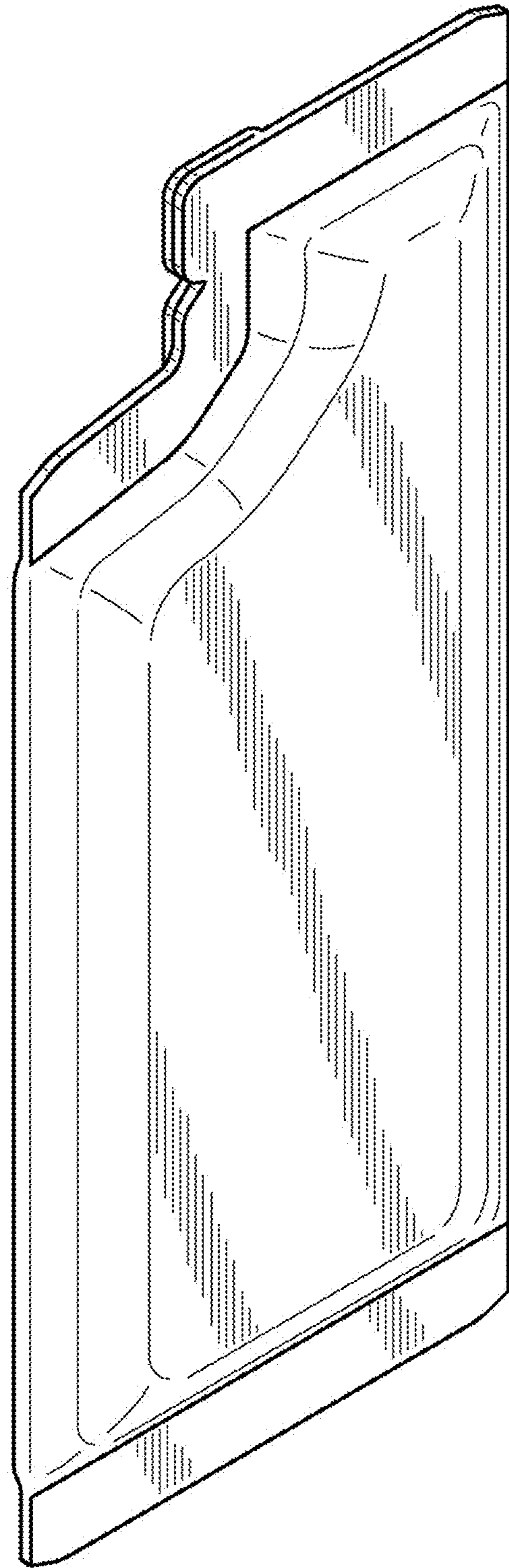

2.2

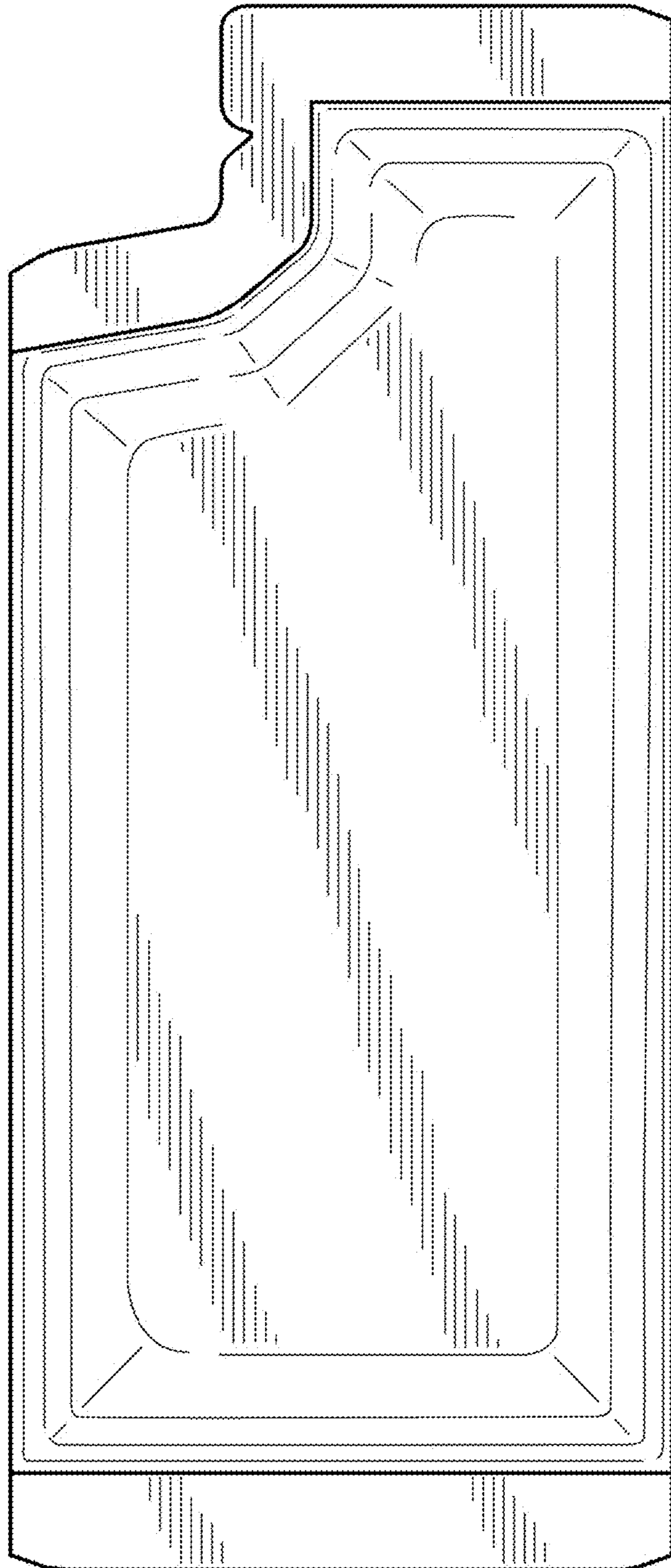

2.3

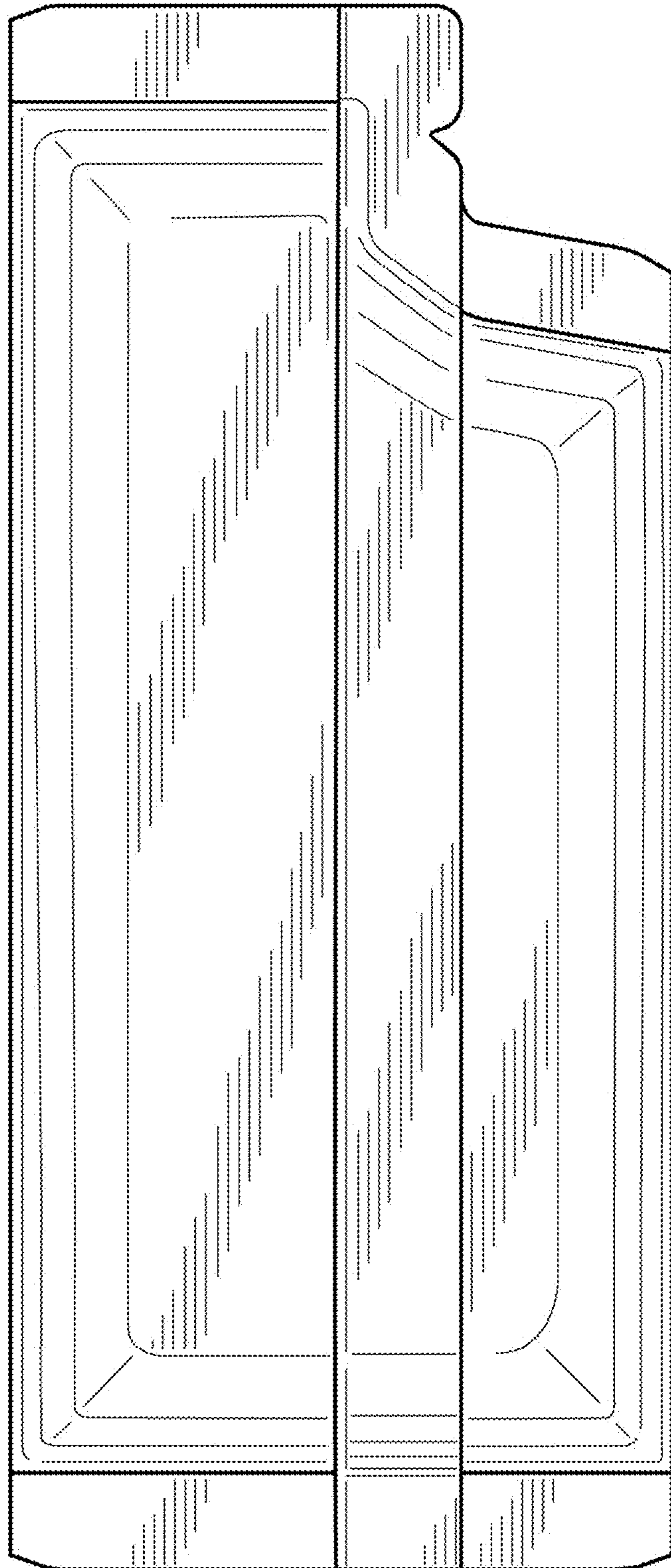

2.4

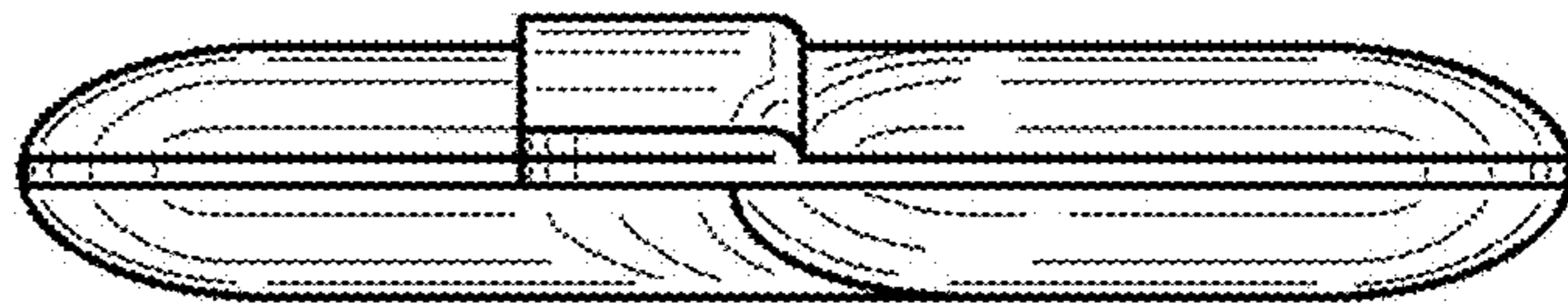

2.5

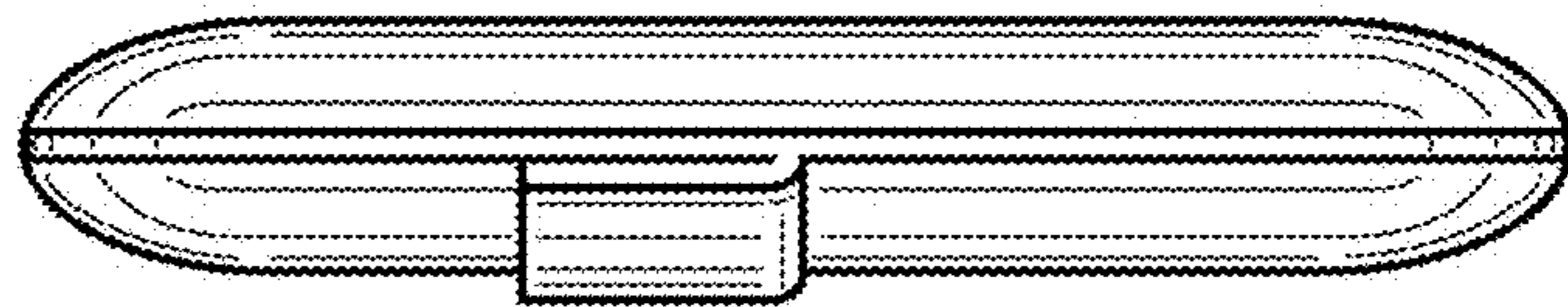

2.6

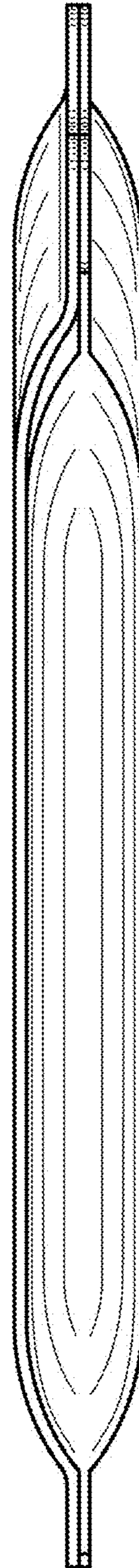

2.7

