



US00D950279S

(12) **United States Design Patent** (10) **Patent No.:** **US D950,279 S**  
**Groglopo Favetto et al.** (45) **Date of Patent:** **\*\* May 3, 2022**

(54) **STORAGE FURNITURE**

(71) Applicant: **Conopco Inc.**, Englewood Cliffs, NJ (US)

(72) Inventors: **Pablo Ignacio Groglopo Favetto**, Rotterdam (NL); **Robin Michiel Hoenderdos**, Delft (NL); **Jeroen Klaasjan Verbrugge**, Delft (NL)

(73) Assignee: **Conopco Inc.**, Englewood Cliffs, NJ (US)

(\*\*) Term: **15 Years**

(21) Appl. No.: **29/699,125**

(22) Filed: **Jul. 23, 2019**

(30) **Foreign Application Priority Data**

Jan. 25, 2019 (EP) ..... 006084166-0001  
Jan. 25, 2019 (EP) ..... 006084166-0002  
Jan. 25, 2019 (EP) ..... 006084166-0005

(51) **LOC (13) Cl.** ..... **06-04**

(52) **U.S. Cl.**  
USPC ..... **D6/671.1**

(58) **Field of Classification Search**  
USPC ..... D6/671, 671.1, 671.2, 675.1  
(Continued)

(56) **References Cited**

**U.S. PATENT DOCUMENTS**

633,318 A \* 9/1899 Horle ..... A47B 88/941  
312/330.1  
846,881 A \* 3/1907 Walton ..... A47B 87/02  
312/107

(Continued)

**OTHER PUBLICATIONS**

“EXPECTIT 1.0—wooden box insert.” Found online Oct. 4, 2021 at [www.etsy.com](http://www.etsy.com). Product reviewed Apr. 30, 2020. Retrieved from URL: <https://tinyurl.com/nz53t44s> (Year: 2020).\*

(Continued)

*Primary Examiner* — Mary Ann Calabrese

*Assistant Examiner* — Katelin G Kloberg

(74) *Attorney, Agent, or Firm* — N.V. Nederlandsch Octrooibureau

(57) **CLAIM**

The ornamental design for a storage furniture, as shown and described.

**DESCRIPTION**

FIG. 1 is a top, front, right side perspective view of a storage furniture, showing a first embodiment of our new design; FIG. 2 is a front elevation view thereof; FIG. 3 is a right side elevation view thereof; FIG. 4 is a left side elevation view thereof; FIG. 5 is a rear elevation view thereof; FIG. 6 is a top plan view thereof; FIG. 7 is a bottom plan view thereof; FIG. 8 is a top, front, right side perspective view of a storage furniture, showing a second embodiment of our new design; FIG. 9 is a front elevation view thereof; FIG. 10 is a right side elevation view thereof; FIG. 11 is a left side elevation view thereof; FIG. 12 is a rear elevation view thereof; FIG. 13 is a top plan view thereof; FIG. 14 is a bottom plan view thereof; FIG. 15 is a top, front, right side perspective view of a storage furniture, showing a third embodiment of our new design; FIG. 16 is a front elevation view thereof; FIG. 17 is a right side elevation view thereof; FIG. 18 is a left side elevation view thereof; FIG. 19 is a rear elevation view thereof; FIG. 20 is a top plan view thereof; and, FIG. 21 is a bottom plan view thereof.

**1 Claim, 21 Drawing Sheets**

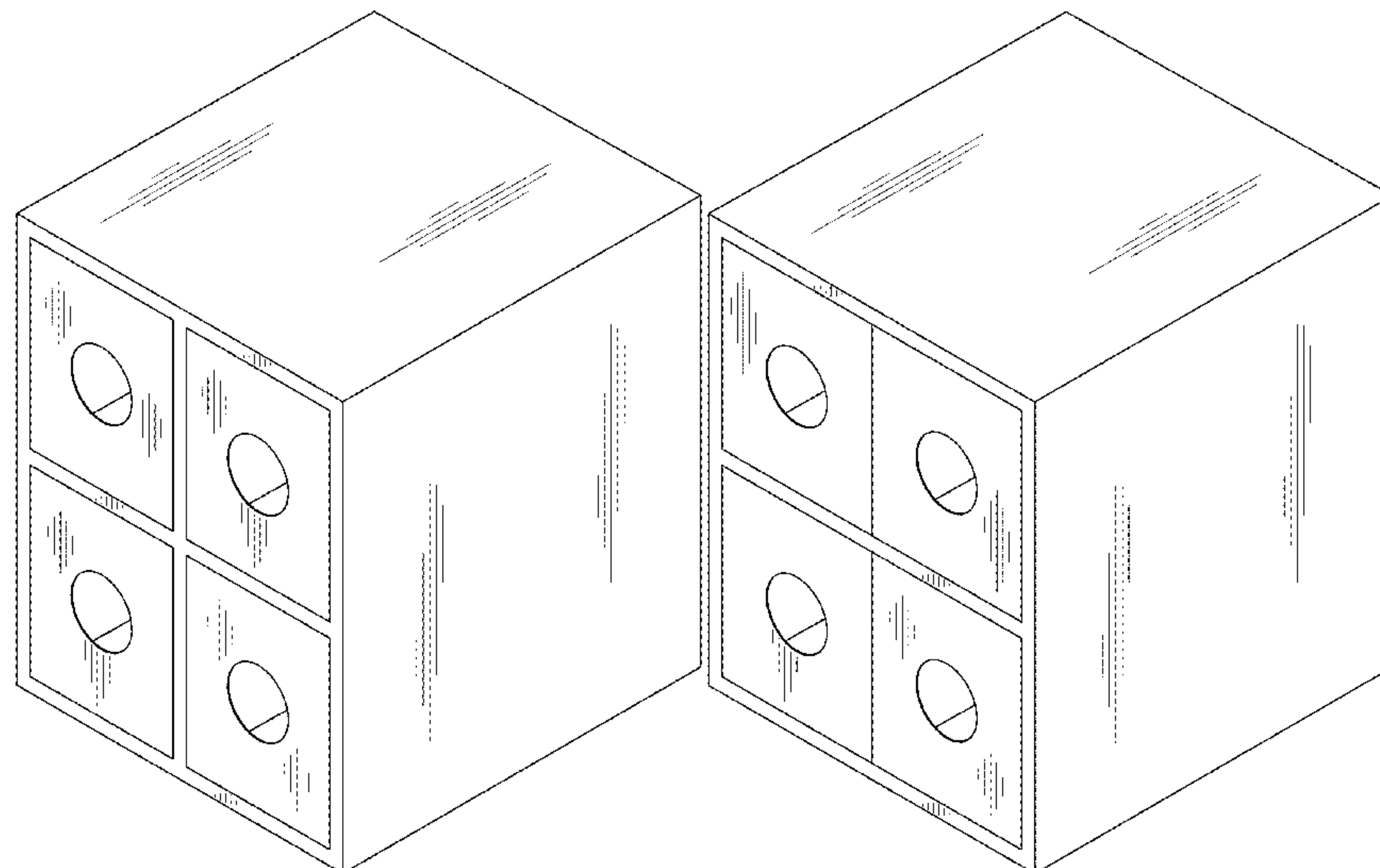

(58) **Field of Classification Search**

CPC ..... B65G 65/38; B65G 2201/0244; A47B  
73/00; A47B 96/20; A47B 2220/0077  
See application file for complete search history.

(56) **References Cited**

U.S. PATENT DOCUMENTS

2,121,190 A \* 6/1938 Fellowes ..... A47B 87/02  
312/108  
D119,582 S \* 3/1940 Williams ..... D6/675.1  
D150,722 S \* 8/1948 Neville ..... D6/671.2  
2,482,174 A \* 9/1949 Elmerc ..... A47B 87/02  
312/111  
3,554,384 A \* 1/1971 DeNatale ..... A47B 87/0276  
211/194  
D227,060 S \* 6/1973 Jiranek ..... D6/671.1  
3,837,299 A \* 9/1974 McClellan ..... A47B 96/04  
109/56  
D239,063 S \* 3/1976 Sgombick ..... D6/671  
D239,064 S \* 3/1976 Sgombick ..... D6/671  
D239,065 S \* 3/1976 Sgombick ..... D6/671  
D275,626 S \* 9/1984 Moore ..... D6/675.1  
D333,931 S \* 3/1993 Wein ..... D6/675.1  
D334,815 S \* 4/1993 Bunger ..... D21/501  
D339,253 S \* 9/1993 Garnick ..... D6/661  
D379,631 S \* 6/1997 Odom ..... D15/86  
D437,706 S \* 2/2001 Alcala ..... D6/671  
D587,933 S \* 3/2009 Semrau ..... D6/671  
D598,216 S \* 8/2009 Wong ..... D6/661  
D647,325 S \* 10/2011 Gormezano ..... D6/671.1  
8,113,600 B2 \* 2/2012 Zalewski ..... A47B 47/0041  
312/111  
D669,921 S \* 10/2012 Kinser ..... D15/89

8,432,701 B2 \* 4/2013 Katano ..... A47B 67/04  
361/732  
D719,380 S \* 12/2014 Ward ..... D6/675.1  
9,595,241 B2 \* 3/2017 Zhu ..... G07F 17/0092  
D913,022 S \* 3/2021 Li ..... D6/675.1  
D914,801 S \* 3/2021 Stecklein ..... D19/62  
D918,055 S \* 5/2021 Smith, Jr. .... D9/636  
2004/0055980 A1 \* 3/2004 Krieger ..... A47B 45/00  
211/86.01  
2004/0104187 A1 \* 6/2004 McCain ..... A47F 7/28  
211/75  
2004/0263031 A1 \* 12/2004 Irizarry ..... A47B 87/0284  
312/330.1  
2009/0152222 A1 \* 6/2009 Seldon ..... F16B 12/26  
211/74  
2019/0150614 A1 \* 5/2019 McLean ..... B65H 49/38  
2020/0397142 A1 \* 12/2020 Sampson ..... F16B 5/126

OTHER PUBLICATIONS

“iCube Full Fabric Drawer.” Found online Oct. 4, 2021 at [www.amazon.com](http://www.amazon.com). Product reviewed Apr. 3, 2015. Retrieved from URL: <https://tinyurl.com/3jeuaxnk> (Year: 2015).\*

“Drawer—Cabinet Boxes.” Found online Oct. 4, 2021 at [www.napcousa.com](http://www.napcousa.com). Page archived Oct. 1, 2020. Retrieved from URL: <https://web.archive.org/web/20201001011308/https://napcousa.com/project/drawer-boxes/> (Year: 2020).\*

“An Ode to Ikea Kallax Shelves, The Best Vinyl Record Storage.” Found online Oct. 4, 2021 at [www.magazin.vinylmeplease.com](http://www.magazin.vinylmeplease.com). Page dated Nov. 15, 2016. Retrieved from URL: <https://magazine.vinylmeplease.com/magazine/an-ode-to-ikea-kallax-shelves-the-best-record-storage/> (Year: 2016).\*

\* cited by examiner

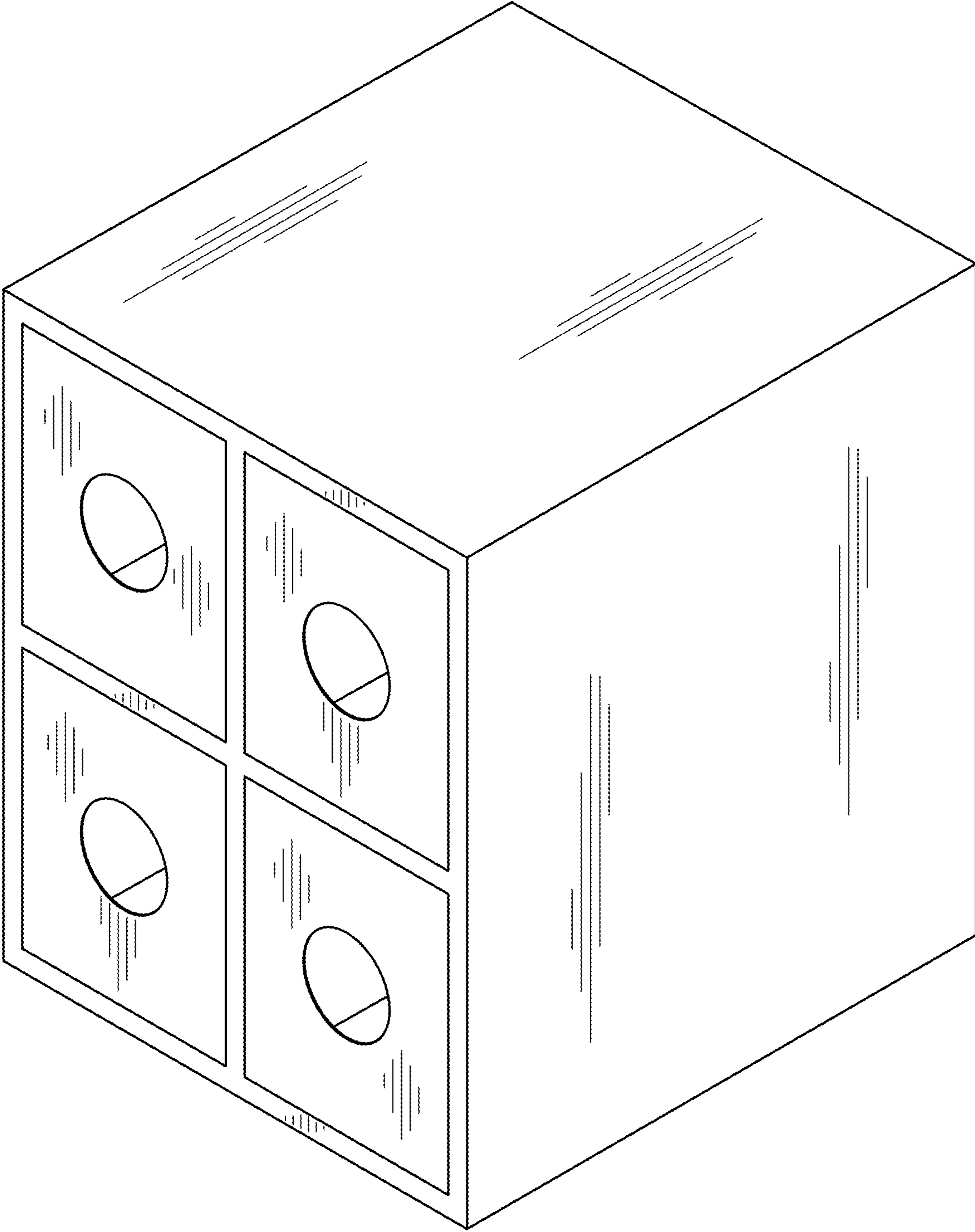

Fig. 1

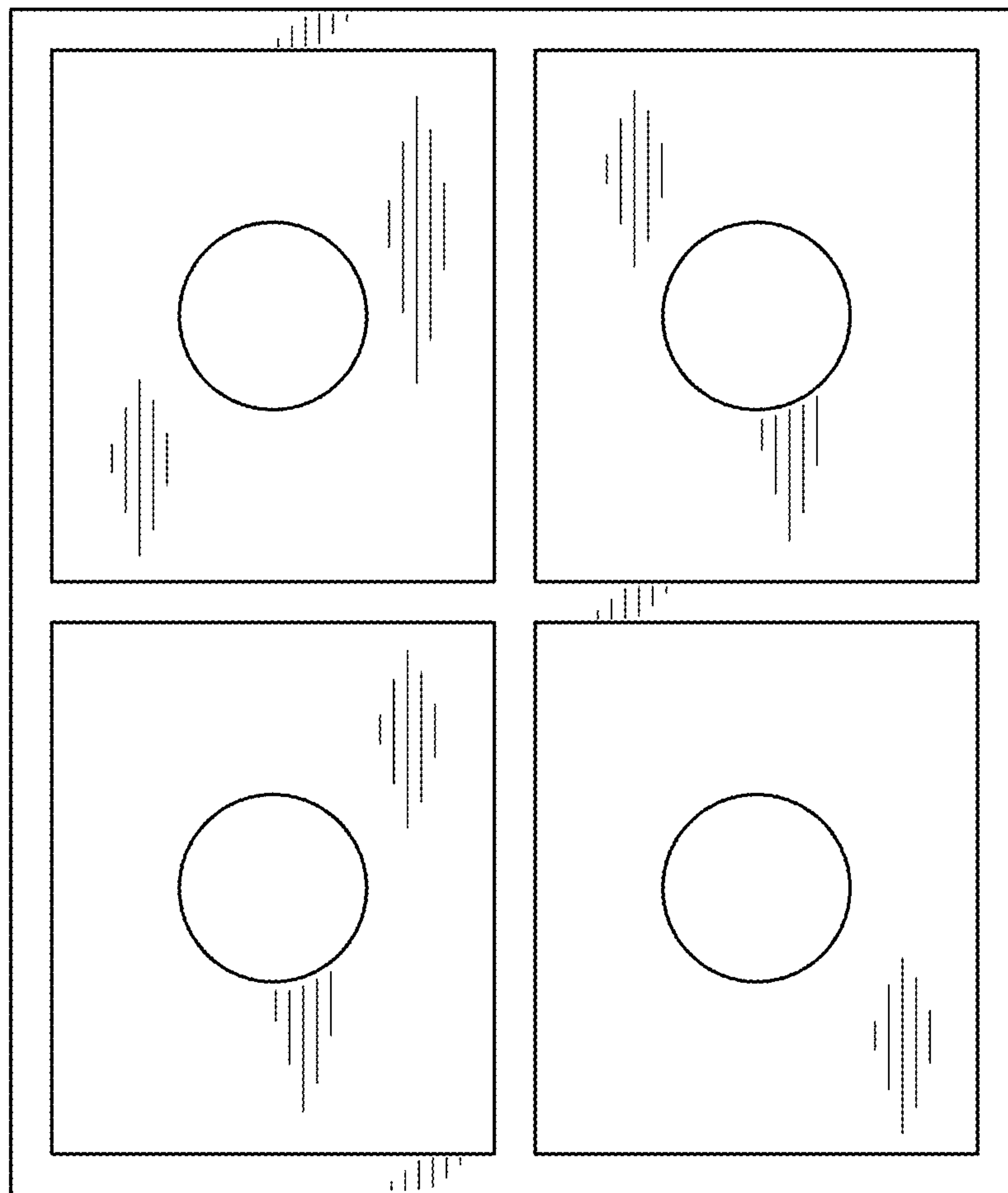

Fig. 2



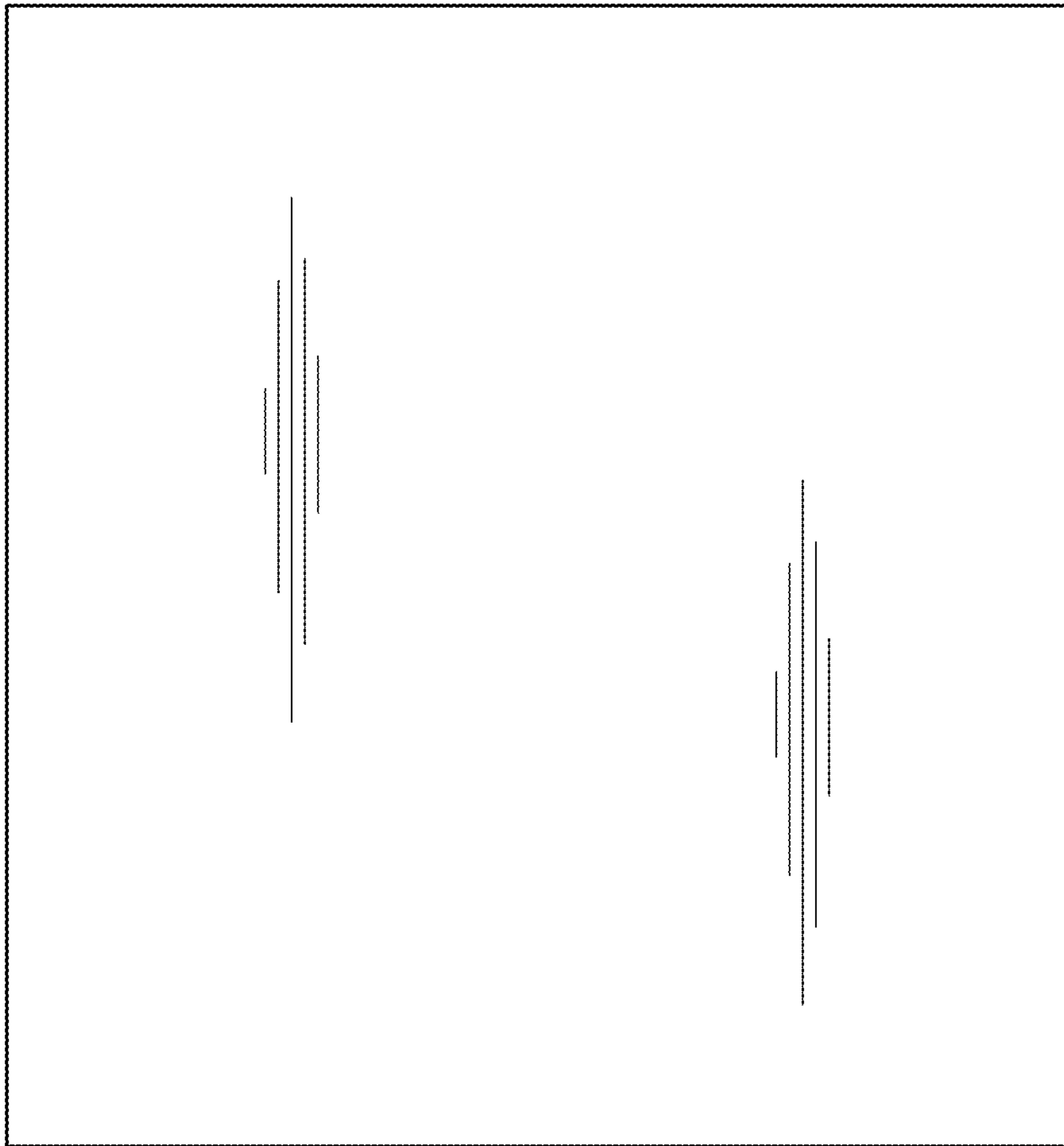

Fig. 3

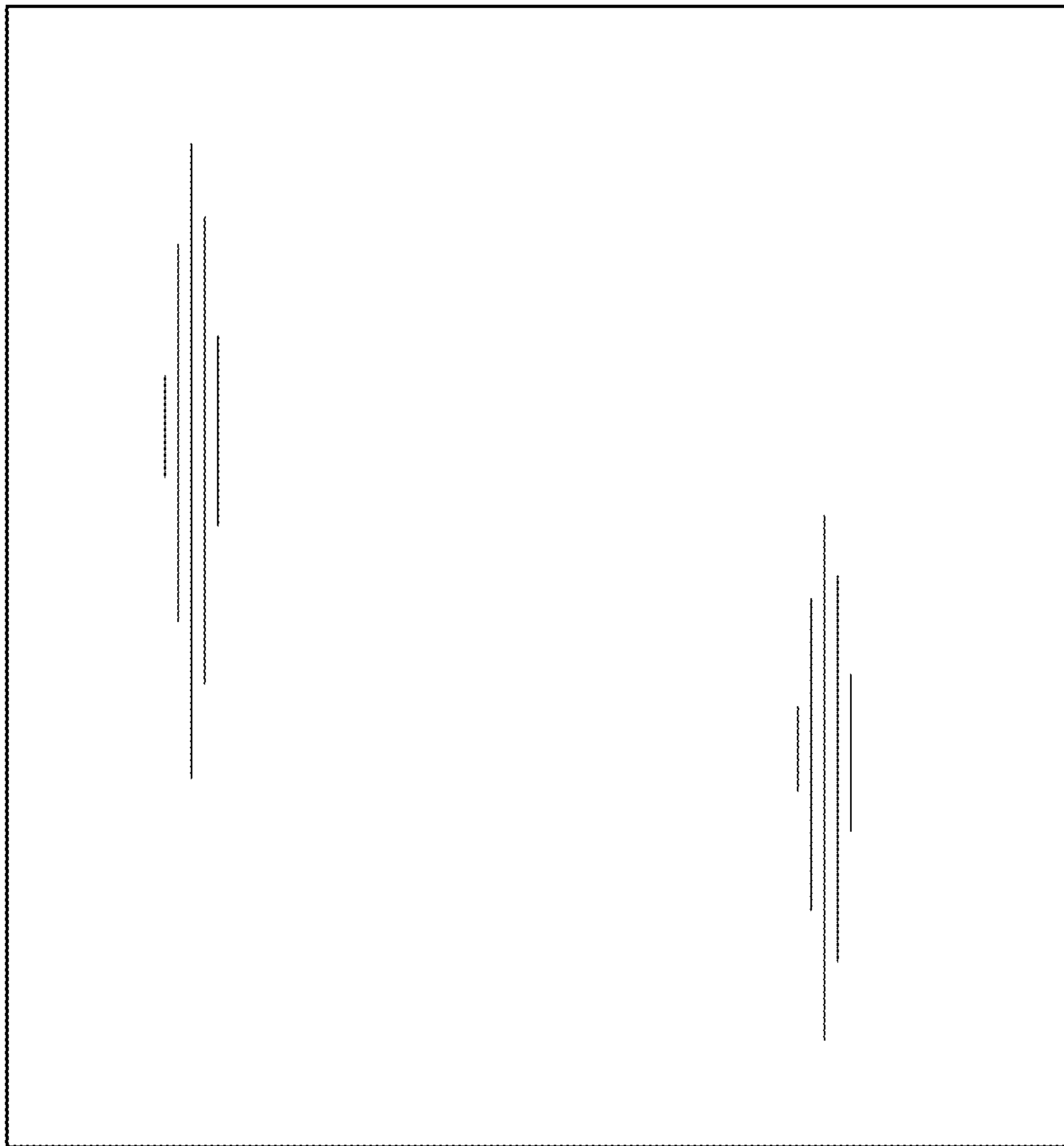

Fig. 4

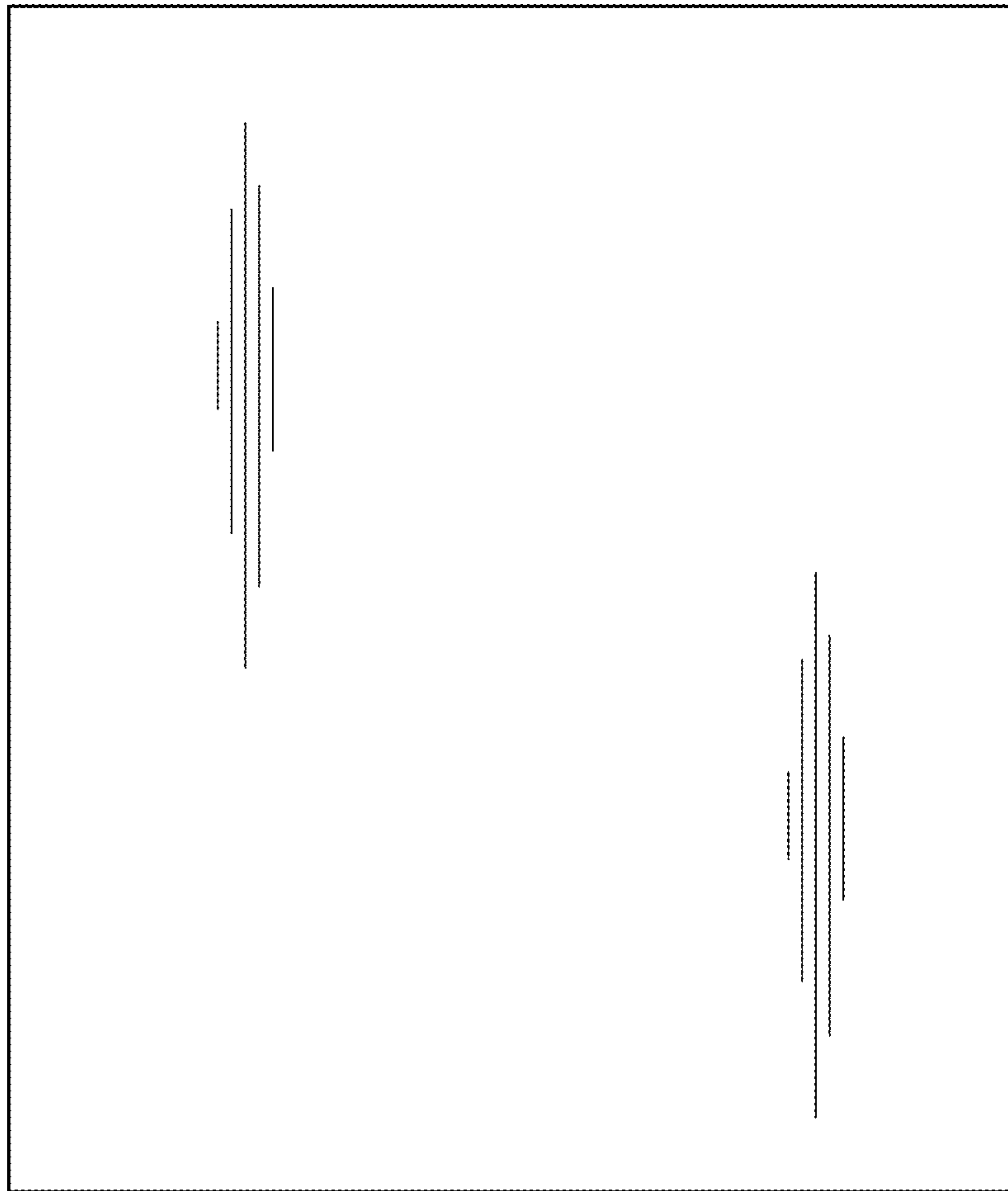

Fig. 5

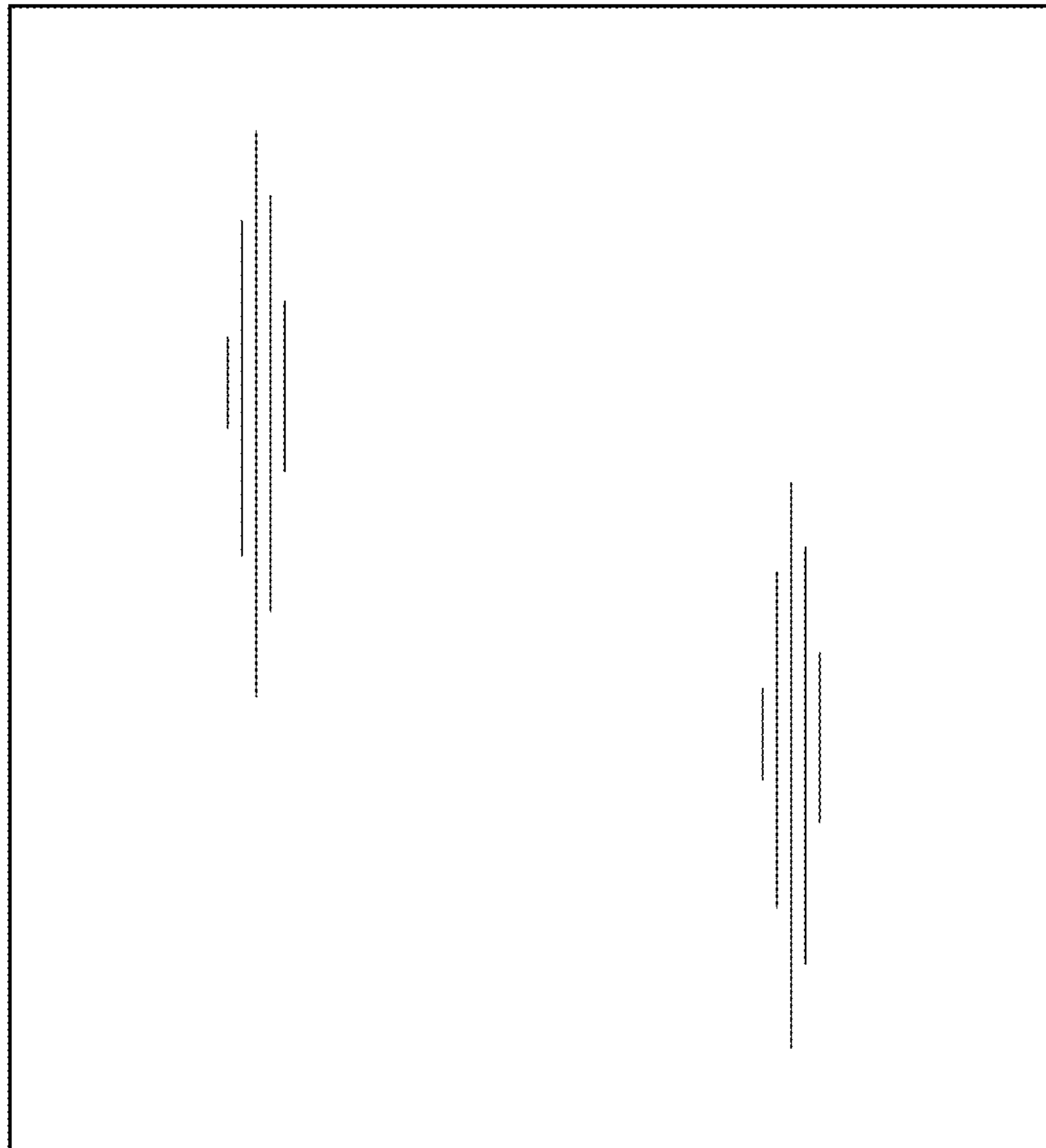

Fig. 6



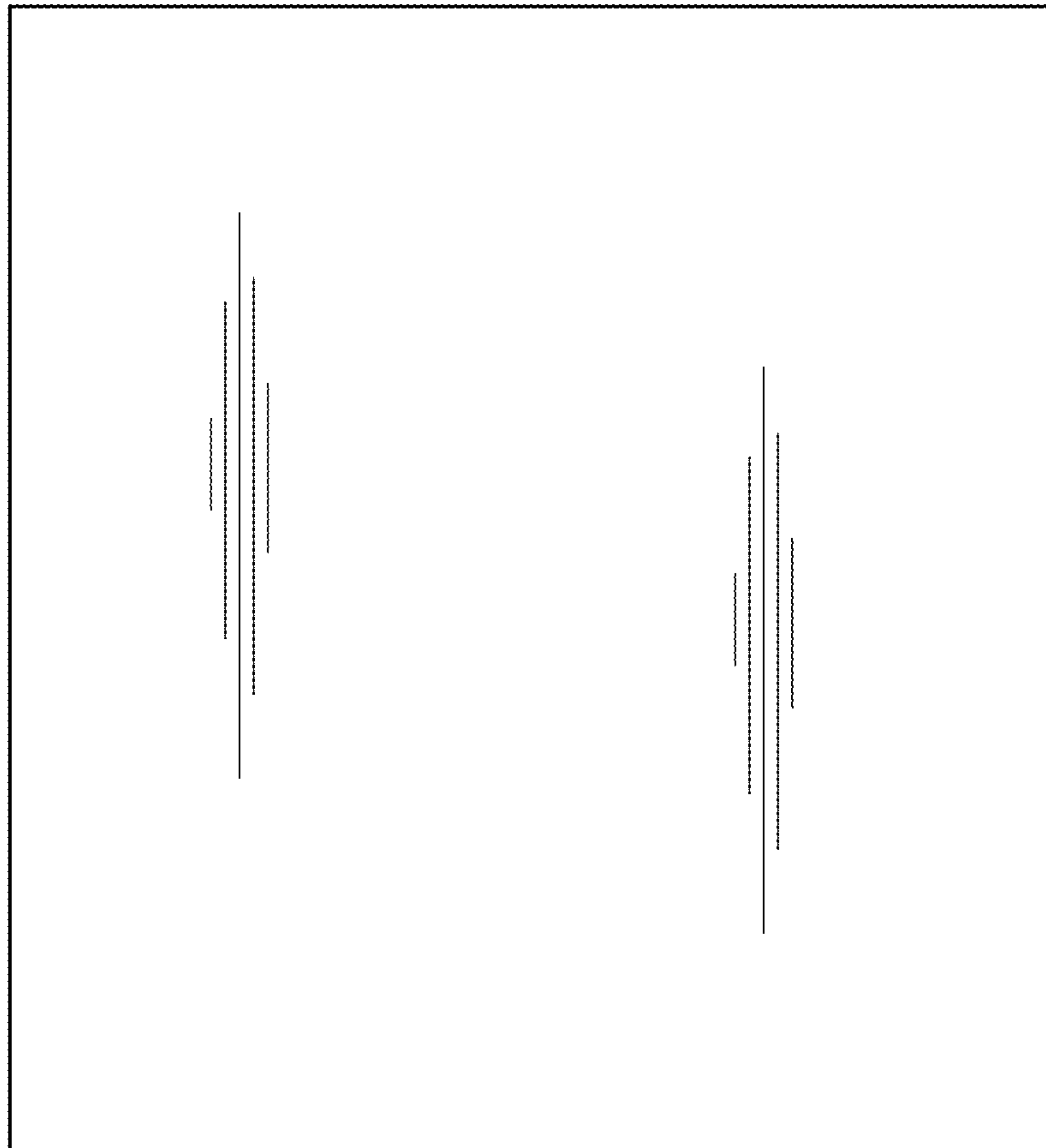

Fig. 7

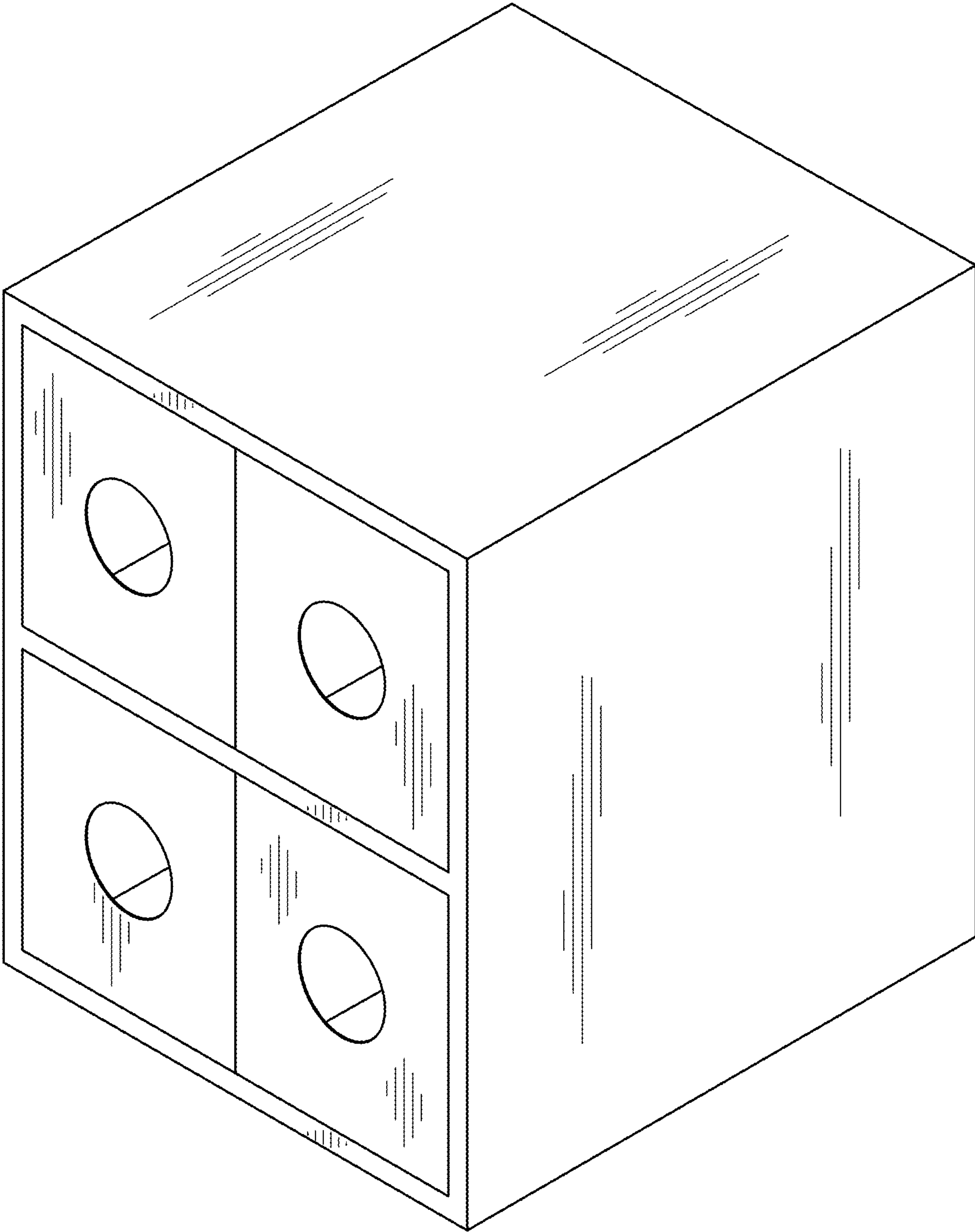

Fig. 8

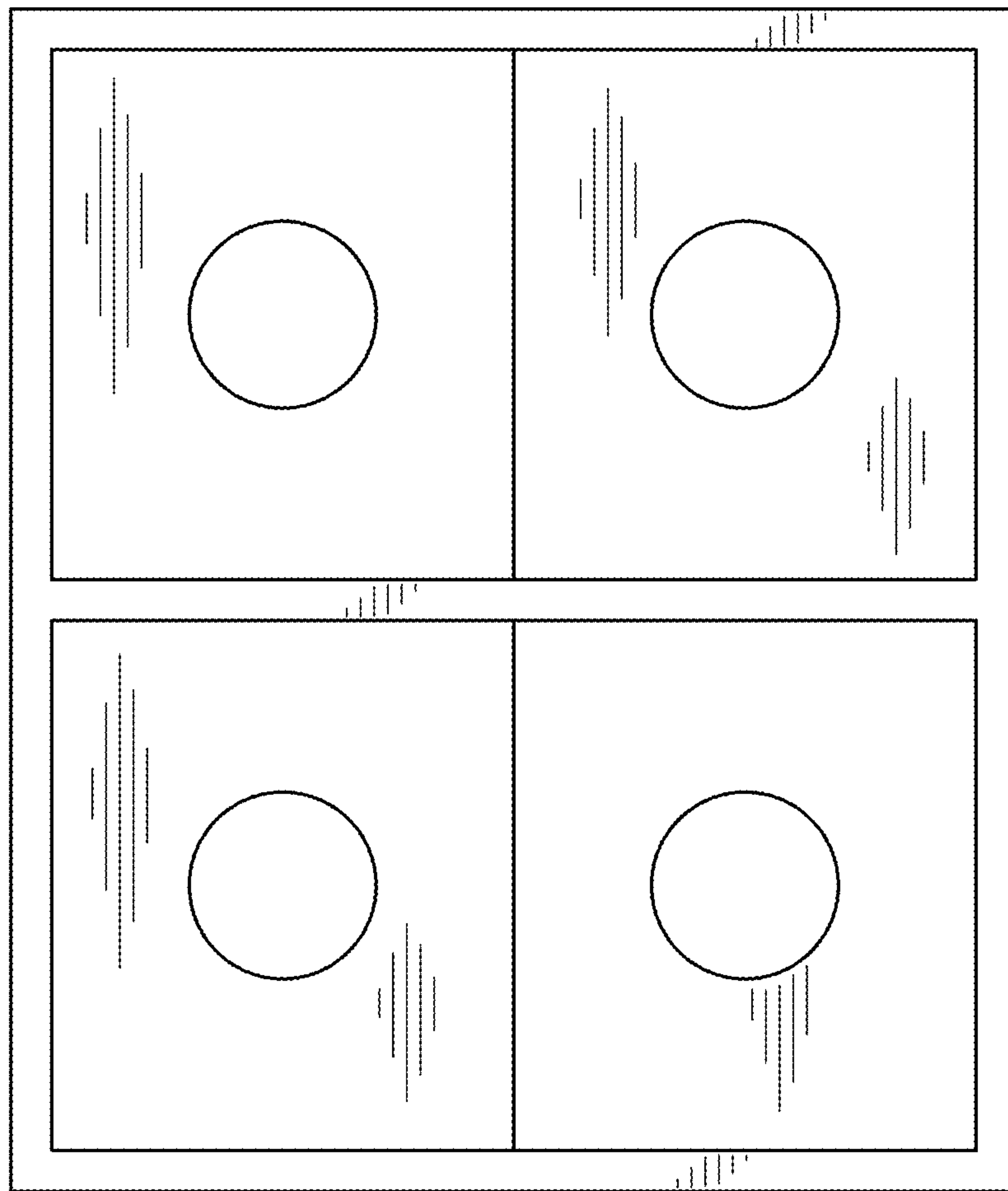

Fig. 9

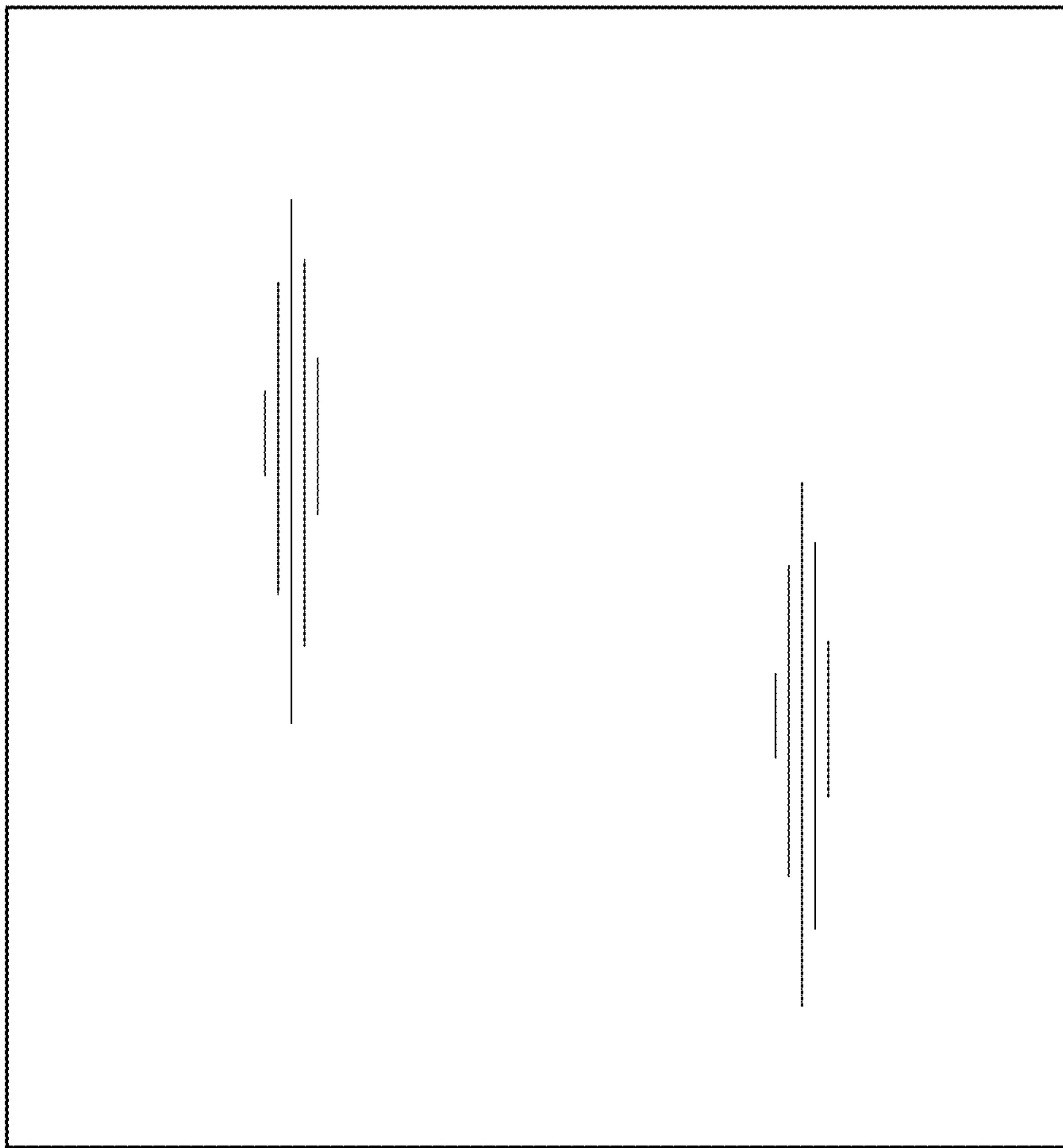

Fig. 10

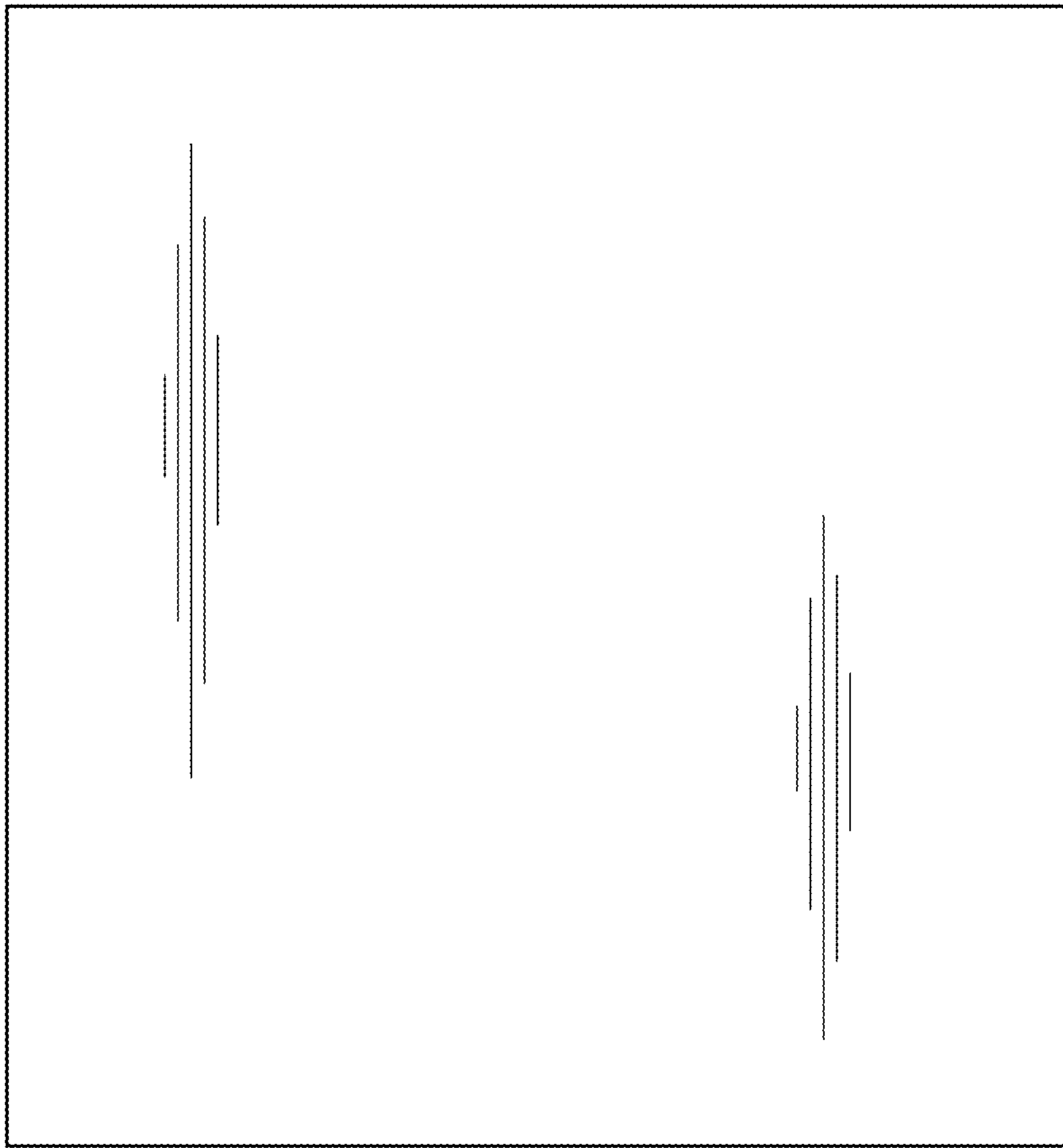

Fig. 11

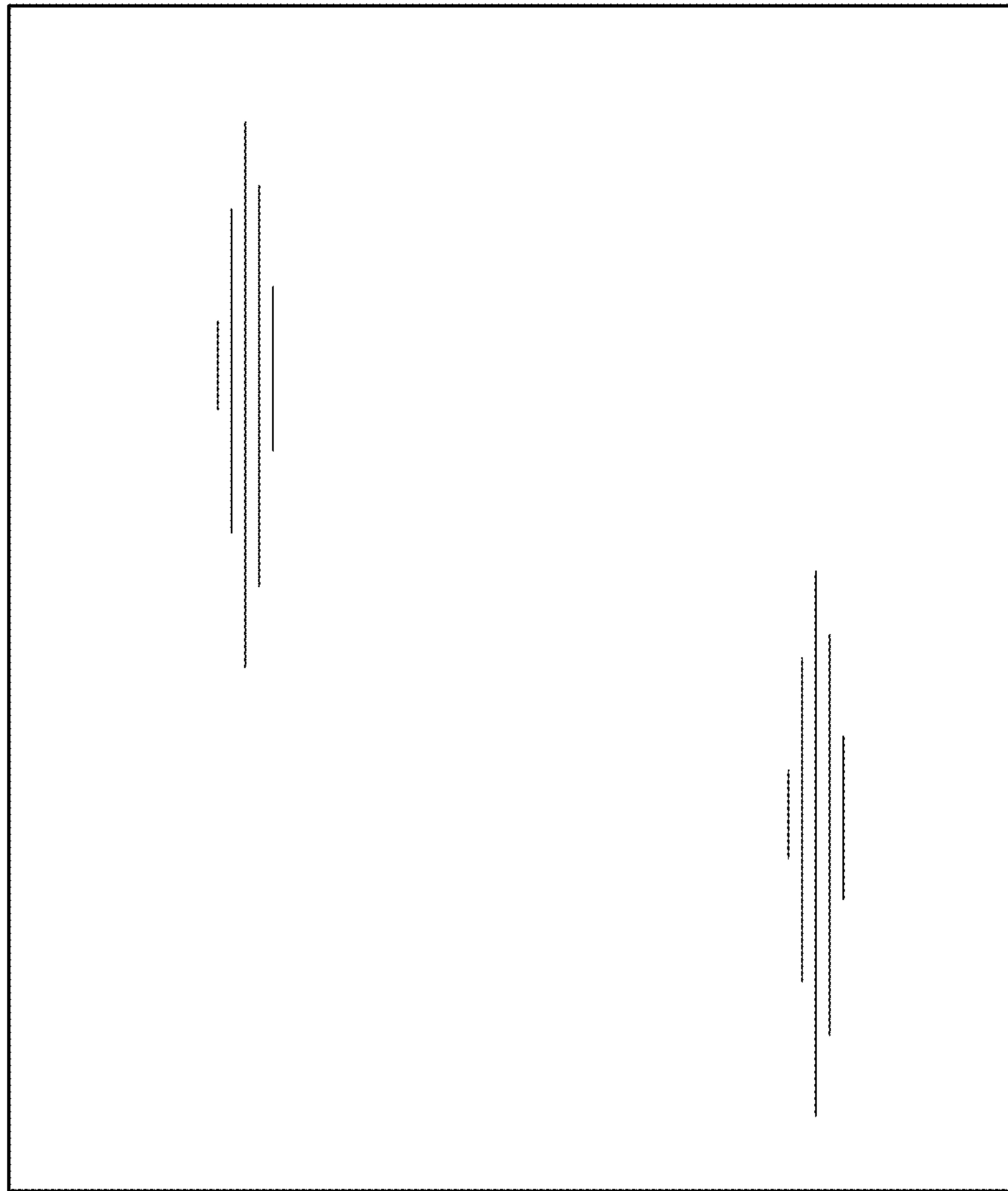

Fig. 12



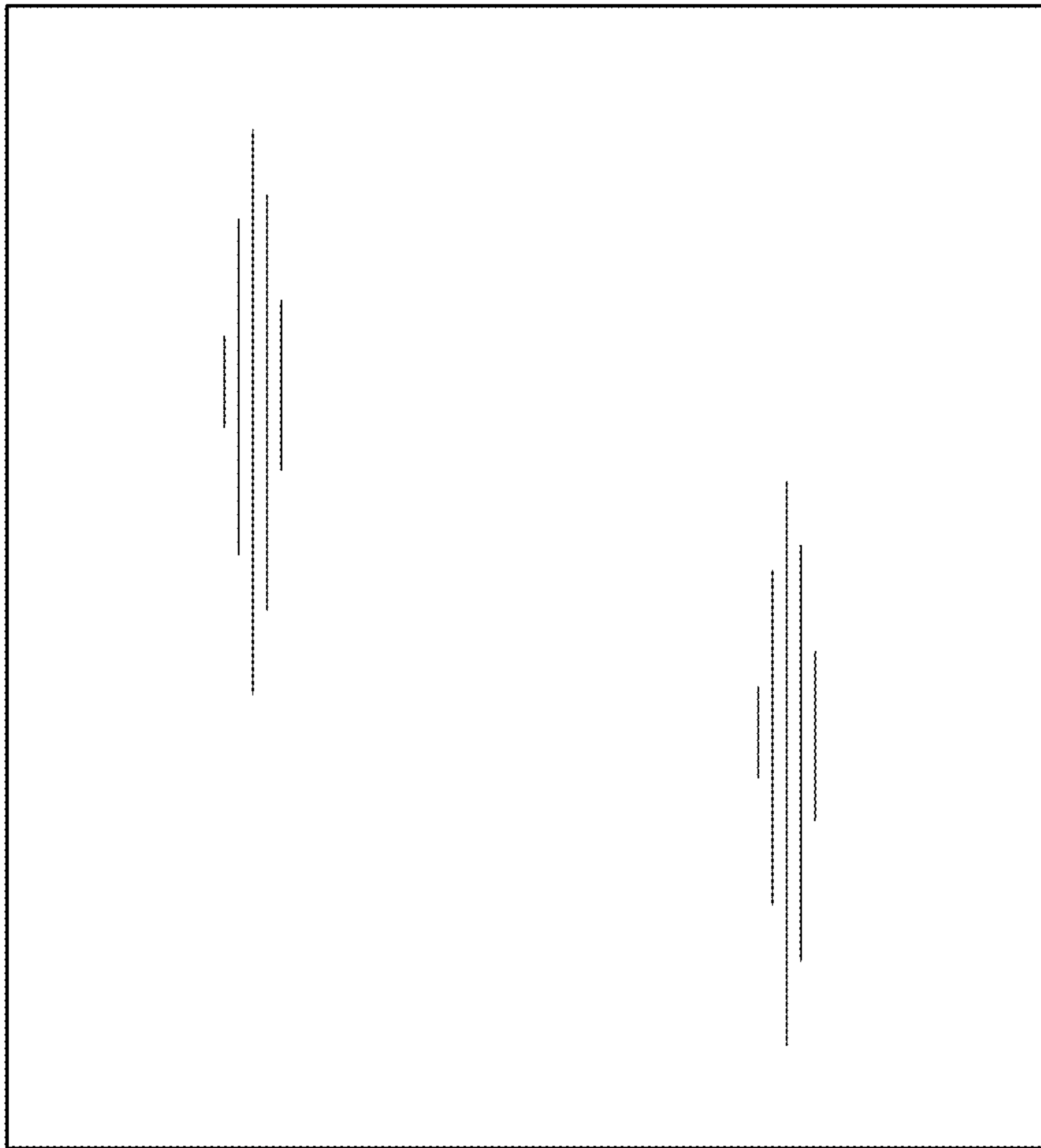

Fig. 13

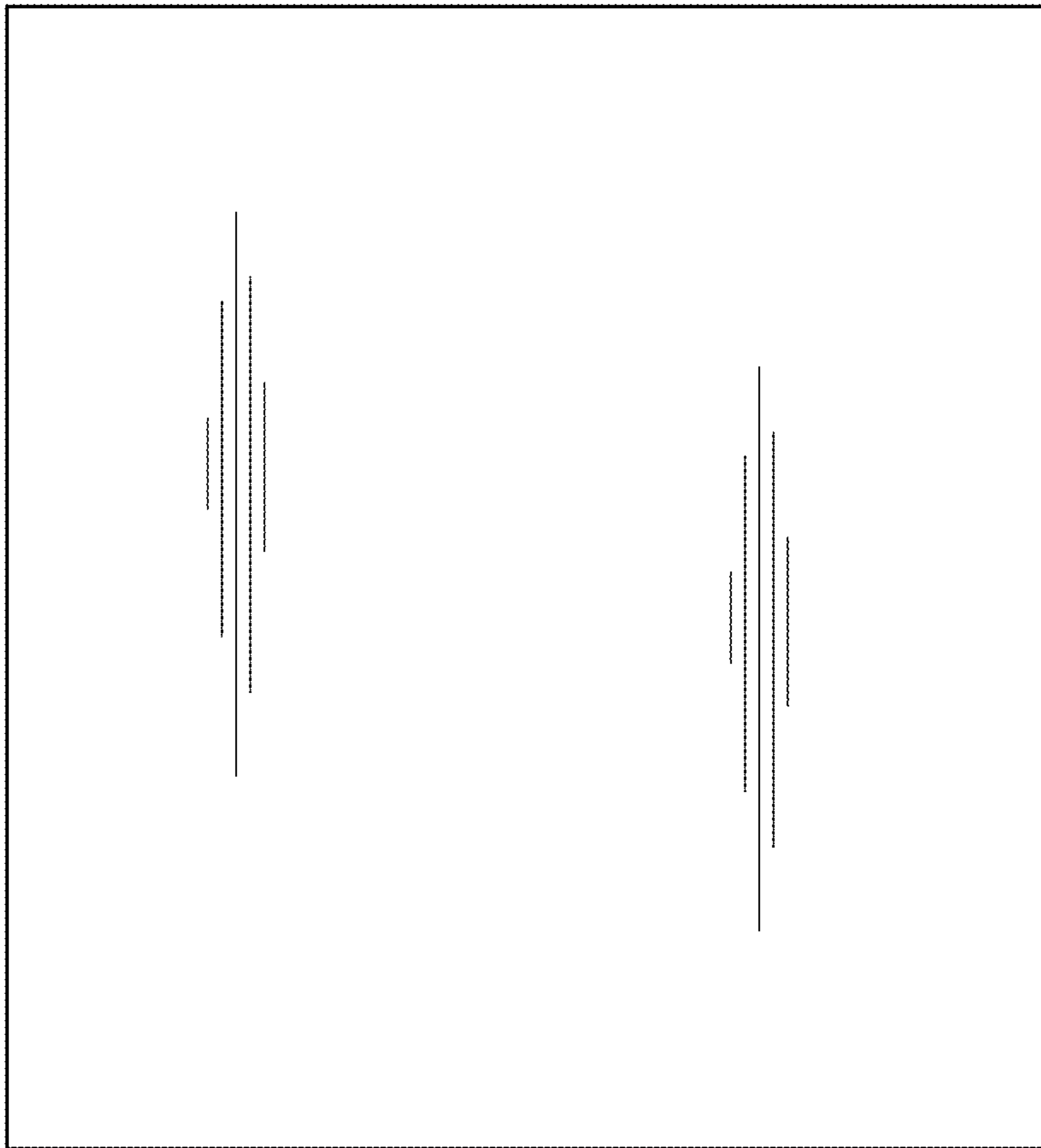

Fig. 14

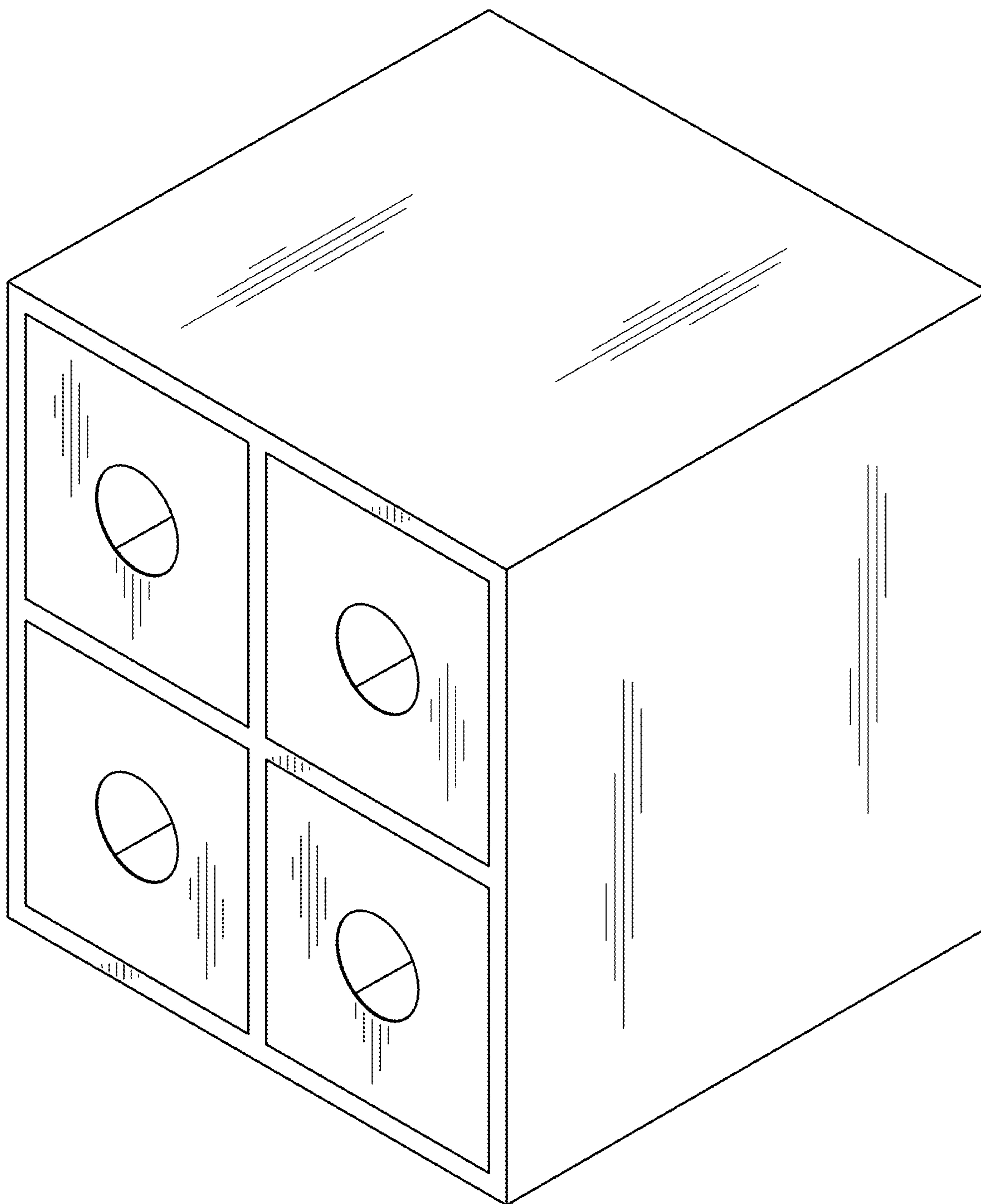

Fig. 15

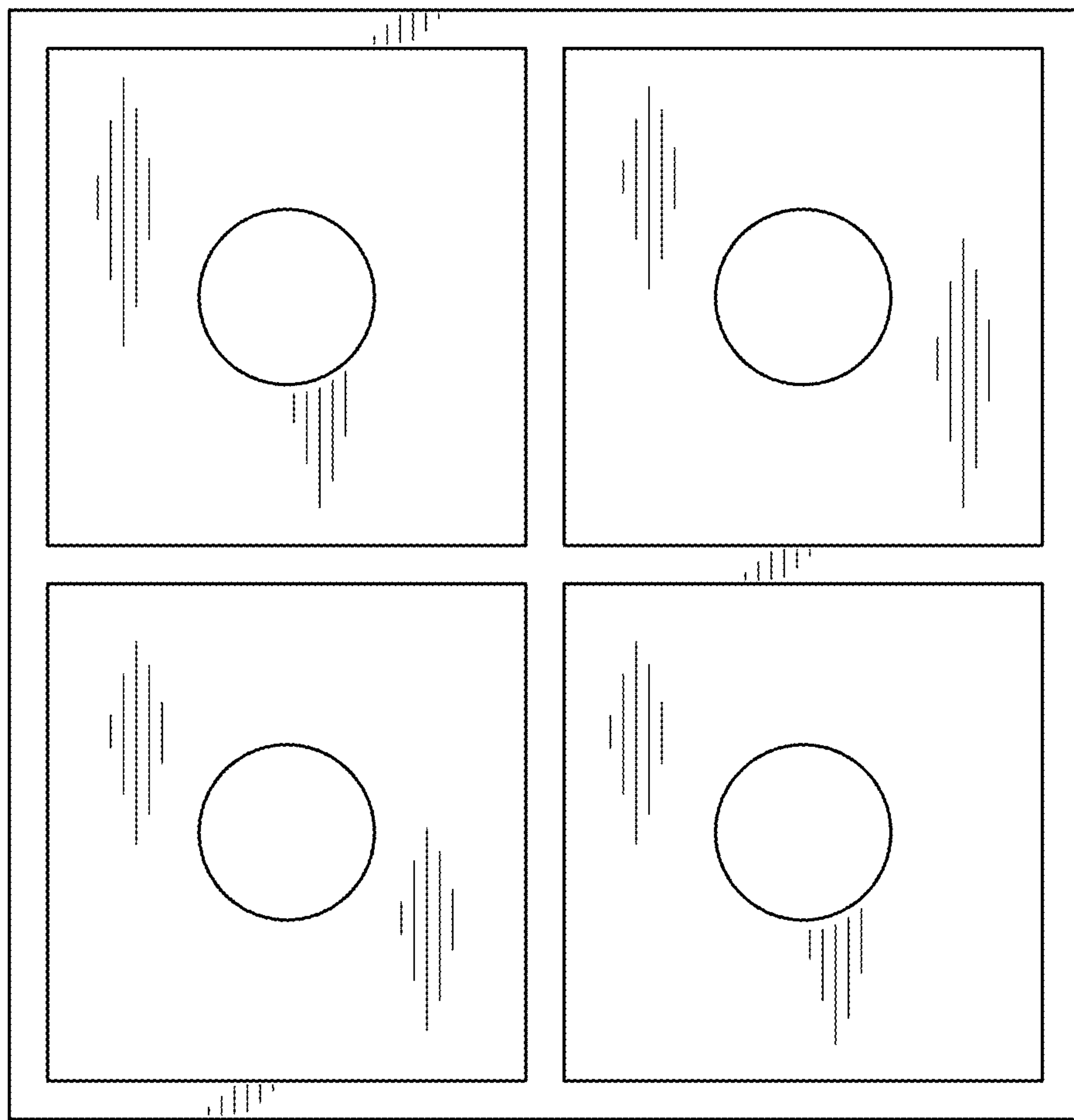

Fig. 16

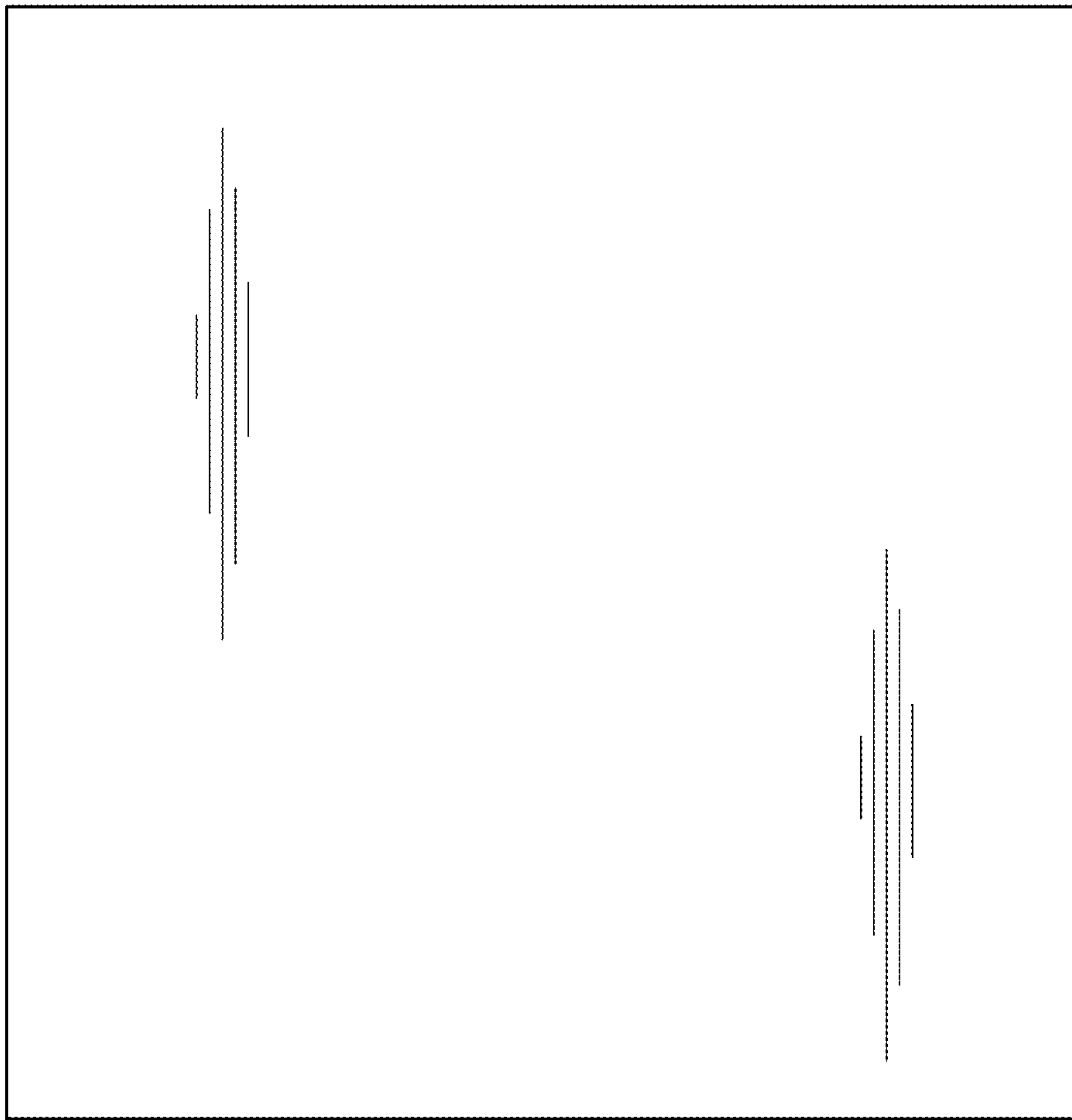

Fig. 17

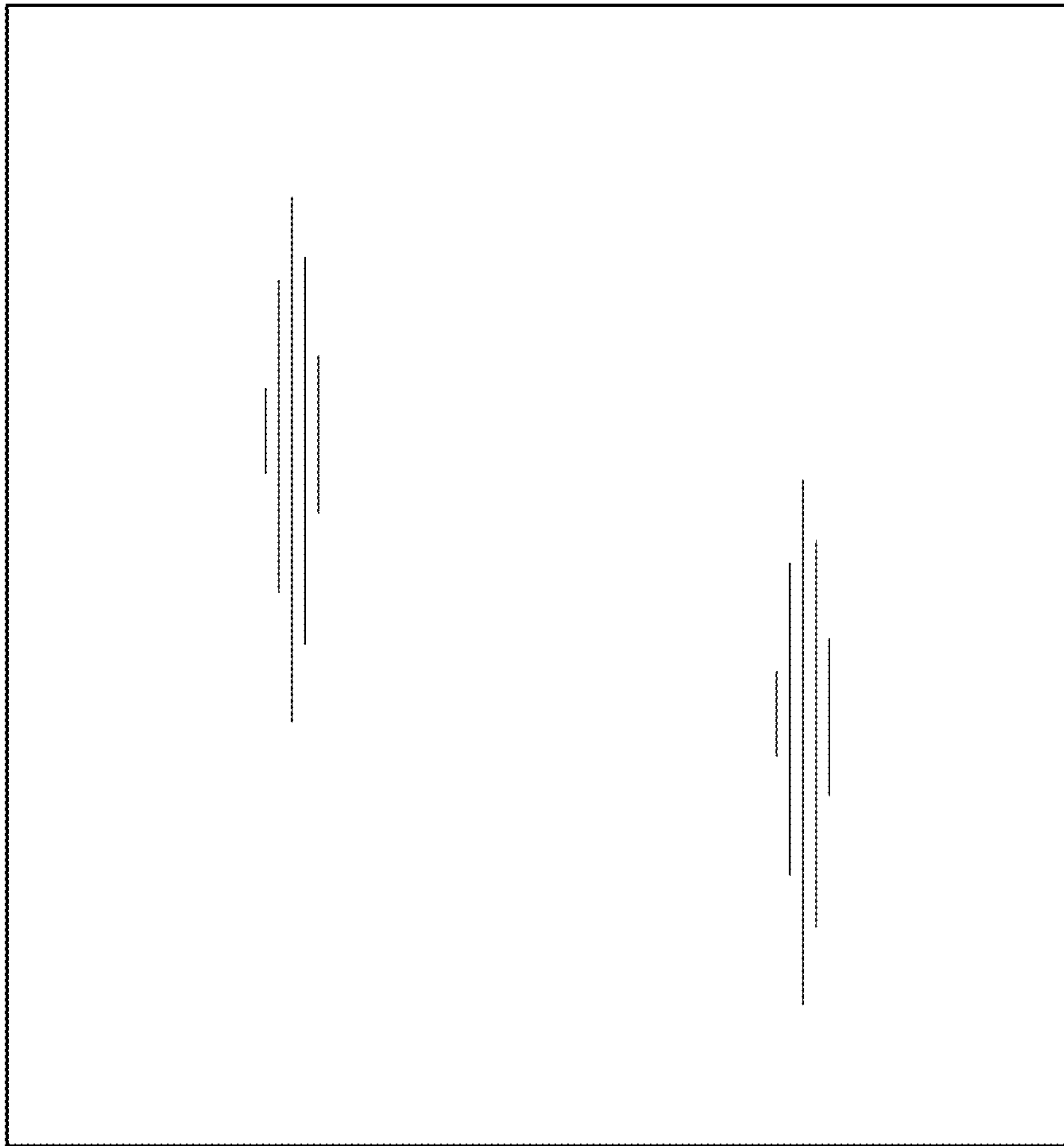

Fig. 18



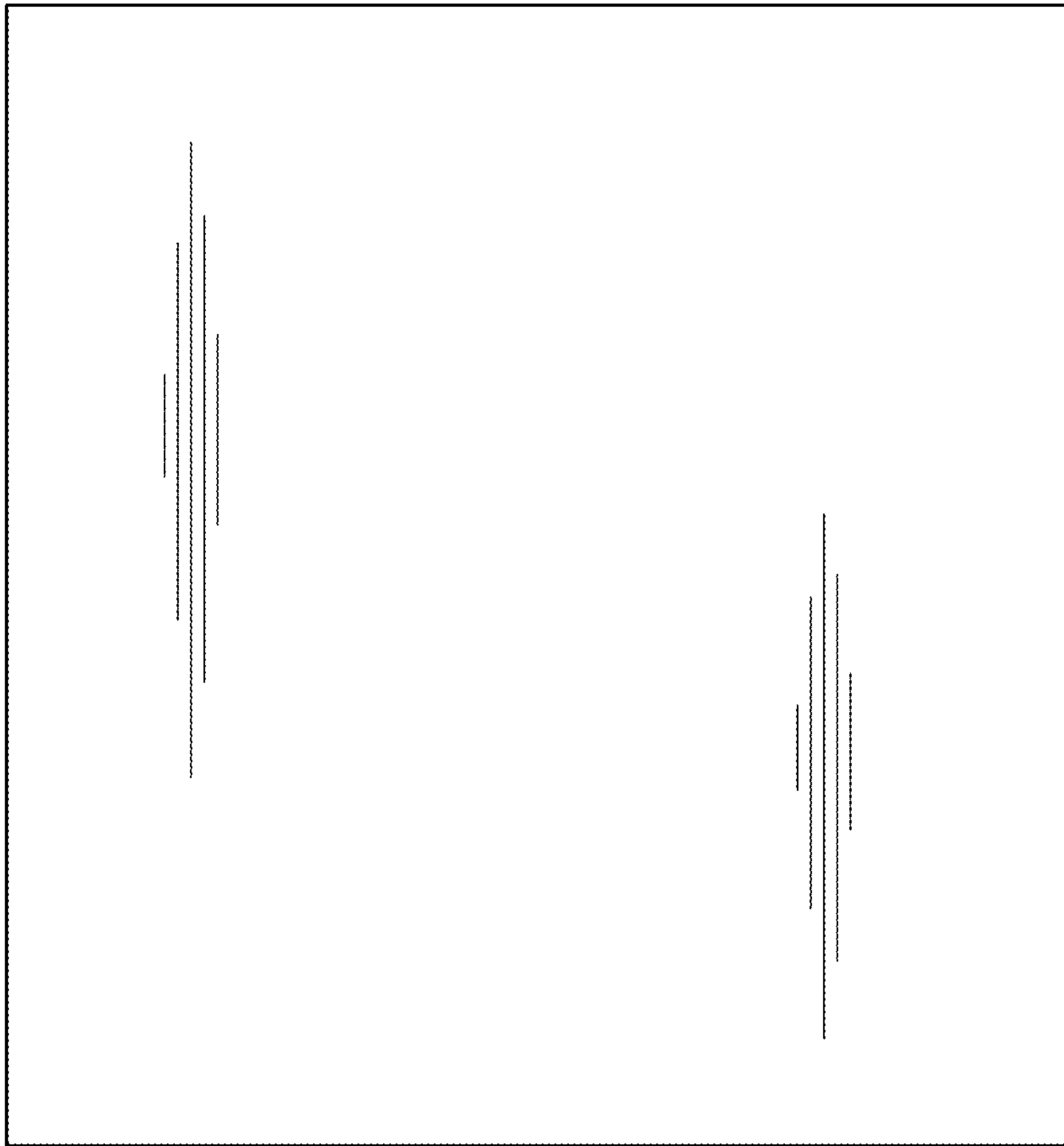

Fig. 19

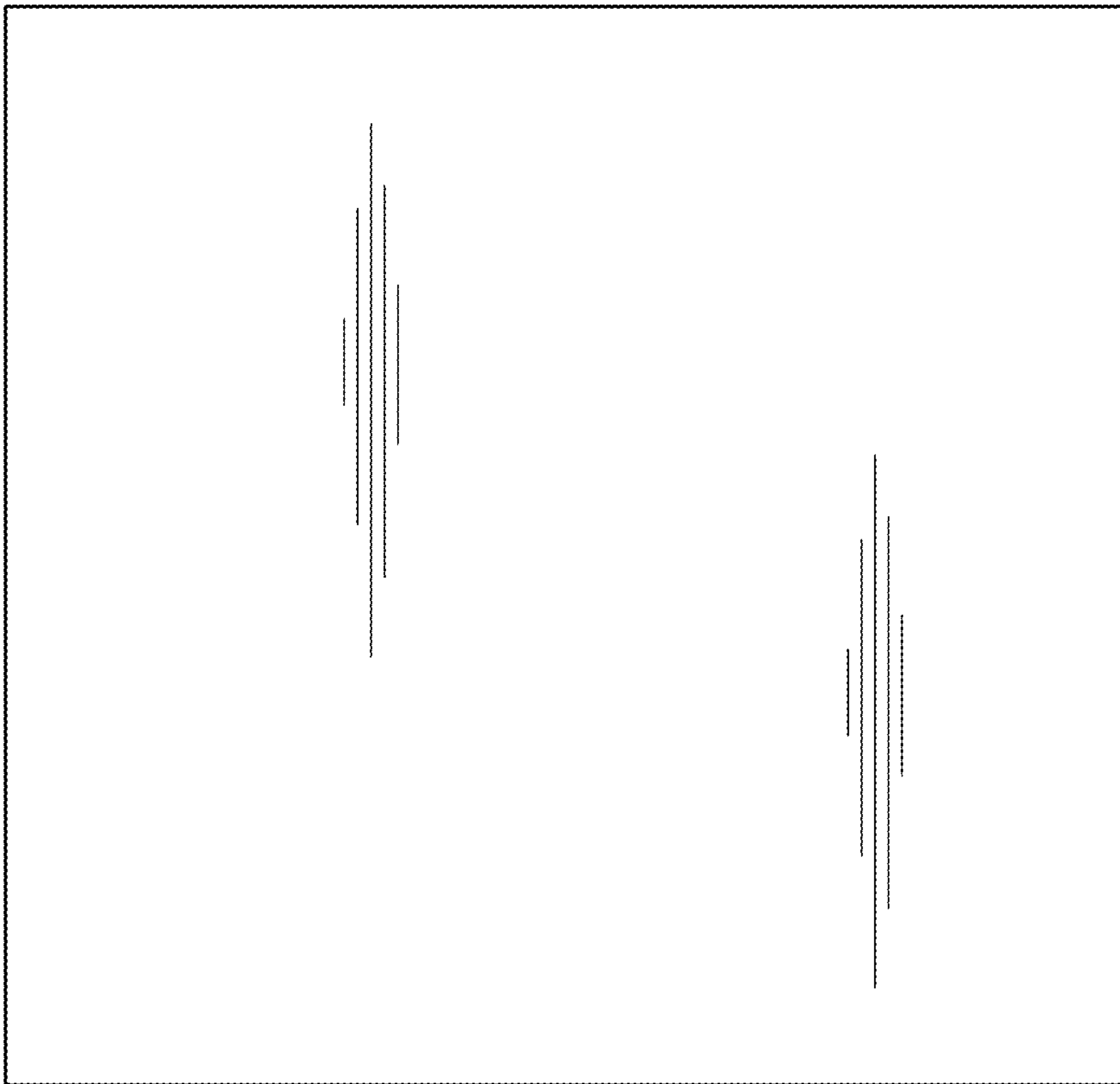

Fig. 20

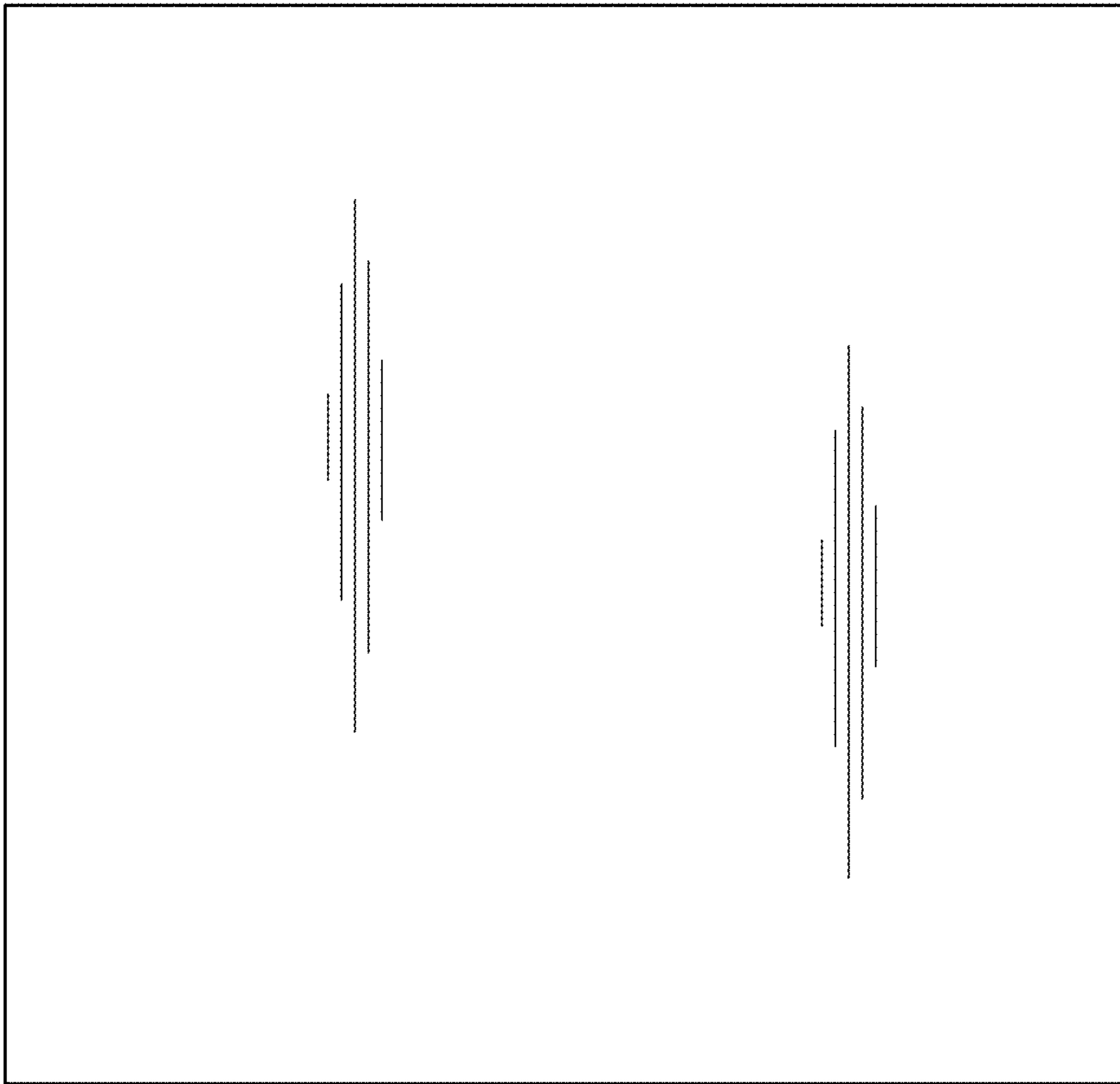

Fig. 21