



US00D950260S

(12) **United States Design Patent** (10) **Patent No.:** **US D950,260 S**  
**Zhang** (45) **Date of Patent:** **\*\* May 3, 2022**

(54) **MESH CHAIR**

(71) Applicant: **Anji Longbo Furniture co., Ltd,**  
Huzhou (CN)

(72) Inventor: **Zhongping Zhang,** Huzhou (CN)

(73) Assignee: **ANJI LONGBO FURNITURE CO., LTD,** Huzhou (CN)

(\*\*) Term: **15 Years**

(21) Appl. No.: **29/754,569**

(22) Filed: **Oct. 13, 2020**

(30) **Foreign Application Priority Data**

Sep. 9, 2020 (CN) ..... 202030532048.3

(51) **LOC (13) Cl.** ..... **06-01**

(52) **U.S. Cl.**  
USPC ..... **D6/366**

(58) **Field of Classification Search**

USPC ..... D6/356, 364, 365, 366, 367, 379, 716,  
D6/716.4, 716.7, 360, 380; D21/521, 695  
CPC ..... A47C 1/03294; A47C 1/034; A47C 1/032;  
A47C 1/031; A47C 1/023; A47C 3/029;  
A47C 3/027; A47C 3/04; A47C 3/02;  
A47C 3/12; A47C 4/03; A47C 4/04;  
A47C 5/12; A47C 7/029; A47C 7/02;  
A47C 7/18; A47C 7/28; A47C 7/32;  
A47C 7/38; A47C 7/40; A47C 7/44;  
A47C 7/46; A47C 7/54; A47C 7/425;  
A47C 7/445; A47C 31/023; A47C 31/04;  
B60R 2/0284; B60R 2/062; B60R 22/001;  
B60R 22/24; B60R 22/28; B60R 22/58;  
B60R 22/64; B60R 22/68; B60R 22/80;  
B60R 22/99; B60R 22/245; B60R 22/643;  
B60R 22/646; B60R 22/665; B60R  
22/686; B60R 22/688; B60R 22/803;  
B60R 22/986; B60R 22/914; B60R  
22/995; F16B 2/08; F16B 45/00; Y10S  
297/01; A47D 13/10

See application file for complete search history.

(56) **References Cited**

U.S. PATENT DOCUMENTS

D494,768	S	*	8/2004	Su	.....	D6/366
6,974,189	B2	*	12/2005	Machael	.....	A47C 1/03 297/411.36
D563,686	S	*	3/2008	Raftyery	.....	D6/366
D563,687	S	*	3/2008	Neil	.....	D6/366
D566,410	S	*	4/2008	Neil	.....	D6/366
D640,477	S	*	6/2011	Neil	.....	D6/366
D673,384	S	*	1/2013	Yang	.....	D6/366
D900,496	S	*	11/2020	Shen	.....	D6/366
D924,594	S	*	7/2021	Zhong	.....	D6/366
2002/0190564	A1	*	12/2002	Coffield	.....	A47C 7/40 297/452.56

\* cited by examiner

*Primary Examiner* — Kevin K Rudzinski

*Assistant Examiner* — Paul D Bohannon

(74) *Attorney, Agent, or Firm* — Bayramoglu Law Offices LLC

(57) **CLAIM**

The ornamental design for a mesh chair, as shown and described.

**DESCRIPTION**

FIG. 1 is a perspective view of a mesh chair showing my new design;  
FIG. 2 is a front view thereof;  
FIG. 3 is a rear view thereof;  
FIG. 4 is a left side view thereof;  
FIG. 5 is a right side view thereof;  
FIG. 6 is a top view thereof; and,  
FIG. 7 is a bottom view thereof.  
The broken lines shown in the drawings are for the purpose of illustrating portions of the mesh chair that form no part of the claimed design.

**1 Claim, 7 Drawing Sheets**

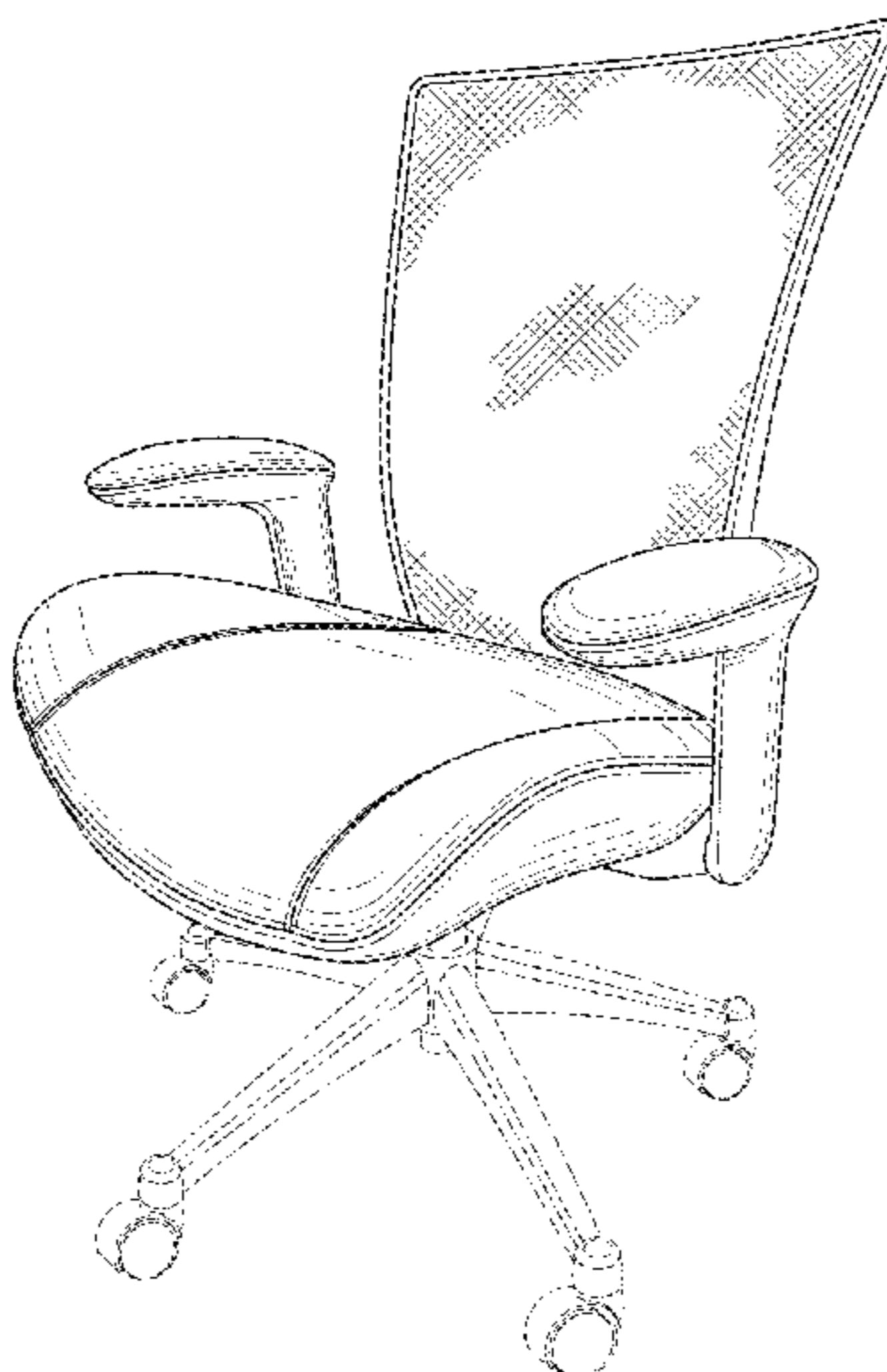

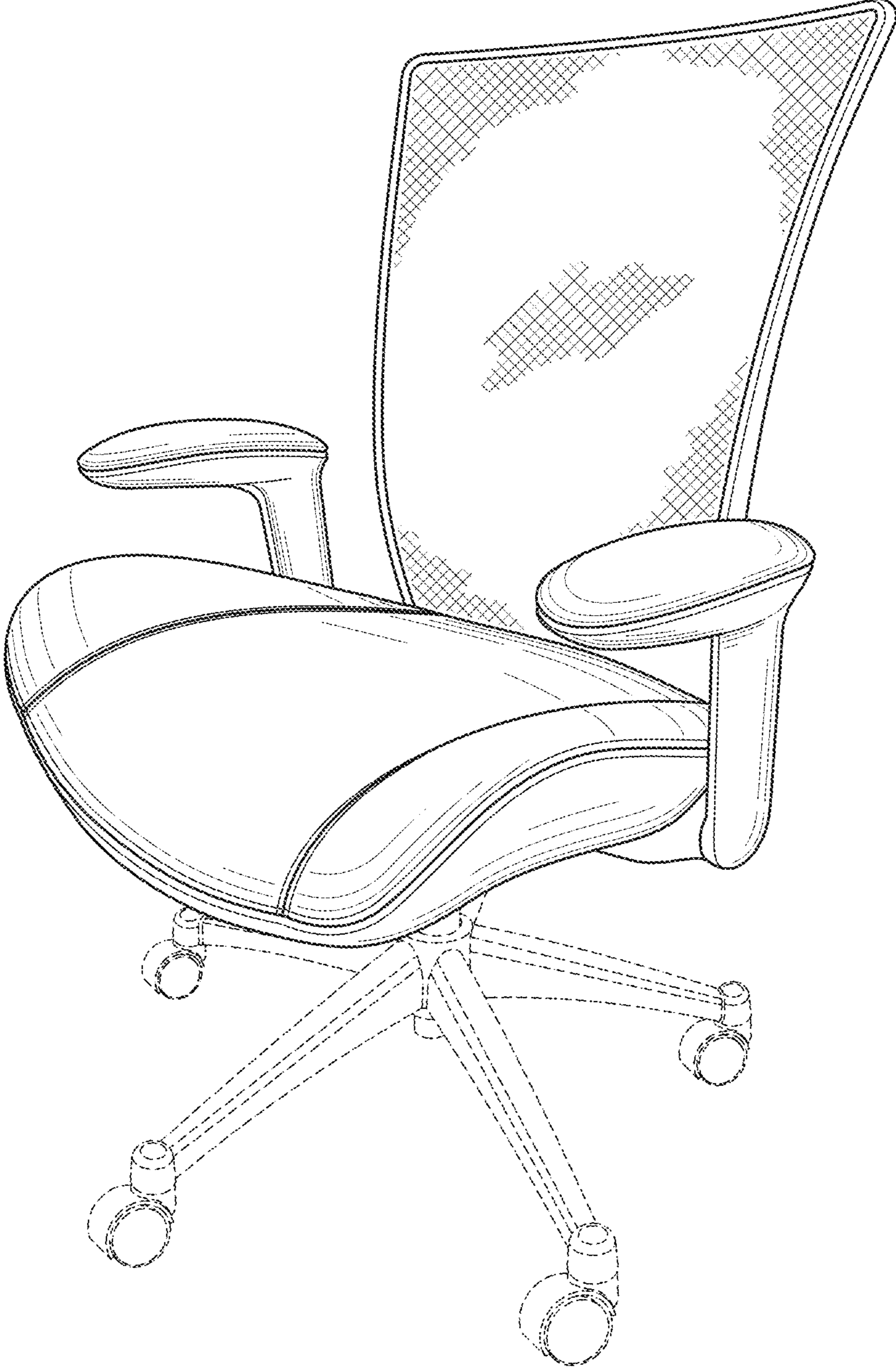

FIG. 1

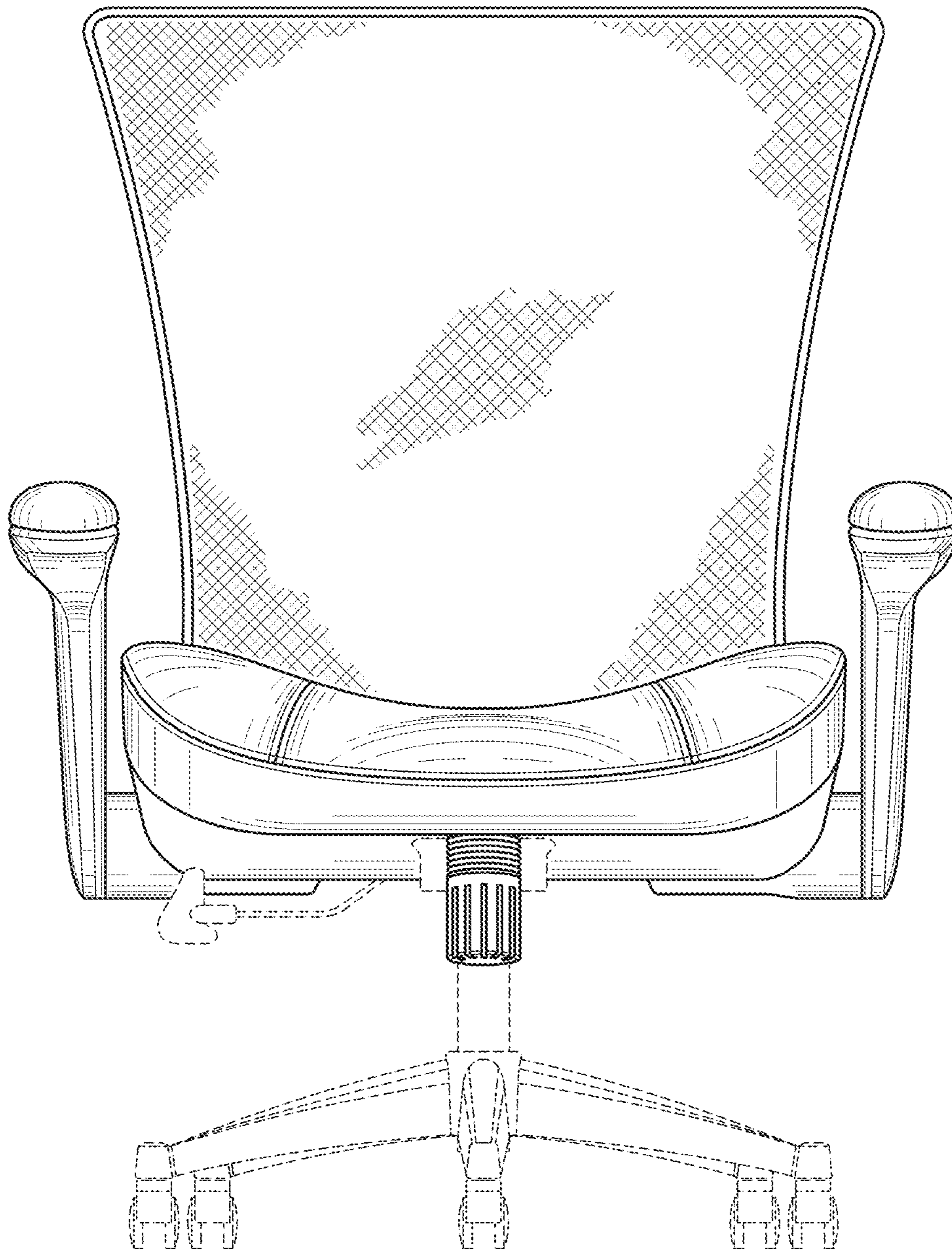

FIG. 2

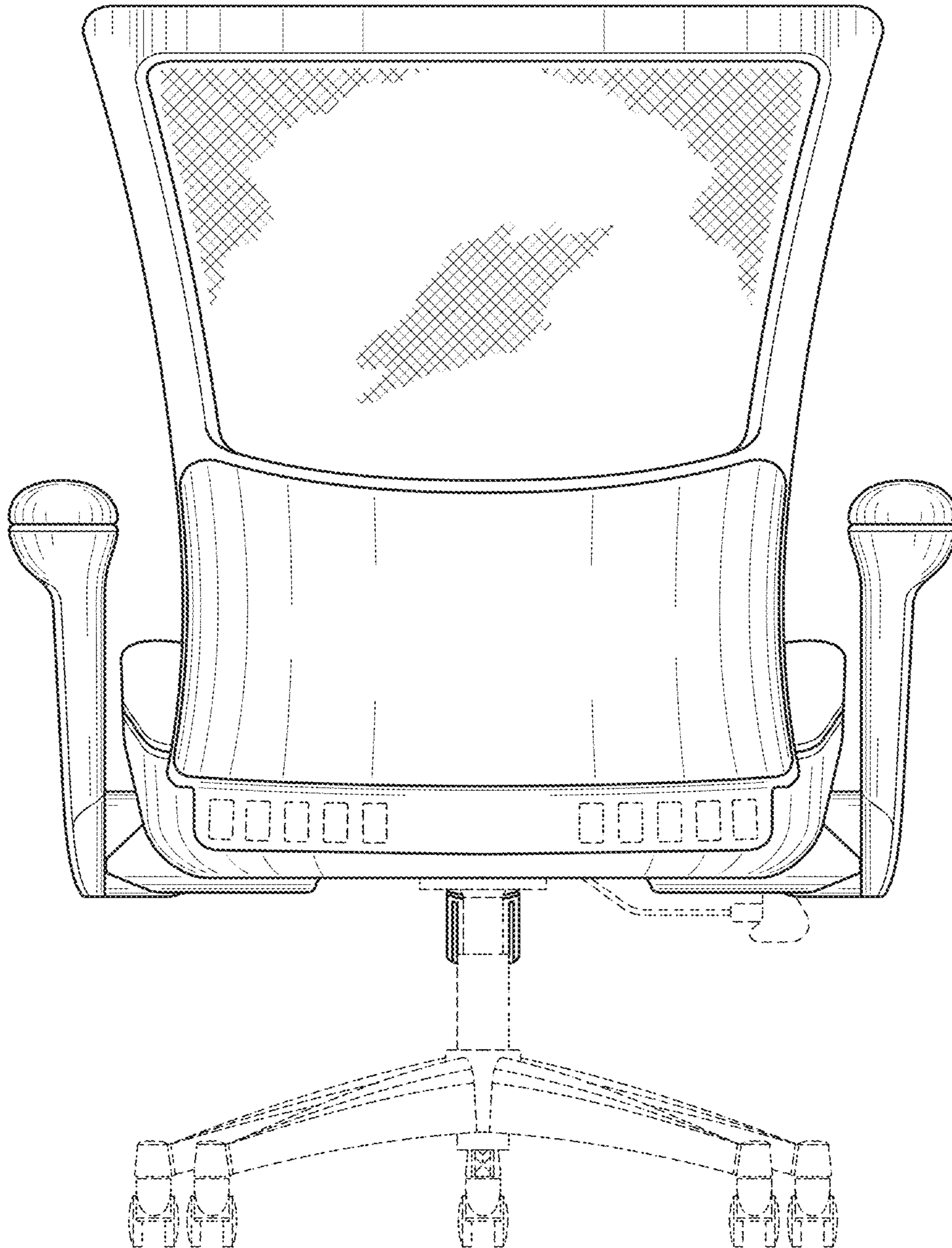

FIG. 3

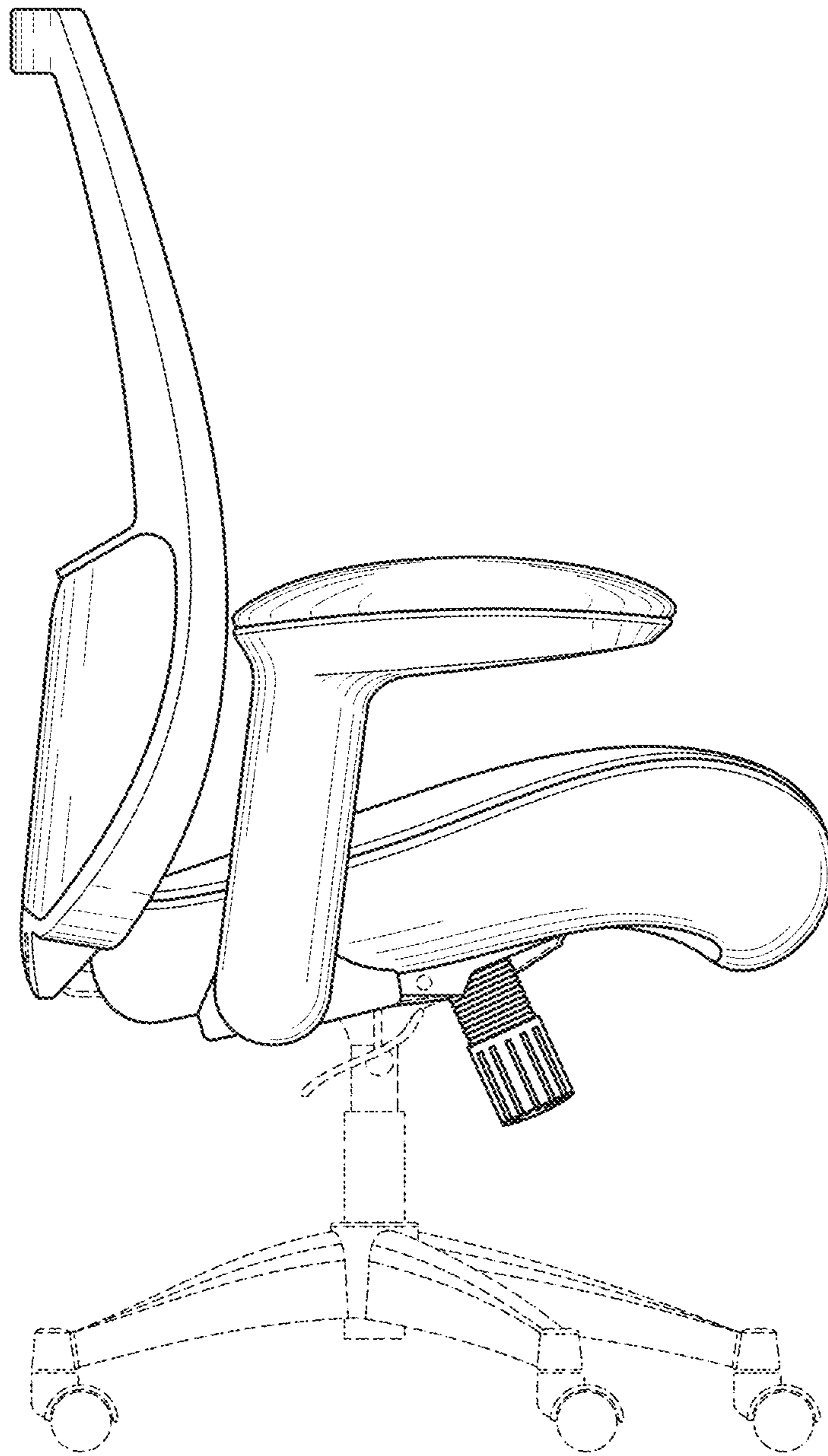

FIG. 4

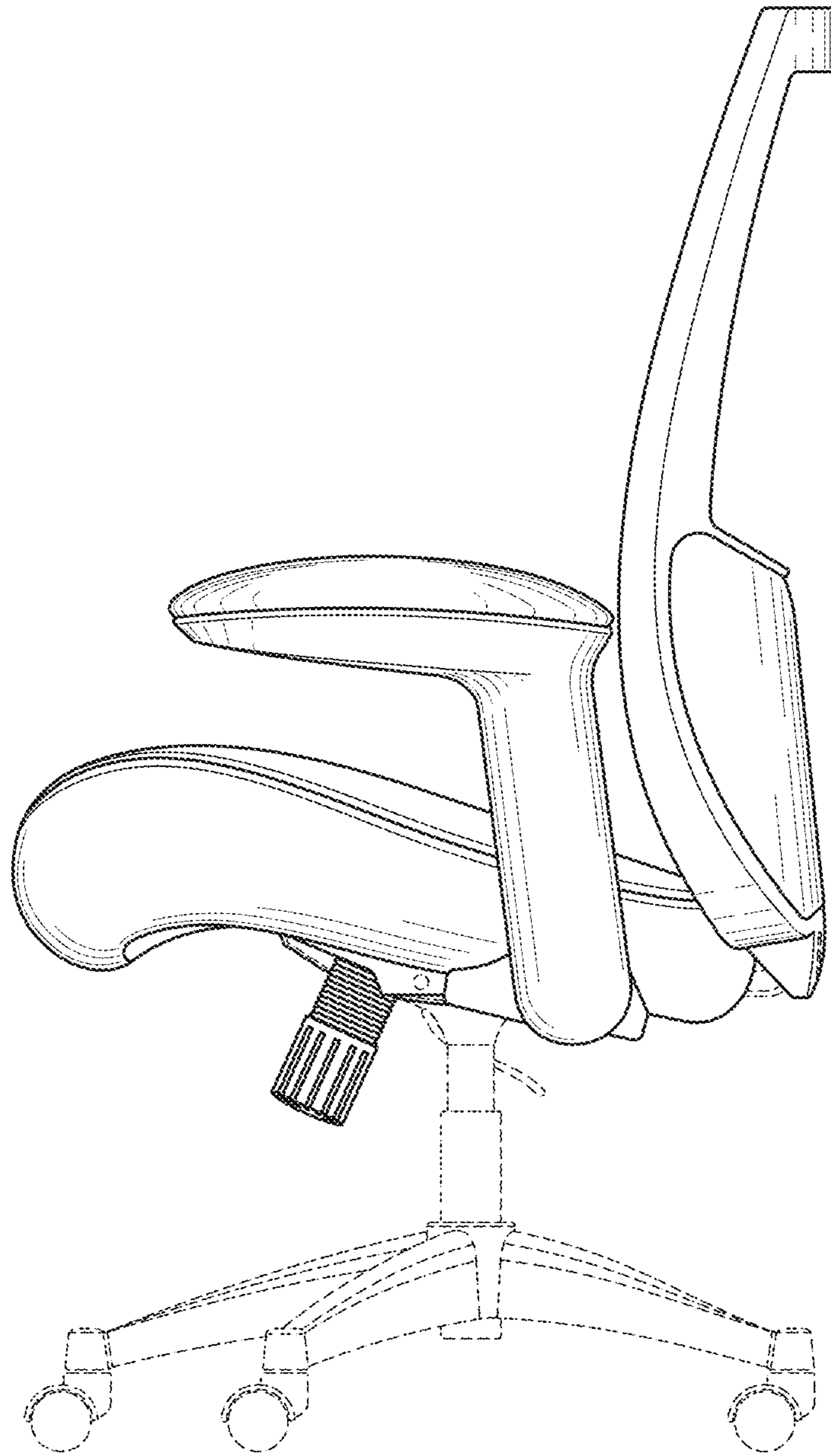

FIG. 5

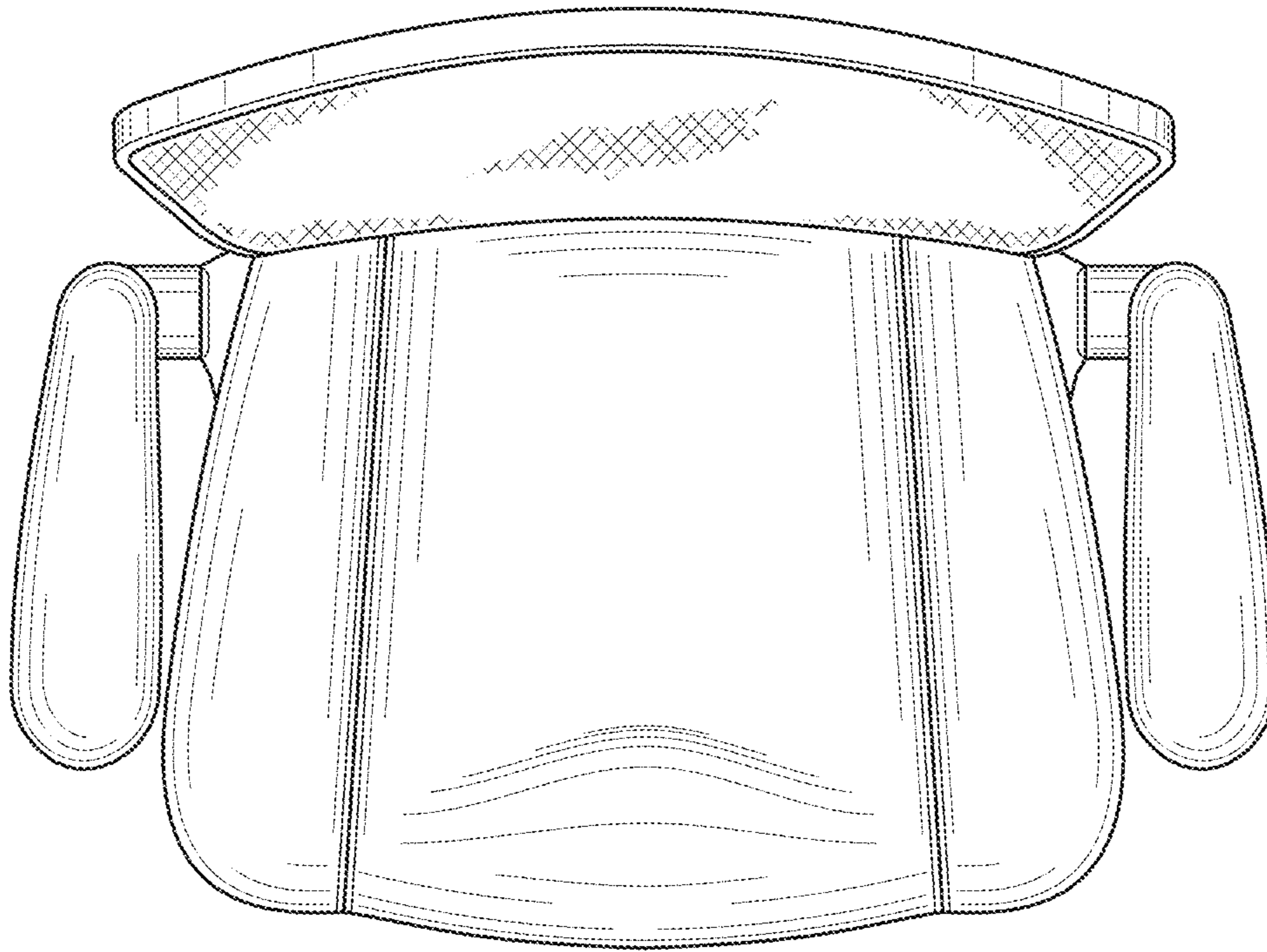

FIG. 6

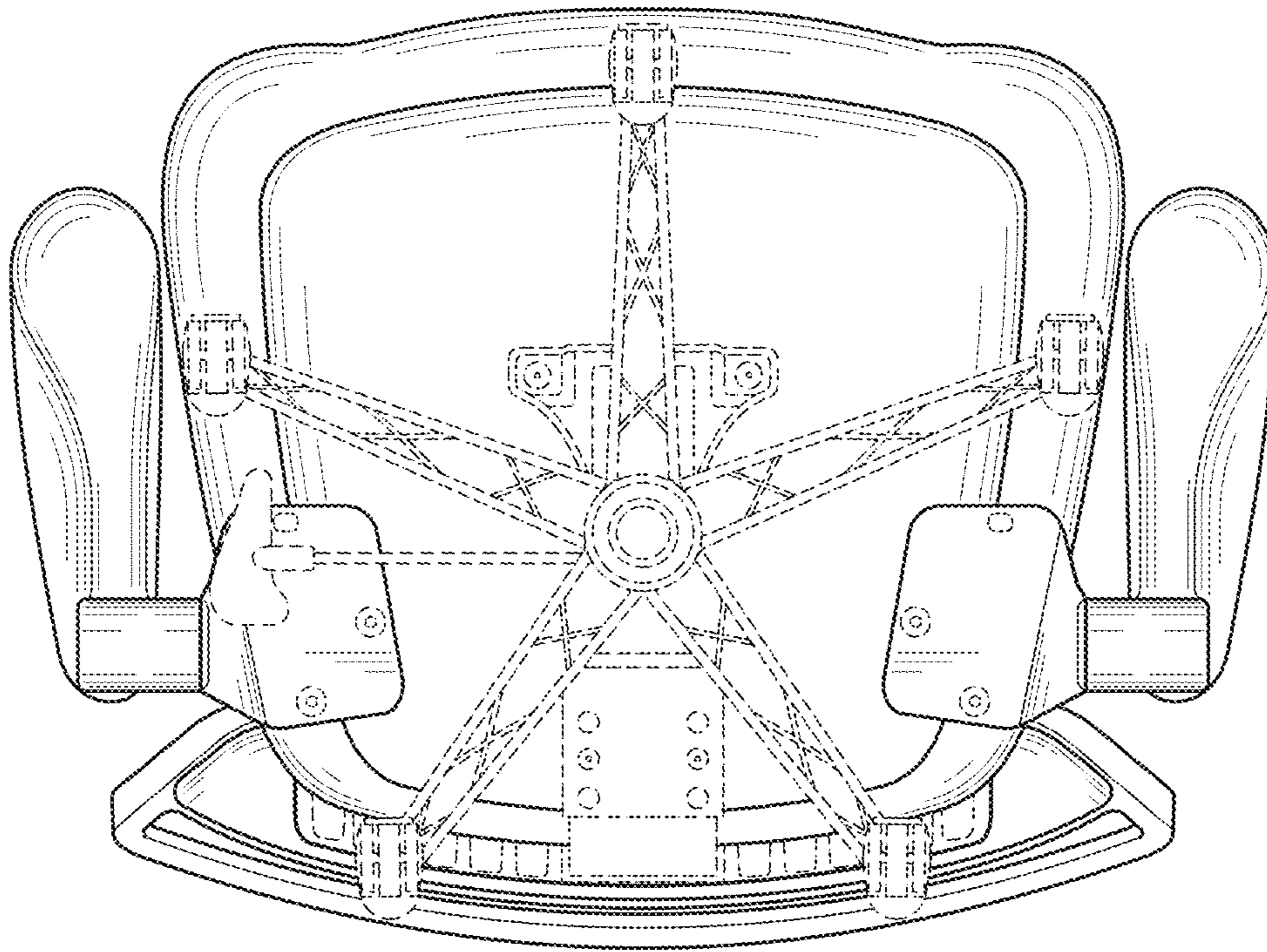

FIG. 7