



US00D950159S

(12) **United States Design Patent**
Agustsson

(10) **Patent No.:** **US D950,159 S**
(45) **Date of Patent:** **** Apr. 26, 2022**

(54) **HELMET**

(71) Applicant: **Globus (Shetland) Limited**, Lerwick (GB)

(72) Inventor: **Haraldur Agustsson**, Lerwick (GB)

(73) Assignee: **GLOBUS (SHETLAND) LIMITED**, Lerwick (GB)

(**) Term: **15 Years**

(21) Appl. No.: **29/720,045**

(22) Filed: **Jan. 9, 2020**

(30) **Foreign Application Priority Data**

Nov. 4, 2019 (EM) 007180286-0001
Nov. 4, 2019 (EM) 007180286-0002

(51) **LOC (13) Cl.** **29-02**

(52) **U.S. Cl.**
USPC **D29/102**

(58) **Field of Classification Search**
USPC D2/865, 870, 878, 892; D29/102, 103, D29/104, 105, 106, 107, 108, 109, 110, D29/112, 122
CPC A42B 3/00; A42B 3/04; A42B 3/06; A42B 3/065; A42B 3/066; A42B 3/10; A42B 3/166; A42B 3/22; A42B 3/221; A42B 3/225; A42B 3/226; A42B 3/227; A42B
(Continued)

(56) **References Cited**

U.S. PATENT DOCUMENTS

D326,001 S * 5/1992 Chiarella D29/102
D556,951 S * 12/2007 Gath D29/102
D602,640 S * 10/2009 Ho D29/102
(Continued)

OTHER PUBLICATIONS

ENHA Ranger helmet with crashbox, [online video]; [video published to the internet on Nov. 9, 2015]; [retrieved from the internet

on Jul. 27, 2021]; URL: <https://www.youtube.com/watch?v=n5cOg5WbH1E>. (1 pg). (Year: 2015).*

(Continued)

Primary Examiner — Jasmine Mlinarcik

(74) *Attorney, Agent, or Firm* — Eversheds Sutherland (US) LLP

(57) **CLAIM**

The ornamental design for a helmet, as shown and described.

DESCRIPTION

FIG. 1 is an upper perspective view of a helmet according to a first embodiment;
FIG. 2 is an lower perspective view thereof;
FIG. 3 is a front view thereof;
FIG. 4 is a rear view thereof;
FIG. 5 is a side view thereof;
FIG. 6 is a side view thereof;
FIG. 7 is a top view thereof;
FIG. 8 is a bottom view thereof;
FIG. 9 is a cross-sectional view taken from line 9 in FIG. 3 thereof;
FIG. 10 is an upper perspective view of a helmet according to a second embodiment;
FIG. 11 is an lower perspective view thereof;
FIG. 12 is a front view thereof;
FIG. 13 is a rear view thereof;
FIG. 14 is a side view thereof;
FIG. 15 is a side view thereof;
FIG. 16 is a top view thereof;
FIG. 17 is a bottom view thereof; and,
FIG. 18 is a cross-sectional view taken from line 18 in FIG. 12 thereof.

The broken lines define portions of the helmet that form no part of the claimed design.

1 Claim, 18 Drawing Sheets

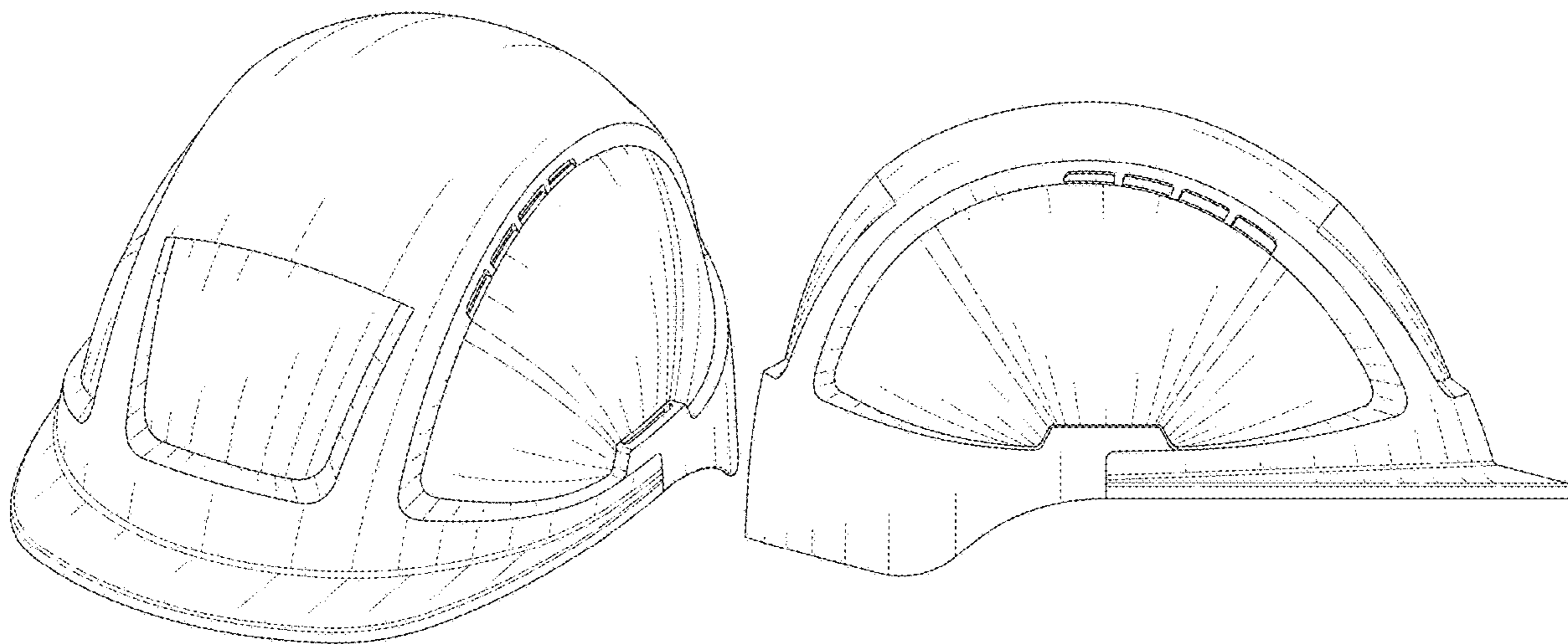

(58) **Field of Classification Search**

CPC .. 3/228; A42B 3/28; A42B 3/285; F41H 1/02;
F41H 1/04; F41H 1/06

See application file for complete search history.

(56) **References Cited**

U.S. PATENT DOCUMENTS

D695,460	S	*	12/2013	Slater	D29/102
D723,743	S	*	3/2015	Engelhard	D29/102
D733,972	S	*	7/2015	Szalkowski	D29/102
D870,389	S	*	12/2019	Ho	D29/102
10,779,599	B2	*	9/2020	Votel	A42B 1/08
D903,945	S	*	12/2020	Padgett	D29/102
2011/0083255	A1	*	4/2011	Krauter	A42B 3/283 2/410

OTHER PUBLICATIONS

Head Protection From ENHA, [online]; [Wayback Machine Internet crawl-back date found for Jan. 28, 2019]; [retrieved from the internet on Jul. 27, 2021]; URL: <https://web.archive.org/web/20190128042159/https://www.alphasolway.com/head-protection>. (3 pgs). (Year: 2019).*

* cited by examiner

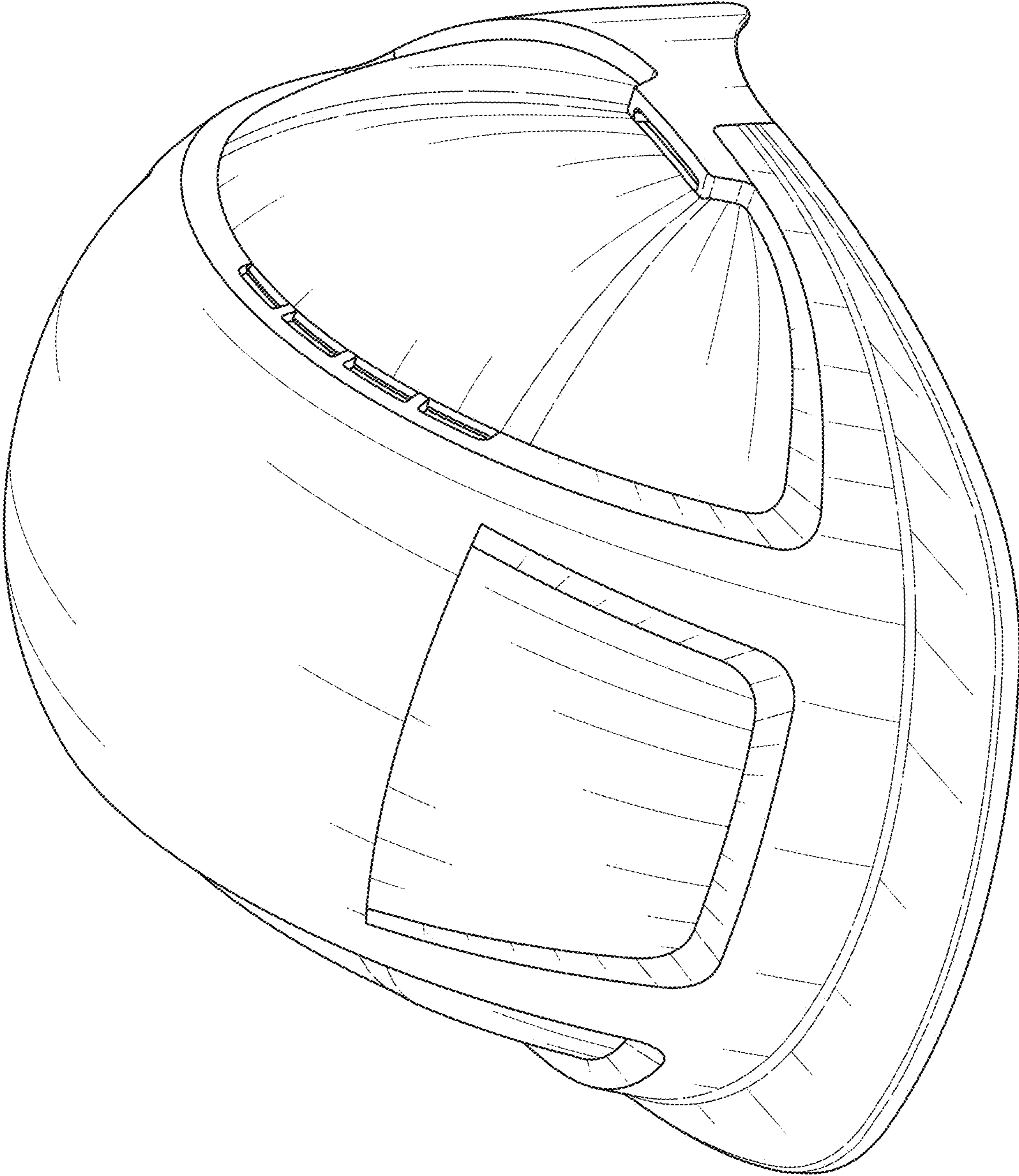

FIG. 1

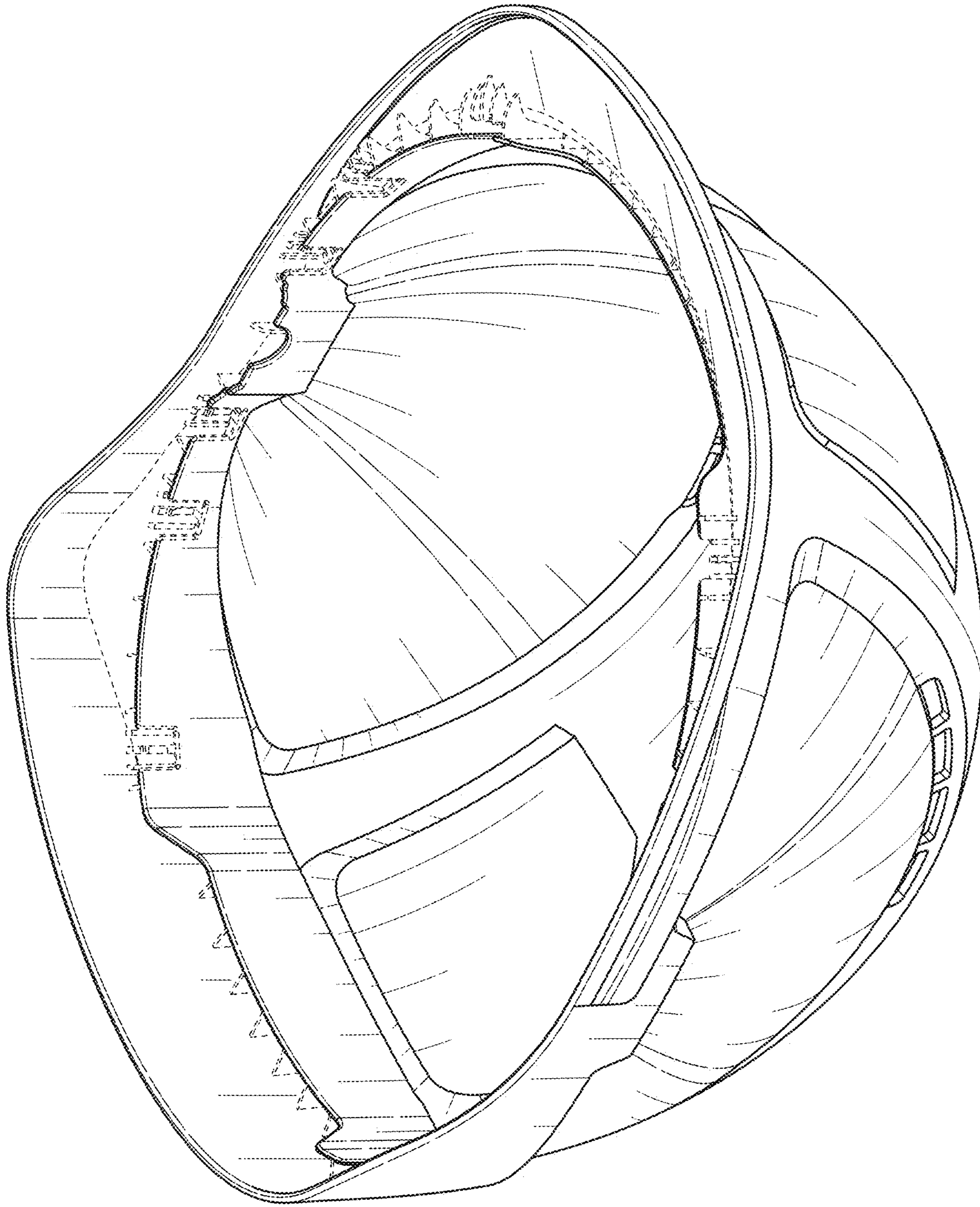

FIG. 2

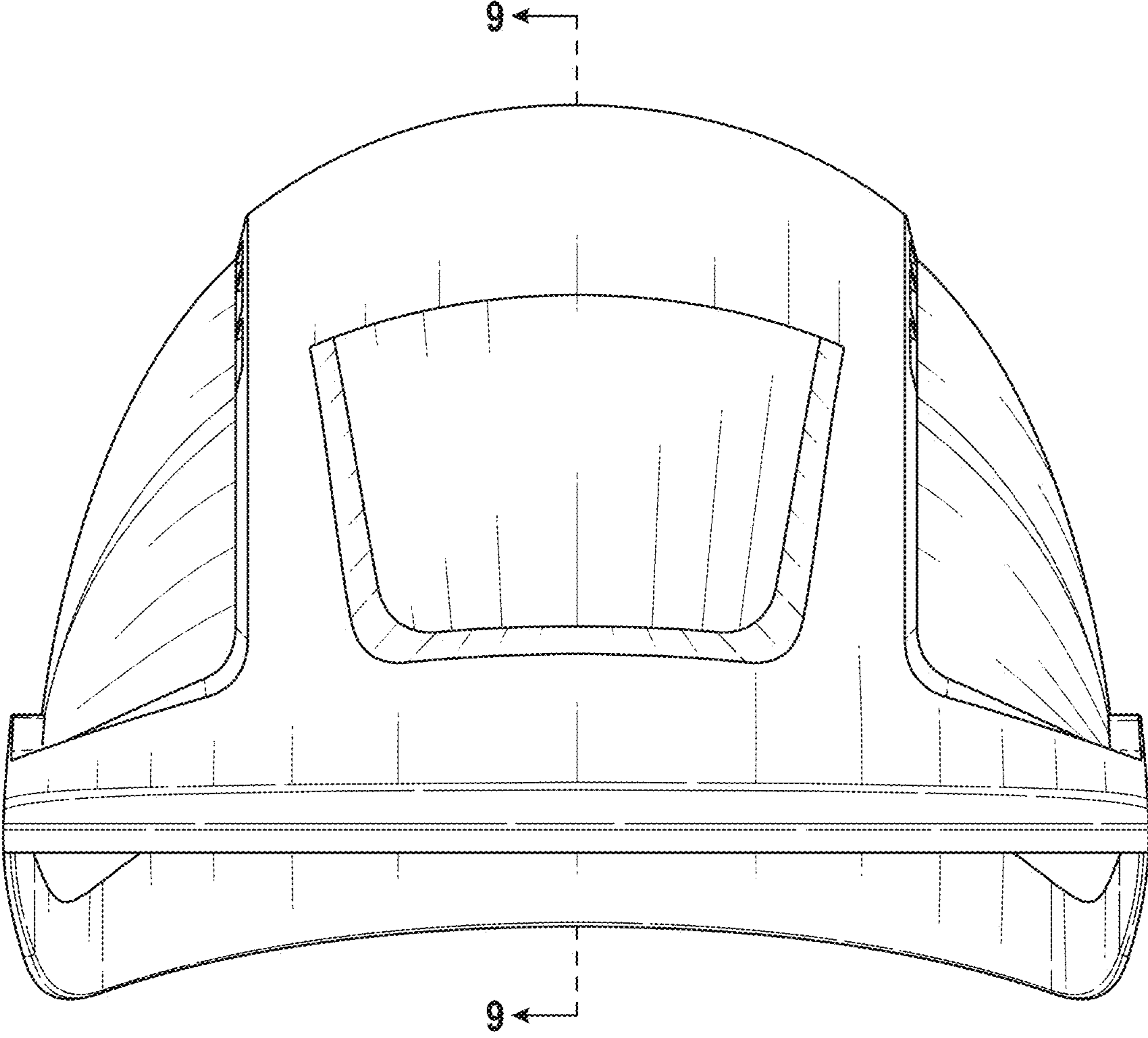

FIG. 3

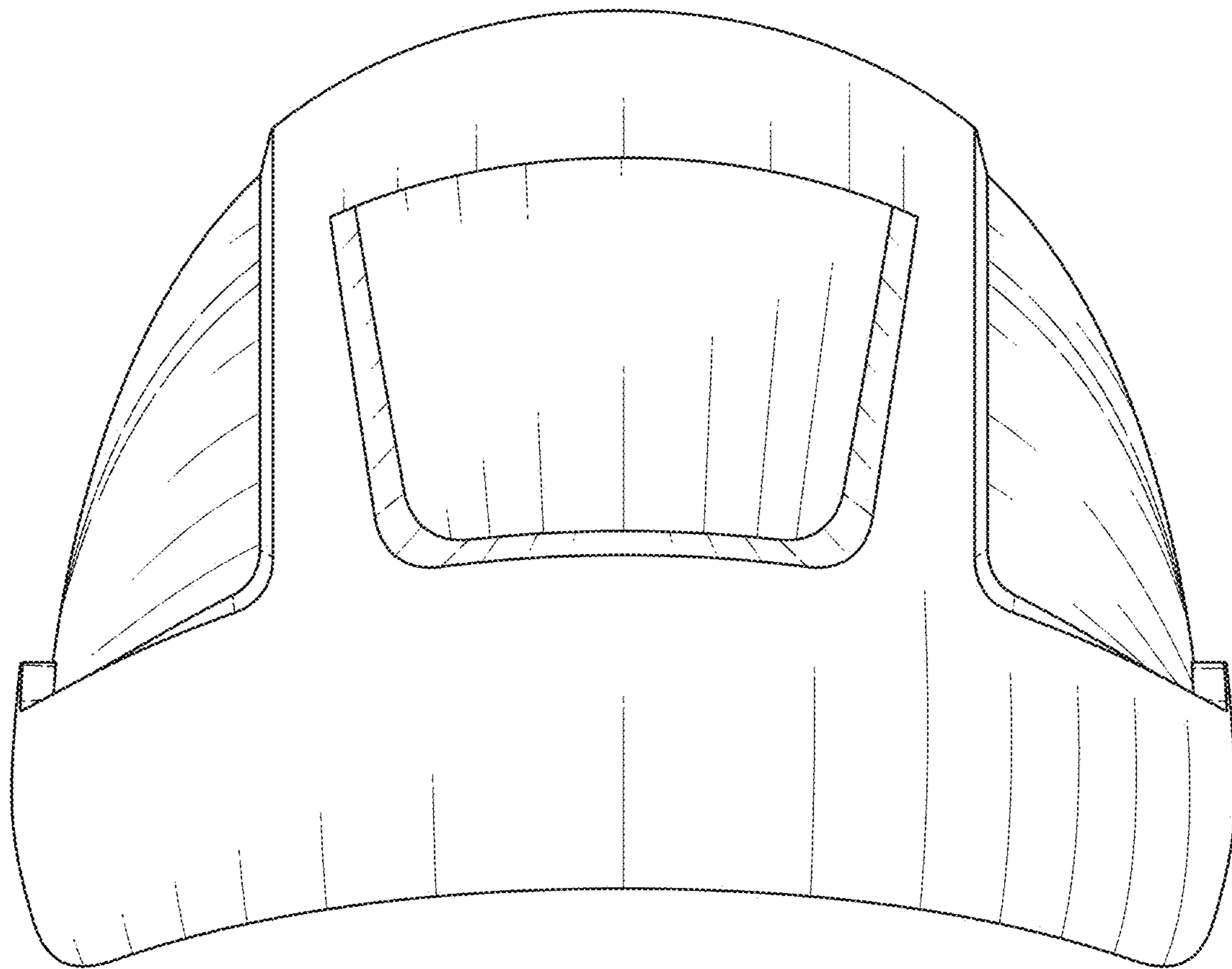

FIG. 4

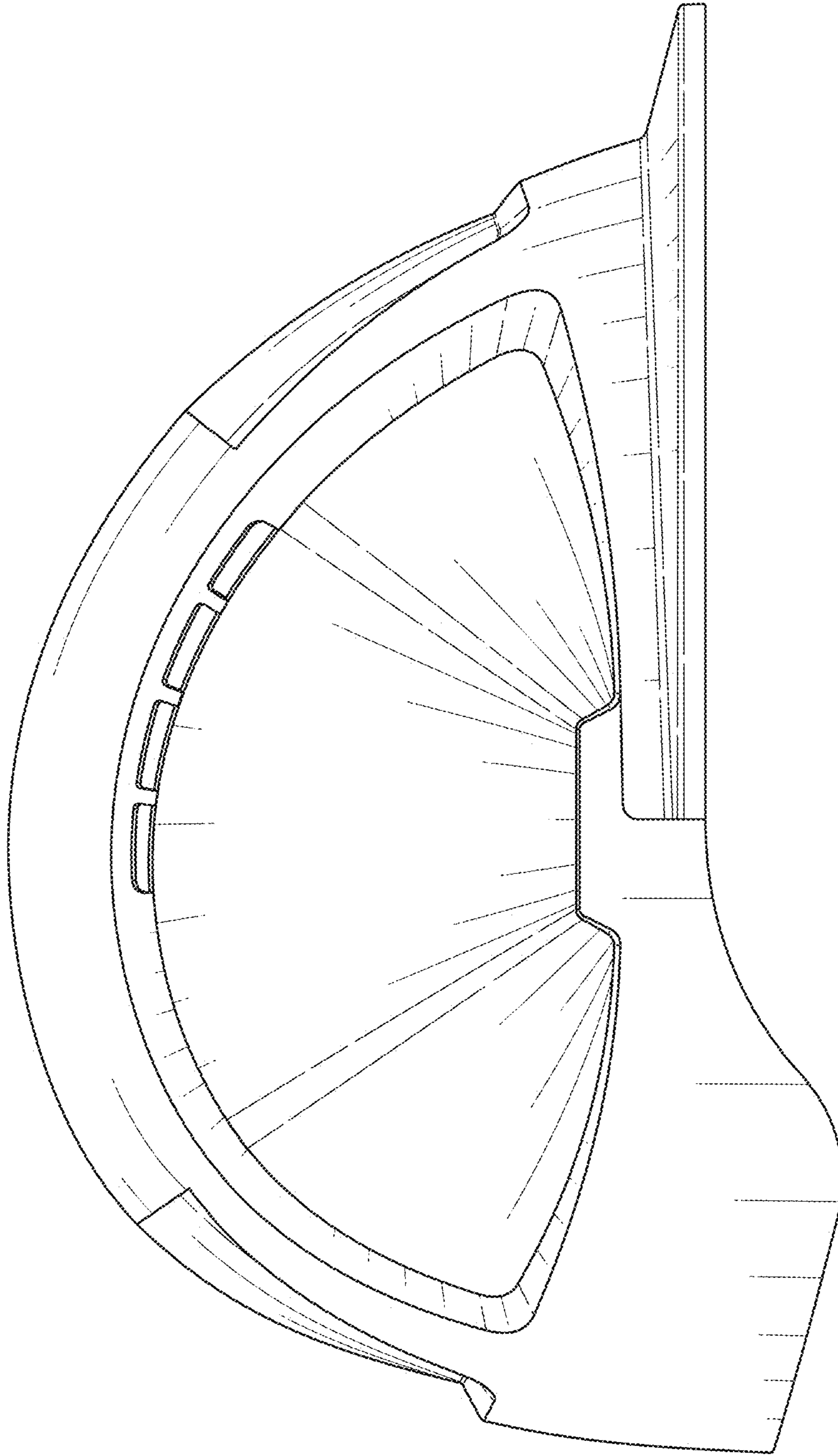

FIG. 5

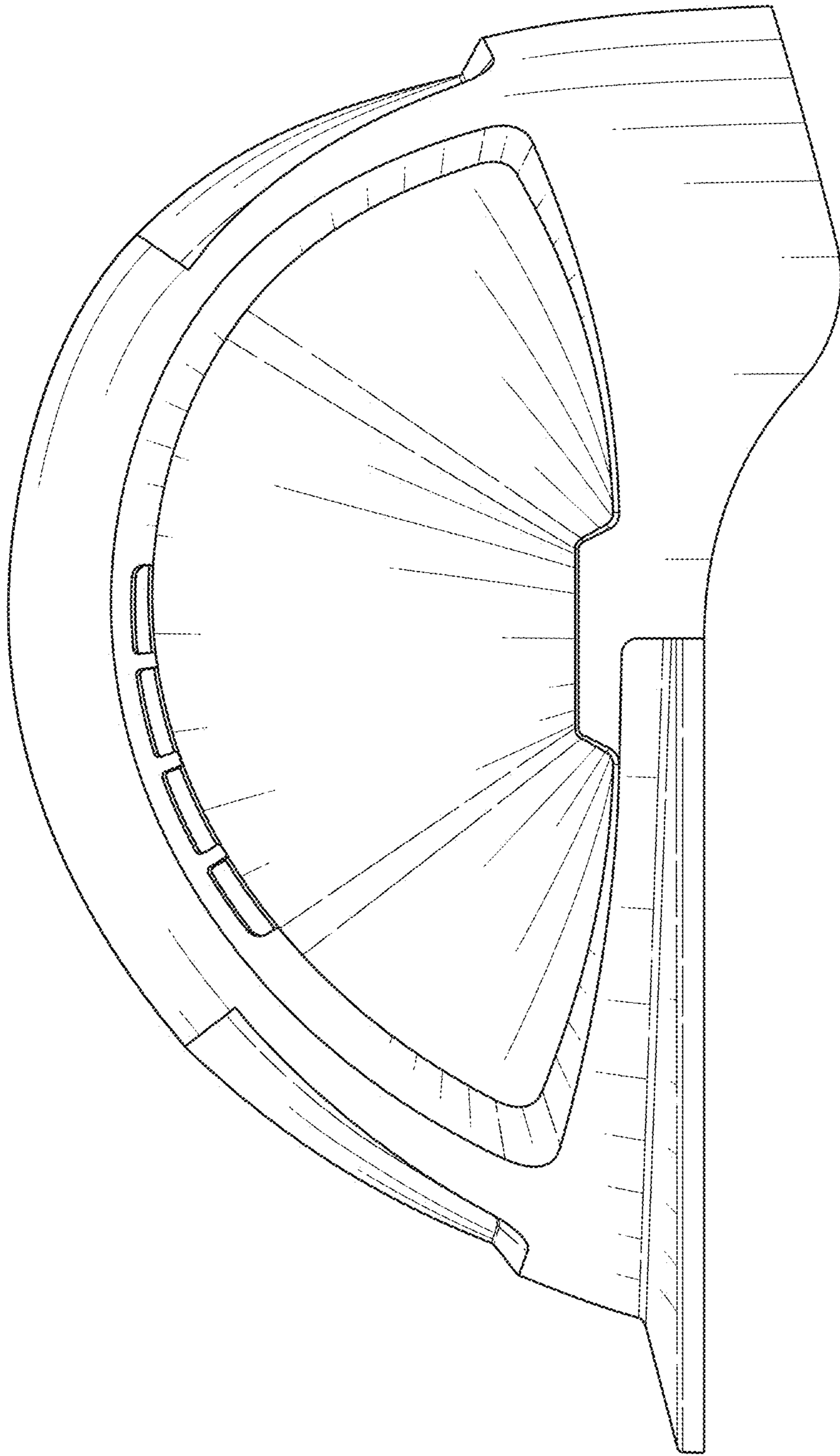

FIG. 6

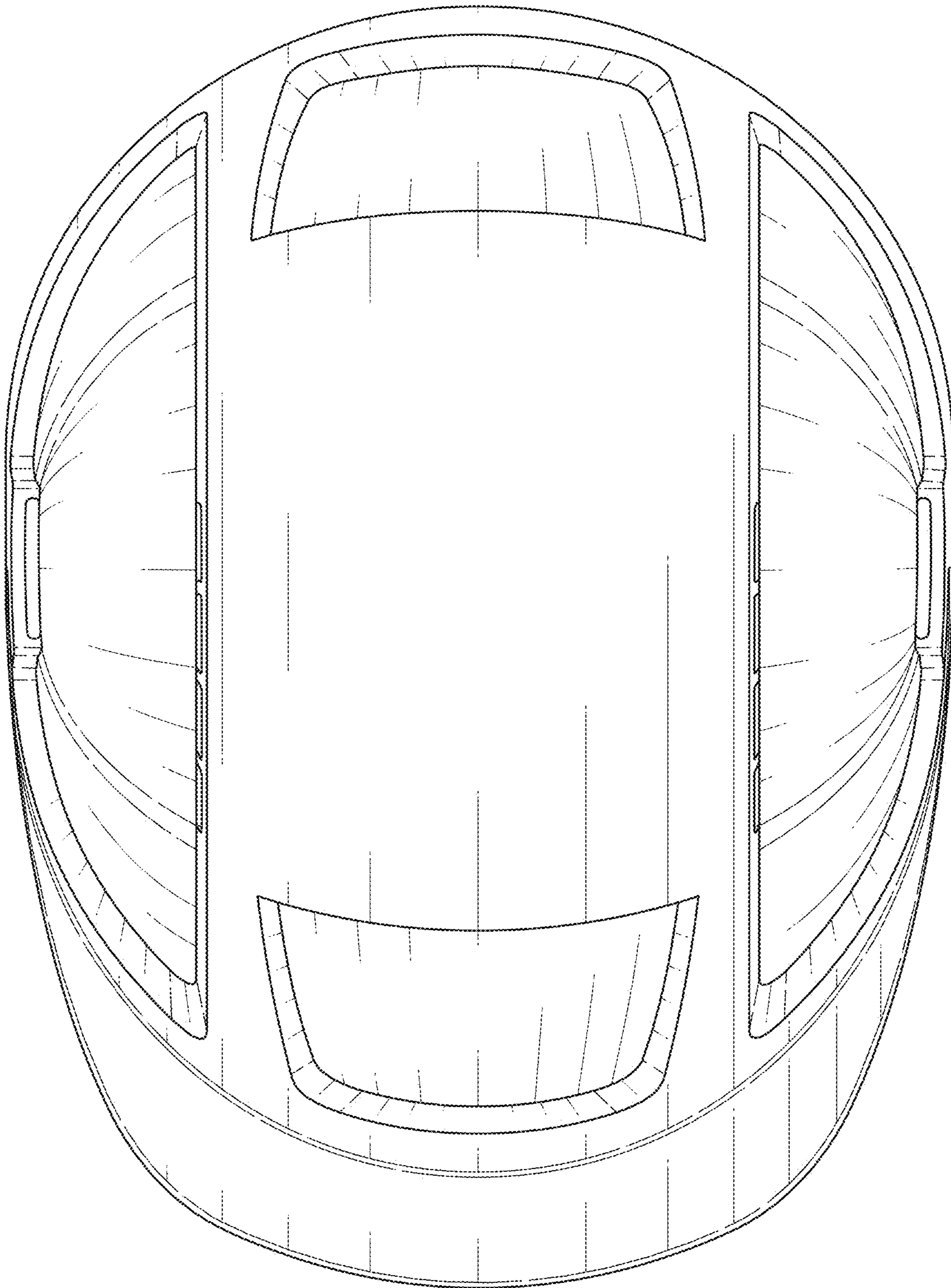

FIG. 7

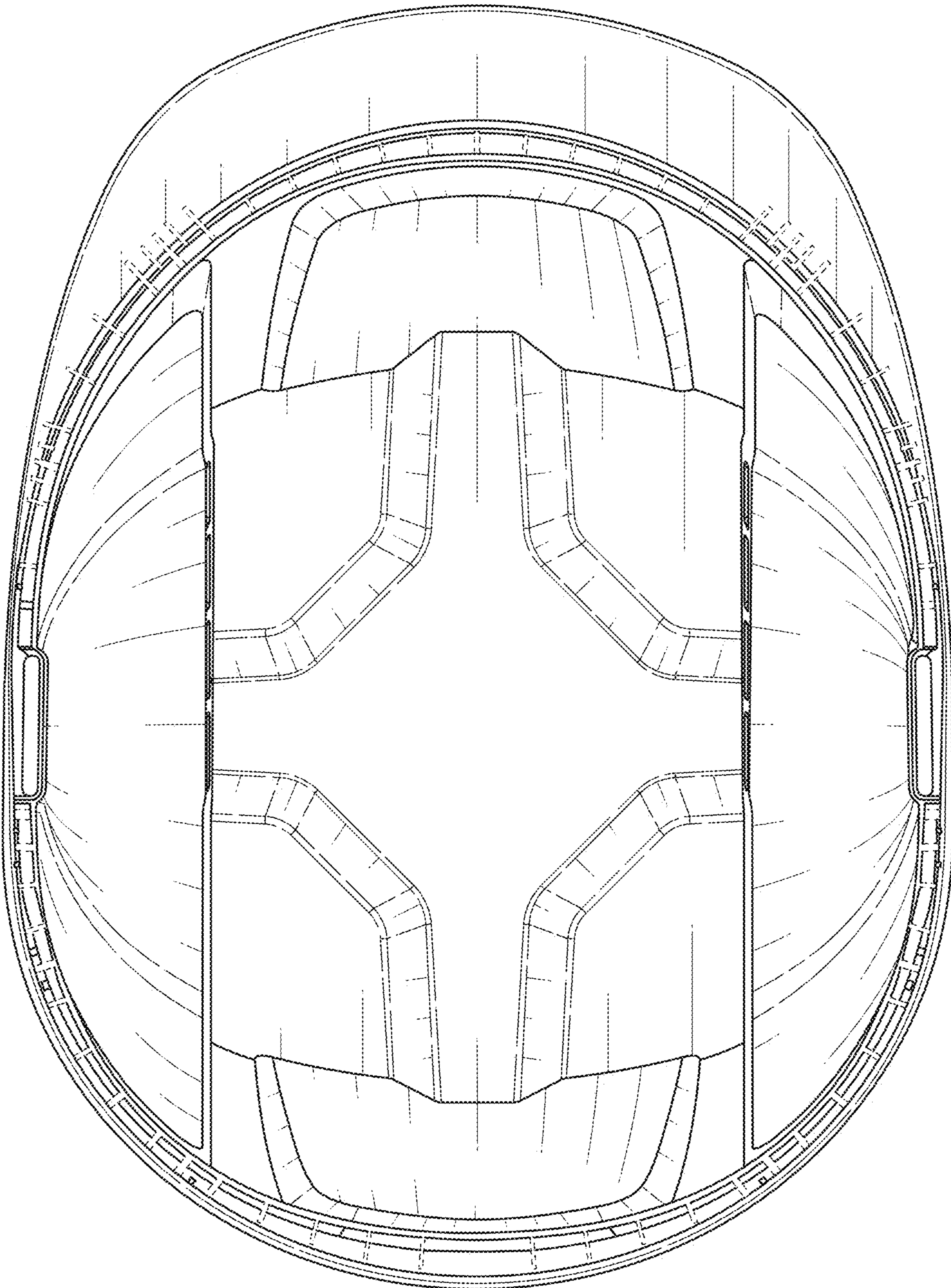

FIG. 8

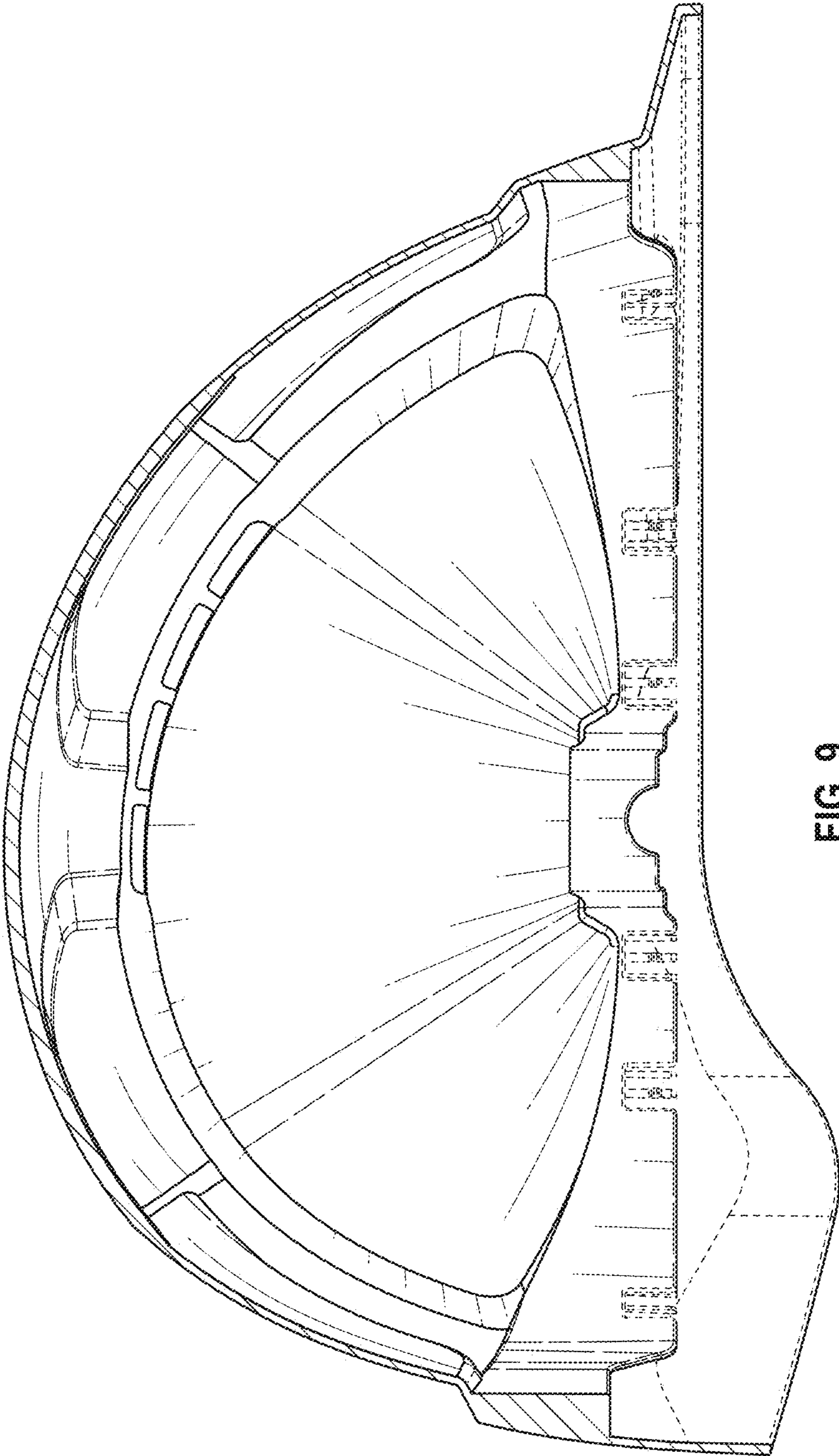

FIG. 9

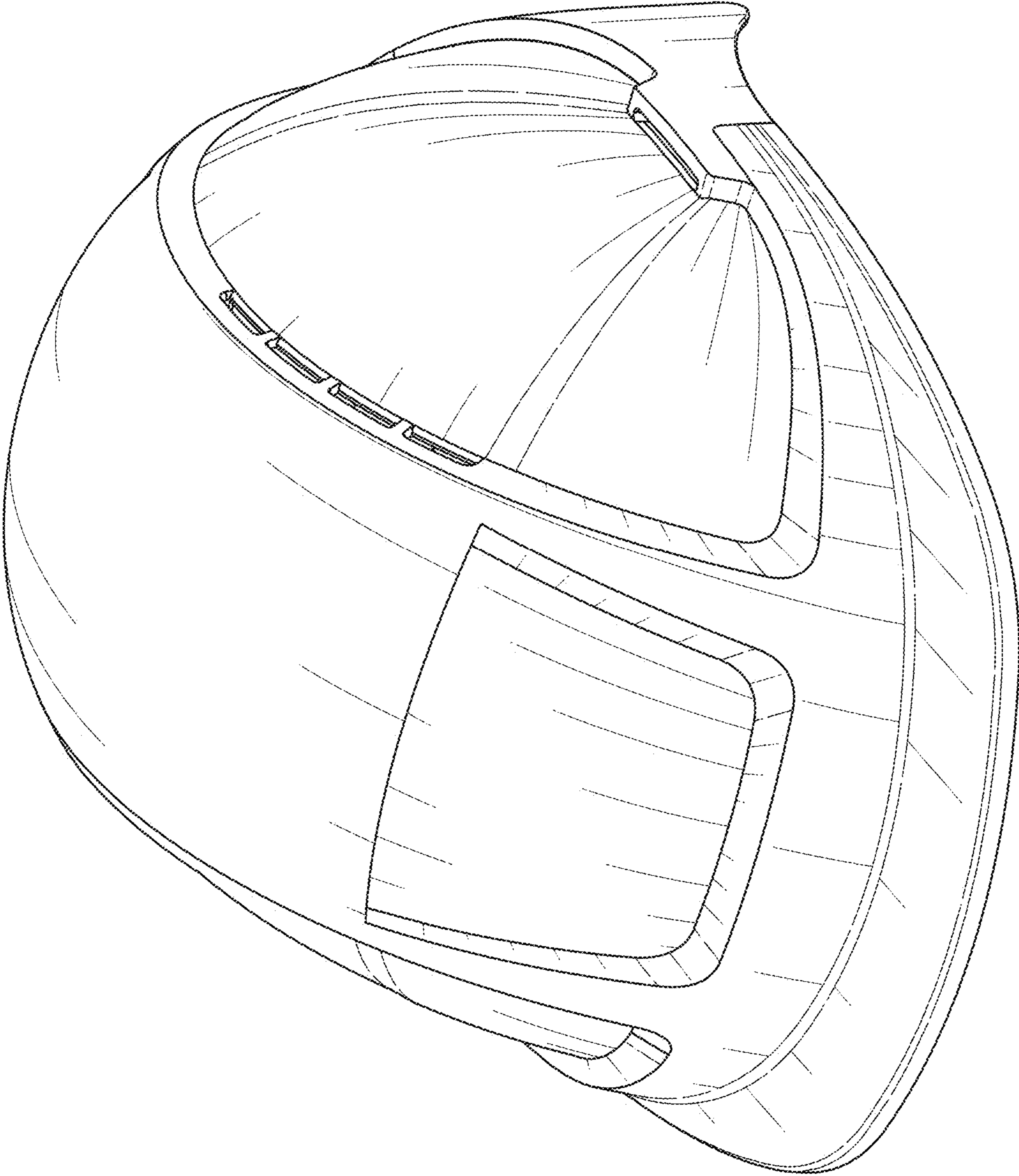

FIG. 10

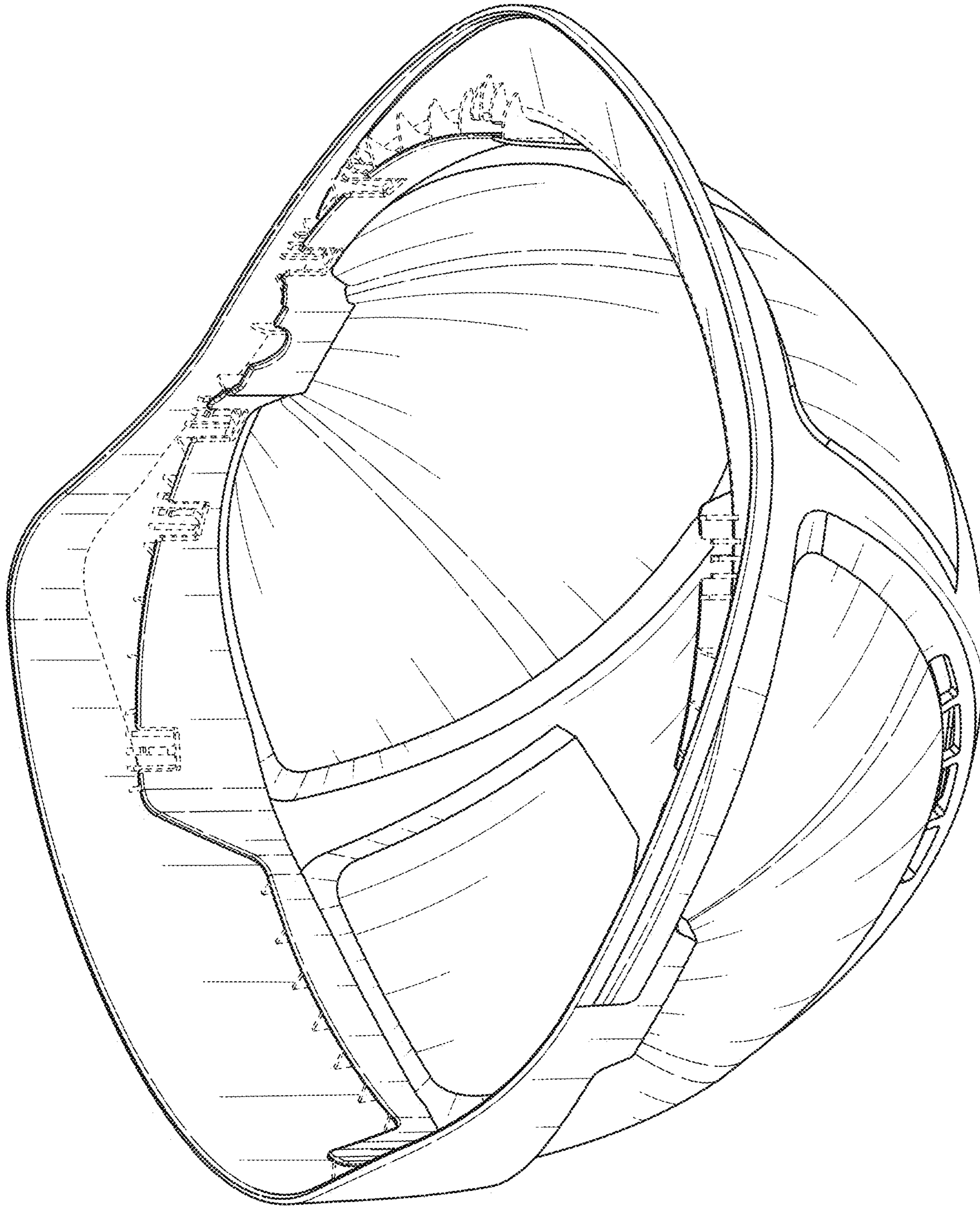

FIG. 11

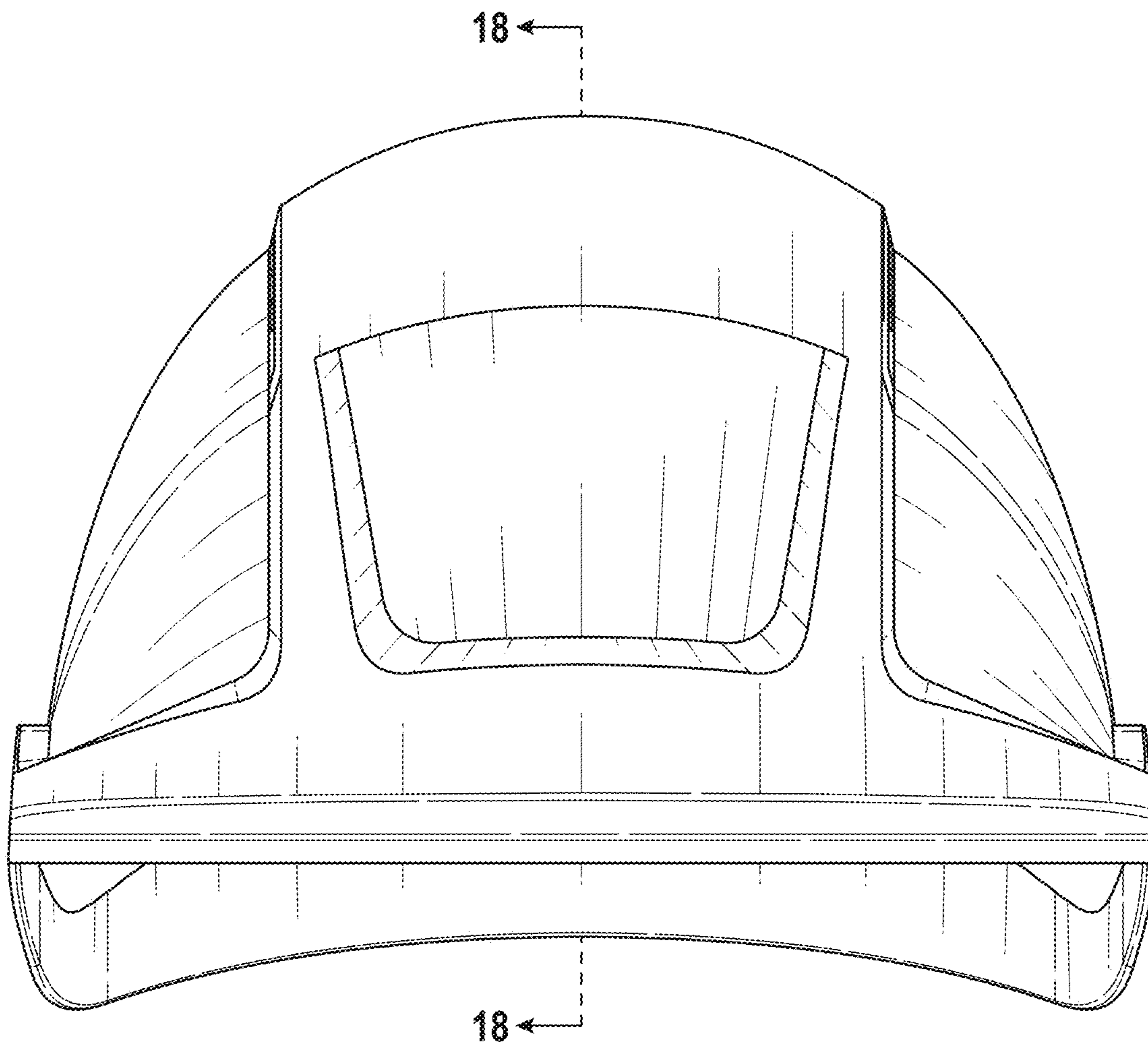

FIG. 12

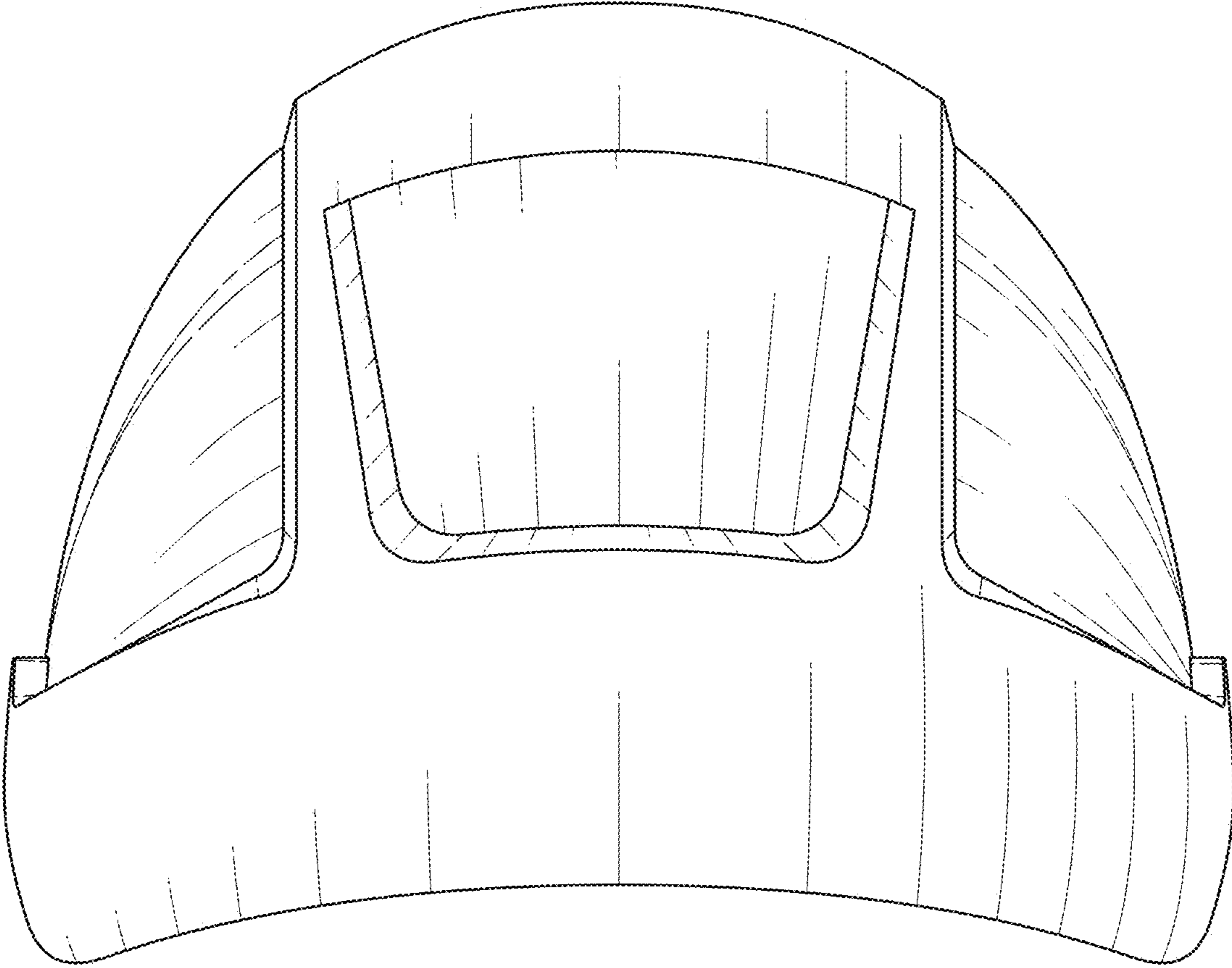

FIG. 13

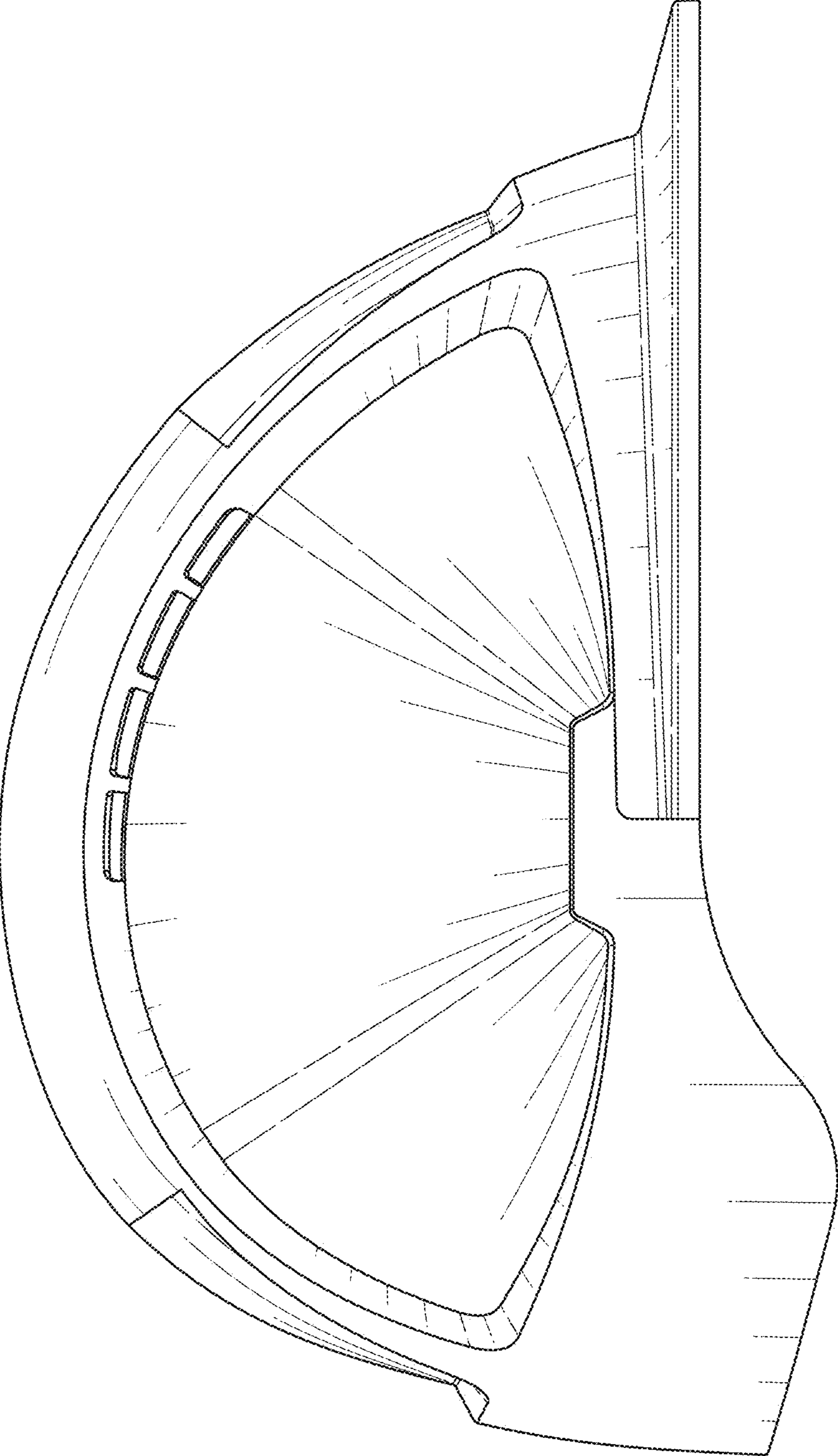

FIG. 14

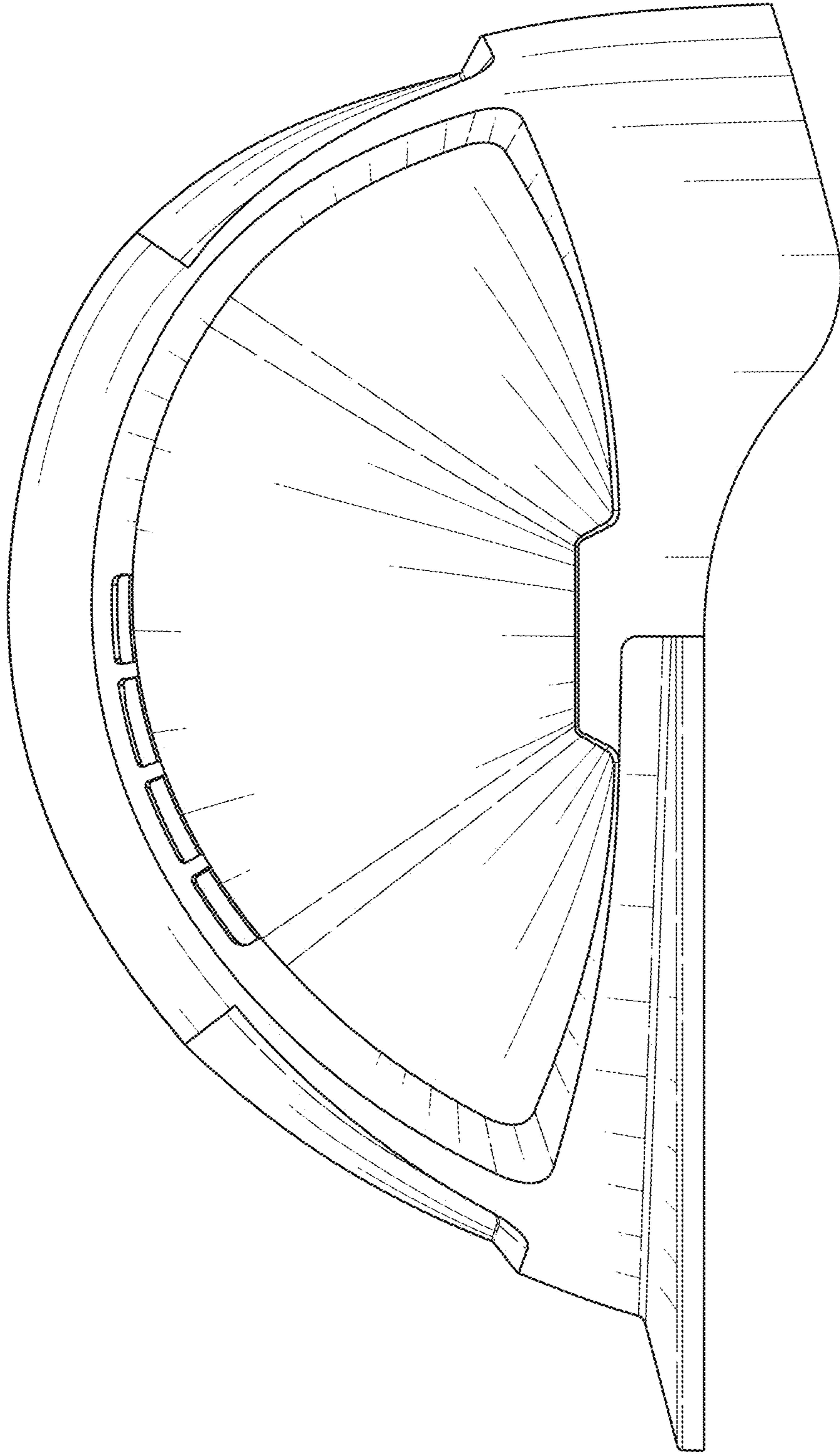

FIG. 15

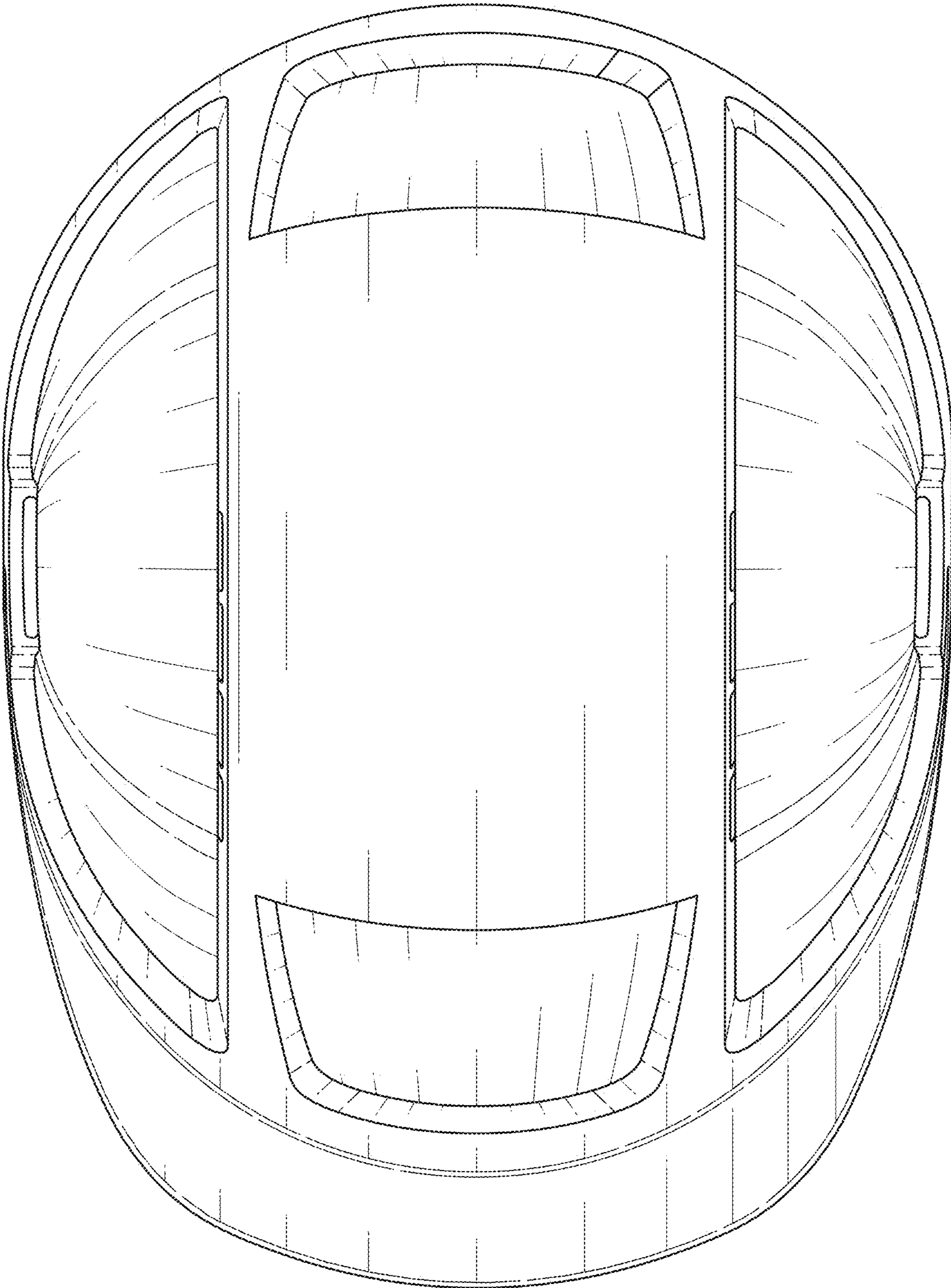

FIG. 16

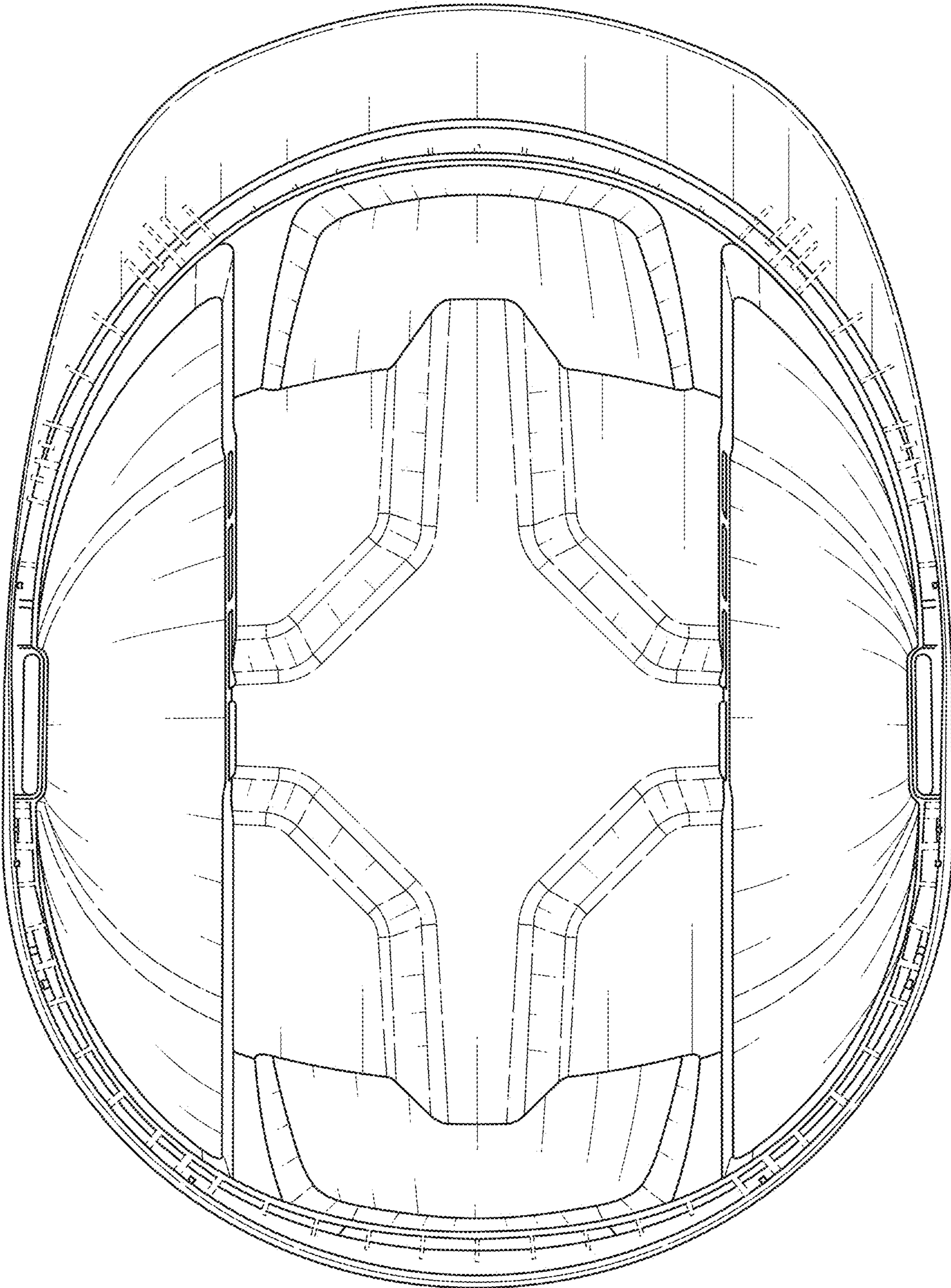

FIG. 17

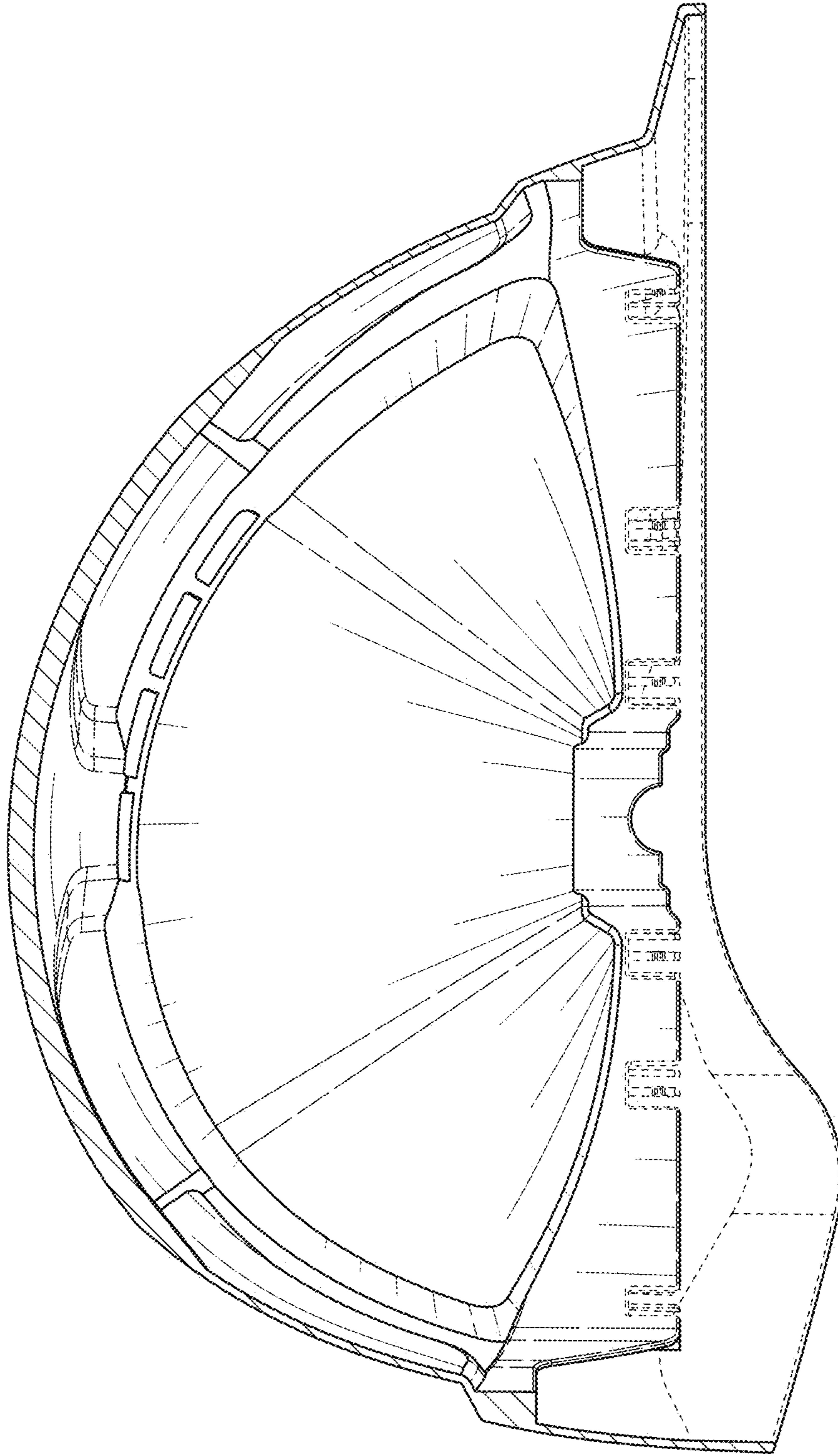

FIG. 18