



US00D950108S

(12) **United States Design Patent**
Ryan

(10) **Patent No.:** **US D950,108 S**
(45) **Date of Patent:** **** *Apr. 26, 2022**

(54) **ROOFING DECK**

(71) Applicant: **Epic Metals Corporation**, Rankin, PA (US)

(72) Inventor: **Thomas G. Ryan**, Ligonier, PA (US)

(73) Assignee: **Epic Metals Corporation**, Rankin, PA (US)

(*) Notice: This patent is subject to a terminal disclaimer.

(**) Term: **15 Years**

(21) Appl. No.: **29/688,587**

(22) Filed: **Apr. 23, 2019**

(51) **LOC (13) Cl.** **25-01**

(52) **U.S. Cl.**
USPC **D25/143; D25/120**

(58) **Field of Classification Search**
USPC D25/119-125, 138, 139, 141-144, 158, D25/159

(Continued)

(56) **References Cited**

U.S. PATENT DOCUMENTS

3,707,088 A * 12/1972 King B21D 13/045
72/178
4,133,158 A * 1/1979 Ting E04C 2/322
52/478

(Continued)

OTHER PUBLICATIONS

Epic Metals Corporation, *Toris Roof and Floor Deck Ceiling Systems*, pp. 1-20, 2009, Rankin, PA.

Primary Examiner — Llorellys Martinez

(74) *Attorney, Agent, or Firm* — The Webb Law Firm

(57) **CLAIM**

The ornamental design for a roofing deck, as shown and described.

DESCRIPTION

FIG. 1 is a front view of a roofing deck showing my new design in accordance with a first embodiment of the present invention;

FIG. 2 is a rear view thereof;

FIG. 3 is a right side view thereof;

FIG. 4 is a left side view thereof;

FIG. 5 is a bottom view thereof;

FIG. 6 is a top view thereof;

FIG. 7 is a lower right front perspective view thereof;

FIG. 8 is a lower right front perspective view of the roofing deck of FIG. 1, show in an alternate configuration;

FIG. 9 is a front view of a roofing deck showing my new design in accordance with a second embodiment of the present invention;

FIG. 10 is a rear view thereof;

FIG. 11 is a right side view thereof;

FIG. 12 is a left side view thereof;

FIG. 13 is a bottom view thereof;

FIG. 14 is a top view thereof;

FIG. 15 is a lower right front perspective view thereof;

FIG. 16 is a front view of a roofing deck showing my new design in accordance with a third embodiment of the present invention;

FIG. 17 is a rear view thereof;

FIG. 18 is a right side view thereof;

FIG. 19 is a left side view thereof;

FIG. 20 is a bottom view thereof;

FIG. 21 is a top view thereof;

FIG. 22 is a lower right front perspective view thereof; and,

FIG. 23 is a lower right front perspective view of the roofing deck of FIG. 16, shown in an alternate configuration.

The broken line showings of FIGS. 9-15 represent portions of the roofing deck that form no part of the claimed design. In FIGS. 3-8, 11-15, and 18-23, the roofing deck is shown with a symbolic break in its length, the appearance of any portion of the roofing deck extending beyond the symbolic break forming no part of the claimed design. The other broken lines in FIGS. 8 and 23 showing a roofing deck assembly represent environmental subject matter only and form no part of the claimed design.

1 Claim, 20 Drawing Sheets

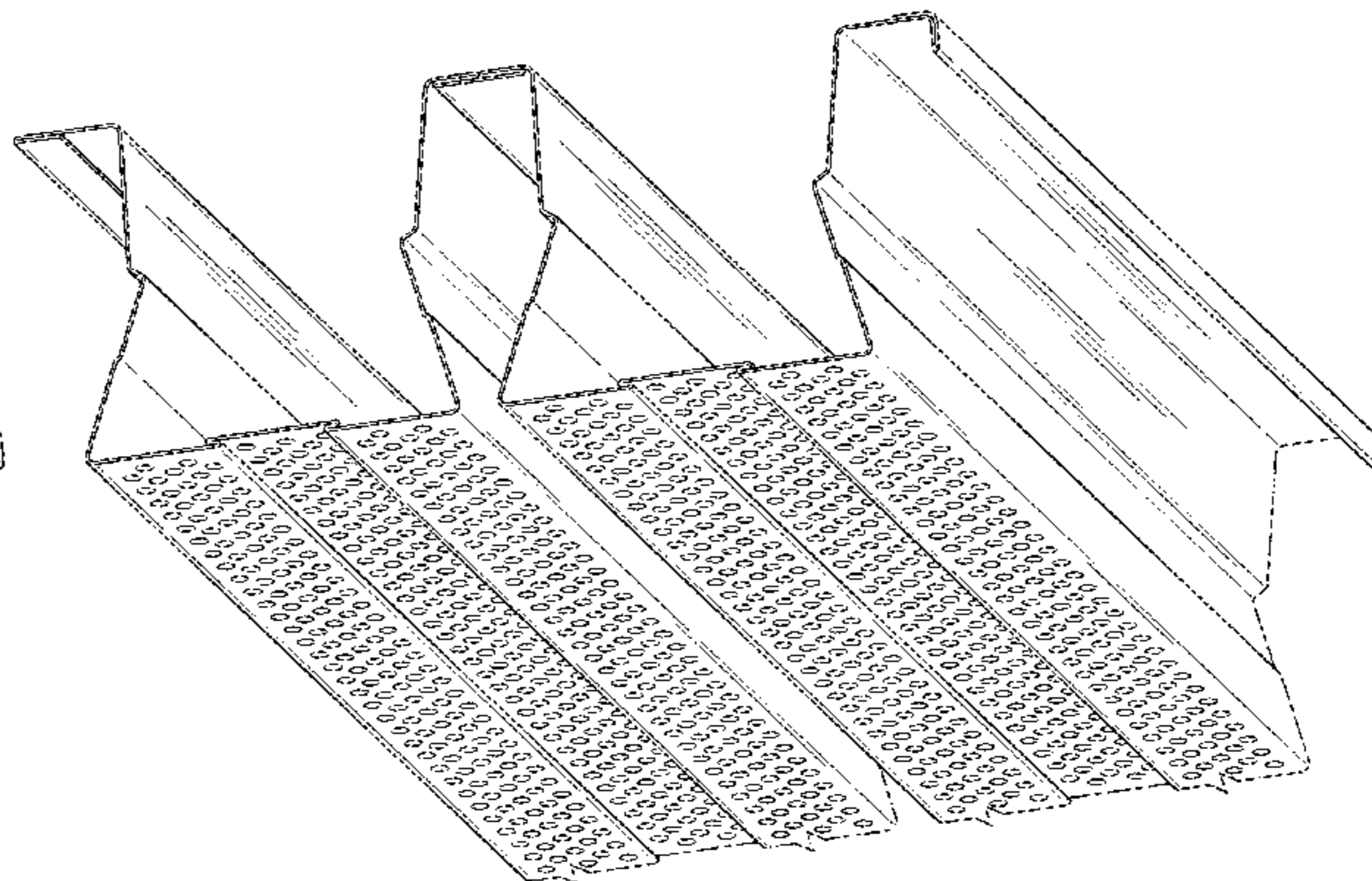
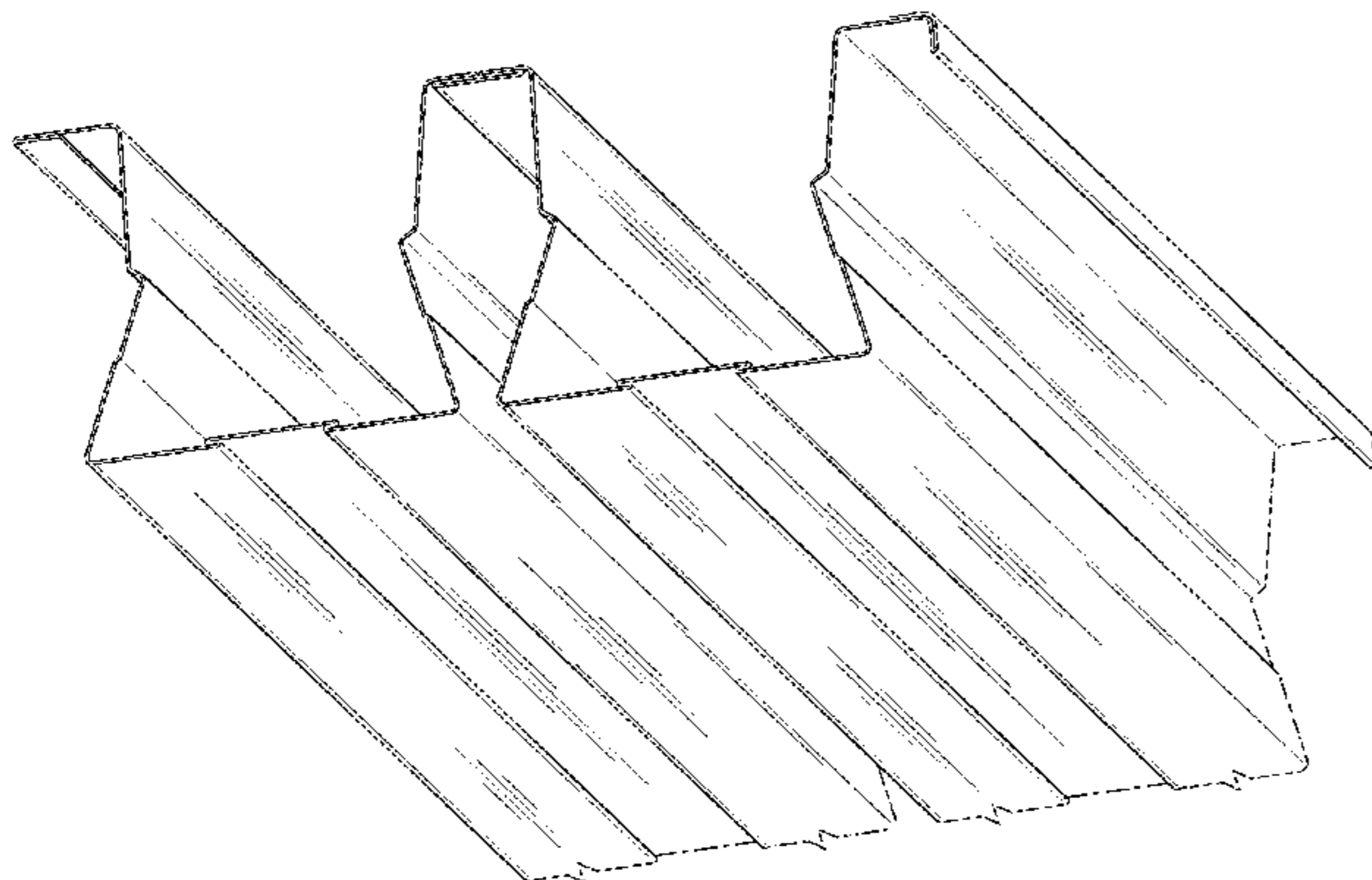

(58) **Field of Classification Search**

CPC E04B 9/0435; E04B 9/0464; E04C 2/08;
 E04C 2/32; E04C 2/322; E04D 3/30;
 E04D 3/36; E04F 15/06

See application file for complete search history.

(56) **References Cited**

U.S. PATENT DOCUMENTS

D256,620	S *	8/1980	Madsen	D25/119
4,454,692	A *	6/1984	Ault	E04B 5/40 174/486
4,507,900	A	4/1985	Landis		
D337,169	S *	7/1993	Schipp	D25/153
5,393,173	A *	2/1995	Morello	E04C 2/08 405/151
D443,368	S *	6/2001	Eaton	D25/121
6,415,581	B1 *	7/2002	Shipman	E04C 2/322 428/593
D507,665	S	7/2005	Ryan et al.		
D511,580	S	11/2005	Ryan et al.		
D608,464	S	1/2010	Ryan		
D622,417	S	8/2010	Ryan		
D623,773	S *	9/2010	Ryan	D25/153
D648,445	S *	11/2011	Ryan	D25/121
D655,022	S *	2/2012	Ryan	D25/121
D663,045	S *	7/2012	Ryan	D25/125
D713,554	S	9/2014	Ryan		
D785,209	S	4/2017	Ryan		
D817,519	S	5/2018	Ryan		
D831,234	S *	10/2018	Clayton	D25/141
2004/0231272	A1 *	11/2004	Patrick	E04C 2/322 52/508
2016/0333584	A1 *	11/2016	Bogh	E04C 2/32
2020/0340247	A1 *	10/2020	Ryan	E04C 2/322
2020/0354972	A1 *	11/2020	Bogh	E04F 15/06

* cited by examiner

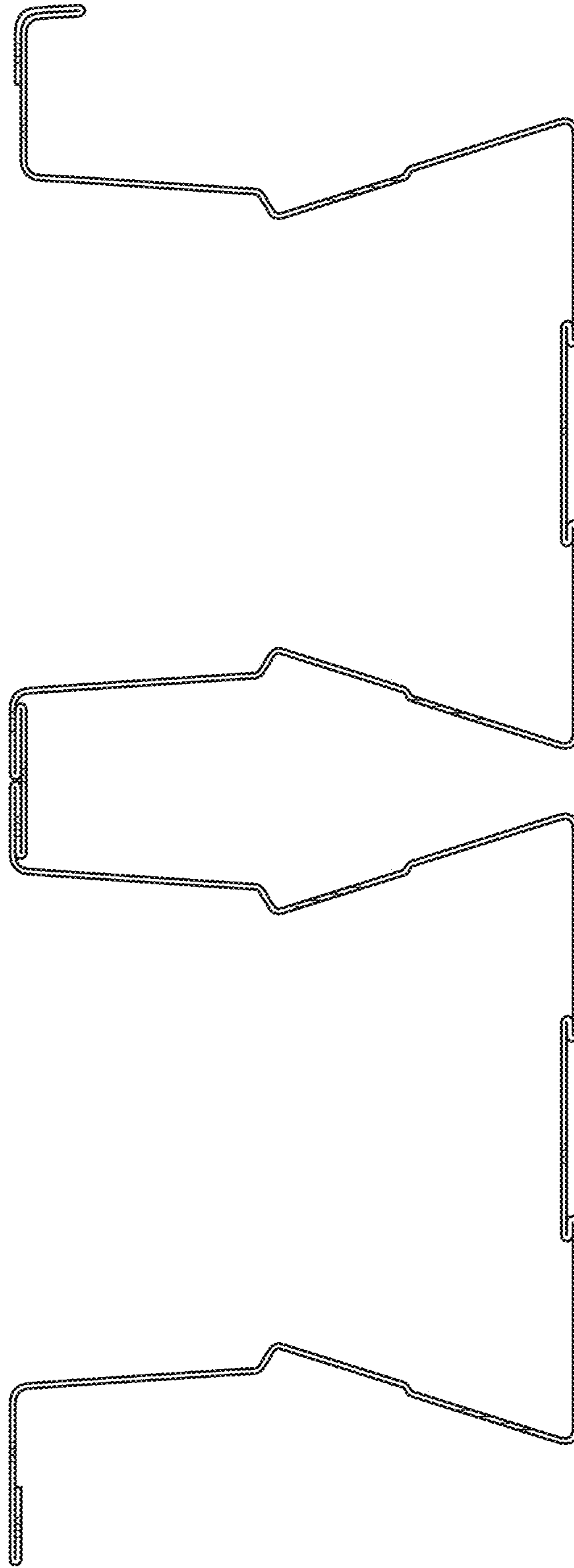

FIG. 1

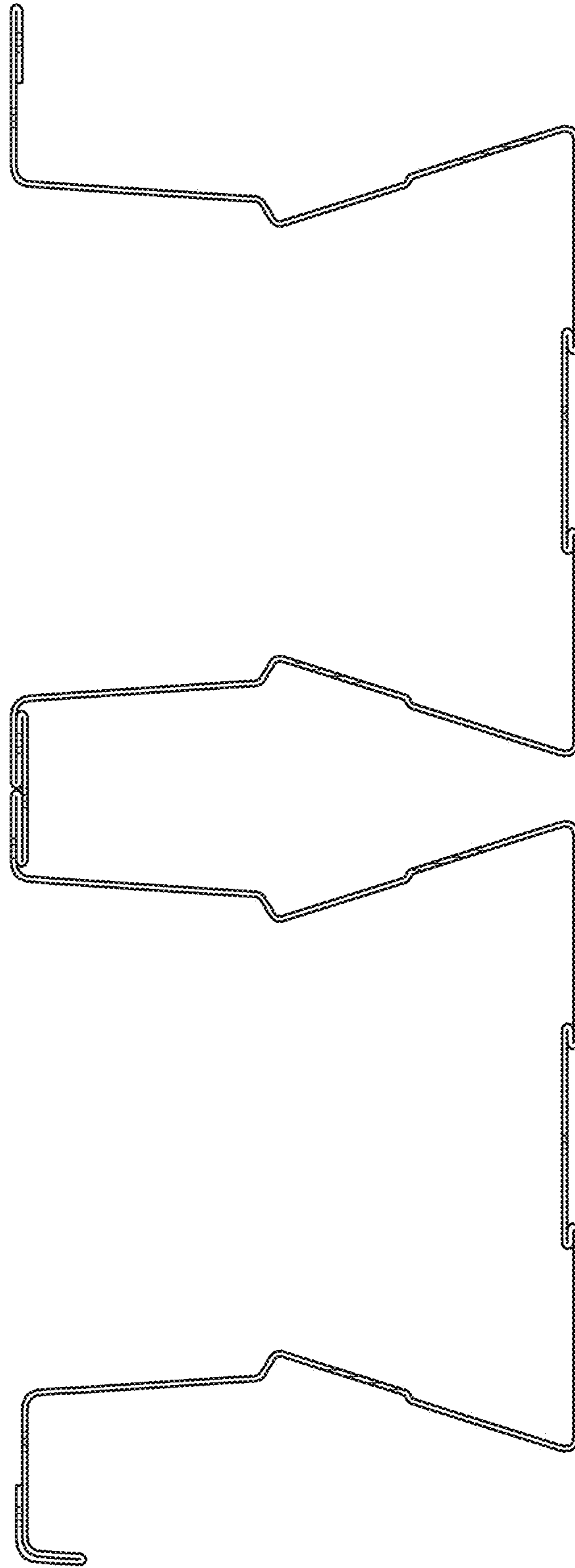

FIG. 2

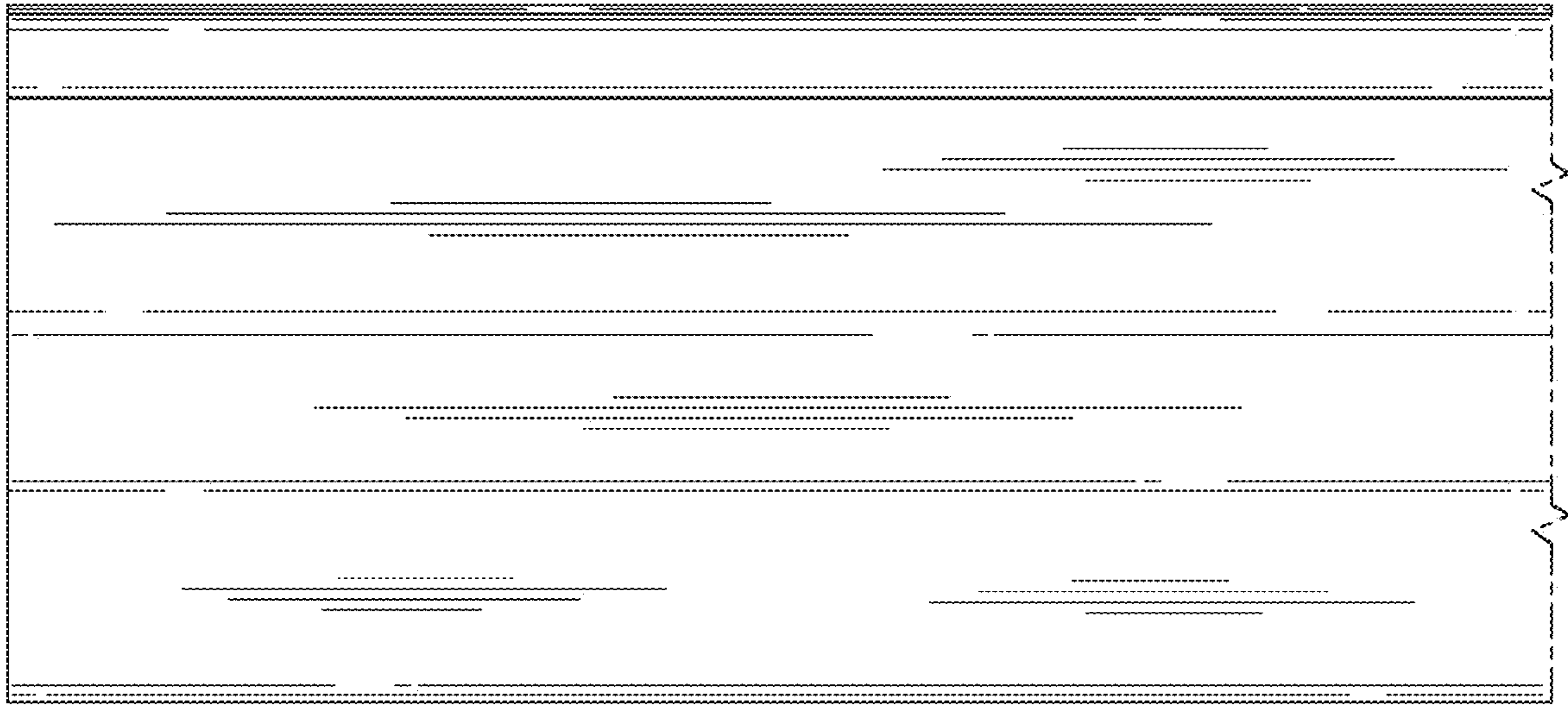

FIG. 3

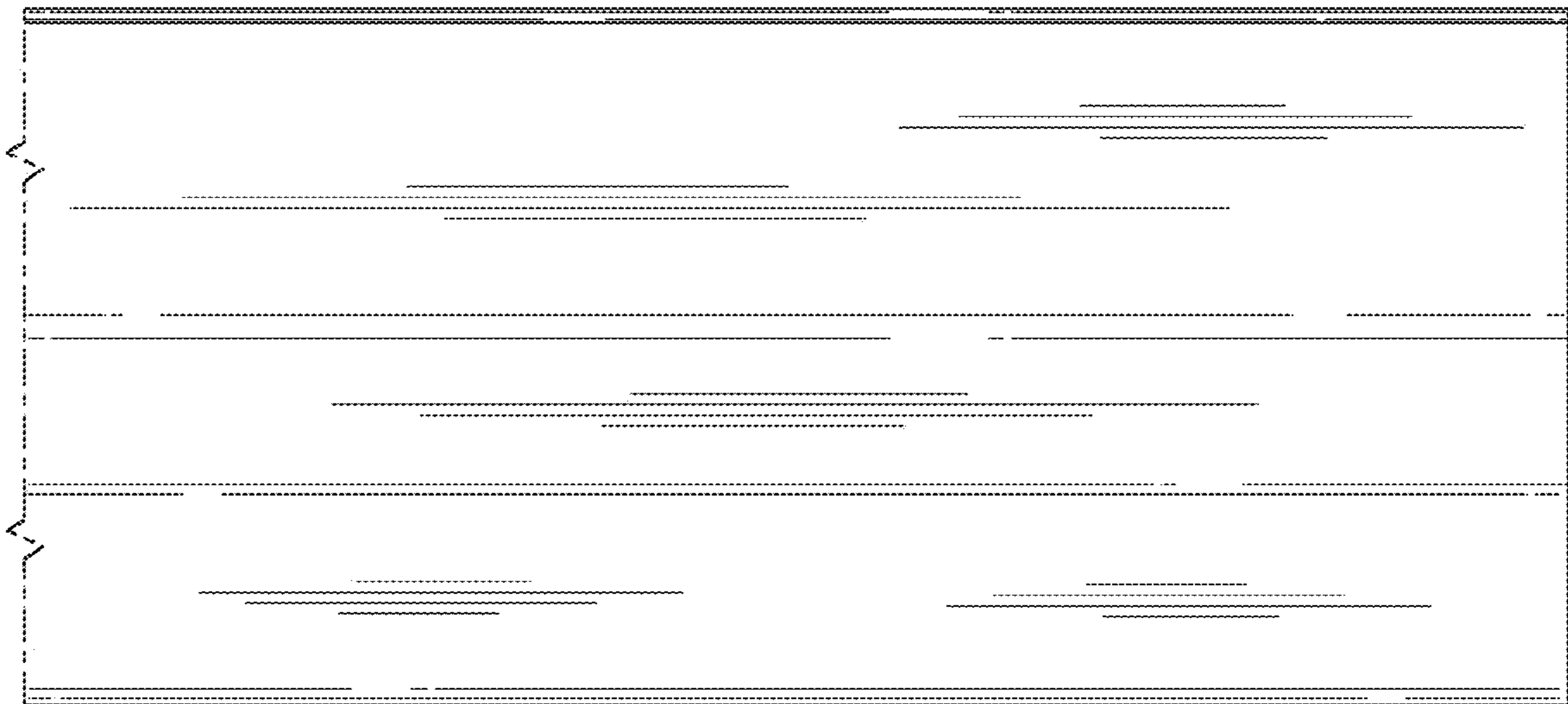

FIG. 4



FIG. 5



FIG. 6

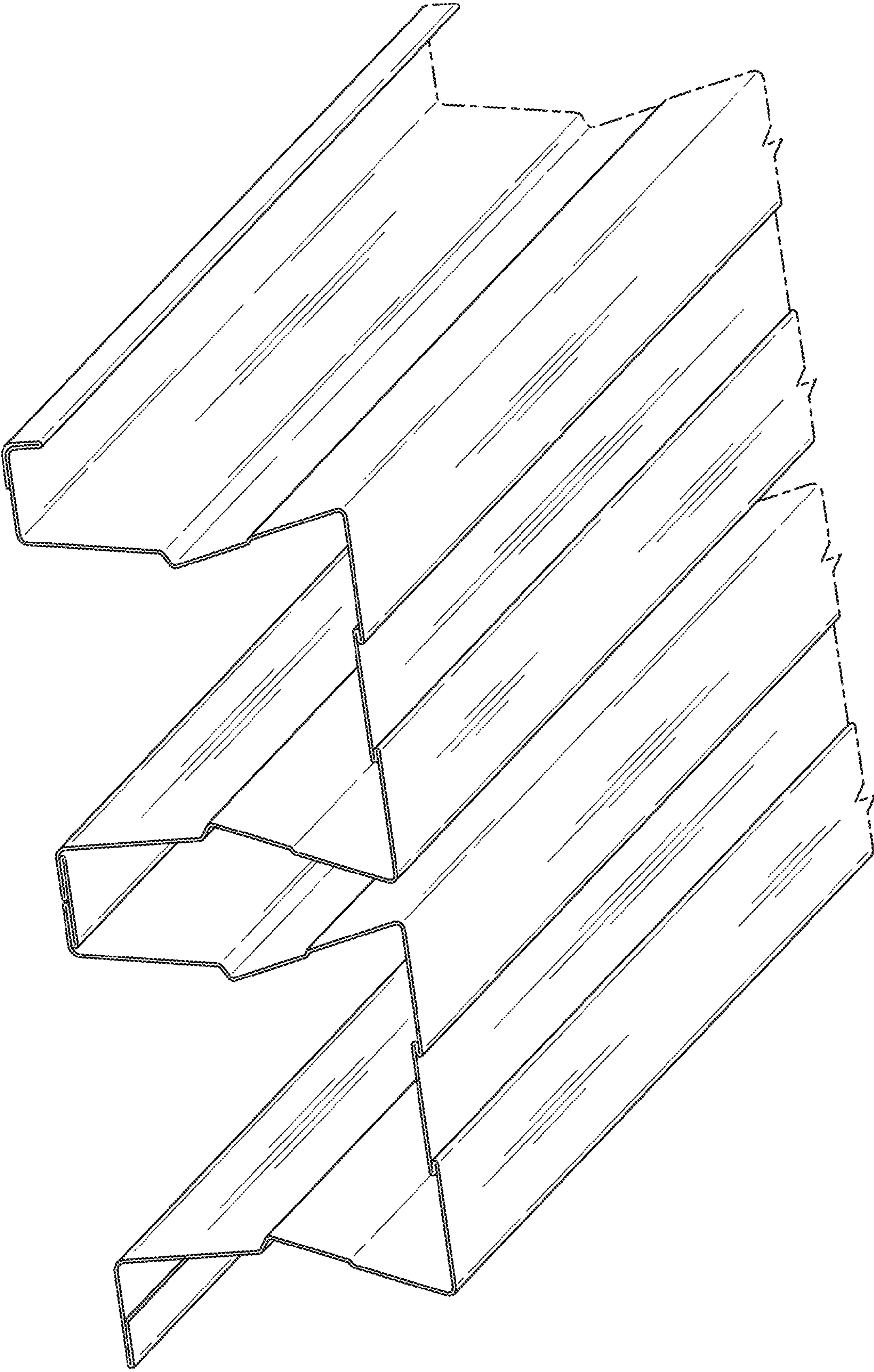

FIG. 7

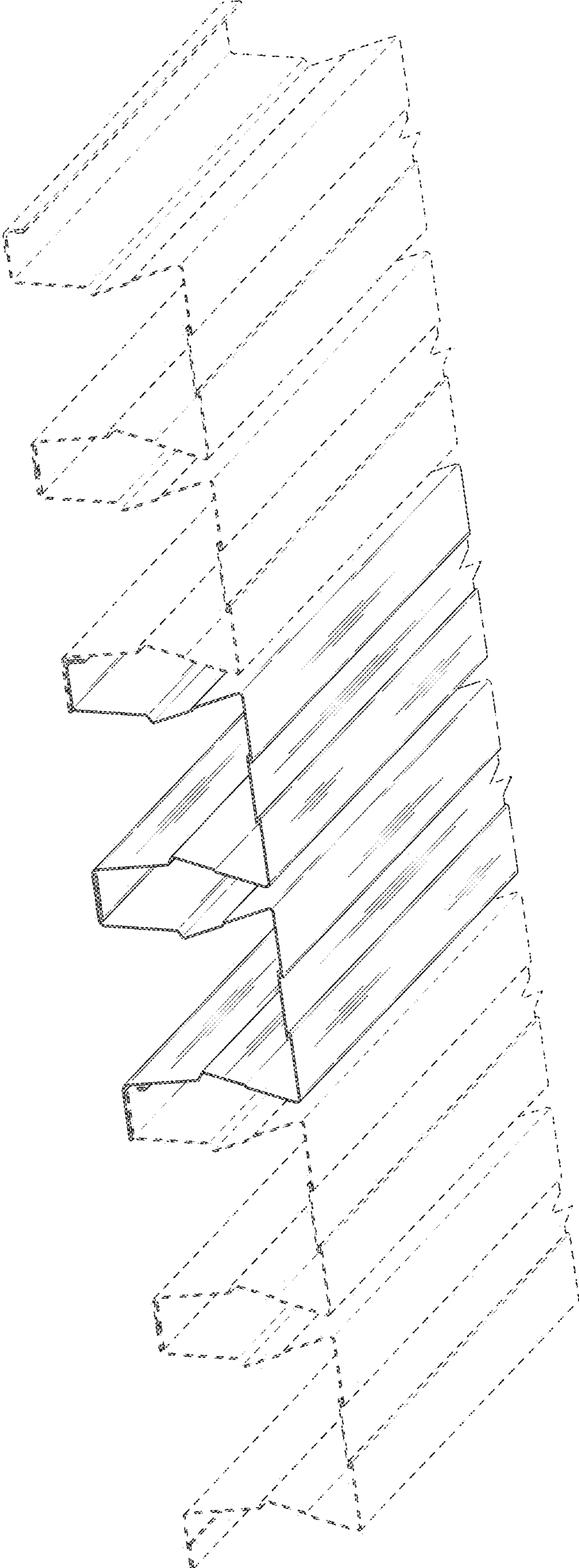

FIG. 8

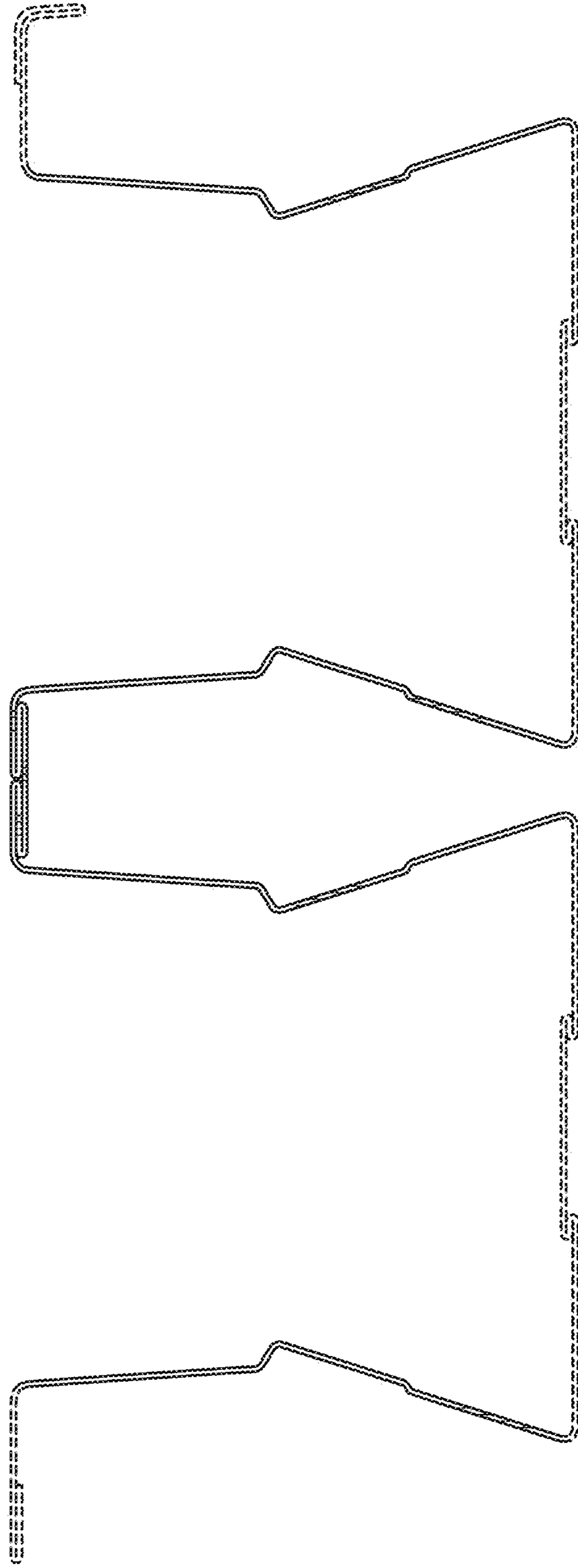

FIG. 9

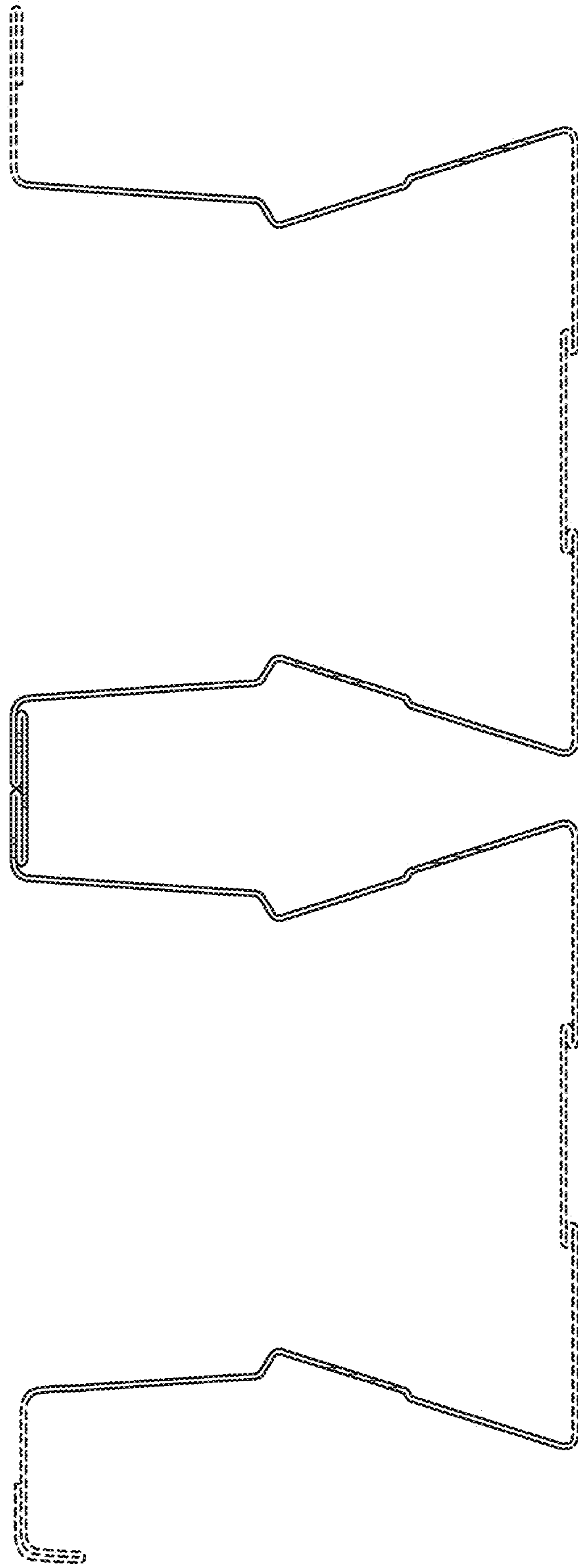

FIG. 10

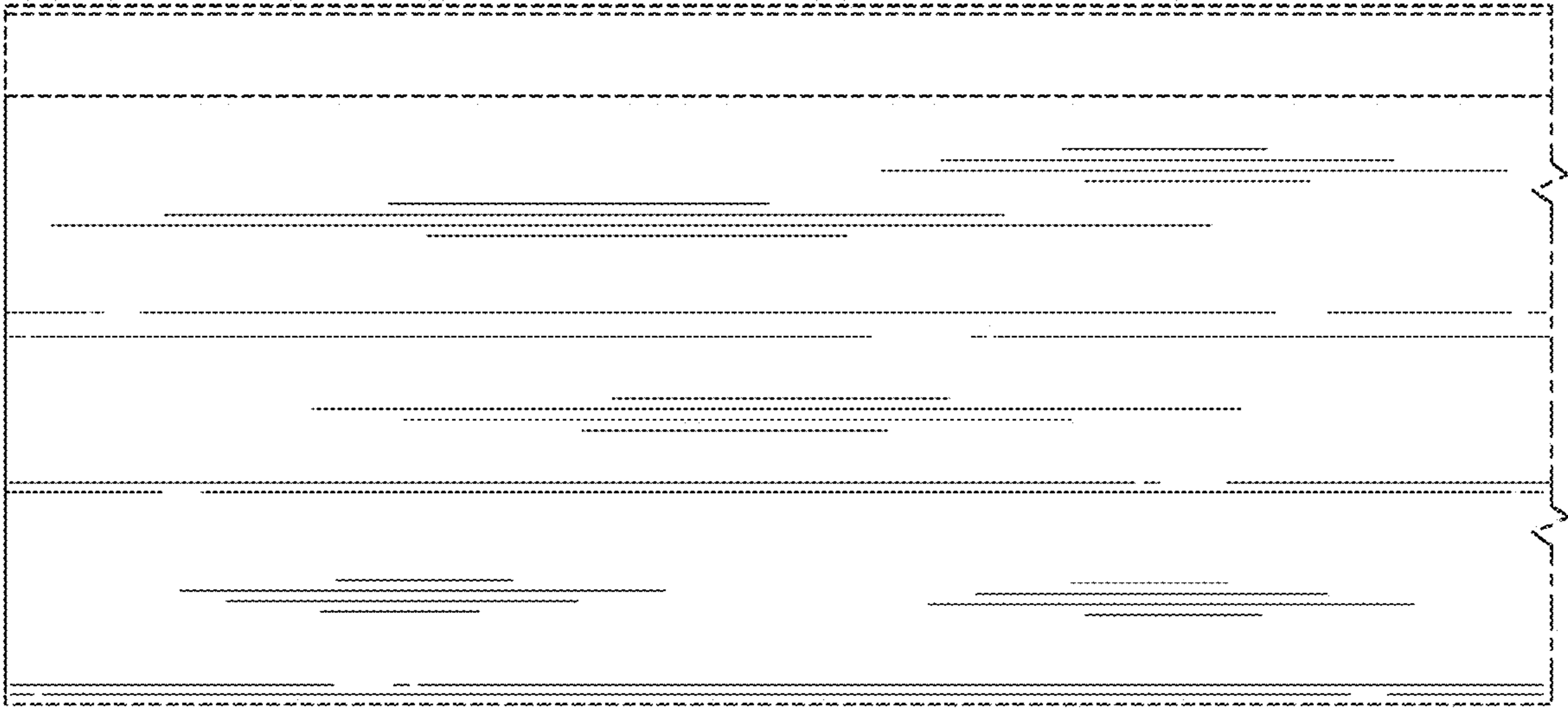

FIG. 11

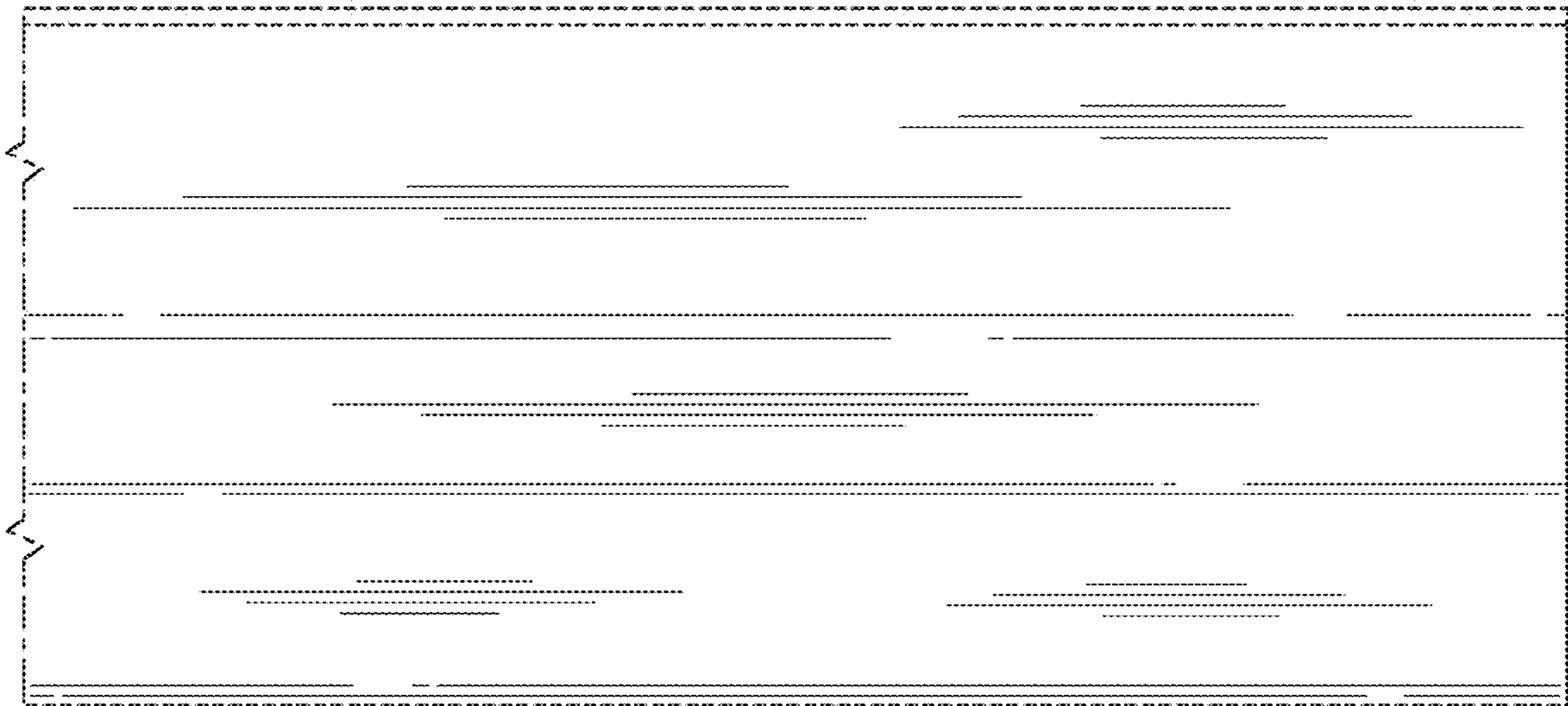

FIG. 12

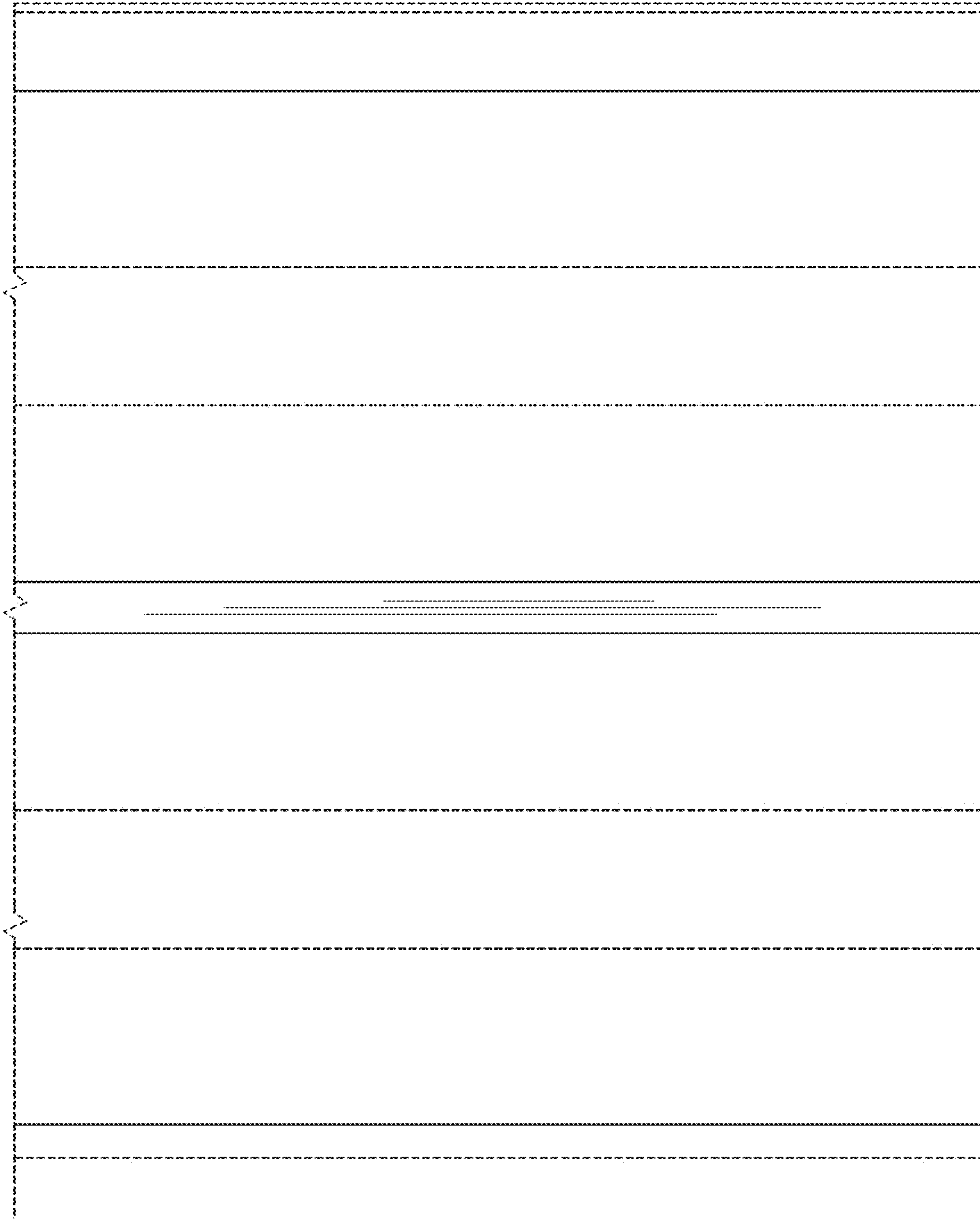

FIG. 13

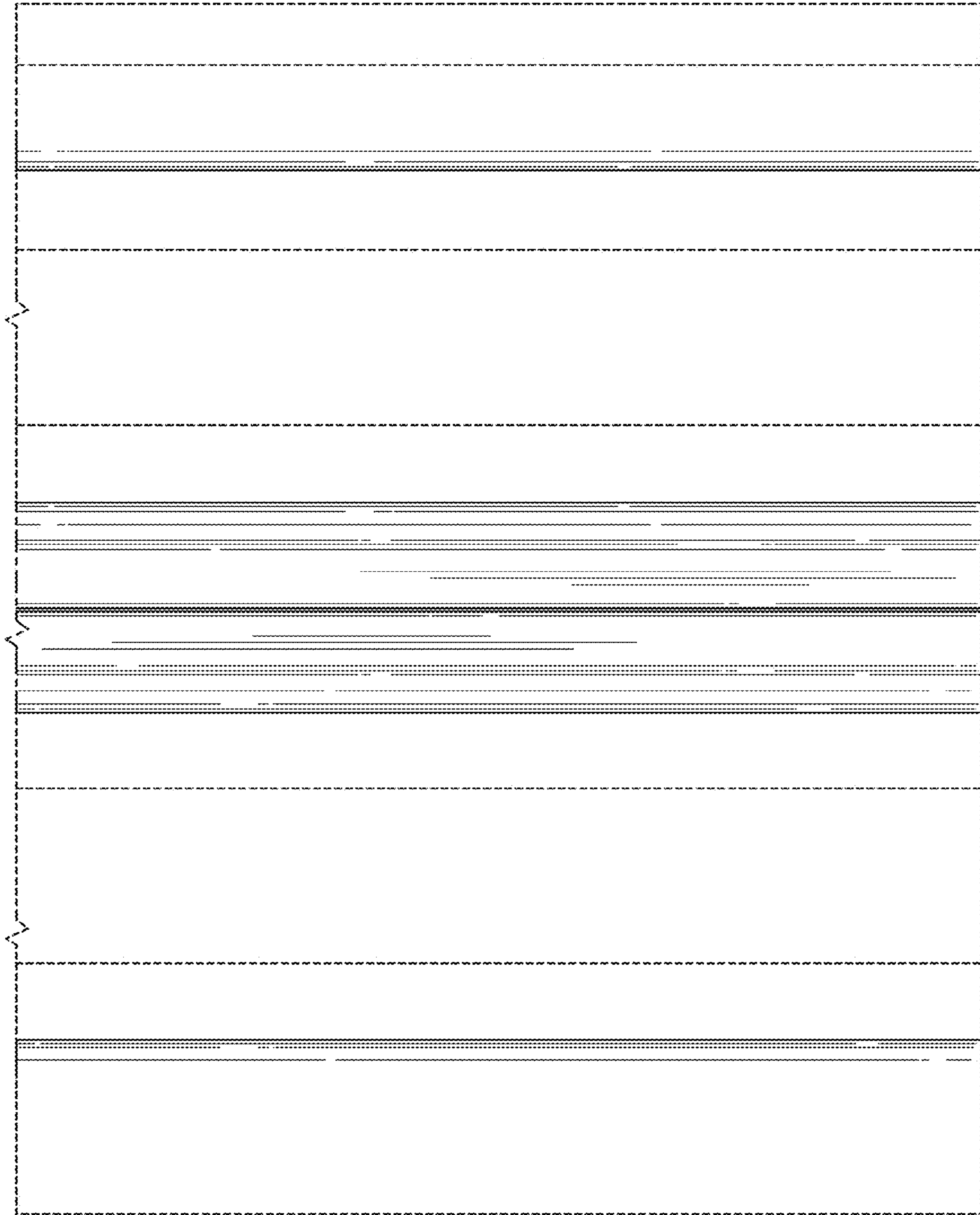

FIG. 14

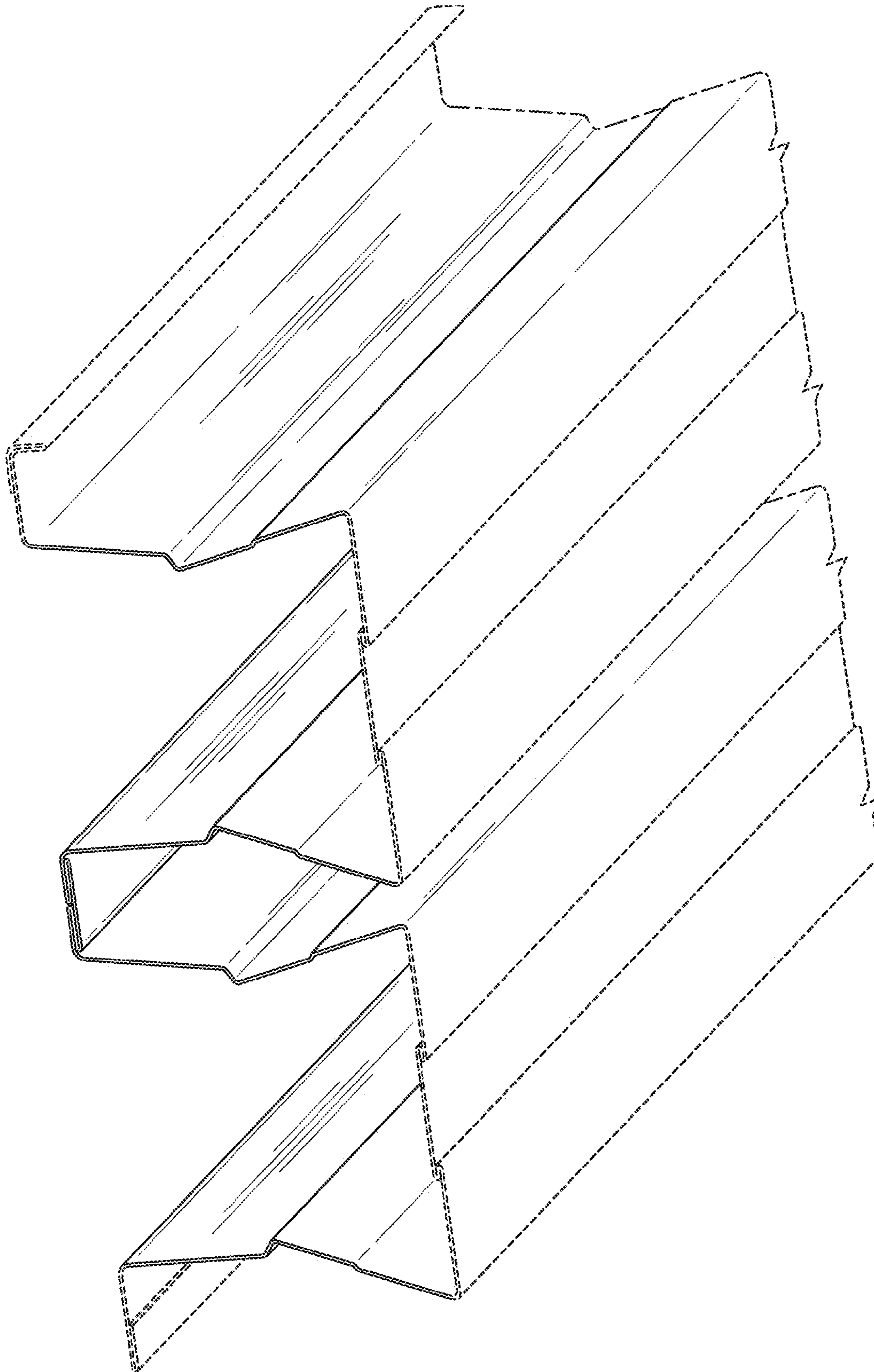

FIG. 15

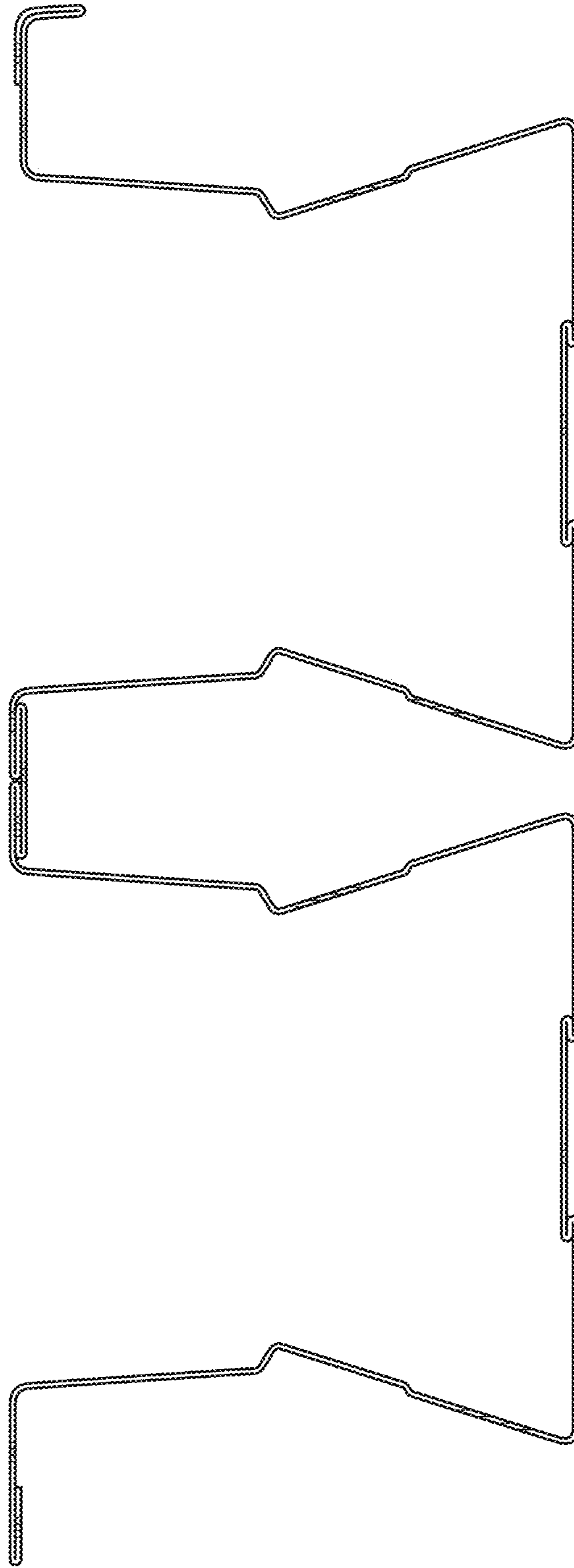

FIG. 16

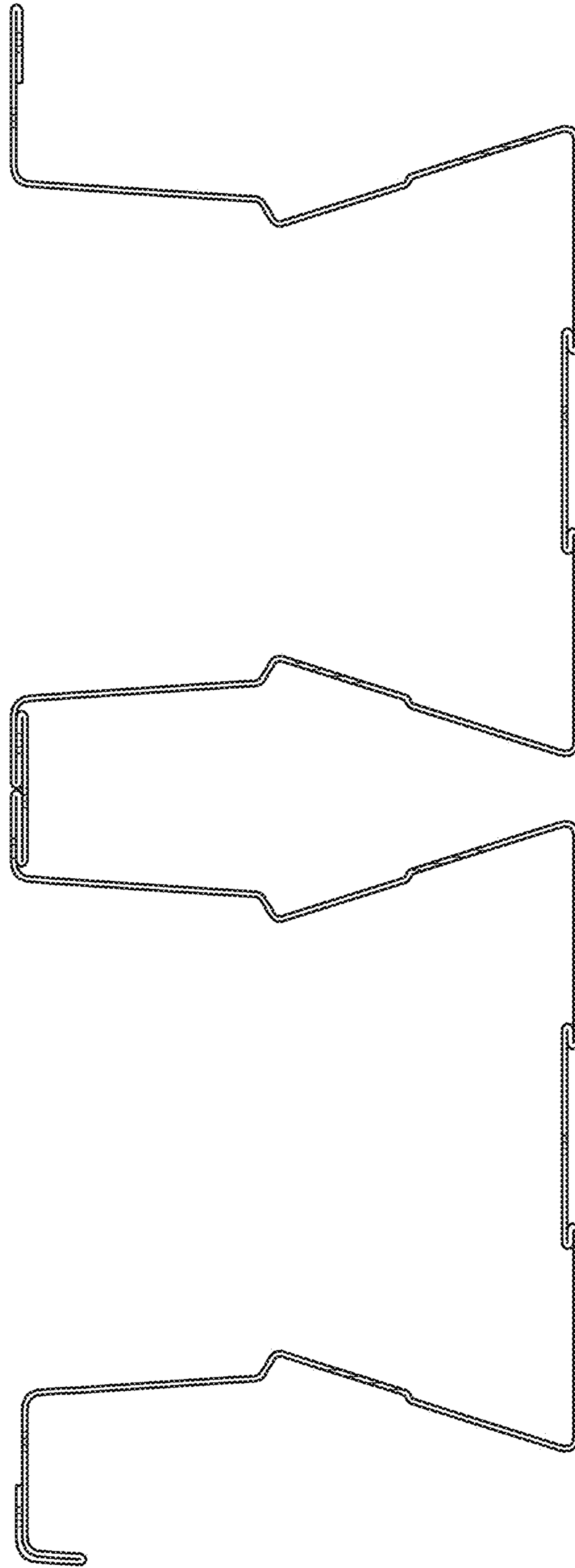

FIG. 17

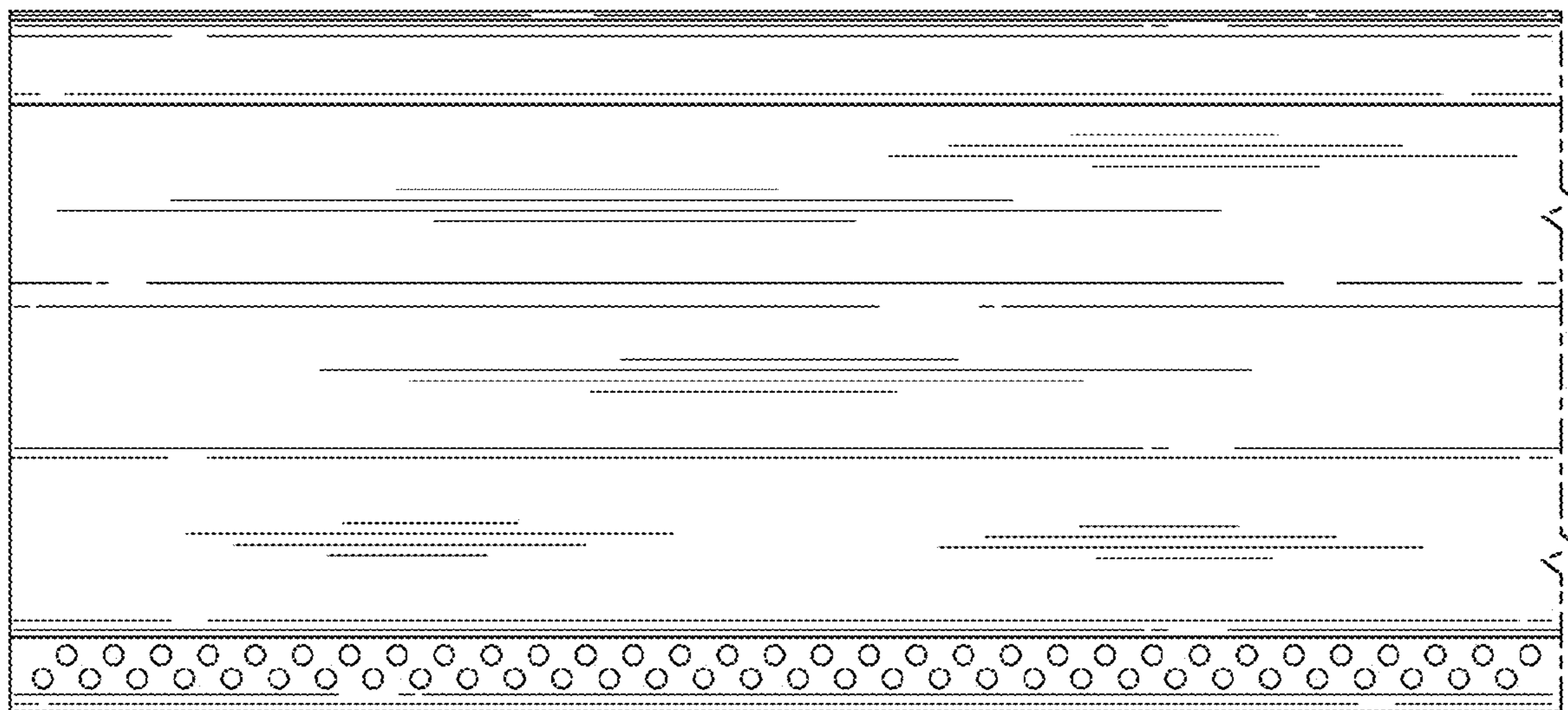

FIG. 18

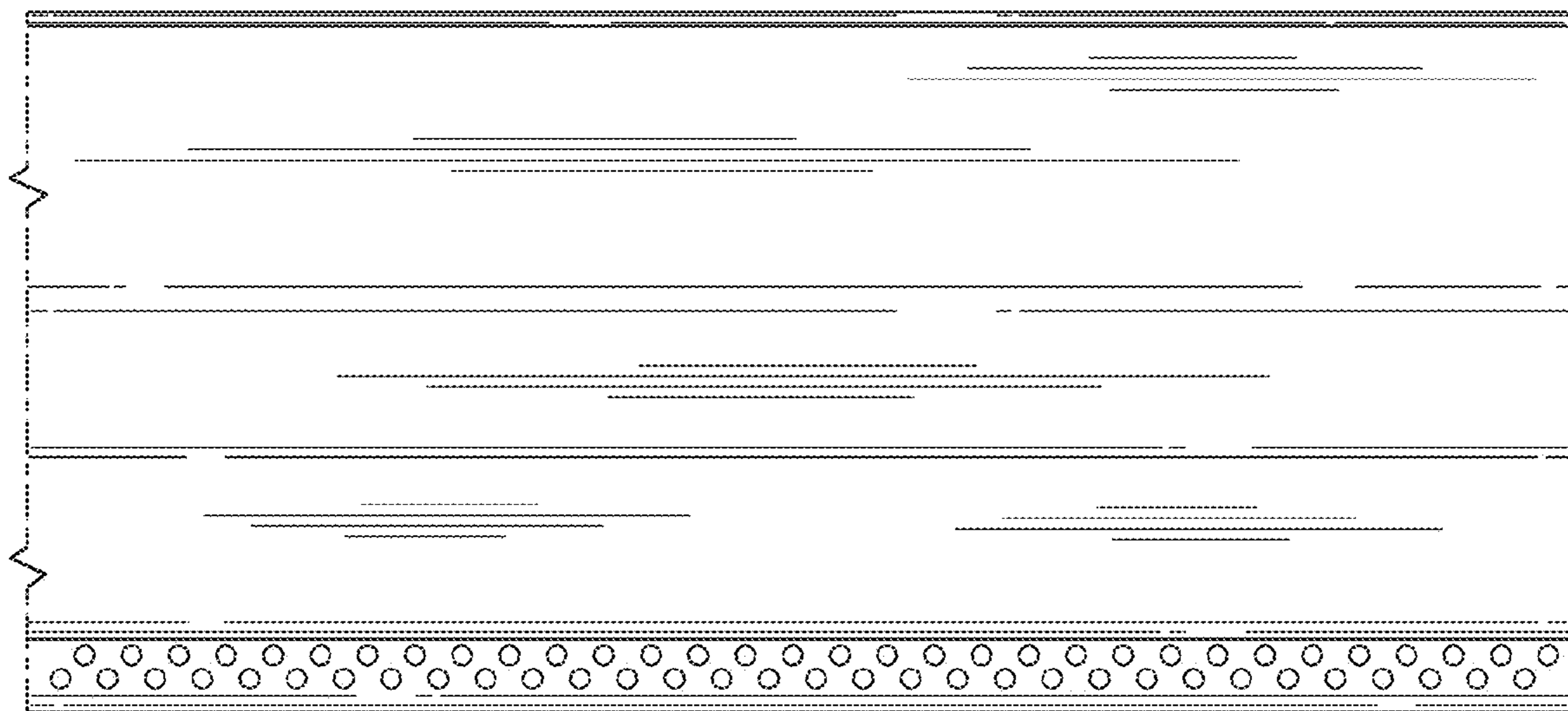

FIG. 19

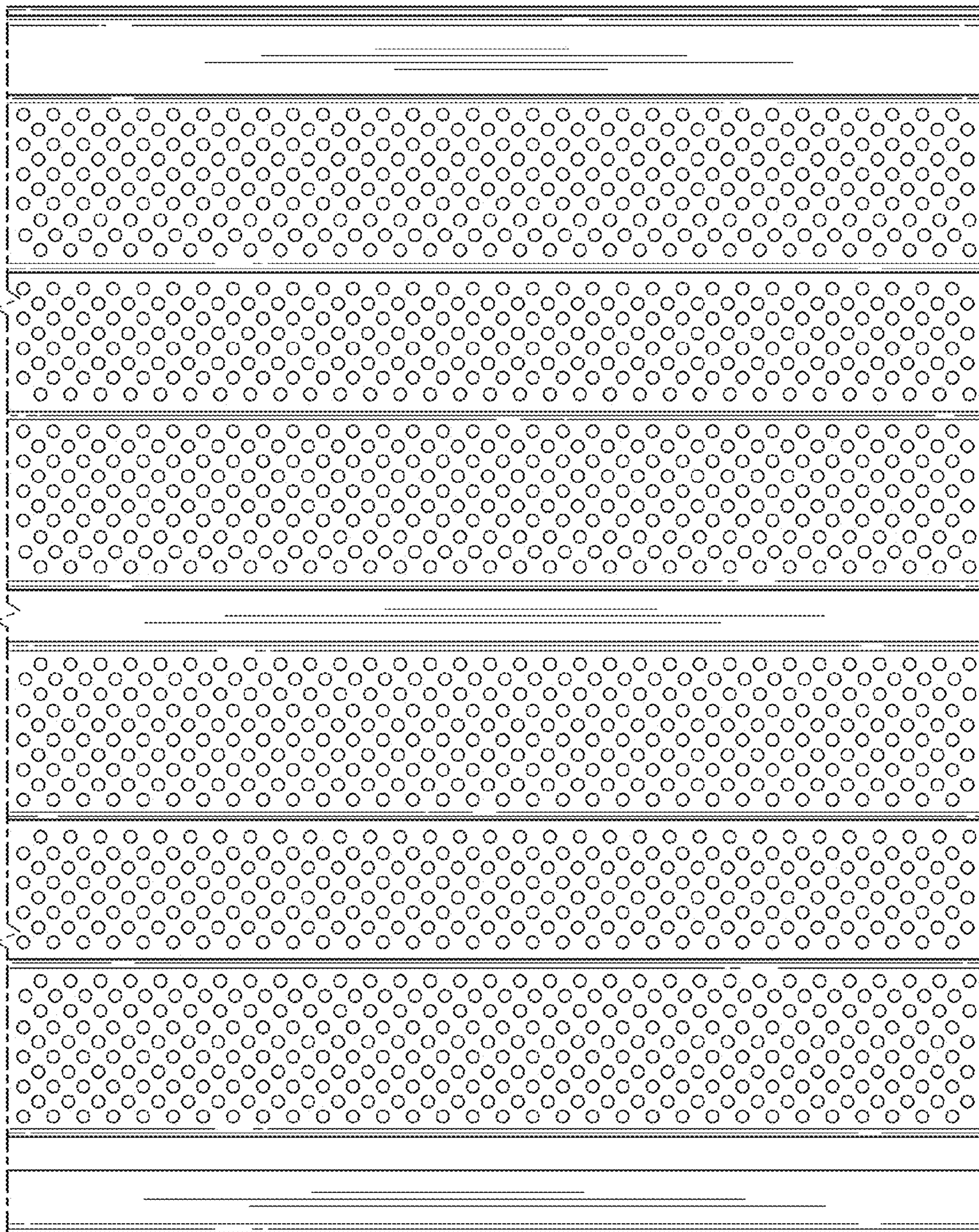

FIG. 20

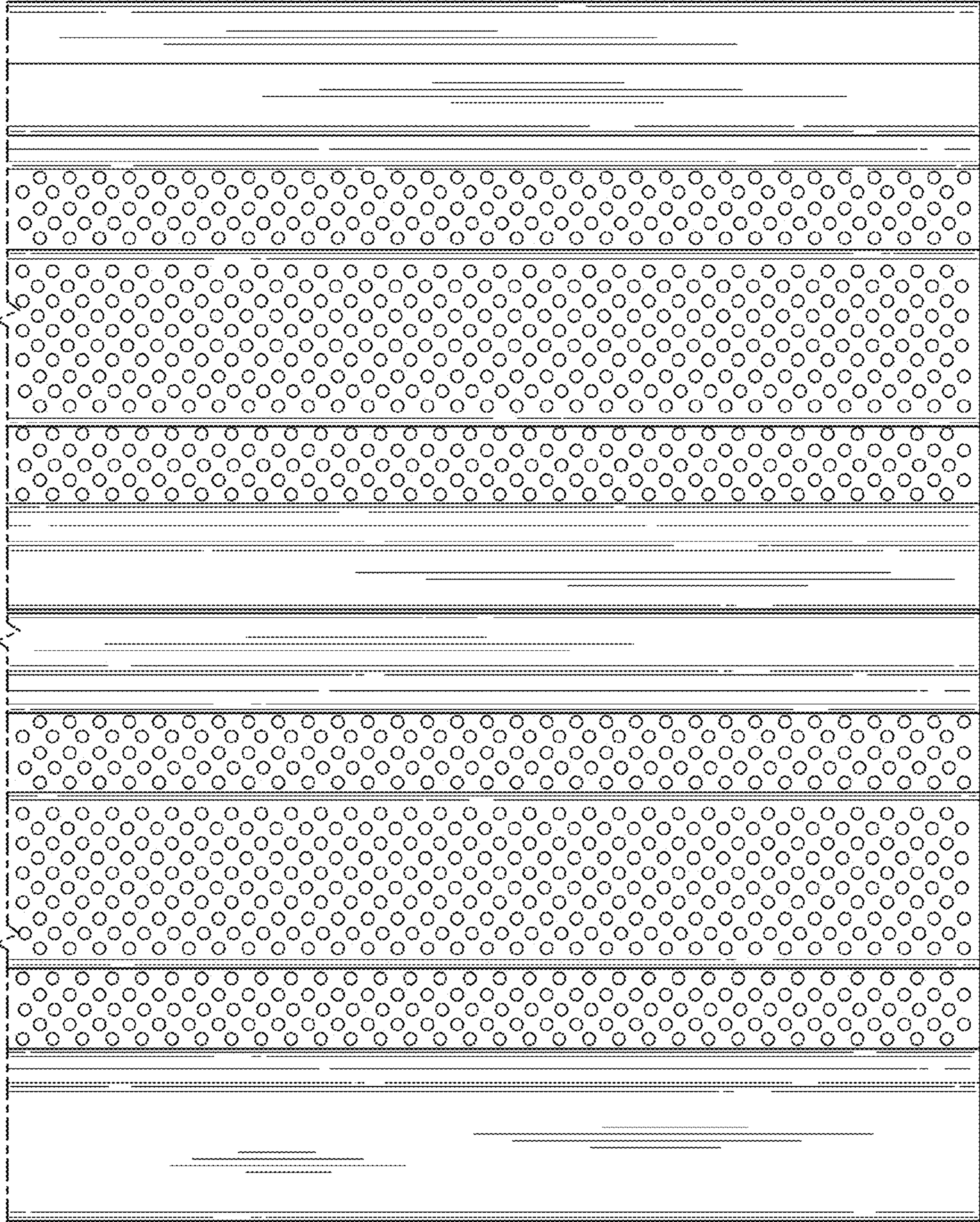

FIG. 21

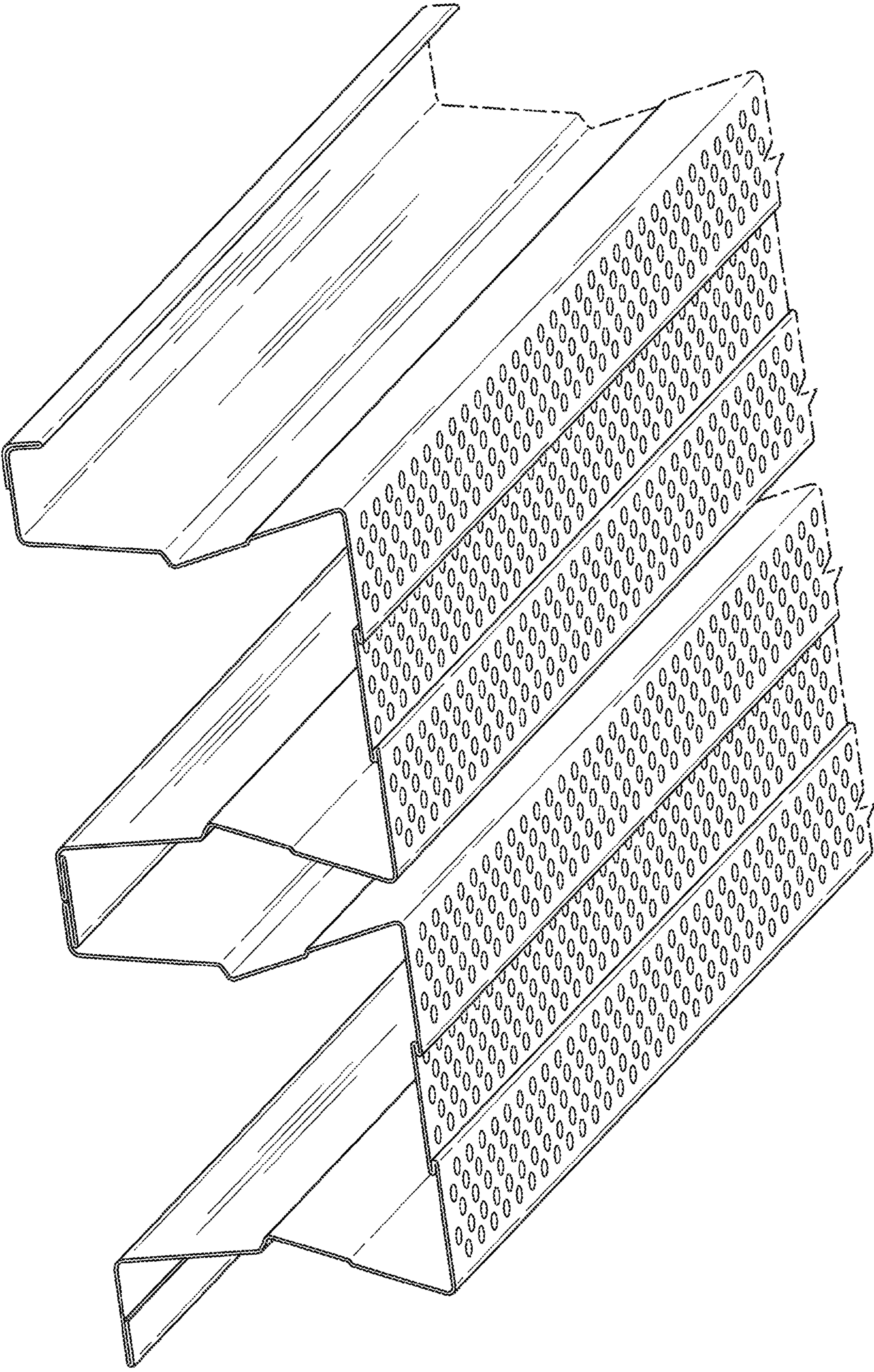

FIG. 22

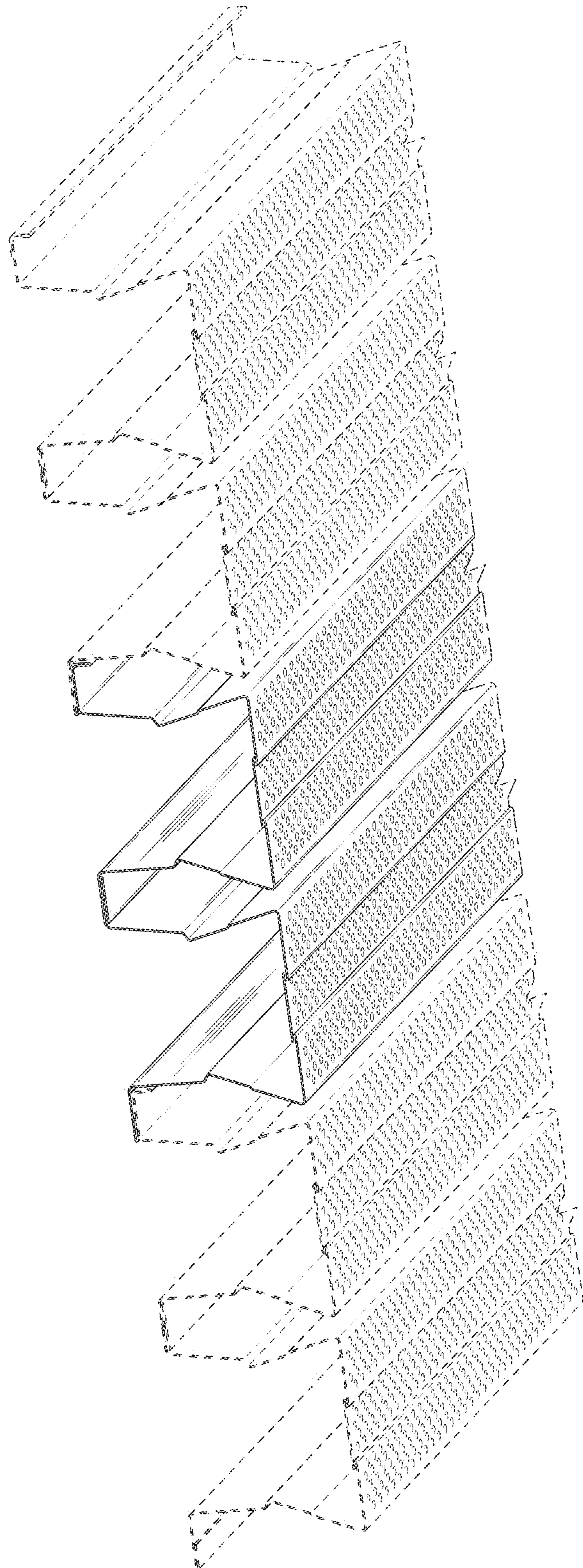

FIG. 23