



US00D950096S

(12) **United States Design Patent**
Anderton et al.

(10) **Patent No.:** **US D950,096 S**
(45) **Date of Patent:** **** Apr. 26, 2022**

- (54) **ADULT TOY**
- (71) Applicant: **EIS GmbH**, Bielefeld (DE)
- (72) Inventors: **Alexander Anderton**, Hamburg (DE);
Paul Fally, Hamburg (DE); **Alex Dumler**, Hamburg (DE); **Mariana Rosa Yzusqui Burkard**, Hamburg (DE)
- (73) Assignee: **EIS GmbH**, Bielefeld (DE)
- (**) Term: **15 Years**
- (21) Appl. No.: **29/781,699**
- (22) Filed: **Apr. 30, 2021**

- D414,582 S 9/1999 Hwang
- D448,380 S 9/2001 Sheehan et al.
- D623,294 S 9/2010 Rhoades et al.
- D636,888 S * 4/2011 Nikitzuk D24/215
- D648,862 S * 11/2011 Yen D24/215
- D666,303 S 8/2012 Ding et al.
- D706,439 S 6/2014 Hahr et al.
- D726,926 S 4/2015 Matsushita
- D735,870 S 8/2015 Ban
- D794,170 S * 8/2017 Lopez D23/332
- D811,931 S * 3/2018 Yu D11/131.1
- D819,222 S * 5/2018 Nelson D24/215

(Continued)

Related U.S. Application Data

- (62) Division of application No. 35/509,048, filed on Oct. 7, 2019 (U.S. filing date under 35 U.S.C. 384), and having an international filing date of Oct. 7, 2019, now Pat. No. Des. 927,721.
- (51) **LOC (13) Cl.** **28-03**
- (52) **U.S. Cl.**
USPC **D24/215**
- (58) **Field of Classification Search**
USPC D24/133, 188, 200, 211–215; D28/91.1;
D9/723, 726, 727; D4/100; D14/417;
D23/366
CPC A61H 2201/0153; A61H 7/007; A61H
15/0085; A61H 2015/0014; A61H 7/005;
A61H 19/32; A61B 17/1325; A61F 7/00
See application file for complete search history.

References Cited

U.S. PATENT DOCUMENTS

- D358,654 S 5/1995 Smith
- D382,959 S 8/1997 Arpe
- D410,638 S 6/1999 Sheehan et al.

OTHER PUBLICATIONS

satisfyer.com, Sexy Secret, undated online product pages, retrieved May 21, 2021 from <https://us.satisfyer.com/us/products/clit-vibrators/lay-on-vibrators/sexy-secret/>, 2021.

Primary Examiner — Calvin E Vansant

(74) *Attorney, Agent, or Firm* — Mueting Raasch Group

CLAIM

We claim the ornamental design for an adult toy, as shown and described.

DESCRIPTION

The patent or application file contains at least one drawing executed in color. Copies of this patent or patent application publication with color drawing(s) will be provided by the Office upon request and payment of the necessary fee.

- FIG. 1 is a front view of an adult toy;
- FIG. 2 is a bottom view thereof;
- FIG. 3 is a side view thereof;
- FIG. 4 is a back view thereof;
- FIG. 5 is a back perspective view thereof;
- FIG. 6 is a front perspective view thereof; and,
- FIG. 7 is a top view thereof.

1 Claim, 7 Drawing Sheets
(7 of 7 Drawing Sheet(s) Filed in Color)

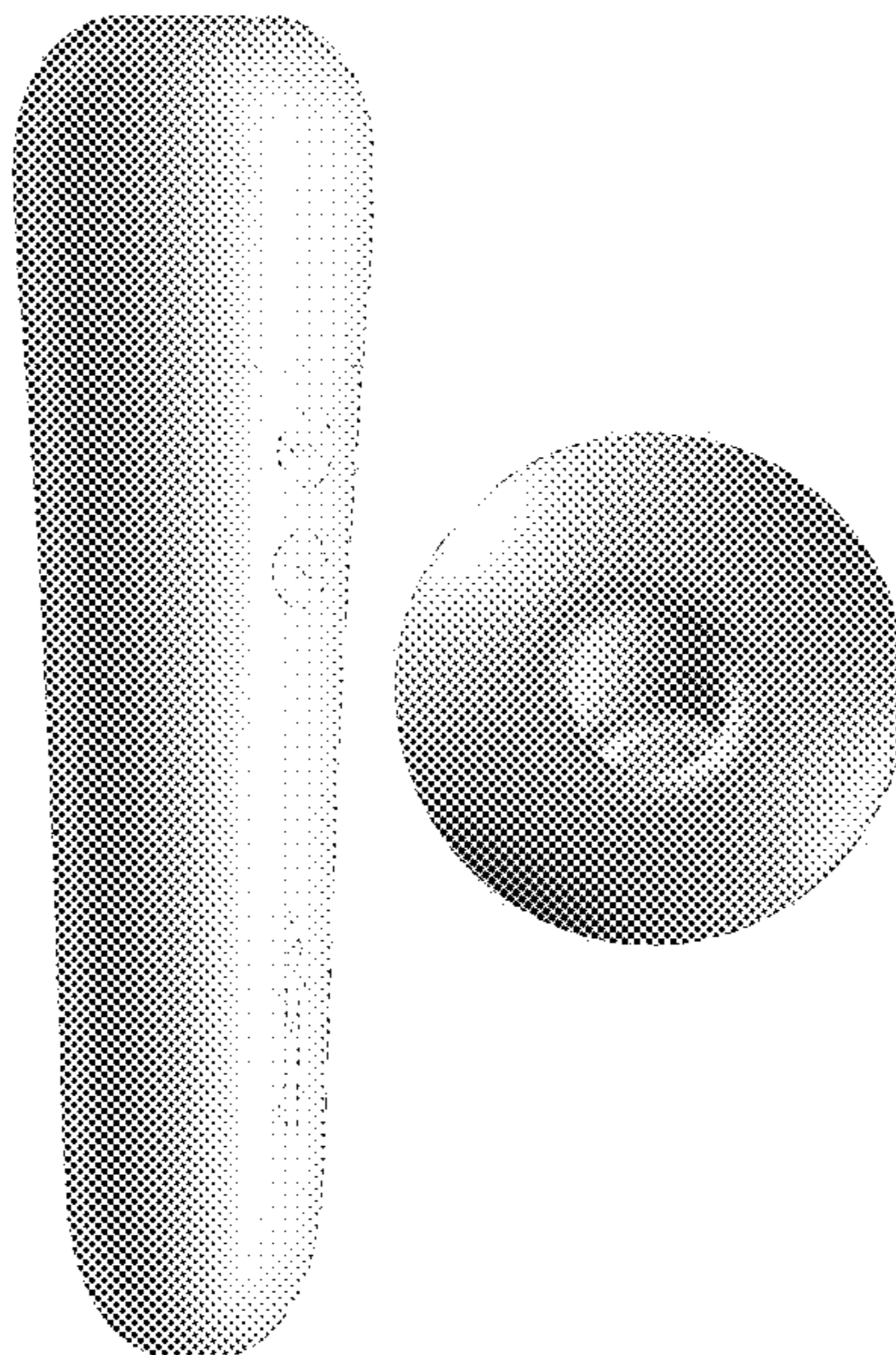

(56)

References Cited

U.S. PATENT DOCUMENTS

D828,527 S * 9/2018 Xu D23/356
D836,792 S * 12/2018 Fuhner D24/215
D852,318 S * 6/2019 Lin D23/207
D868,989 S * 12/2019 Marshall D24/215
D869,675 S 12/2019 Hitscherich et al.
D870,903 S 12/2019 Weisman
D878,528 S * 3/2020 Fu A61H 19/44
D23/356
D880,674 S * 4/2020 Gobber D23/366
D886,384 S 6/2020 Khubani et al.
D888,265 S * 6/2020 Dumler D24/215
D890,944 S * 7/2020 Tsang D24/215
D899,619 S * 10/2020 Meissner D24/215
D901,707 S * 11/2020 Meissner D24/215
D902,425 S * 11/2020 Cornaro D24/215
D926,305 S * 7/2021 Lee D24/215
2012/0136205 A1 * 5/2012 Aguilera Galeote .. A61H 19/44
600/38
2020/0281808 A1 9/2020 Kirsten et al.

* cited by examiner

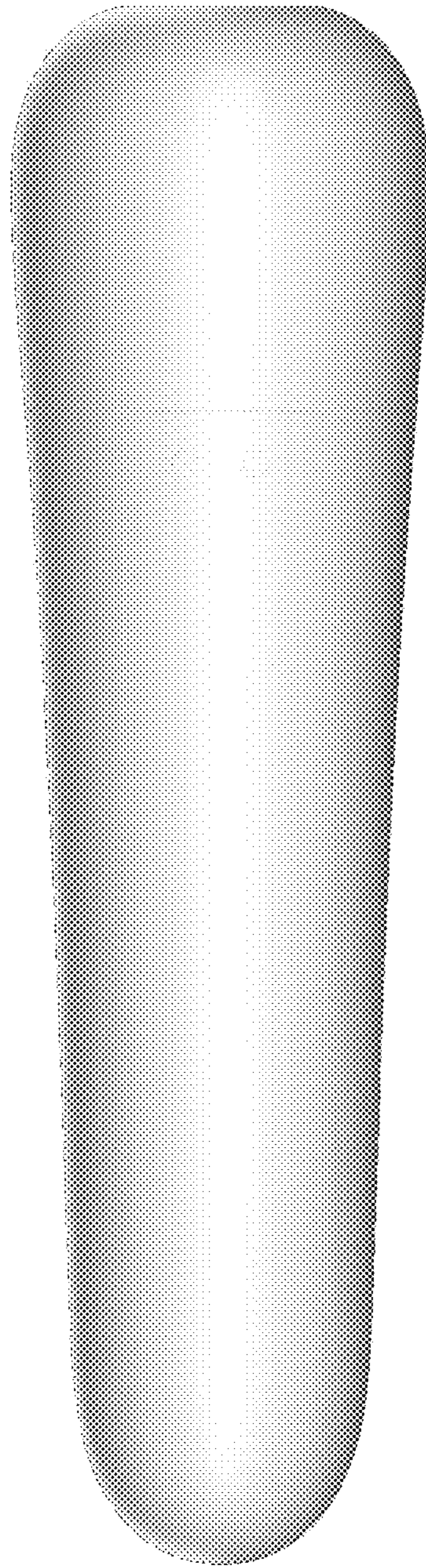

FIG. 1

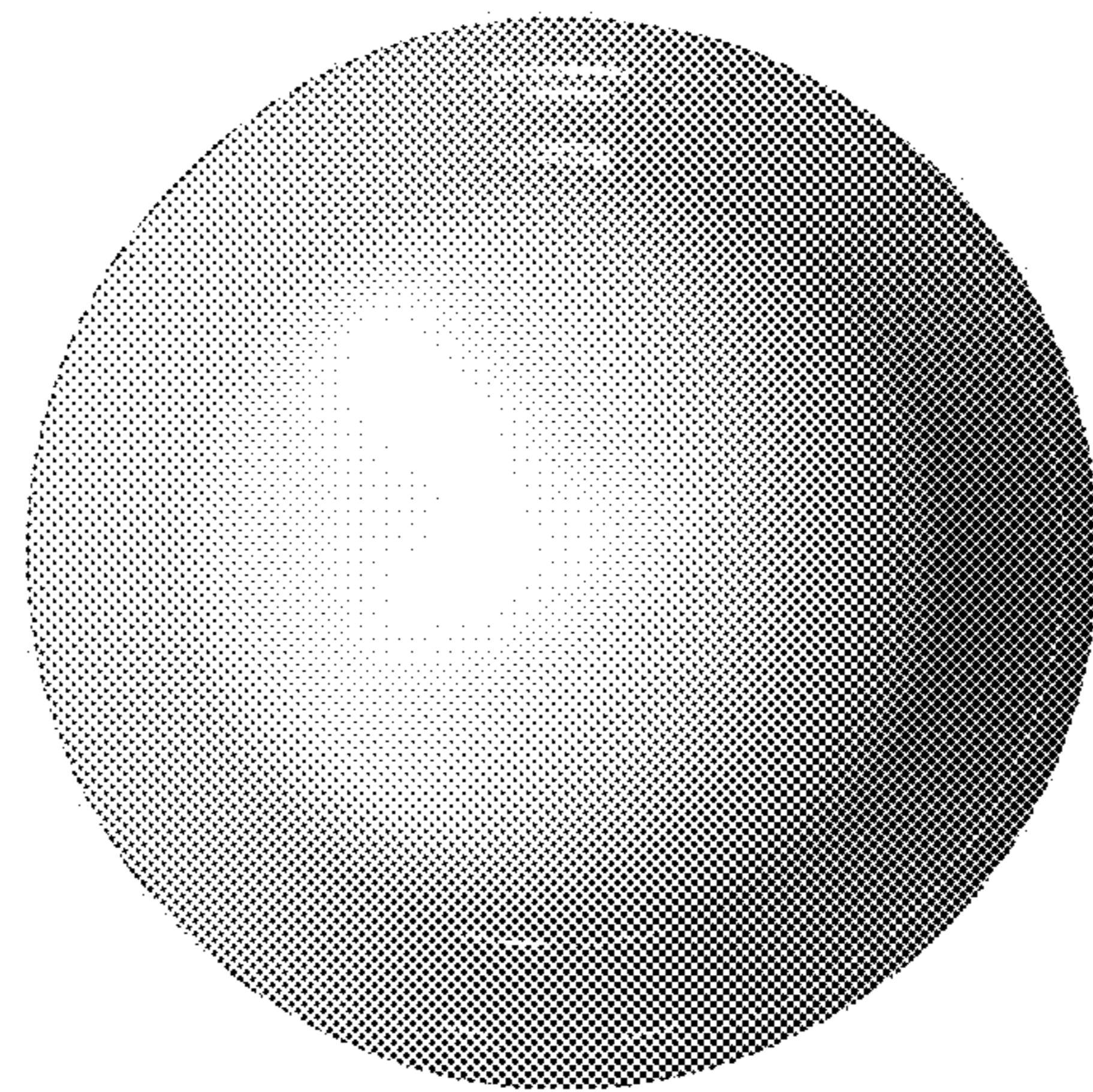

FIG. 2

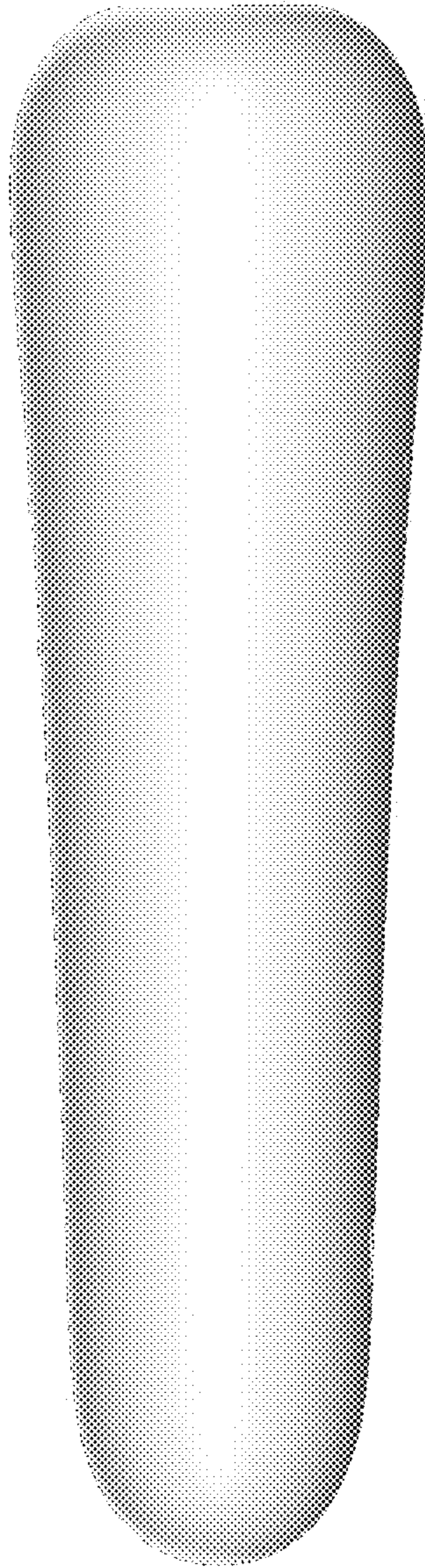

FIG. 3

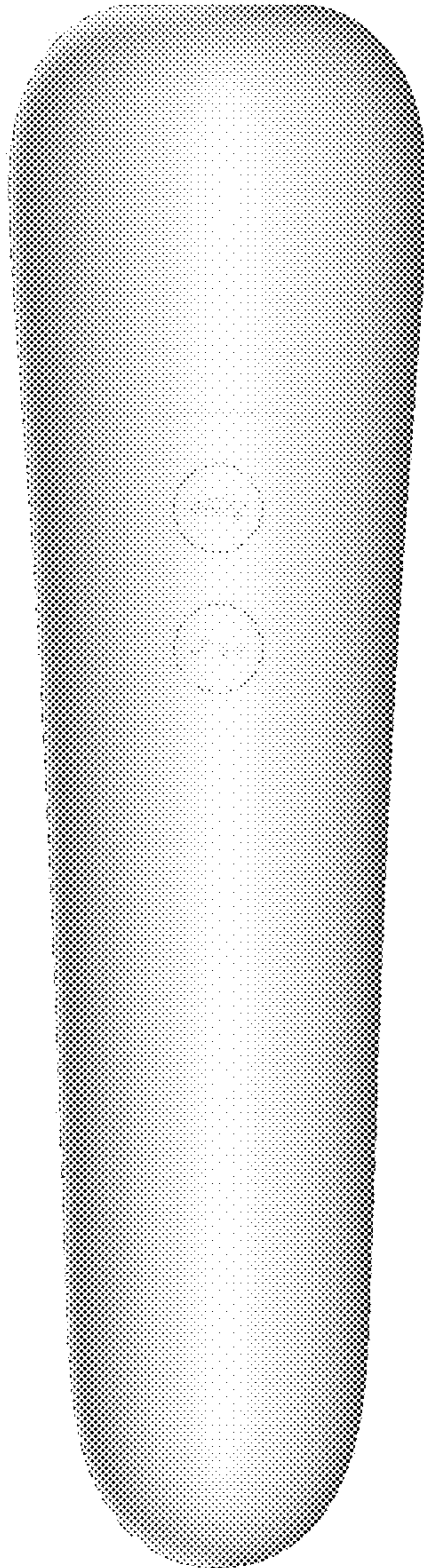

FIG. 4

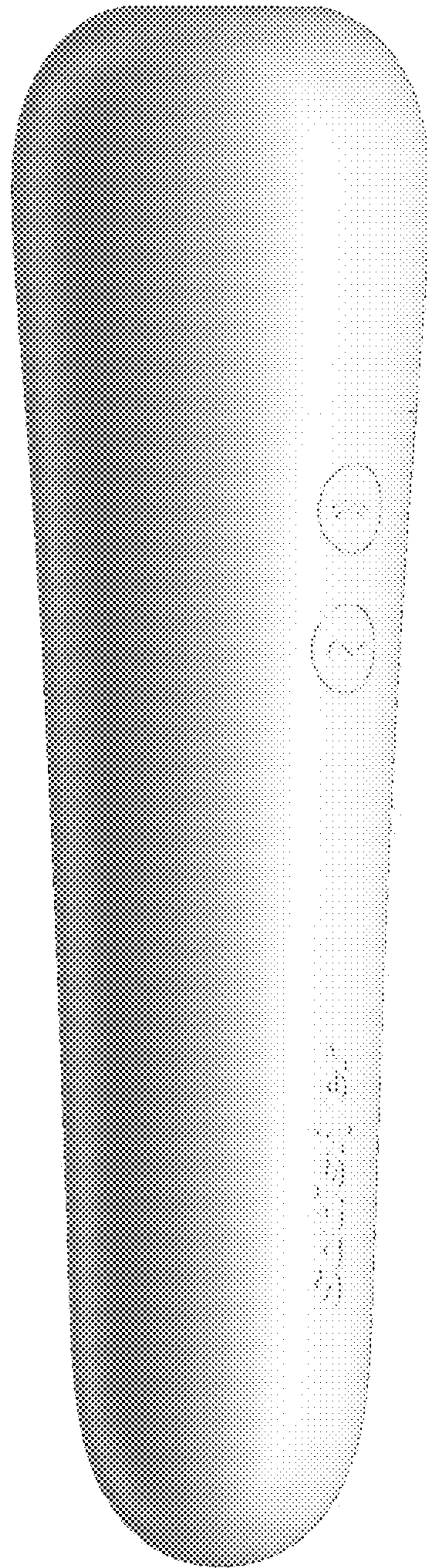

FIG. 5

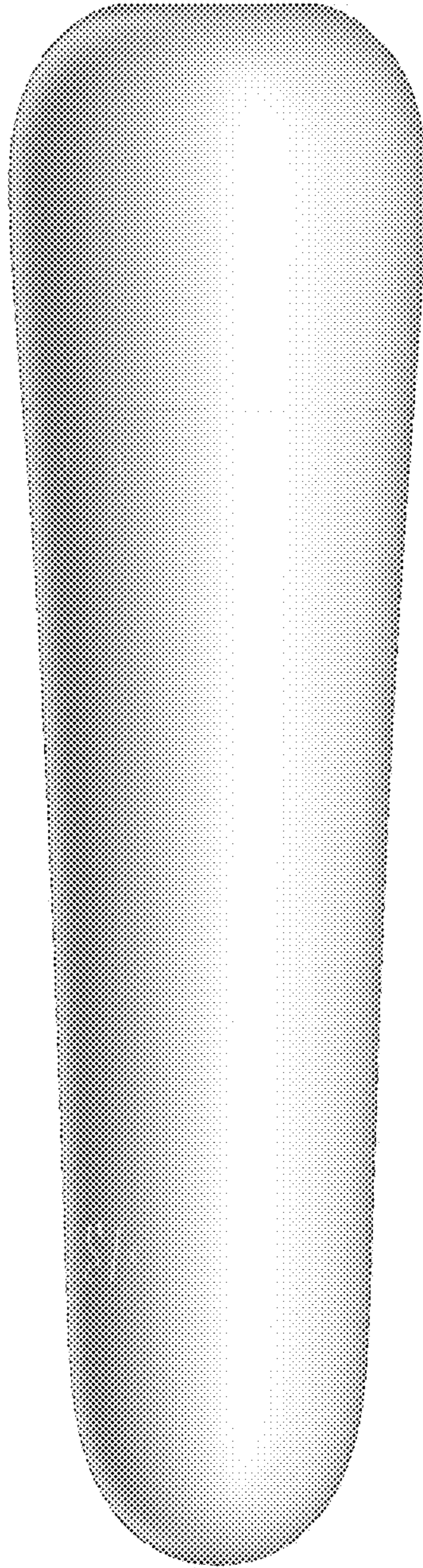

FIG. 6

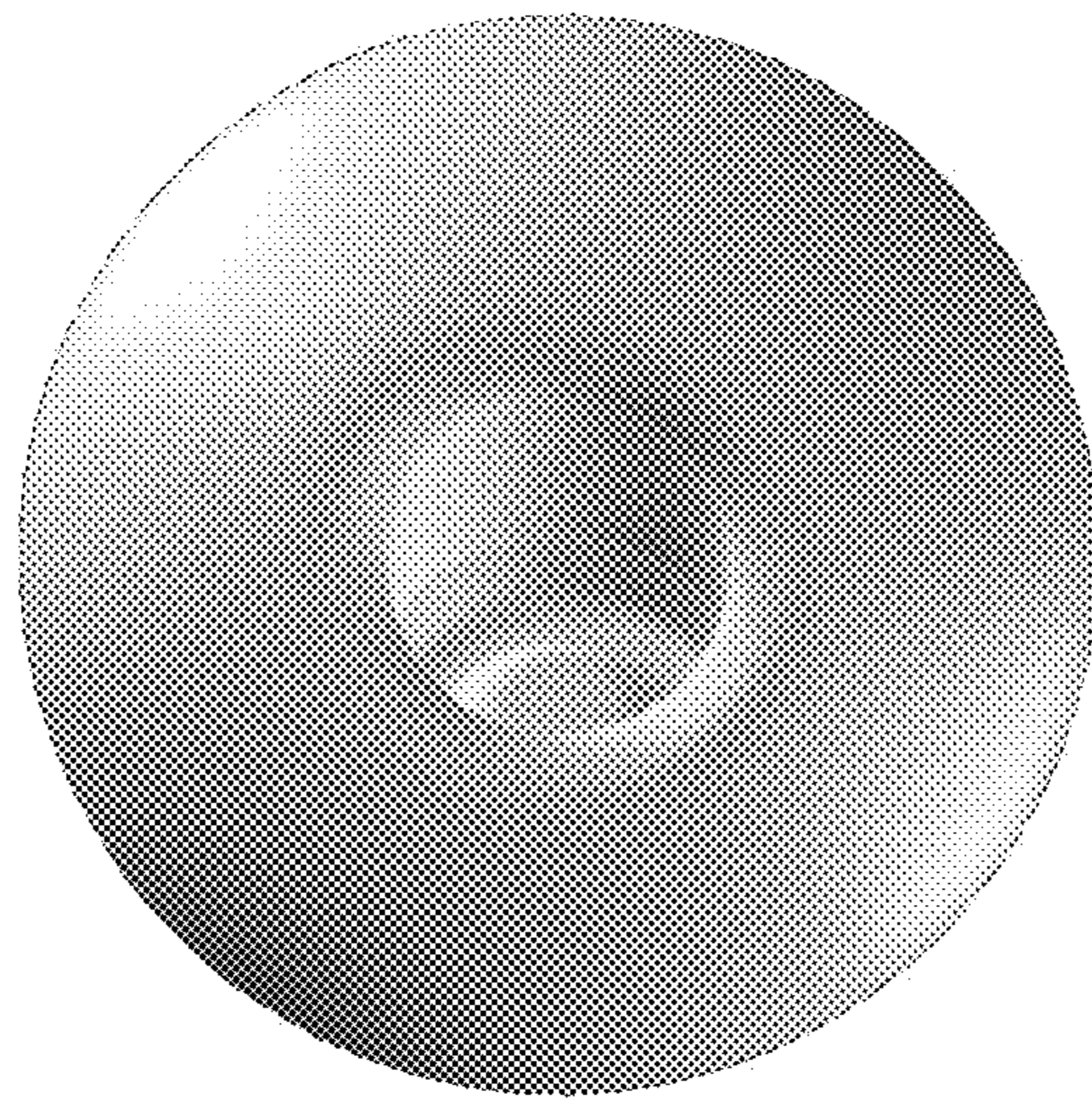

FIG. 7