



US00D949975S

(12) **United States Design Patent**
Komagata et al.

(10) **Patent No.:** **US D949,975 S**
(45) **Date of Patent:** **** Apr. 26, 2022**

(54) **GAME MACHINE**

(56) **References Cited**

(71) Applicant: **Marvelous Inc.**, Tokyo (JP)

U.S. PATENT DOCUMENTS

(72) Inventors: **Naoki Komagata**, Tokyo (JP); **Shingo Dote**, Tokyo (JP)

D366,304	S	*	1/1996	Lewis	A63F 9/30
						D21/811
5,549,372	A	*	8/1996	Lewis	A63F 9/30
						273/448
5,711,530	A	*	1/1998	Lewis	A63F 9/30
						273/448
D619,649	S	*	7/2010	Chen	D18/57
D781,388	S	*	3/2017	Lu	D21/811
D794,716	S	*	8/2017	Wei	D21/325
D835,197	S	*	12/2018	Inuyama	D21/325
D884,075	S	*	5/2020	Fukazawa	D21/325

(**) Term: **15 Years**

(21) Appl. No.: **35/511,100**

(22) Filed: **Jul. 8, 2020**

(80) **Hague Agreement Data**

Int. Filing Date: **Jul. 8, 2020**
Int. Reg. No.: **DM/209338**
Int. Reg. Date: **Jul. 8, 2020**
Int. Reg. Pub. Date: **Jan. 8, 2021**

FOREIGN PATENT DOCUMENTS

JP 2004105477 A 4/2004

* cited by examiner

Primary Examiner — Joseph Kukella

(30) **Foreign Application Priority Data**

Feb. 5, 2020 (JP) 2020-002138

(51) **LOC (13) Cl.** **21-03**

(52) **U.S. Cl.**
USPC **D21/325**

(58) **Field of Classification Search**

USPC D21/324, 325, 333, 811
CPC A63F 9/00; A63F 9/30; A63F 13/08; A63F
13/90; A63F 2250/144; G07F 17/3253;
G07F 17/3297

See application file for complete search history.

(57) **CLAIM**

The ornamental design for a game machine, as shown and described.

DESCRIPTION

1. Game machine **1.1** : Front **1.2** : Back **1.3** : Left **1.4** : Top **1.5** : Bottom **1.6** : Perspective **1.7** : Right

1 Claim, 7 Drawing Sheets

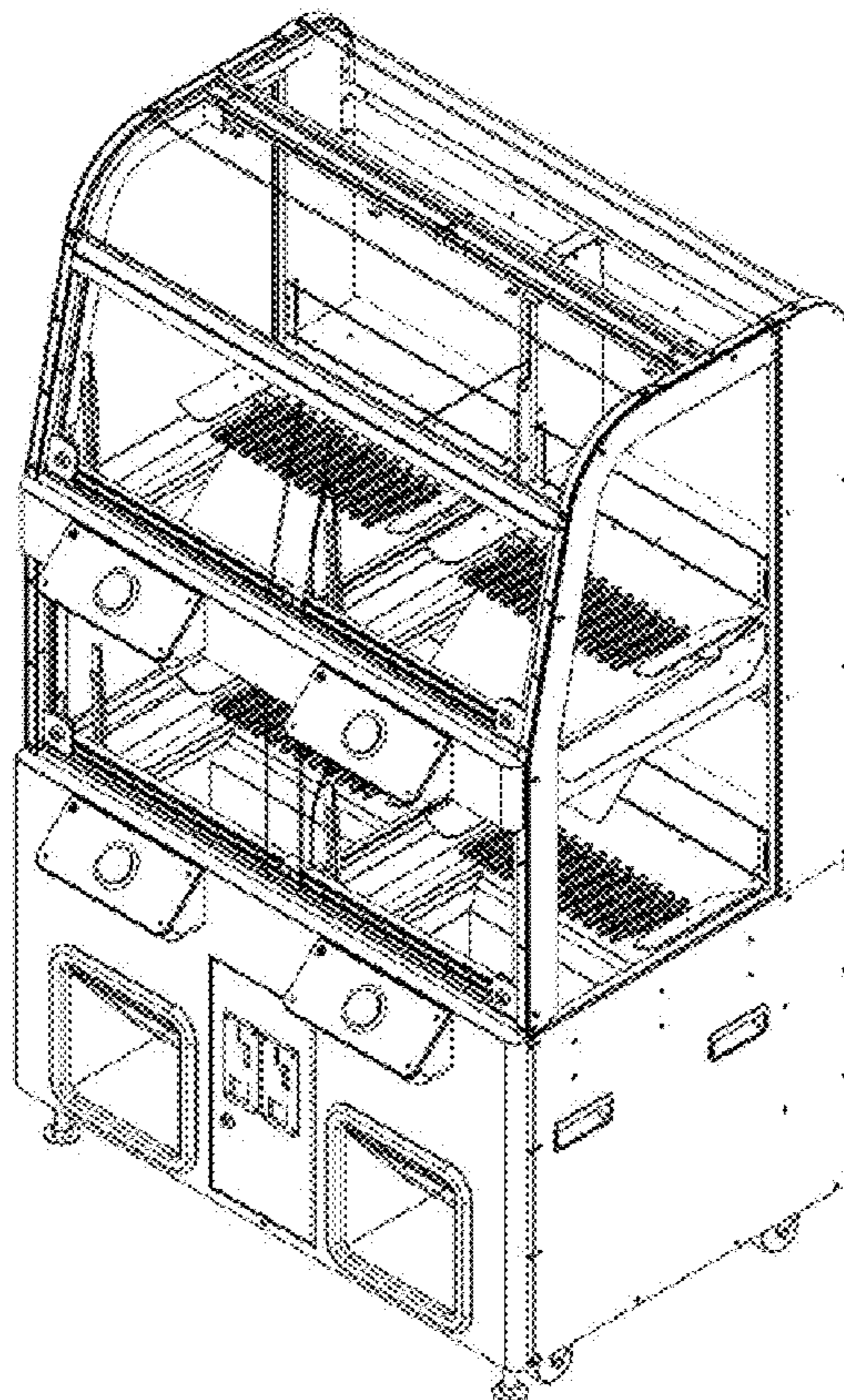

1.1

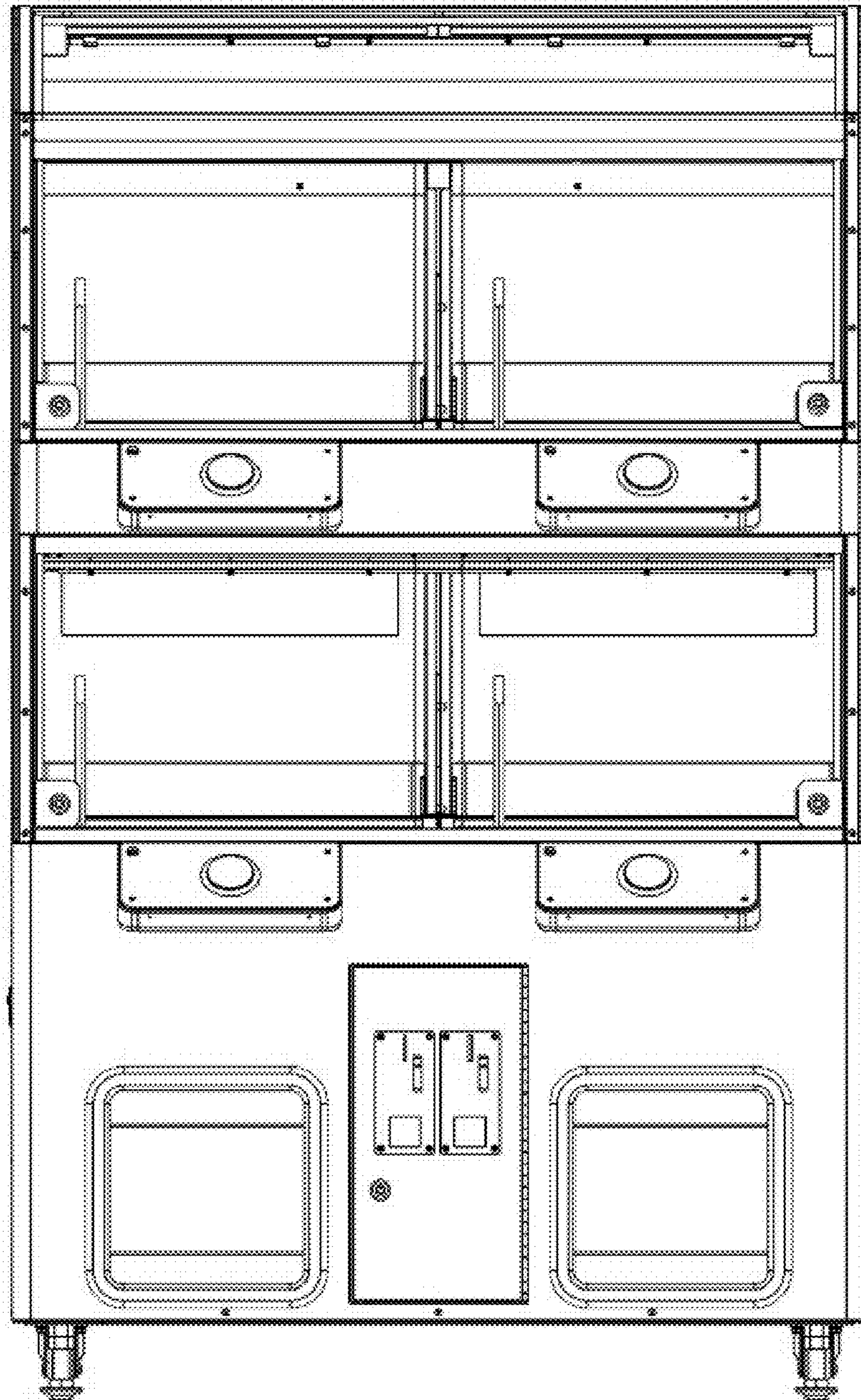

1.2

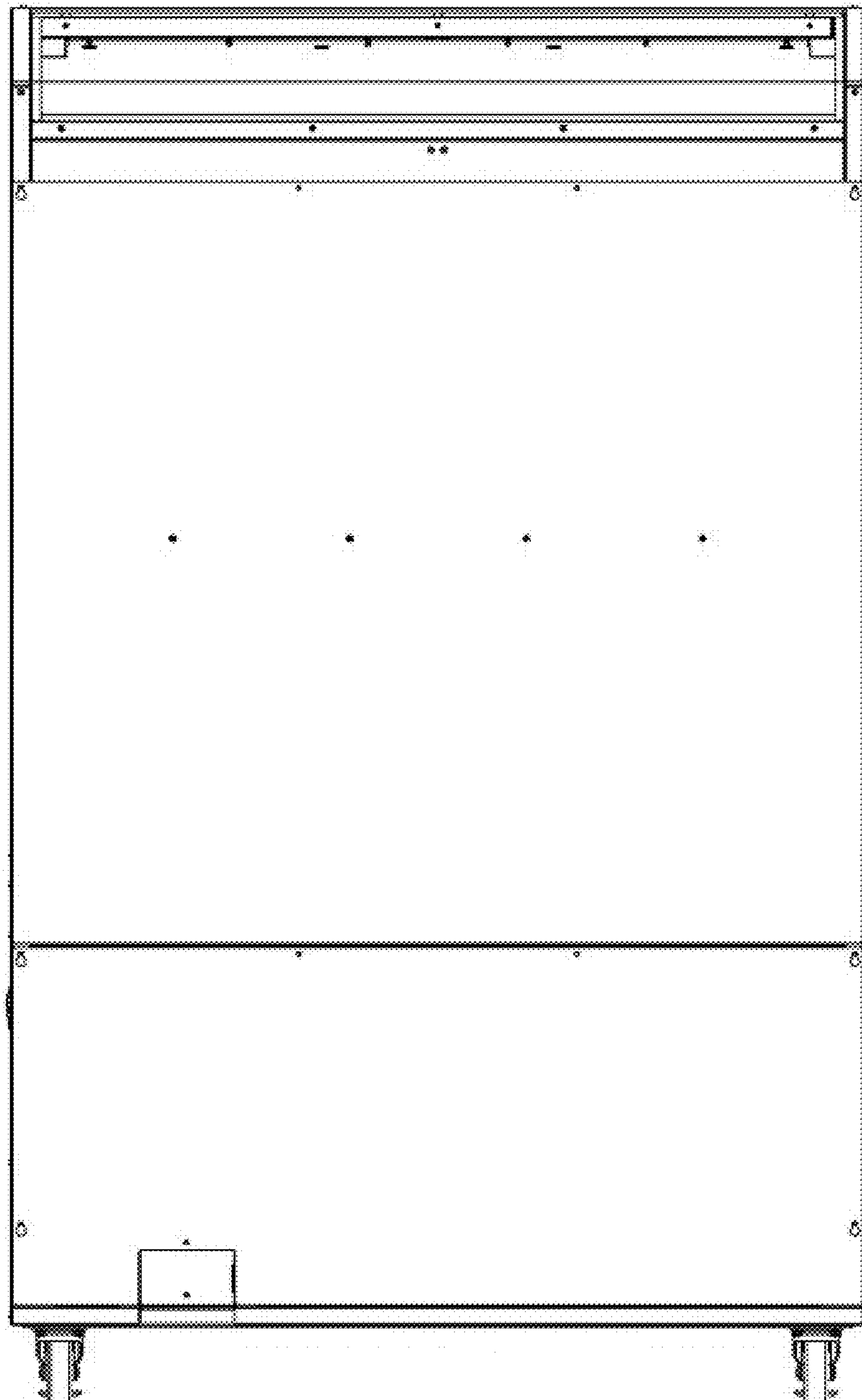

1.3

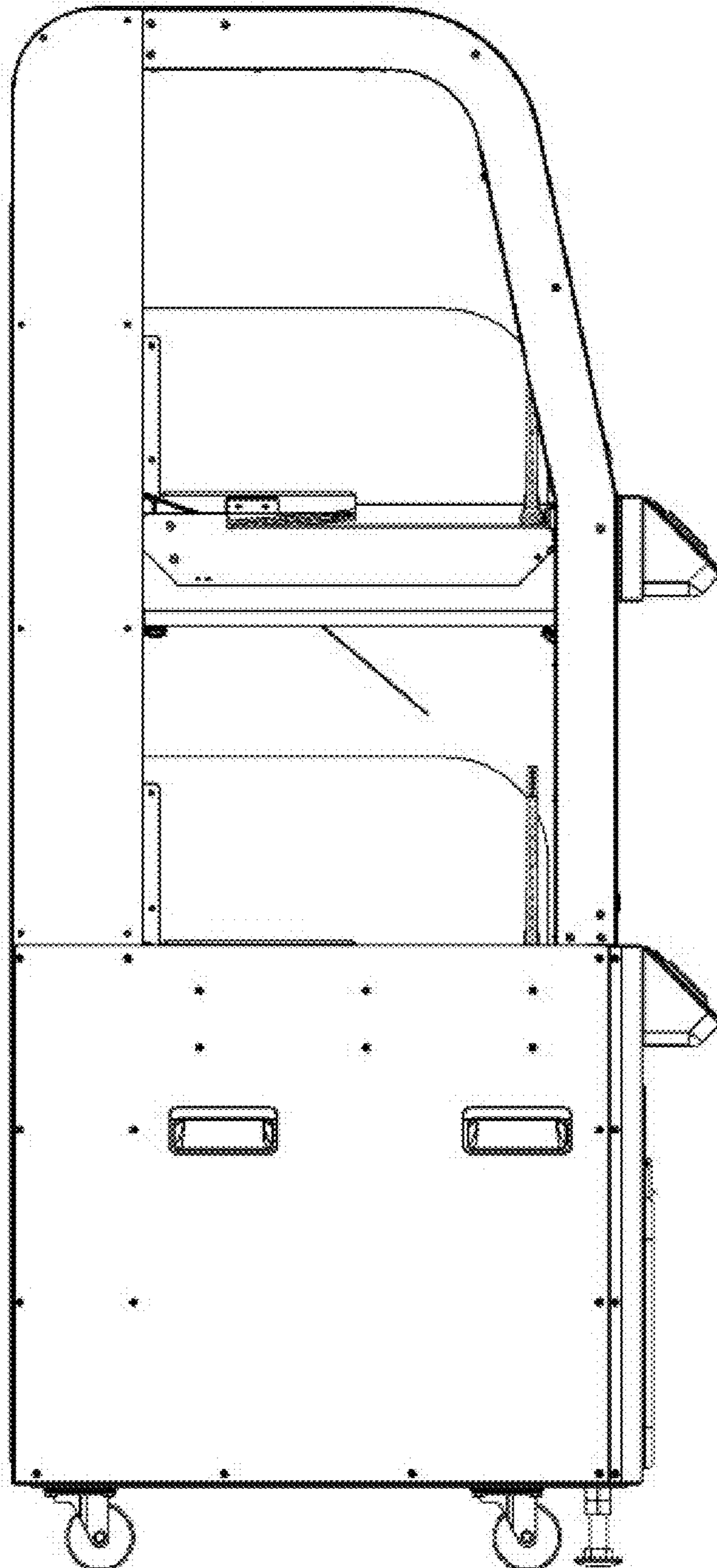

1.4

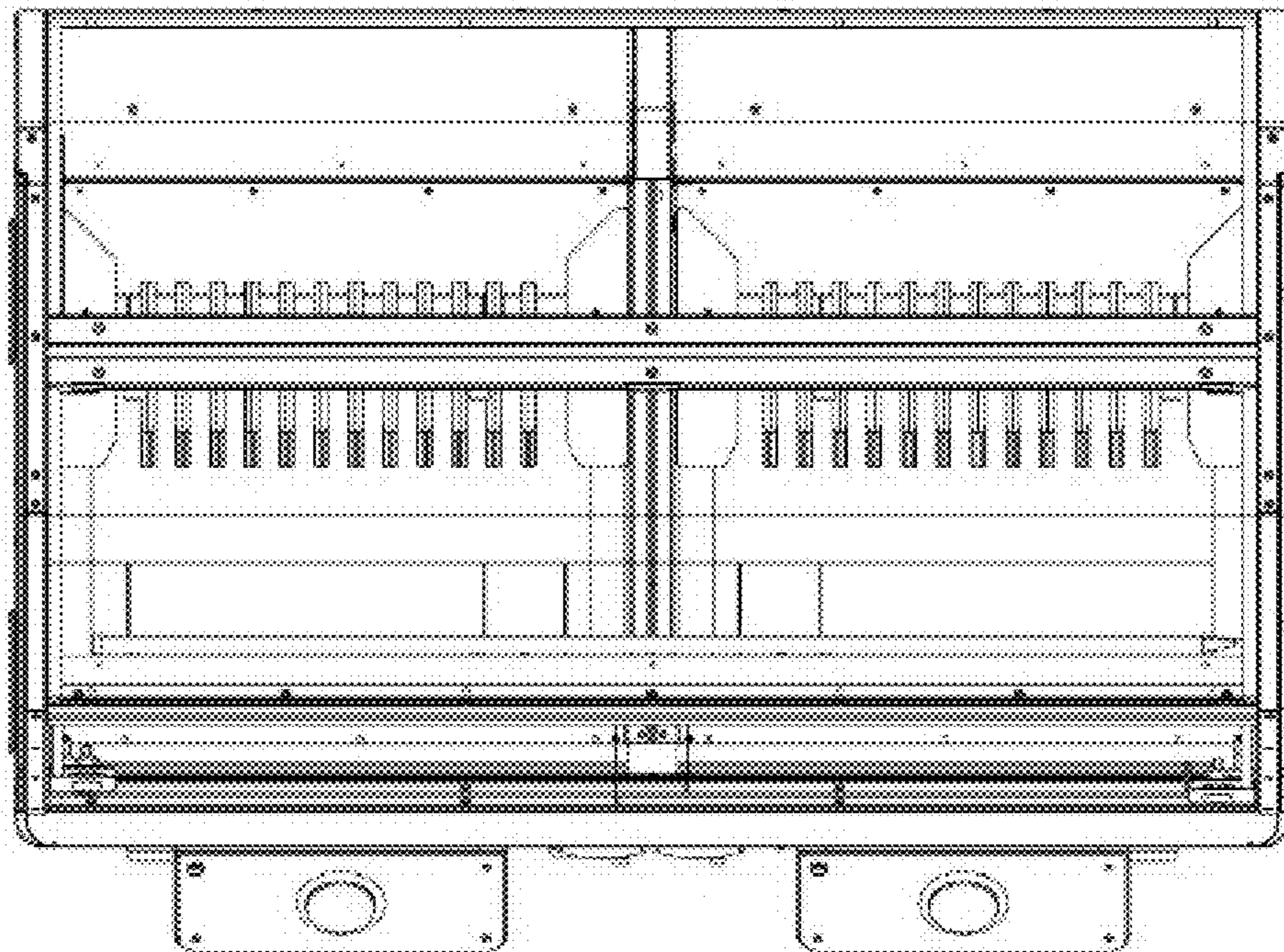

1.5

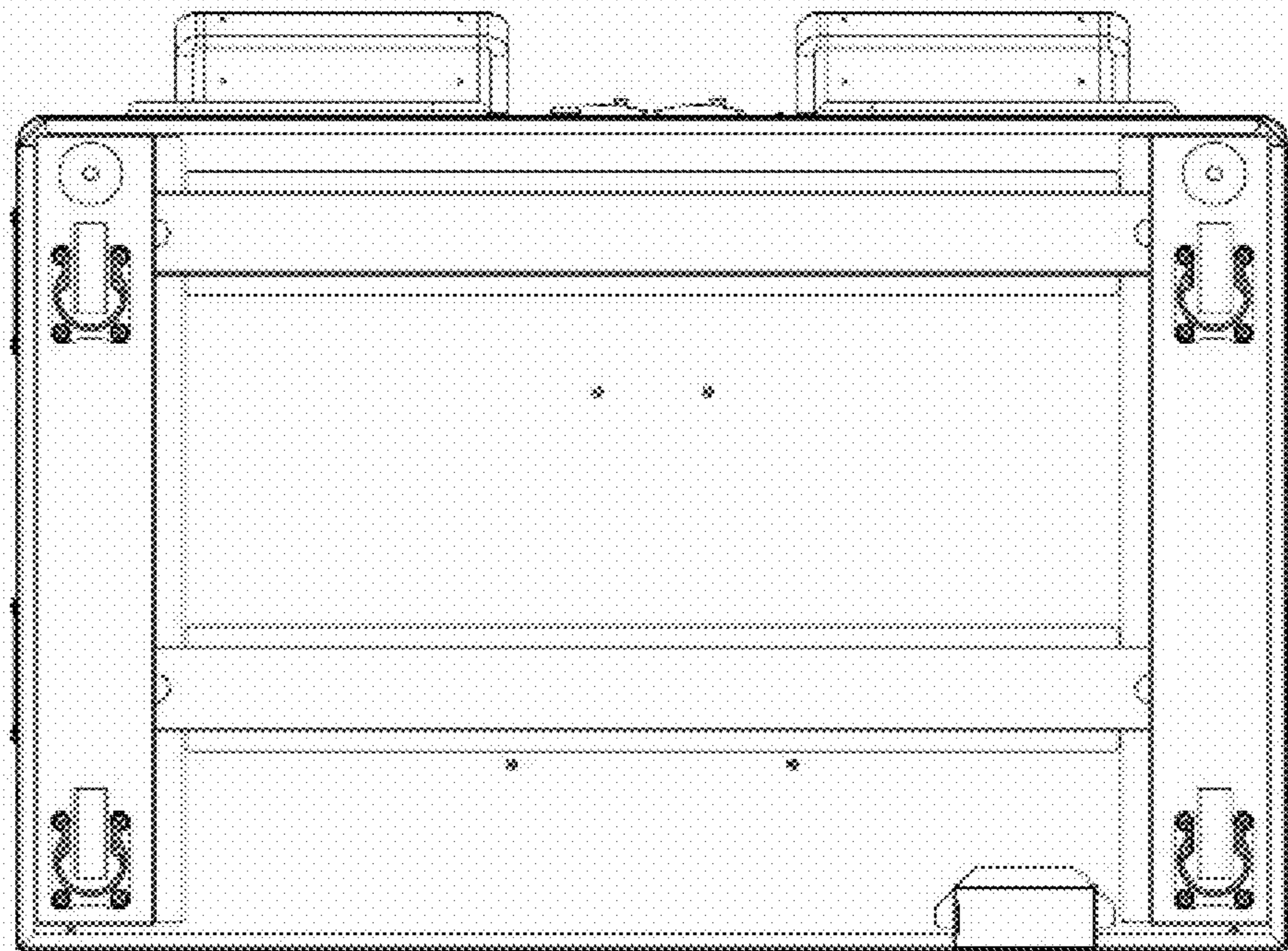

1.6

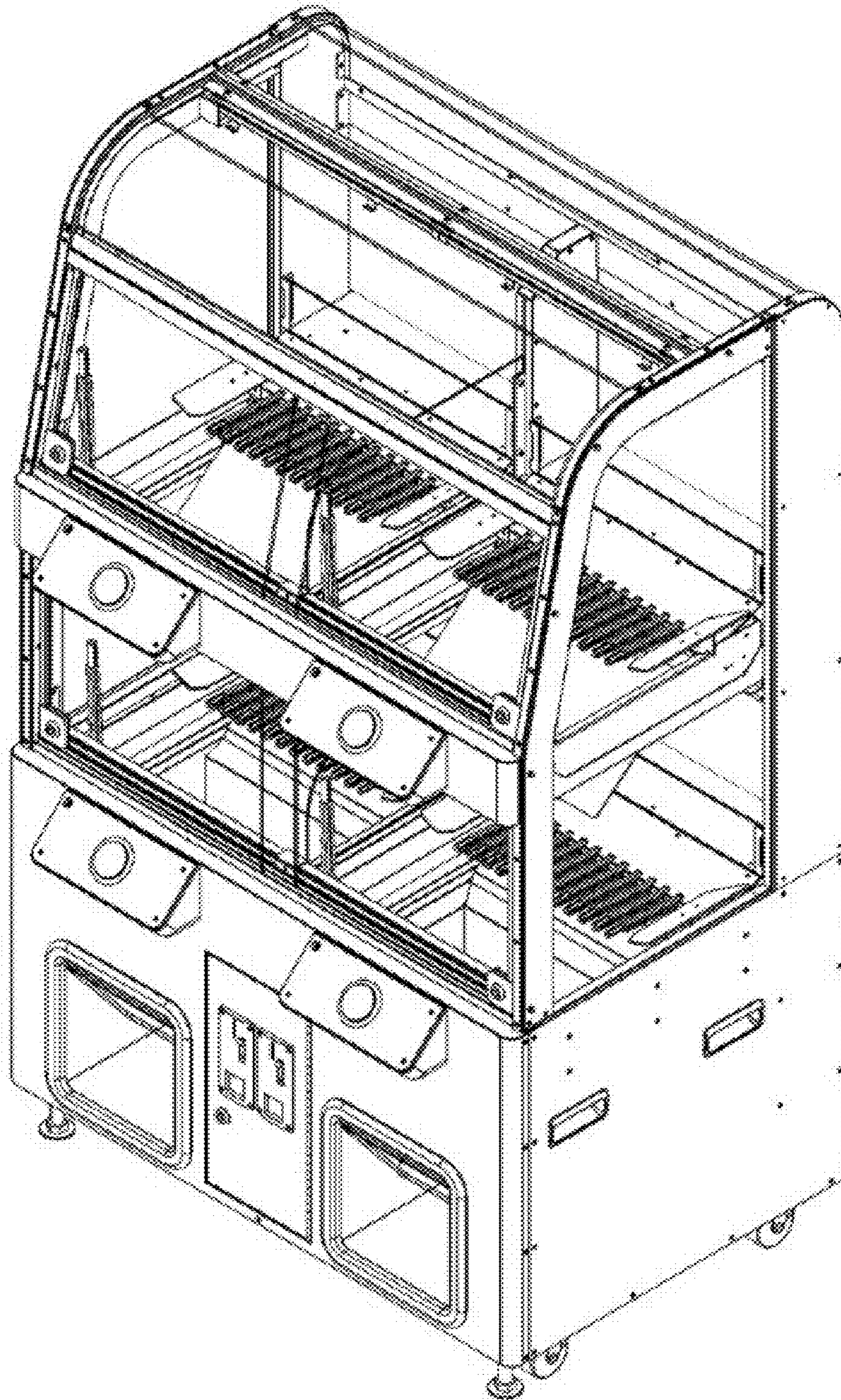

1.7

