



US00D949965S

(12) **United States Design Patent** (10) **Patent No.:** **US D949,965 S**
Harvey et al. (45) **Date of Patent:** **** Apr. 26, 2022**

(54) **INK CARTRIDGE**

FOREIGN PATENT DOCUMENTS

(71) Applicant: **Hewlett-Packard Development Company, L.P.**, Houston, TX (US)

EP 1122078 8/2001

(72) Inventors: **David C. Harvey**, Portland, OR (US);
David Olsen, Corvallis, OR (US);
Ralph L. Stathem, Lebanon, OR (US)

OTHER PUBLICATIONS

United States Patent and Trademark Office, "Final Office action," issued in connection with U.S. Appl. No. 29/402,509, dated May 25, 2018, 13 pages.

(73) Assignee: **Hewlett-Packard Development Company, L.P.**, Spring, TX (US)

(Continued)

(**) Term: **15 Years**

Primary Examiner — Calvin E Vansant

(21) Appl. No.: **29/665,760**

(74) *Attorney, Agent, or Firm* — Hanley Flight & Zimmerman LLC

(22) Filed: **Oct. 5, 2018**

(57) **CLAIM**

The ornamental design for an ink cartridge, as shown and described.

Related U.S. Application Data

DESCRIPTION

(63) Continuation of application No. 29/402,509, filed on Sep. 23, 2011.

(51) **LOC (13) Cl.** **18-02**

(52) **U.S. Cl.**
USPC **D18/56**

(58) **Field of Classification Search**
USPC D18/56
CPC B41J 2/175; B41J 2/17513
See application file for complete search history.

FIG. 1 is a front, top, and left side perspective view of an ink cartridge.

FIG. 2 is a rear, bottom, and right side perspective view of the ink cartridge of FIG. 1.

FIG. 3 is a rear, top, and right side perspective view of the ink cartridge of FIG. 1.

FIG. 4 is a rear, top, and left side perspective view of the ink cartridge of FIG. 1.

FIG. 5 is a left side view of the ink cartridge of FIG. 1.

FIG. 6 is a right side view of the ink cartridge of FIG. 1.

FIG. 7 is a top view of the ink cartridge of FIG. 1.

FIG. 8 is a bottom view of the ink cartridge of FIG. 1.

FIG. 9 is a front view of the ink cartridge of FIG. 1; and,

FIG. 10 is a rear view of the ink cartridge of FIG. 1.

The broken lines of the FIGURES are for illustration only. The broken lines and the unshaded regions bounded by broken lines form no part of the claimed design.

Line shading is not surface ornamentation.

The dash-dot lines indicate boundaries of the claimed design, and form no part thereof.

(56) **References Cited**

U.S. PATENT DOCUMENTS

D313,426 S *	1/1991	Berriman	D18/56
D361,343 S *	8/1995	Kaplinsky	347/87
D376,174 S *	12/1996	Tokuda	D18/56
6,155,678 A	12/2000	Komplin et al.		
D441,013 S *	4/2001	Kotaki	347/86
6,435,662 B2	8/2002	Kline et al.		
D464,672 S	10/2002	Shinano et al.		
D477,020 S *	7/2003	Seino	347/86
D489,757 S	5/2004	Matsumoto		

(Continued)

1 Claim, 10 Drawing Sheets

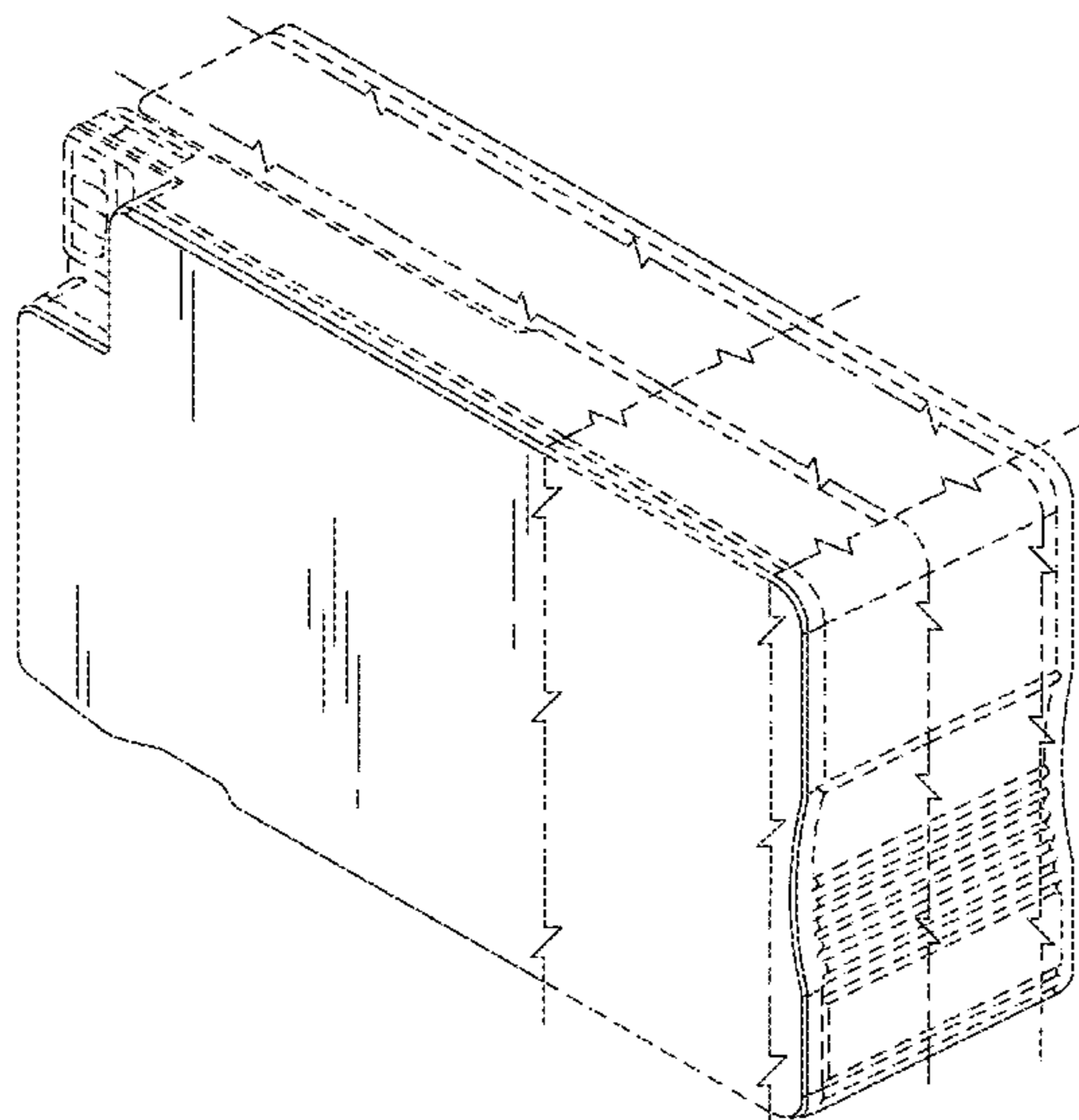

(56)

References Cited

U.S. PATENT DOCUMENTS

6,955,422 B2 10/2005 Miyazawa et al.
 7,018,027 B2 3/2006 Harada et al.
 D521,547 S * 5/2006 Jones 347/88
 D530,740 S * 10/2006 Engel D18/56
 7,125,108 B2 10/2006 Toba et al.
 D542,341 S * 5/2007 Hattori 347/86
 D549,280 S 8/2007 Morino
 D556,258 S 11/2007 Morino
 D571,853 S * 6/2008 Horiuchi D18/56
 D573,634 S * 7/2008 Horiuchi D18/56
 D585,090 S 1/2009 Ishizawa
 7,506,973 B2 3/2009 Steinmetz et al.
 7,552,997 B2 6/2009 Suzuki et al.
 D598,050 S 8/2009 Nozawa
 D611,532 S 3/2010 Nanjo et al.
 D612,417 S * 3/2010 Harada D18/56
 D656,183 S 3/2012 Nanjo et al.
 D656,186 S 3/2012 Oya et al.
 D665,841 S * 8/2012 Williamson D18/56
 D675,252 S * 1/2013 Harvey D18/56
 D678,406 S 3/2013 Yonekawa et al.
 D680,165 S 4/2013 Takagi et al.
 D680,582 S * 4/2013 Harvey D18/56
 D681,728 S 5/2013 Takagi et al.
 8,449,091 B2 5/2013 Kanbe et al.
 D699,785 S 2/2014 Harvey et al.
 D707,290 S * 6/2014 Harvey D18/56
 D712,464 S 9/2014 Harvey et al.
 D712,466 S * 9/2014 Nagashima D18/56
 D729,312 S * 5/2015 Harvey B41J 2/17513
 D780,257 S * 2/2017 Kimura B41J 2/17513
 D786,347 S * 5/2017 Okazaki B41J 2/17513
 D875,828 S * 2/2020 Harvey B41J 2/1755
 2005/0001888 A1 1/2005 Seino et al.
 2005/0211594 A1 * 9/2005 Katsuyama B41J 2/1755
 206/461

2007/0052773 A1 * 3/2007 Kawamura B41J 2/17513
 347/86
 2007/0263052 A1 * 11/2007 Iijima B41J 2/17513
 347/92
 2008/0165232 A1 7/2008 Yuen
 2008/0180495 A1 7/2008 Gonzales
 2008/0239036 A1 10/2008 Hattori
 2009/0141097 A1 6/2009 Nakamura et al.
 2009/0141103 A1 6/2009 Takagi
 2010/0277554 A1 * 11/2010 Sulser B41J 2/17513
 347/86
 2011/0310187 A1 12/2011 Kanbe et al.
 2013/0050359 A1 2/2013 Kanbe et al.

OTHER PUBLICATIONS

United States Patent and Trademark Office, "Non-Final Office action," issued in connection with U.S. Appl. No. 29/402,509, dated Nov. 17, 2017, 12 pages.
 United States Patent and Trademark Office, "Final Office action," issued in connection with U.S. Appl. No. 29/402,509, dated Dec. 11, 2013, 11 pages.
 United States Patent and Trademark Office, "Non-Final Office action," issued in connection with U.S. Appl. No. 29/402,509, dated Aug. 28, 2013, 12 pages.
 United States Patent and Trademark Office, "Final Office action," issued in connection with U.S. Appl. No. 29/402,509, dated May 2, 2013, 9 pages.
 United States Patent and Trademark Office, "Non-Final Office action," issued in connection with U.S. Appl. No. 29/402,509, dated Dec. 19, 2012, 10 pages.
 One photograph of a brother LC110 Ink supply cartridge and shipping container, one photograph comprising three EPSON ink cartridges, models T0692, T0693, T0694, one photograph of 170 ml Canon LF aqueous supplies and shipping container, one photograph of HP large format DesignJet cartridges and shipping container, all on two pages. To the best of applicant's knowledge, all of the products shown in the photographs were on sale in the United States more than one year prior to the filing date of the parent application.

* cited by examiner

FIG. 1

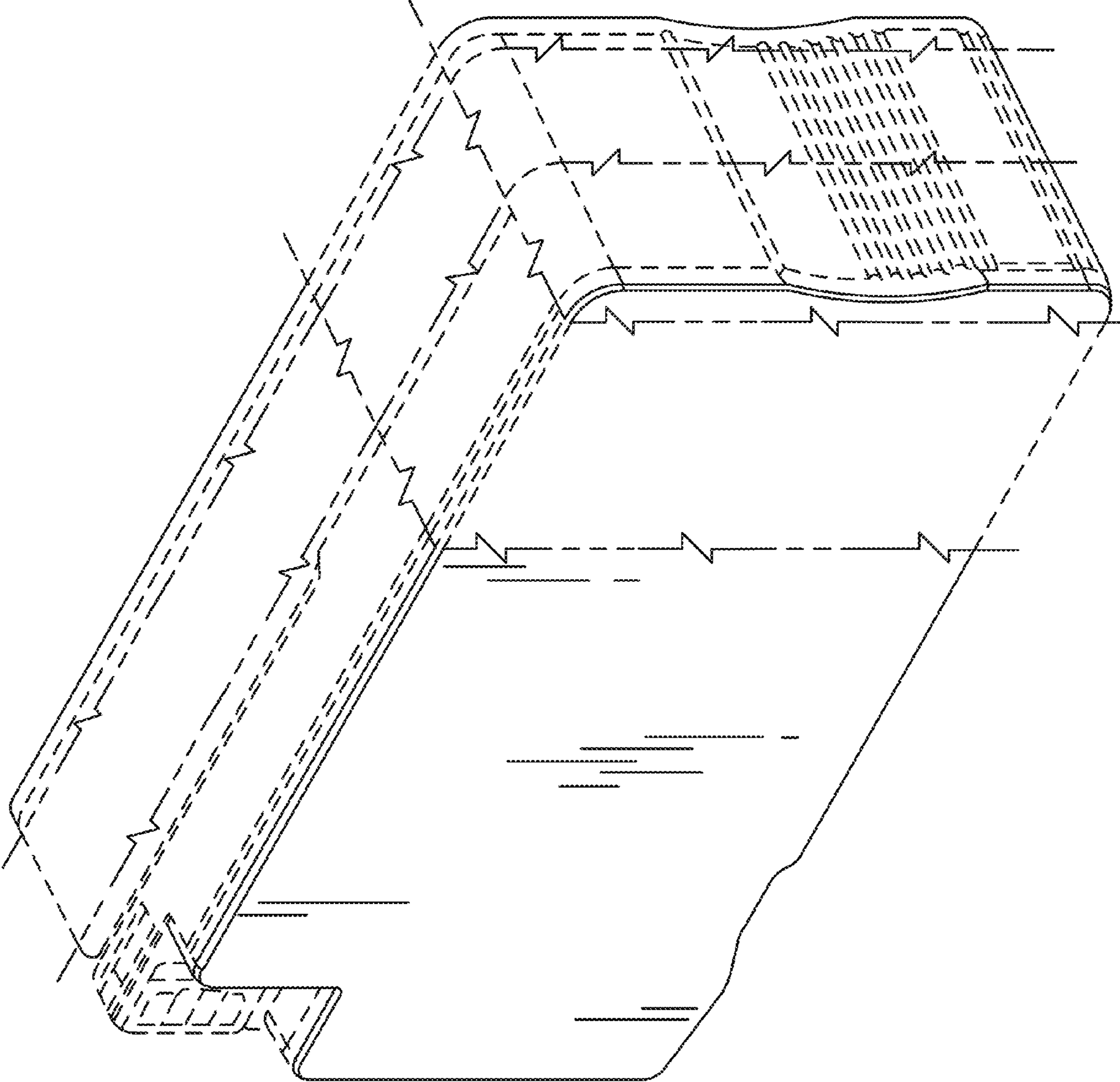
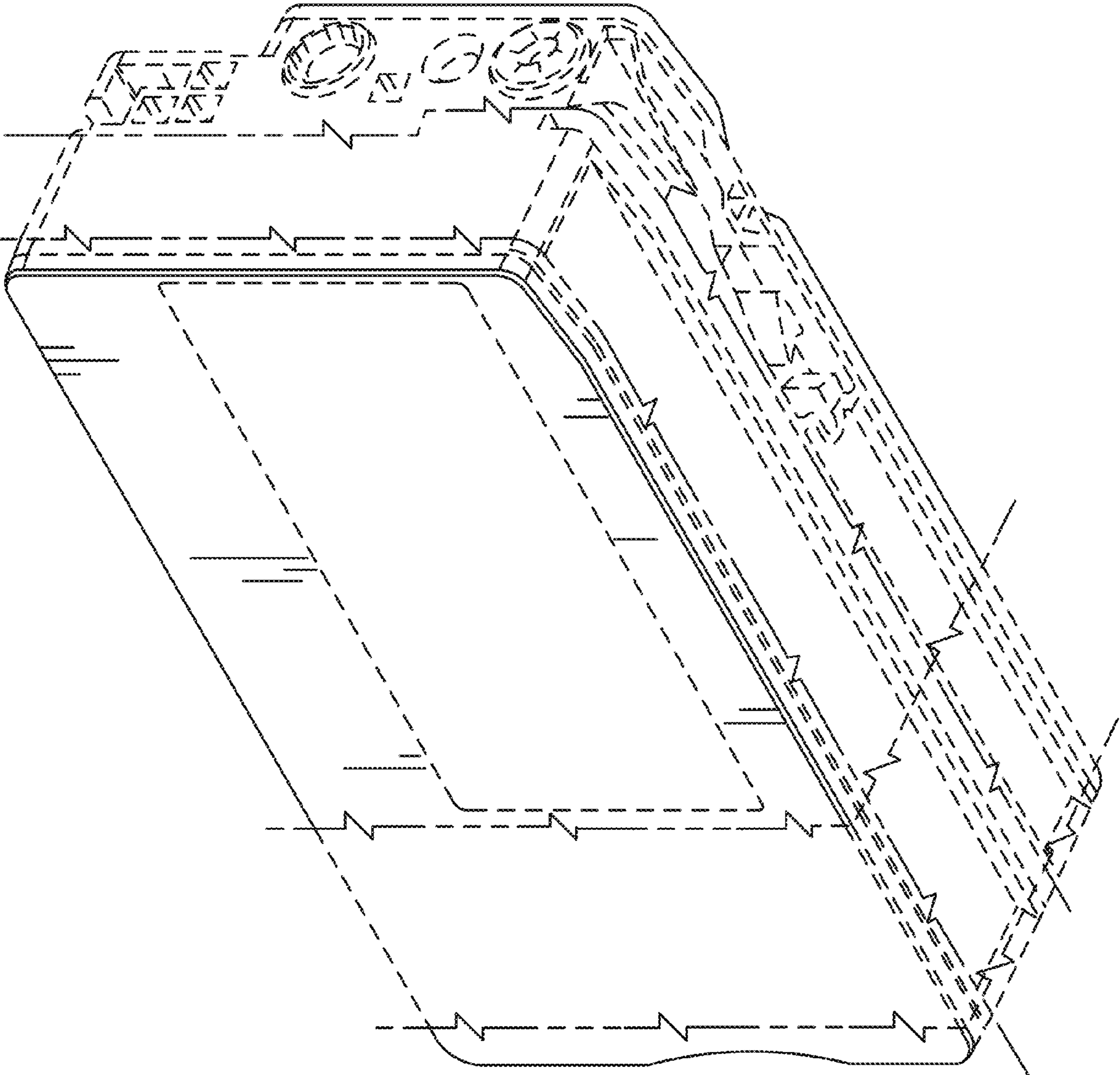

FIG. 2



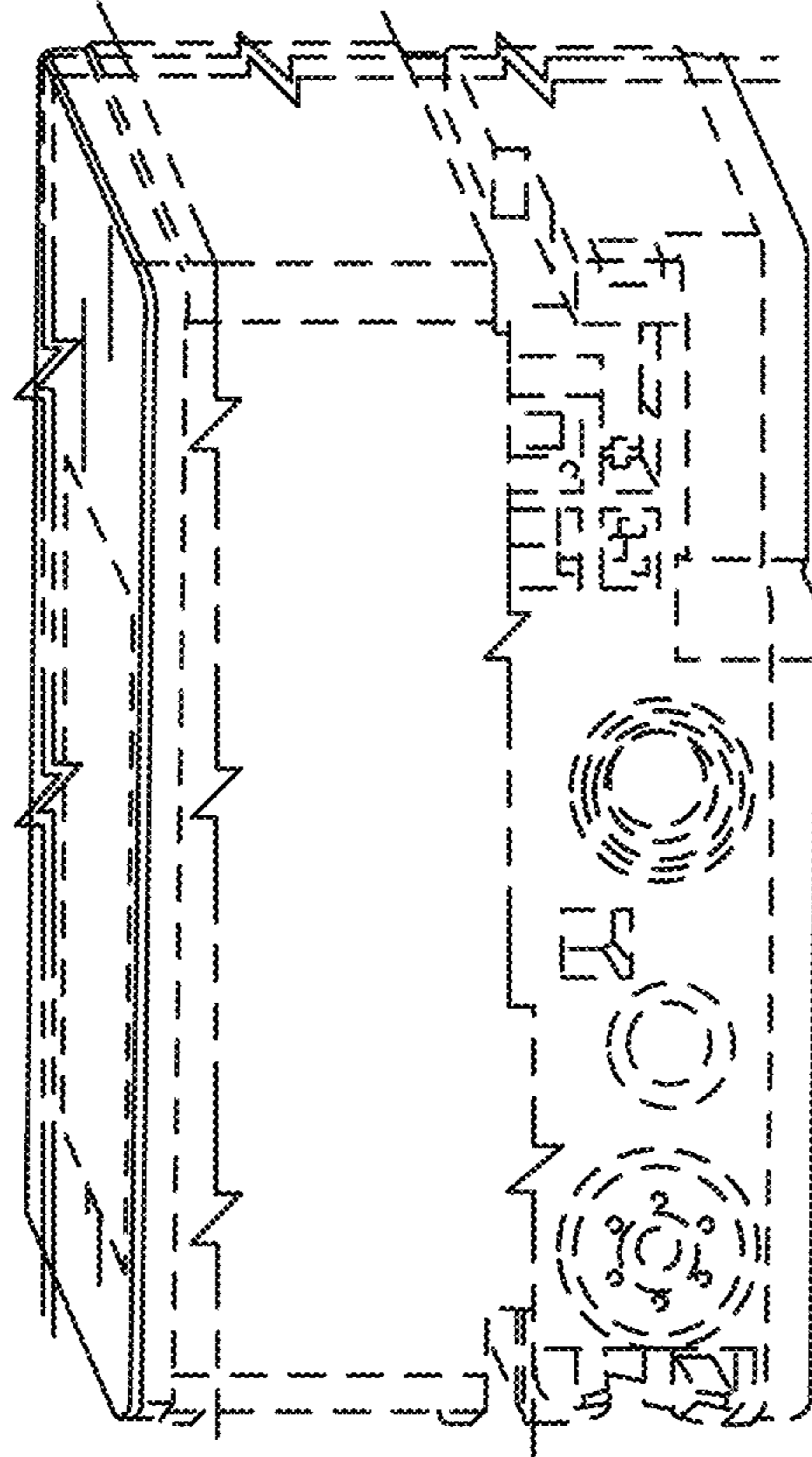

FIG. 3

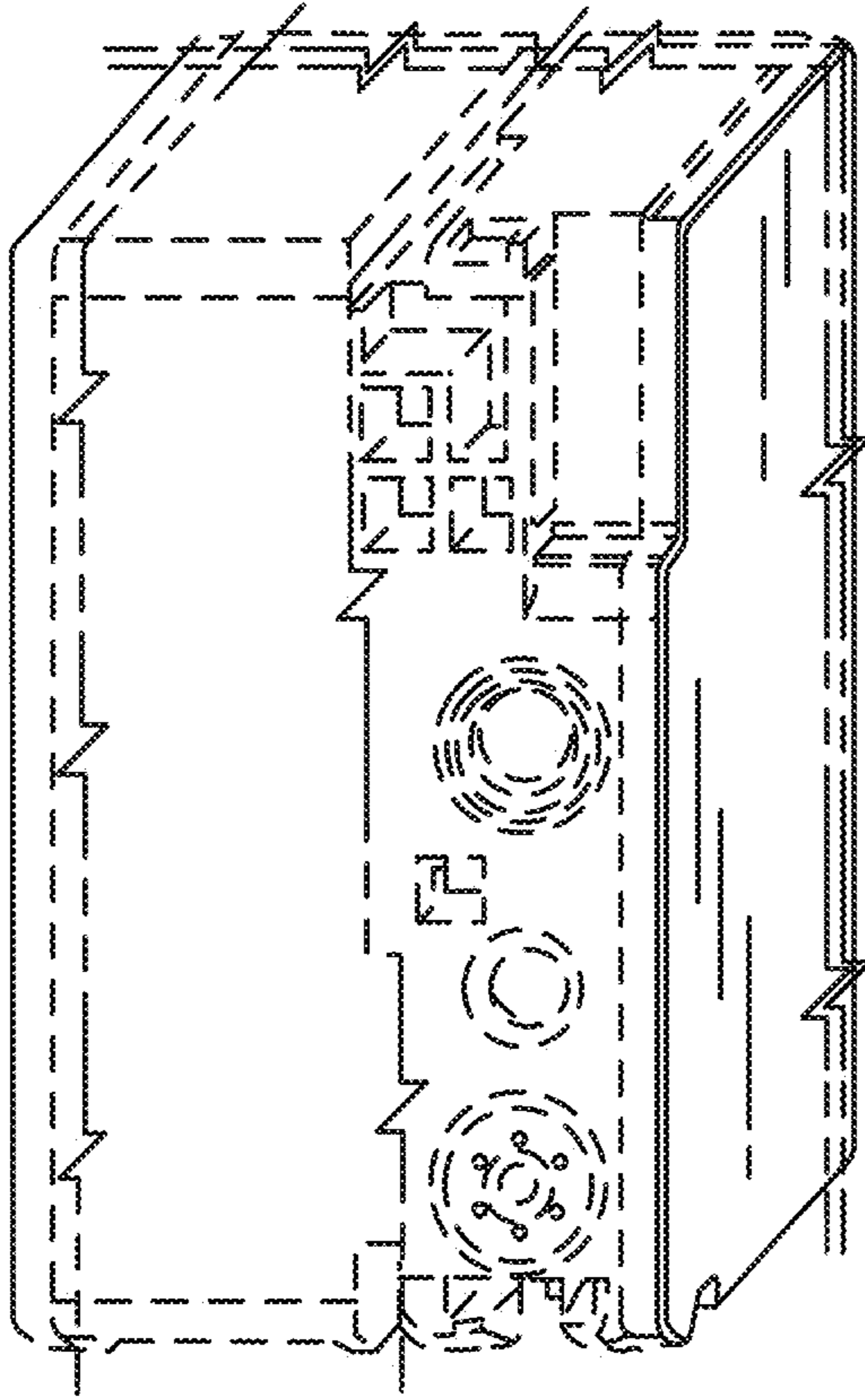
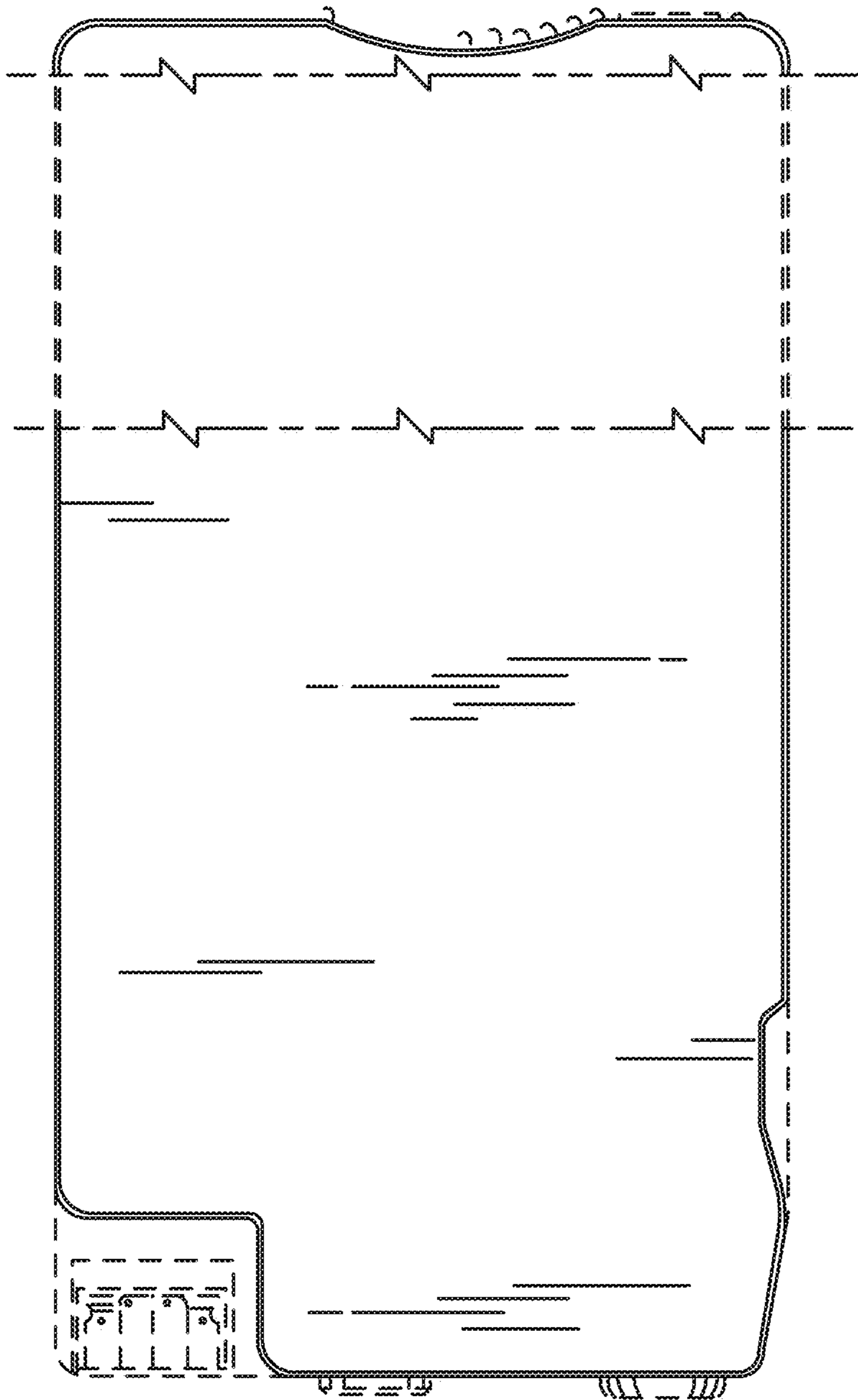

FIG. 4

FIG. 5



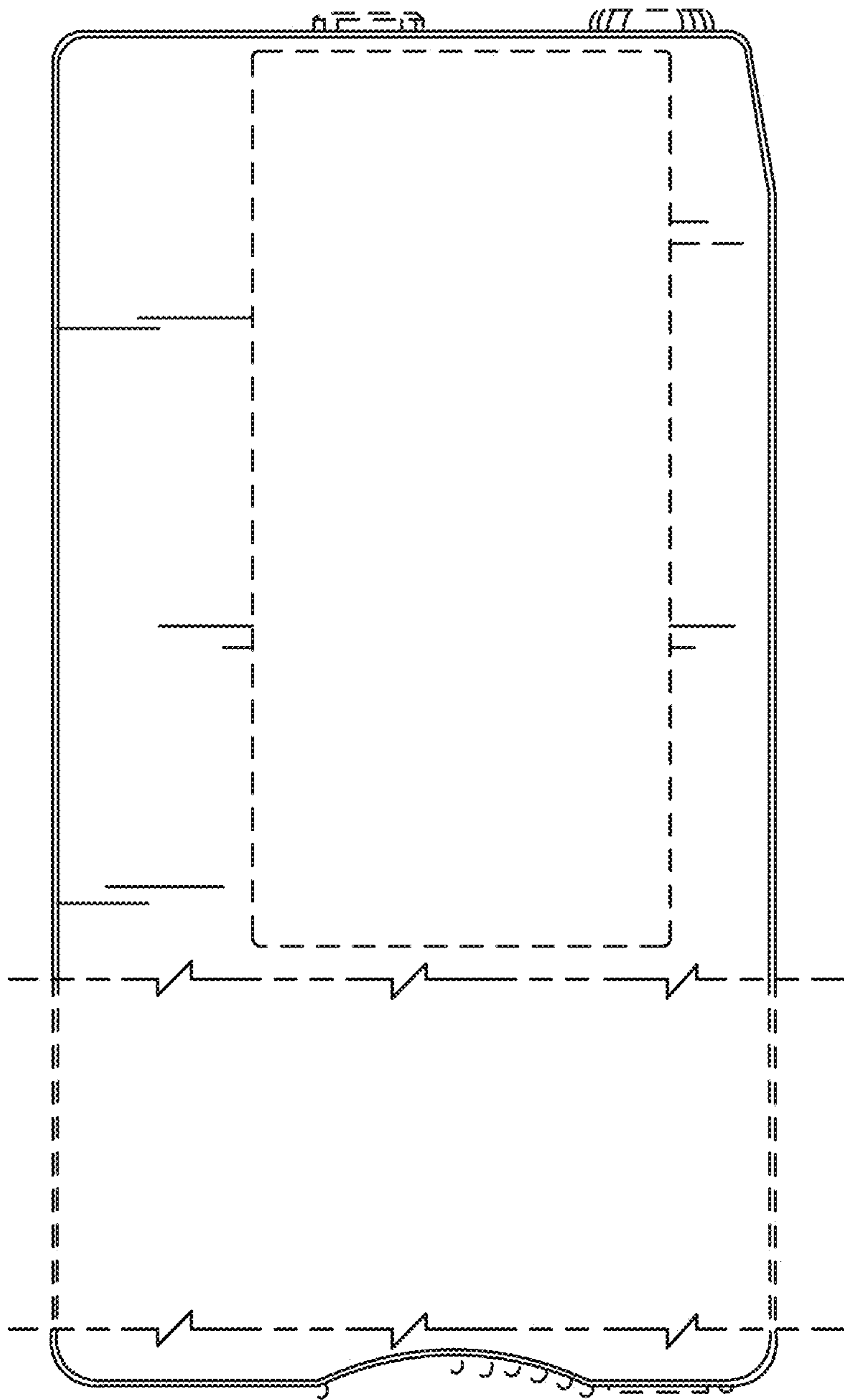

FIG. 6

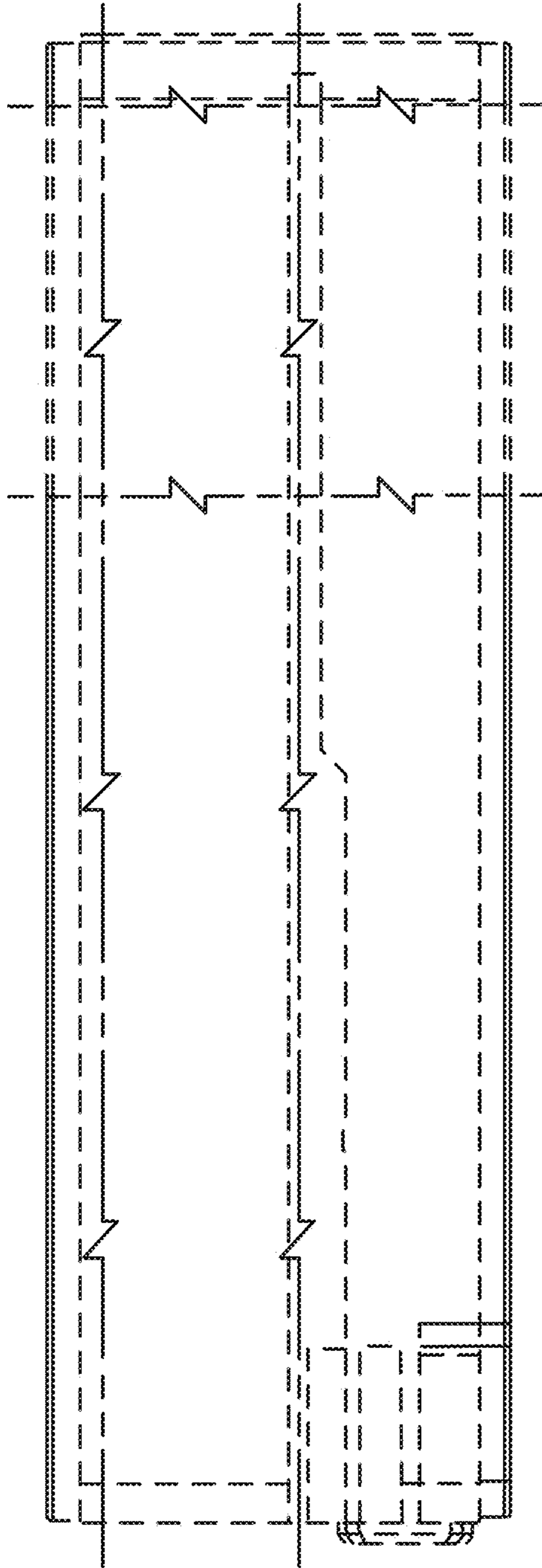

FIG. 7

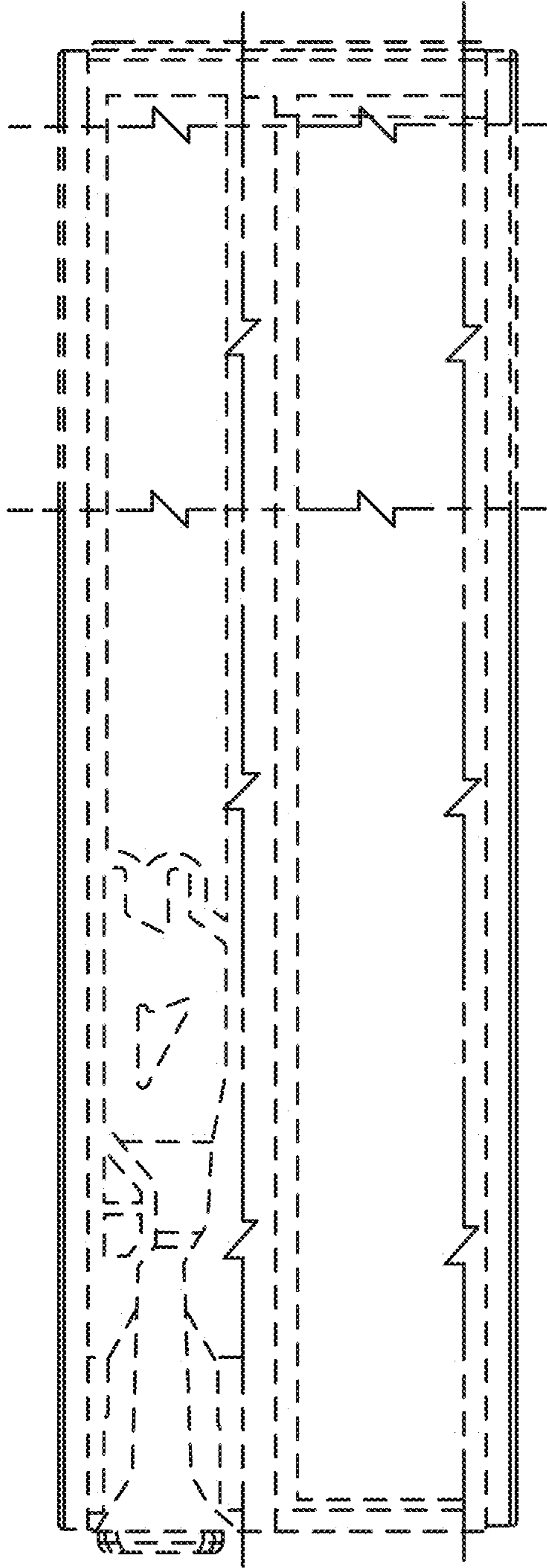

FIG. 8

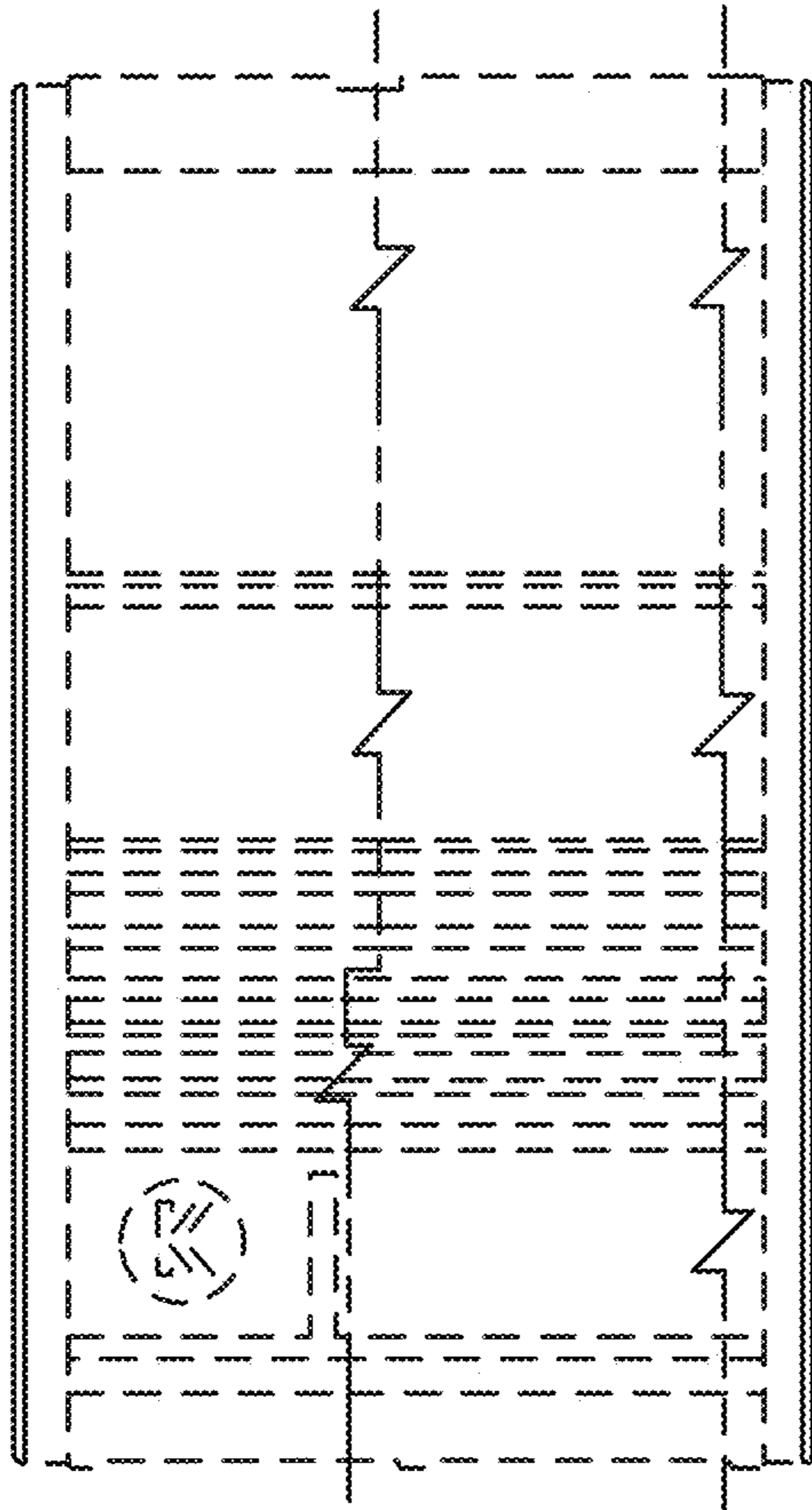

FIG. 9

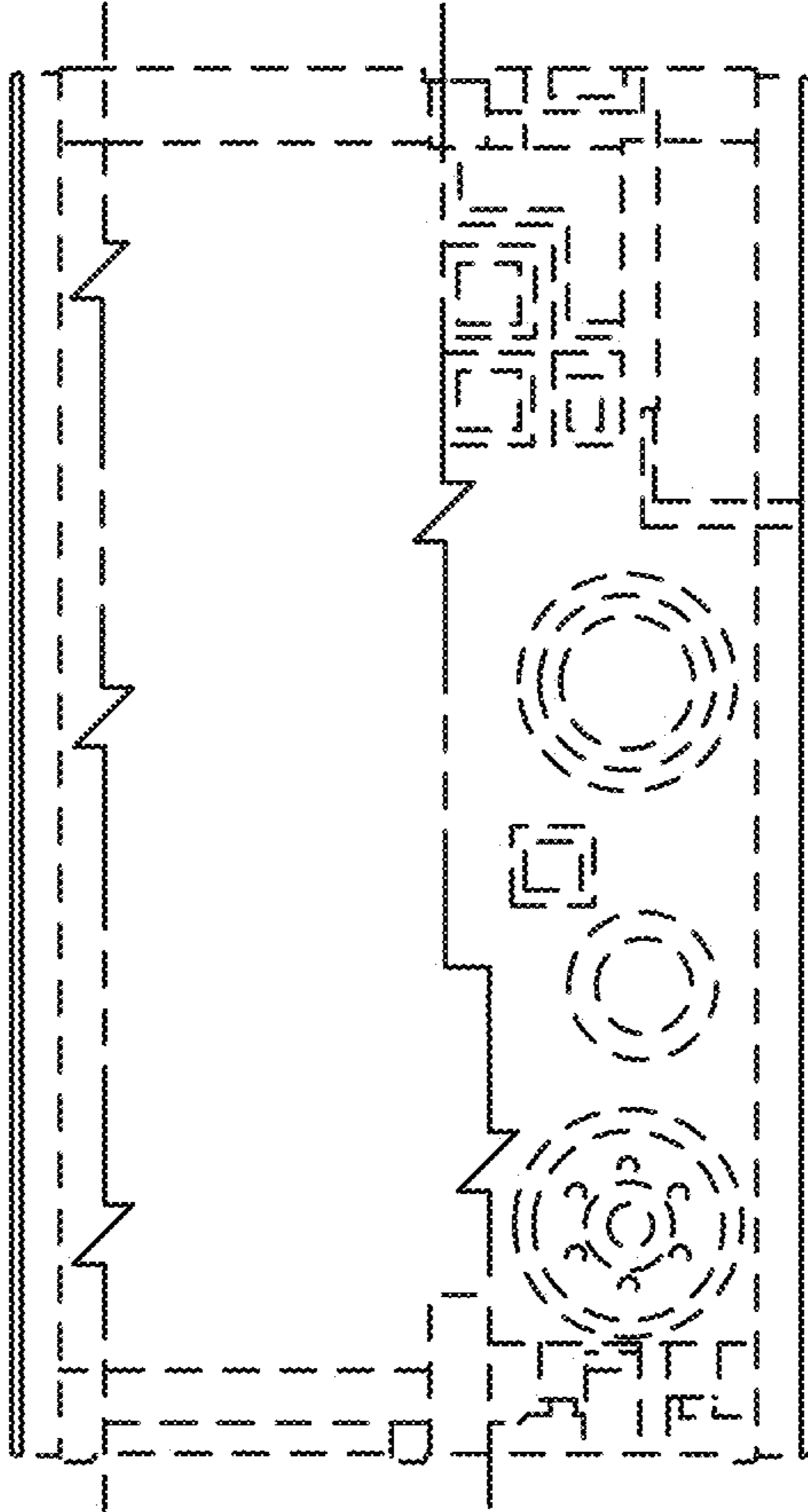

FIG. 10