

US00D949954S

(12) **United States Design Patent** (10) **Patent No.:** **US D949,954 S**
Sitt et al. (45) **Date of Patent:** **** Apr. 26, 2022**

(54) **EYE MASK**
(71) Applicant: **Please Me LLC**, Brooklyn, NY (US)
(72) Inventors: **Carolyn Sitt**, Brooklyn, NY (US);
Eddie Sitt, Brooklyn, NY (US)
(73) Assignee: **PLEASE ME LLC**, Brooklyn, NY (US)
(**) Term: **15 Years**
(21) Appl. No.: **29/739,602**
(22) Filed: **Jun. 26, 2020**
(51) **LOC (13) Cl.** **16-06**
(52) **U.S. Cl.**
USPC **D16/301**
(58) **Field of Classification Search**
USPC D16/300, 301
CPC G02C 5/008; G02C 3/003; G02C 5/146;
G02C 9/00; G02C 11/04; G02C 11/00;
G02C 1/06; G02C 1/10; G02C 5/006;
A61F 9/04
See application file for complete search history.

(56) **References Cited**
U.S. PATENT DOCUMENTS
D324,734 S * 3/1992 Burgess D24/207
D631,500 S * 1/2011 Schenk D16/301
D861,772 S * 10/2019 Lian D16/301
D907,224 S * 1/2021 Wang D24/206
D911,429 S * 2/2021 Guo D16/301

OTHER PUBLICATIONS
Aroma Season Heated Eye Mask, posted at amazon.com, posting date by Mar. 23, 2019, [online], [site visited Dec. 8, 2021]. Available from Internet, URL: <https://www.amazon.com/dp/B07LBL172C/> (Year: 2019).*

Cheroo Heated Eye Mask, posted at amazon.com, posting date by Feb. 14, 2021, [online], [site visited Dec. 8, 2021]. Available from Internet, URL: https://www.amazon.com/Lavender-Weighted-Compress-Adjustable-Blepharitis/dp/B08T97LNP6/ref=cm_cr_arp_d_product_top?ie=UTF8 (Year: 2021).*
MEISENHOME Heated Eye Mask, posted at amazon.com, posting date by Nov. 13, 2020, [online], [site visited Dec. 8, 2021]. Available from Internet, URL: https://www.amazon.com/MEISENHOME-Blepharitis-Treatment-Flaxseed-Chalazion/dp/B08TTGYKV6/ref=cm_cr_arp_d_product_top?ie=UTF8&th=1 (Year: 2020).*
Morliden Heated Eye Mask for Dry Eyes, posted at amazon.com, posting date by Feb. 10, 2021, [online], [site visited Dec. 8, 2021]. Available from Internet, URL: https://www.amazon.com/Natural-Flaxseed-Compress-Adjustable-Temperature/dp/B08TTYLHQL/ref=cm_cr_arp_d_product_top?ie=UTF8&th=1 (Year: 2021).*

* cited by examiner
Primary Examiner — Maria J. Edwards
(74) *Attorney, Agent, or Firm* — Foley & Lardner LLP

(57) **CLAIM**
We claim the ornamental design for an eye mask, as shown and described.

DESCRIPTION
FIG. 1 is a front perspective view from above of the claimed eye mask;
FIG. 2 is a front view of the claimed design of FIG. 1;
FIG. 3 is a rear view of the claimed design of FIG. 1;
FIG. 4 is a right side view of the claimed design of FIG. 1;
FIG. 5 is a left side view of the claimed design of FIG. 1;
FIG. 6 is a top view of the claimed design of FIG. 1; and
FIG. 7 is a bottom view of the claimed design of FIG. 1.
Any portion of the article depicted in broken lines forms no part of the claimed design.

1 Claim, 5 Drawing Sheets

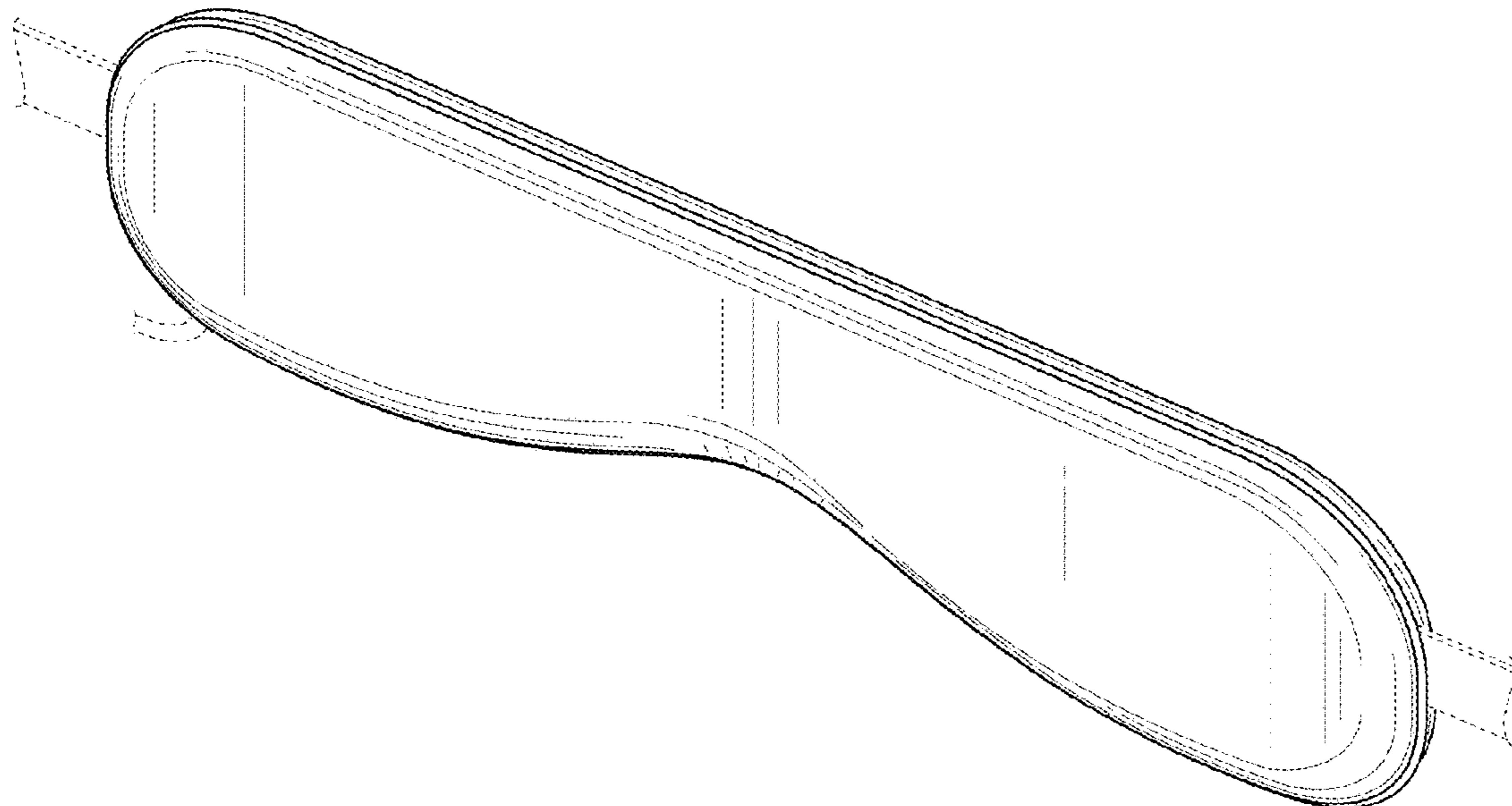

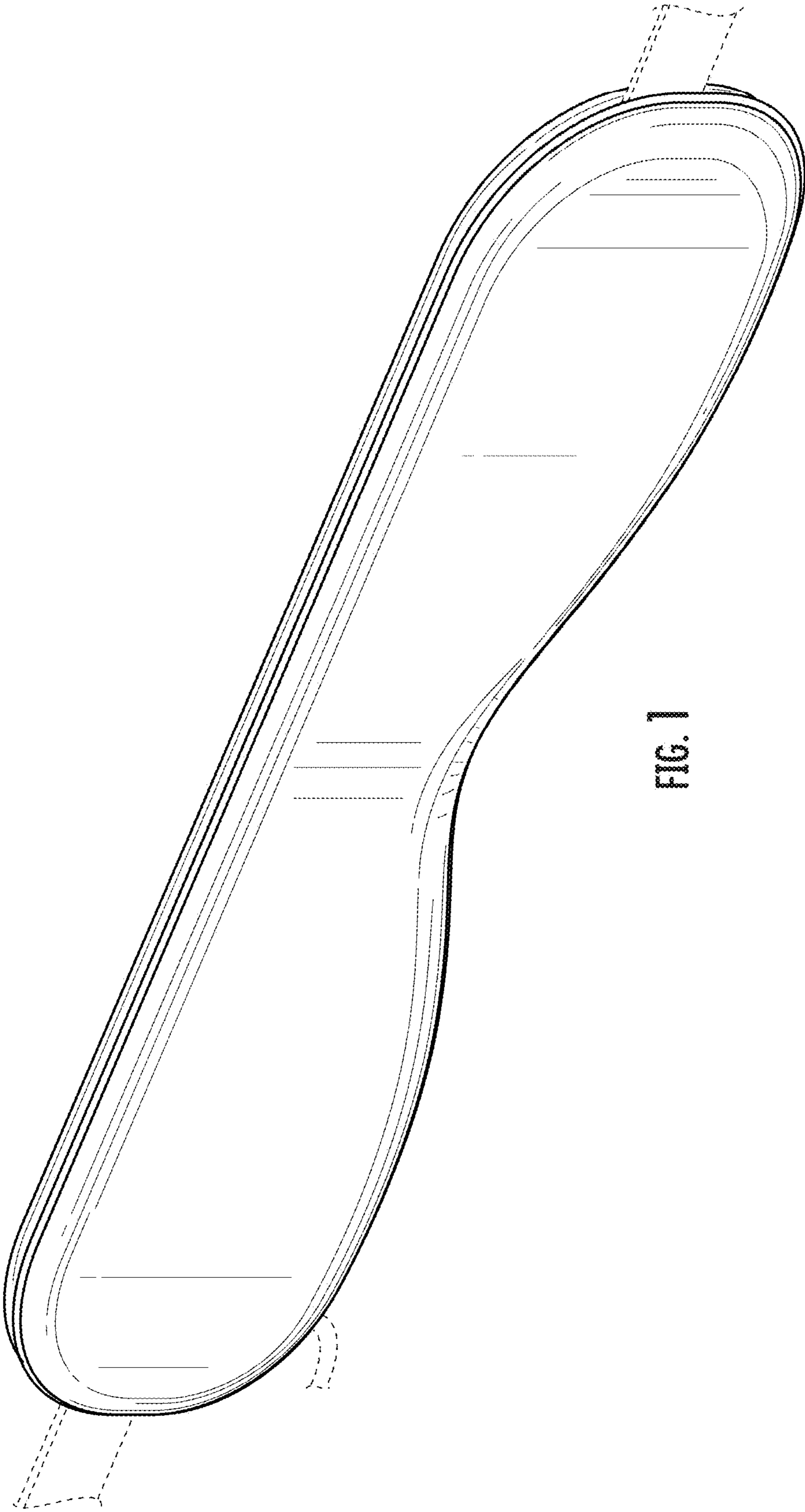

FIG. 1

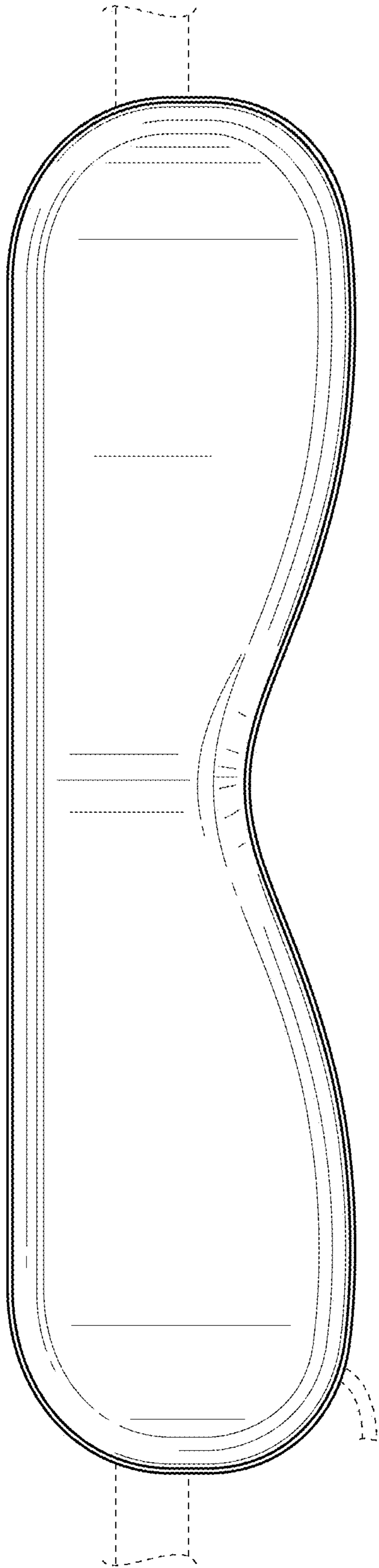

FIG. 2

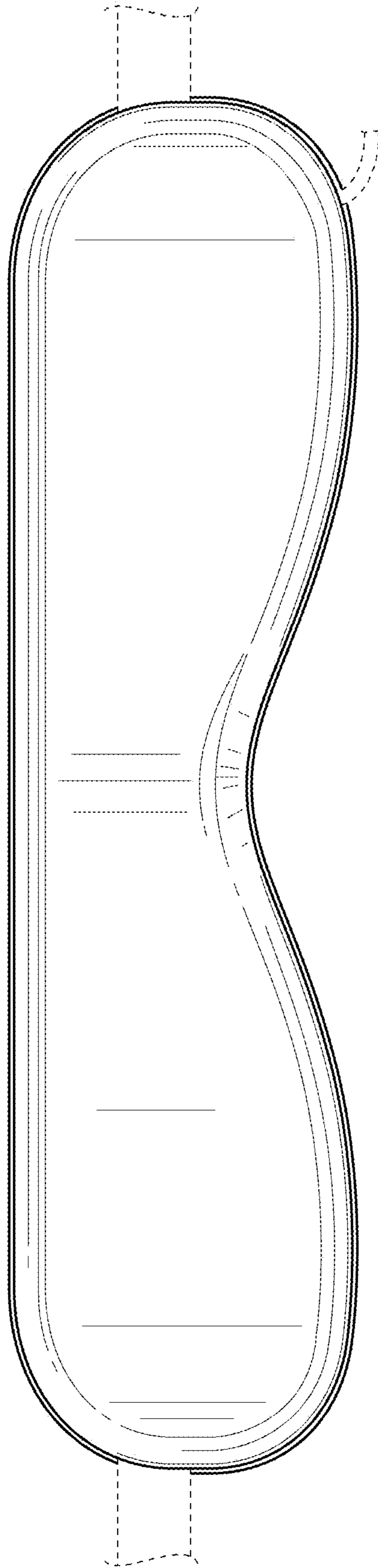

FIG. 3



FIG. 4

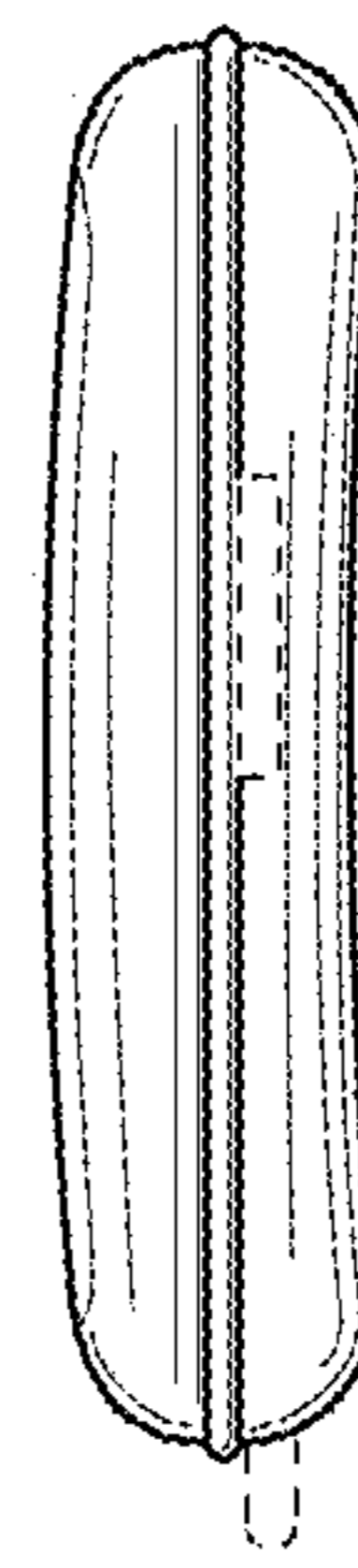

FIG. 5

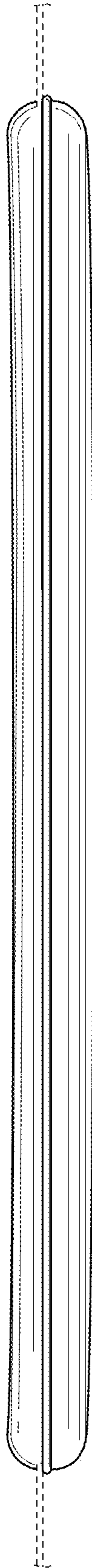

FIG. 6

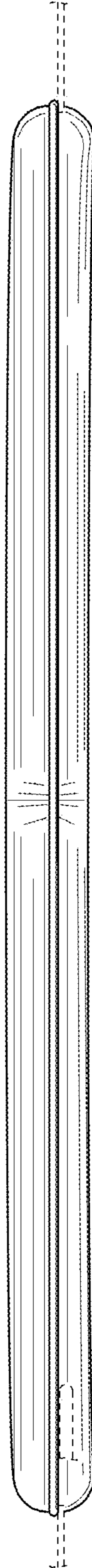

FIG. 7