



US00D949946S

(12) **United States Design Patent**
Sakai

(10) **Patent No.:** **US D949,946 S**

(45) **Date of Patent:** **** Apr. 26, 2022**

(54) **LENS FOR CAMERA**

(71) Applicant: **FUJIFILM Corporation**, Tokyo (JP)

(72) Inventor: **Hiroyuki Sakai**, Saitama (JP)

(73) Assignee: **FUJIFILM Corporation**, Tokyo (JP)

(**) Term: **15 Years**

(21) Appl. No.: **29/647,045**

(22) Filed: **May 9, 2018**

Related U.S. Application Data

(62) Division of application No. 29/594,342, filed on Feb. 17, 2017, now Pat. No. Des. 842,918.

(30) **Foreign Application Priority Data**

Aug. 23, 2016 (JP) 2016-017867
Aug. 23, 2016 (JP) 2016-017868
Aug. 23, 2016 (JP) 2016-017869

(51) **LOC (13) Cl.** **16-05**

(52) **U.S. Cl.**
USPC **D16/219**

(58) **Field of Classification Search**
USPC D16/200-220, 131
CPC ... G02B 7/02; G02B 7/04; G02B 7/14; G02B 3/14; G03B 17/00; G03B 17/02; G03B 17/56; G03B 17/04; G03B 17/14; G03B 15/03; G03B 9/08; H04N 5/2251; H04N 5/2252; H04N 5/2253; H04N 5/2254; H04N 7/00; H04N 2101/00; F16M 13/00
See application file for complete search history.

(56) **References Cited**

U.S. PATENT DOCUMENTS

2,136,149 A 11/1938 Nuchterlein
D150,228 S 7/1948 Harvey
2,902,901 A 9/1959 Back

D240,766 S 7/1976 Franzmann
D247,782 S * 4/1978 Blumberg D16/136
D303,976 S 10/1989 Kimura
(Continued)

FOREIGN PATENT DOCUMENTS

JP HC26020384 3/2015

OTHER PUBLICATIONS

Machined Flat Washer with Beveled Outside Edge, published Jun. 11, 2011 [online], [retrieved Jan. 18, 2018], Available from Internet, URL: <<http://washersmall.blogspot.com/2011/06/>>.*

(Continued)

Primary Examiner — Kevin K Rudzinski
(74) *Attorney, Agent, or Firm* — Sughrue Mion, PLLC

(57) **CLAIM**

The ornamental design for a lens for camera, as shown and described.

DESCRIPTION

The file of this patent contains at least one drawing executed in color. Copies of this patent with color drawings will be provided by the United States Patent and Trademark Office upon request and payment of the necessary fee.

FIG. 1 is a front view of a lens for camera showing my new design;

FIG. 2 is a rear view thereof;

FIG. 3 is a plan view thereof;

FIG. 4 is a bottom view thereof;

FIG. 5 is a right side view thereof;

FIG. 6 is a left side view thereof; and,

FIG. 7 is a perspective view thereof.

The broken lines shown in the drawings depict portions of the lens for camera that form no part of the claimed design.

1 Claim, 5 Drawing Sheets
(5 of 5 Drawing Sheet(s) Filed in Color)

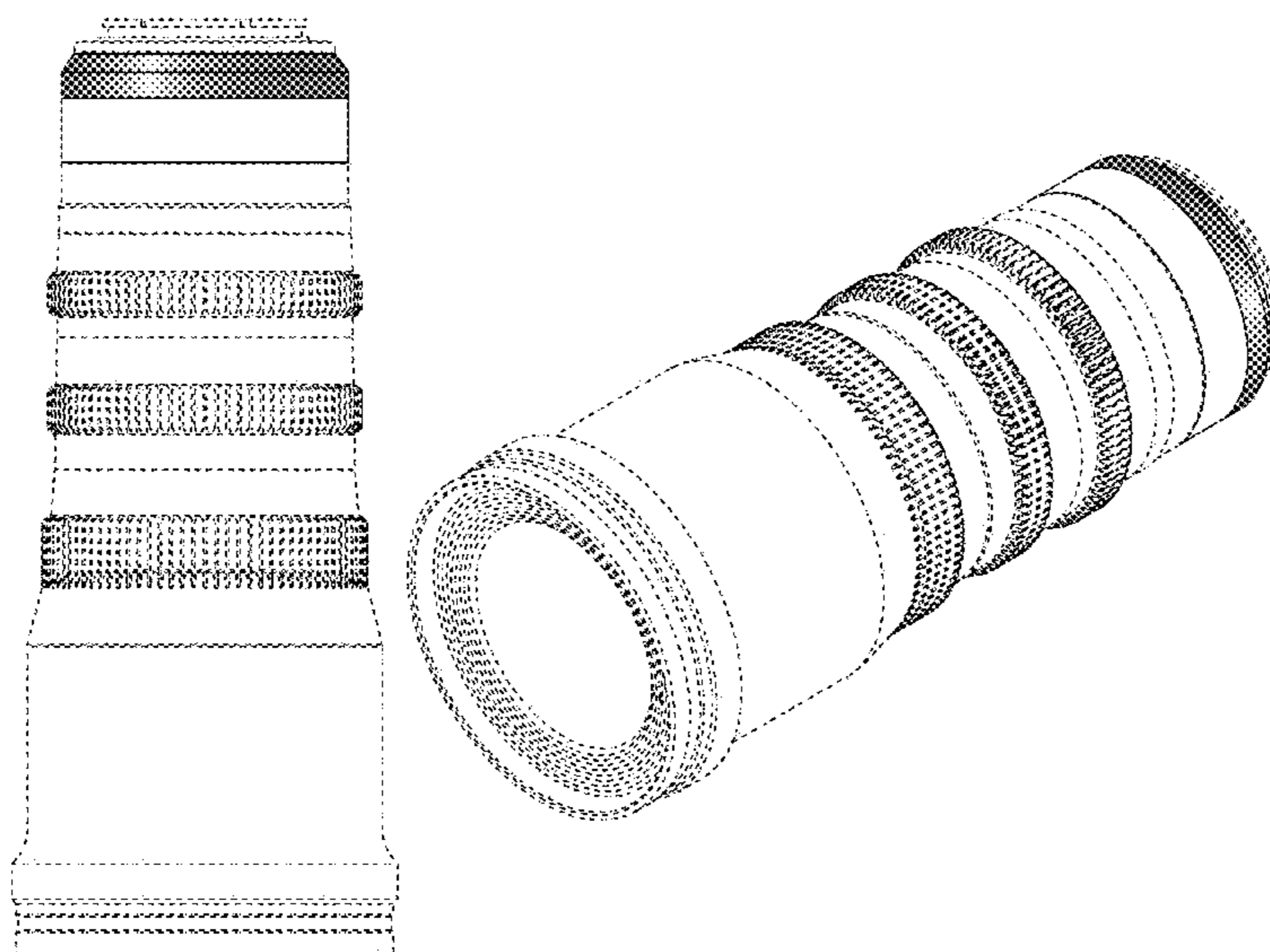

(56)

References Cited

U.S. PATENT DOCUMENTS

D310,840 S * 9/1990 Degnan D16/130
 D327,286 S 6/1992 Fukutomi
 D337,775 S 7/1993 Takahashi
 D350,395 S * 9/1994 Håkansson D24/145
 D376,568 S * 12/1996 Davidson D12/126
 D400,778 S * 11/1998 Holbrook, Jr. D8/311
 D407,985 S * 4/1999 Pimentel D10/104.2
 5,937,487 A * 8/1999 Bauer A41F 1/002
 24/303
 6,377,408 B1 4/2002 Shinohara
 D521,314 S * 5/2006 Ball D7/393
 D548,262 S 8/2007 Nakamura
 D573,167 S 7/2008 Kitera
 D649,431 S * 11/2011 Shartel D8/330
 D664,581 S * 7/2012 Palm D16/219
 D682,909 S * 5/2013 Kim 24/115 R
 D683,380 S * 5/2013 Asano D16/219
 D683,381 S * 5/2013 Asano D16/219
 D684,620 S 6/2013 Kim
 8,454,250 B2 * 6/2013 Yamamoto G02B 7/14
 396/531
 D693,869 S * 11/2013 Asano D16/219
 D697,542 S 1/2014 Kim
 D697,543 S 1/2014 Kim
 D698,844 S * 2/2014 Hasuda D16/219
 D717,356 S 11/2014 Nikaido
 D726,239 S 4/2015 So
 D730,967 S * 6/2015 O'Neill D16/219
 D736,847 S * 8/2015 Kobayashi D16/219
 D736,848 S * 8/2015 Kim D16/237
 D737,360 S 8/2015 Jung
 D737,497 S * 8/2015 Burgess D26/113
 D741,938 S 10/2015 Lee
 D742,265 S * 11/2015 Harck D10/103
 D745,916 S * 12/2015 Oh D16/134
 9,200,666 B1 * 12/2015 Cadena F16B 41/005
 D750,688 S * 3/2016 Oh D16/134
 D751,516 S * 3/2016 Oneufer D13/174
 D754,237 S * 4/2016 Oh D16/219
 D756,441 S * 5/2016 Kobayashi D16/219
 D758,228 S * 6/2016 Harck D10/101
 D763,942 S * 8/2016 Yoon D16/219
 D766,699 S * 9/2016 Vergin D8/311
 D766,844 S * 9/2016 Turksu D10/104.1
 D768,226 S 10/2016 Kawamura
 D769,696 S * 10/2016 Davis D8/330
 D775,680 S * 1/2017 Yoshiyama D16/219
 D781,364 S * 3/2017 Tagawa D16/219
 D781,949 S 3/2017 Lee
 D783,593 S * 4/2017 Chen D14/253
 9,791,660 B2 10/2017 Takeshita
 D802,404 S * 11/2017 Turksu D8/373
 9,846,350 B2 12/2017 Takeshita
 D808,767 S * 1/2018 Kim D8/311
 D812,577 S * 3/2018 Turksu D13/168

D816,148 S * 4/2018 Li D16/219
 D817,145 S * 5/2018 Kim D8/311
 D827,014 S * 8/2018 Sakai D16/218
 D836,152 S * 12/2018 Ikegame D16/219
 D842,918 S * 3/2019 Sakai D16/219
 D849,116 S * 5/2019 Lee D16/219
 D856,396 S * 8/2019 Ikegame D16/219
 D929,490 S * 8/2021 Miyazawa D16/219
 D932,536 S * 10/2021 Yoon D16/219
 D936,725 S * 11/2021 Takano D16/219
 2003/0189771 A1 10/2003 Takeda
 2007/0166028 A1 7/2007 Kranz
 2014/0178060 A1 6/2014 Saita
 2014/0369674 A1 12/2014 Neff
 2015/0062408 A1 3/2015 Yano
 2015/0355434 A1 12/2015 Matsumoto
 2016/0227099 A1 8/2016 Hansen
 2016/0299413 A1 10/2016 Fee
 2017/0199347 A1 7/2017 Takeshita
 2017/0351051 A1 12/2017 Kawamura

OTHER PUBLICATIONS

12L14 Carbon Steel Flat Washer, published Nov. 22, 2013 [online], [retrieved Jan. 18, 2018], Available from Internet, URL: <<https://www.amazon.com/12L14-Carbon-Steel-Washer-Finish/dp/B00DHV8VR8>>.*
 6mm Bevel Edge Tungsten Ring with Brush Finish, published 2018 [online], [retrieved Jan. 18, 2018], Available from Internet, URL: <https://www.e-weddingbands.com/store/beveled_tungsten_rings.html>.*
 Grade 18-8 Stainless Steel Beveled Round Flat Washer, published 2019 [online], [retrieved Jan. 18, 2018], Available from Internet, URL: <<https://www.msdirect.com/product/details/06795892>>.*
 Female I-Line Solid End Caps, published 2018 [online], [retrieved Jan. 18, 2018], Available from Internet, URL: <<https://www.hosexpress.com/female-i-line-solid-end-caps.html>>.*
 Plain Bevel Seat Tapped Thermometer Caps, in production since 1986, [online], [retrieved Jan. 18, 2018], Available from Internet, URL: <https://www.austenitex.com/shop_by_brand/Bevel-Seat-End-Caps/Plain-Bevel-Seat-Tapped-Thermometer-Caps>.*
 Best Telephoto Lenses for Canon DSLRS posted to cameraegg.org. Available date: Oct. 23, 2014 [site visited Dec. 8, 2021] Available: <<https://www.cameraegg.org/best-telephoto-lenses-for-canon-dslrs/>> (Year: 2014).*
 Walkaround Guys: 5 Best Everyday Kit Lenses by Chris Gampat, posted to gearpatrol.com. Available date: Jun. 12, 2013 [site visited Dec. 8, 2021] Available: <<https://www.gearpatrol.com/tech/a72258/5-best-everyday-kit-lenses/>> (Year: 2013).*
 Notification of Reasons for Rejection for JP 2016-017868, dated Jan. 31, 2017.

* cited by examiner

FIG. 1

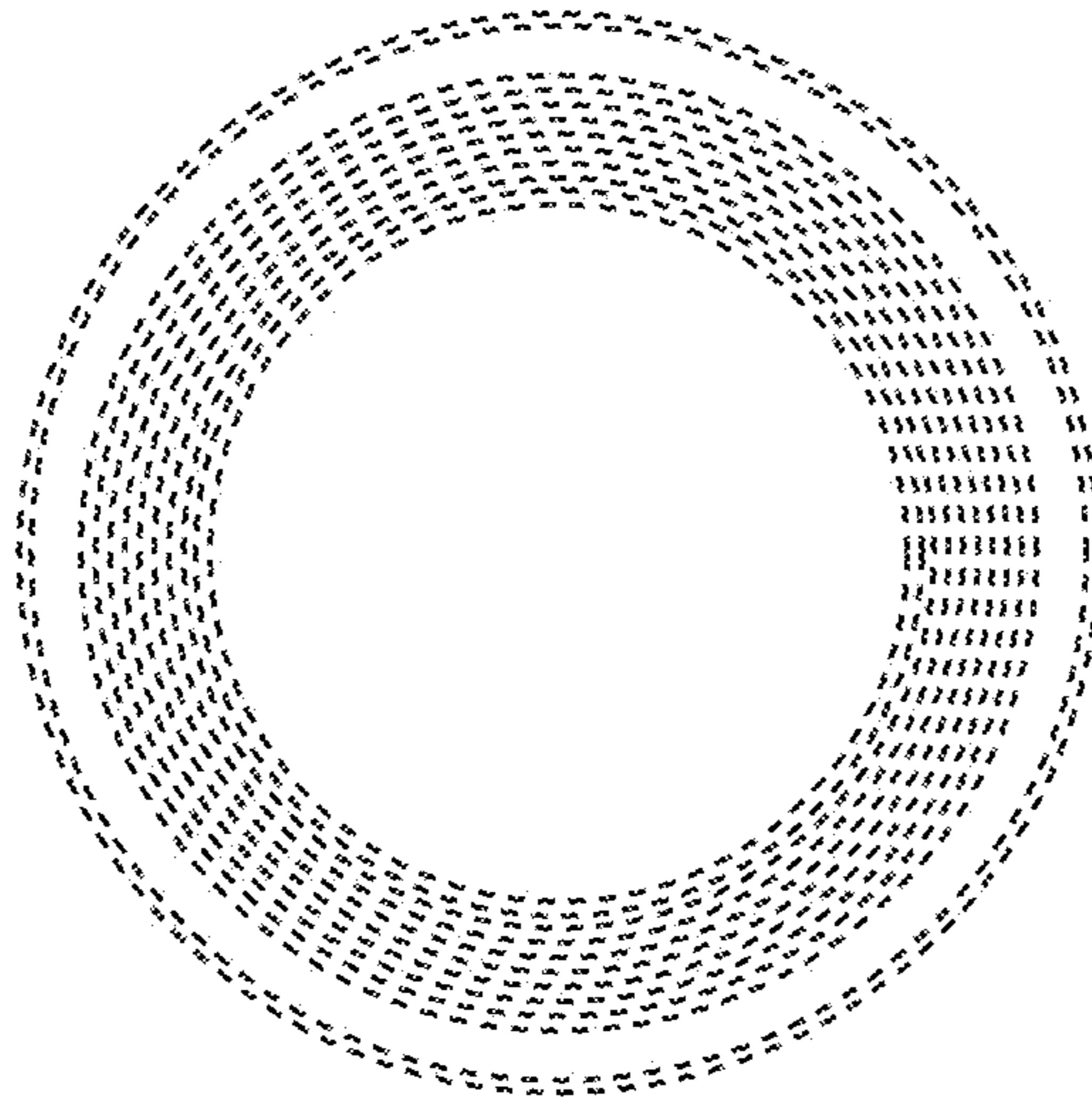

FIG. 2

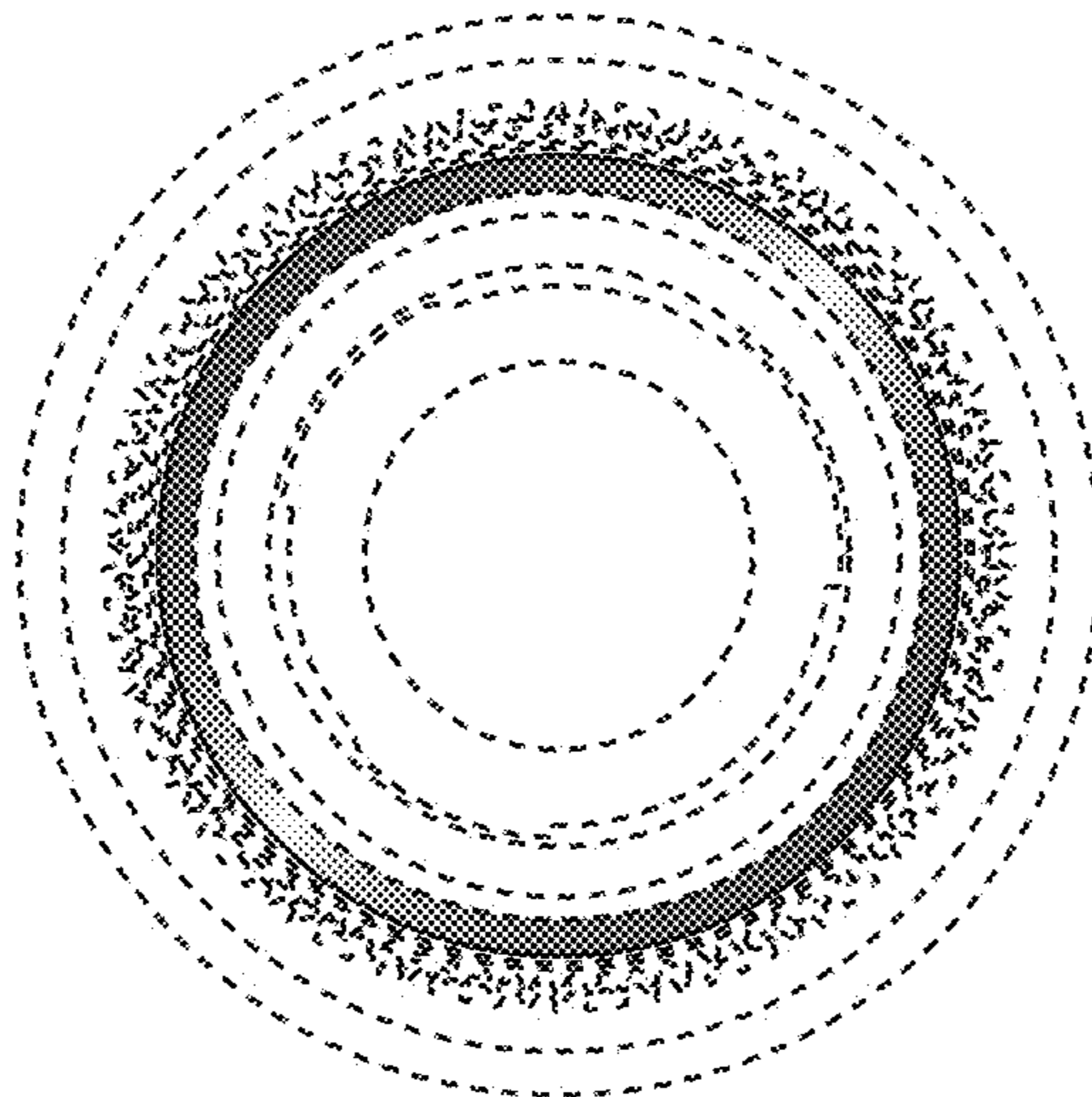

FIG. 3

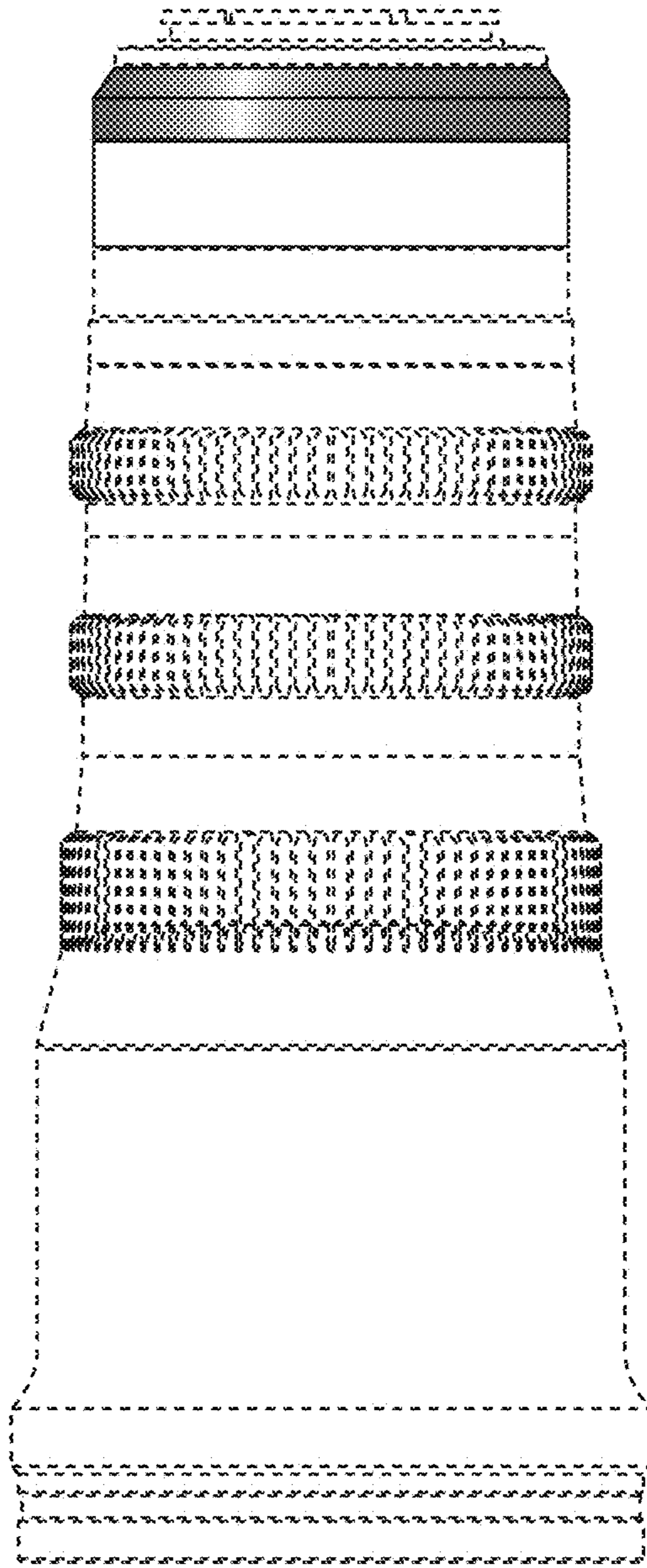

FIG. 4

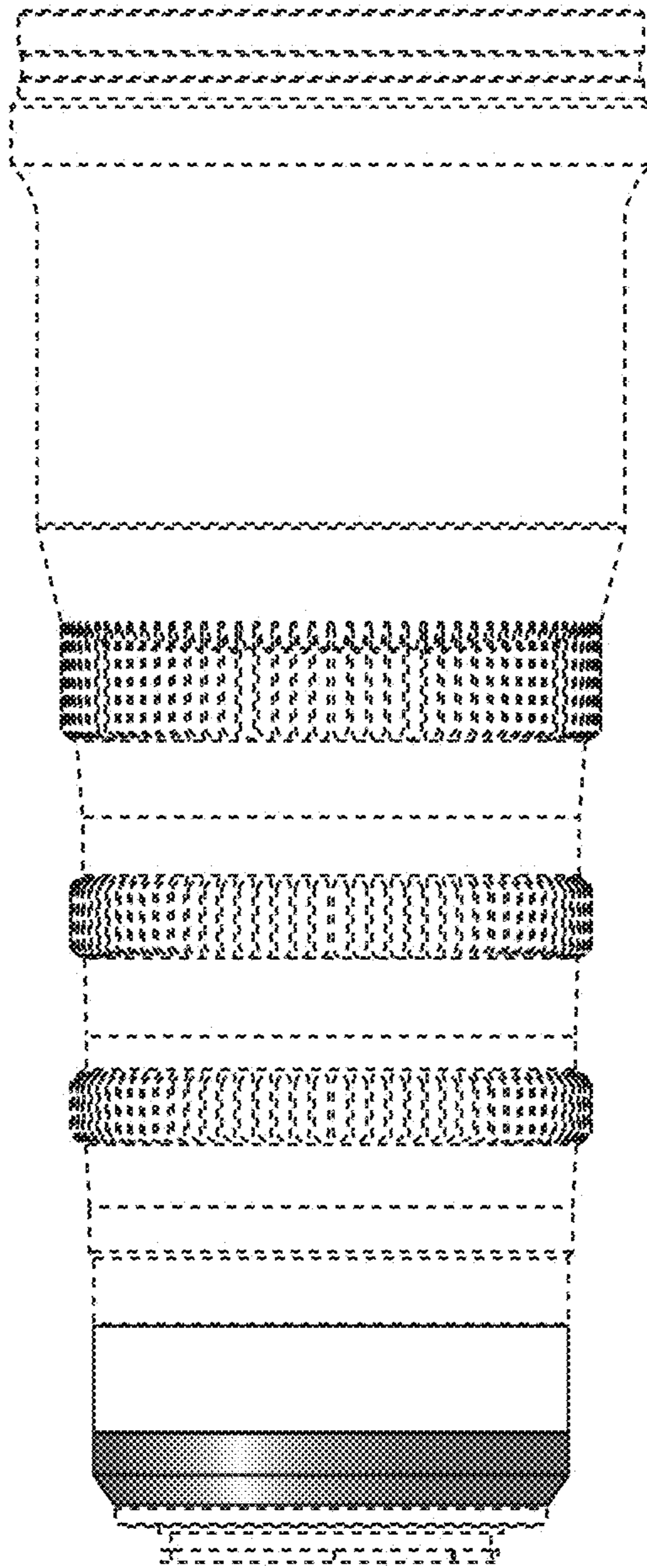

FIG. 5

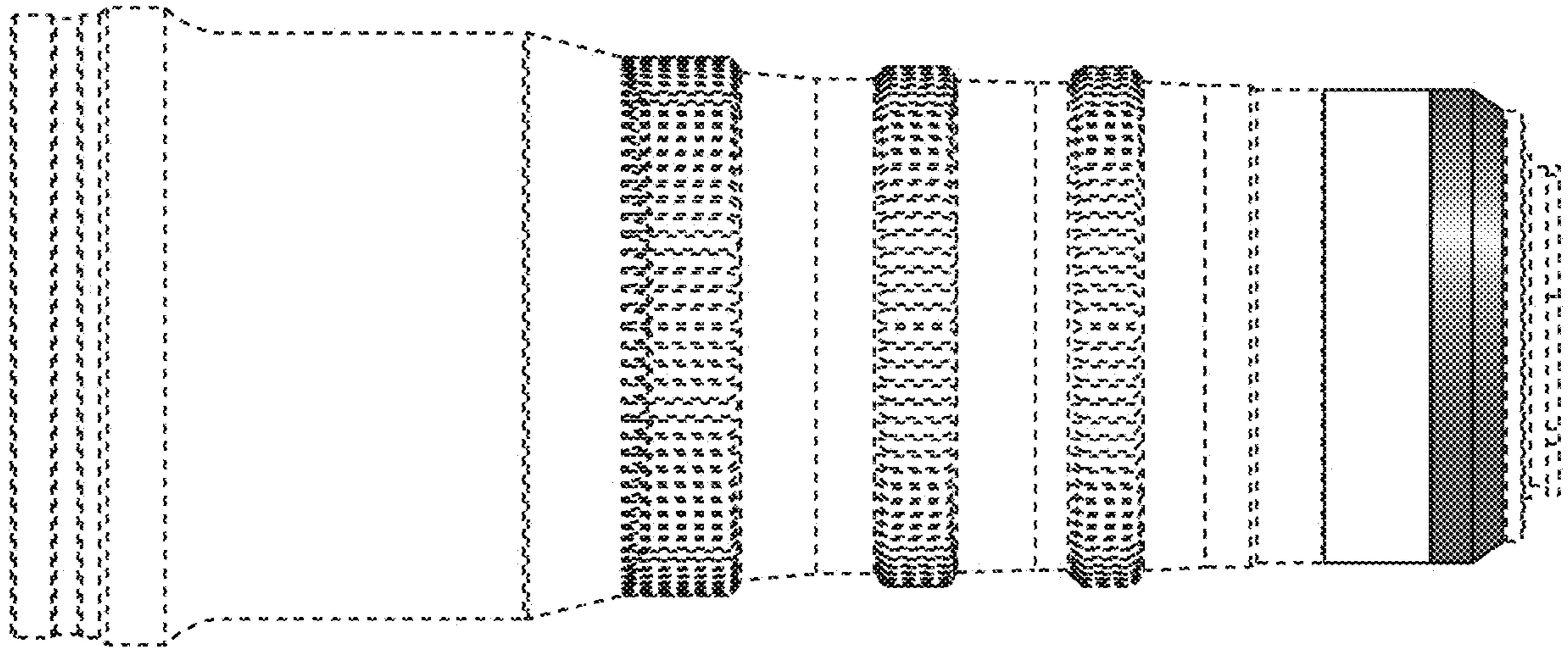

FIG. 6

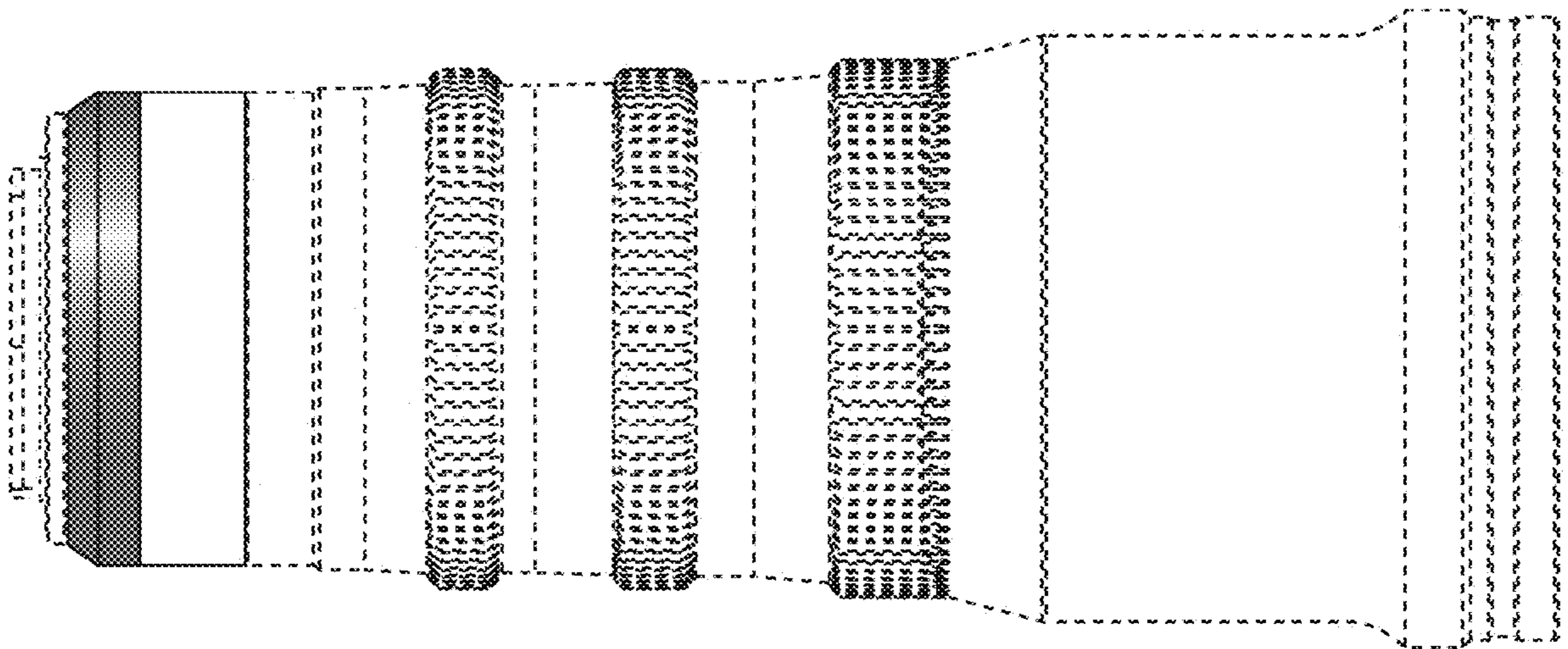

FIG. 7

