

US00D949837S

(12) **United States Design Patent**  
**Lee**

(10) **Patent No.:** **US D949,837 S**  
(45) **Date of Patent:** **\*\* Apr. 26, 2022**

(54) **STAND FOR A TV RECEIVER**

(71) Applicant: **LG ELECTRONICS INC.**, Seoul  
(KR)

(72) Inventor: **Nari Lee**, Seoul (KR)

(73) Assignee: **LG ELECTRONICS INC.**, Seoul  
(KR)

(\*\*) Term: **15 Years**

(21) Appl. No.: **29/751,536**

(22) Filed: **Sep. 22, 2020**

(30) **Foreign Application Priority Data**

Apr. 9, 2020 (KR) ..... 30-2020-0015921

(51) **LOC (13) Cl.** ..... **14-03**

(52) **U.S. Cl.**  
USPC ..... **D14/239**

(58) **Field of Classification Search**  
USPC ..... D14/239, 371, 372-374, 447-452, 125,  
D14/127-129, 335-337, 375-377, 341,  
D14/126, 211, 238, 447-448; D8/355,  
D8/363, 373, 380, 366, 376, 377, 354;  
D6/672, 682, 553, 300, 310-313, 308,  
D6/708; D25/121, 119

CPC ..... F16M 11/2085; F16M 11/2092; F16M  
11/2007; F16M 11/2014; F16M 11/2021;  
F16M 11/105; F16M 11/10; F16M  
11/048; F16M 11/12; F16M 13/022;  
F16M 13/02; F16M 13/00; F16M 11/04;  
F16M 2200/08; H04N 5/655; H02G  
3/126; A47B 21/0314; A47B 88/044;  
A47B 21/0335; A47G 1/17; A47K  
2201/001; F16B 47/00; F16B 47/006

See application file for complete search history.

(56) **References Cited**

**U.S. PATENT DOCUMENTS**

D587,251 S \* 2/2009 Morello ..... D14/239  
D635,874 S \* 4/2011 Tseng ..... D10/70

D640,692 S \* 6/2011 Waisman-Diamond ..... D14/358  
D691,149 S \* 10/2013 Breton ..... D14/447  
D693,248 S \* 11/2013 Anderssen ..... D10/65  
D715,277 S \* 10/2014 Kim ..... D14/239

(Continued)

**OTHER PUBLICATIONS**

AlCase Tablet Floor Stand Gooseneck Tablet Holder Mount, first available Aug. 21, 2020, amazon.co.uk, [online], [site visited Dec. 15, 2021], Available from internet URL: [https://www.amazon.co.uk/dp/B08GCHPYY9/ref=sspa\\_dk\\_detail\\_5?psc=1&pd\\_rd\\_i=B08GCHPYY9&pd\\_rd\\_w=msGMb&pf\\_rd\\_p=828203ef-618e-4303%E2%80%A6](https://www.amazon.co.uk/dp/B08GCHPYY9/ref=sspa_dk_detail_5?psc=1&pd_rd_i=B08GCHPYY9&pd_rd_w=msGMb&pf_rd_p=828203ef-618e-4303%E2%80%A6) (Year: 2020).\*

HITRENDS Cell Phone Stand, Tablet Holder, first available Apr. 21, 2020, amazon.co.uk, [online], [site visited Dec. 15, 2021], Available from internet URL: [https://www.amazon.co.uk/dp/B087GHF4M8/ref=sspa\\_dk\\_detail\\_6?pd\\_rd\\_w=uG96q&pf\\_rd\\_p=a8d38b47-cfdf-4208-95a0-1af779cb6e7d&pd\\_rd\\_wg=1%E2%80%A6&th=1](https://www.amazon.co.uk/dp/B087GHF4M8/ref=sspa_dk_detail_6?pd_rd_w=uG96q&pf_rd_p=a8d38b47-cfdf-4208-95a0-1af779cb6e7d&pd_rd_wg=1%E2%80%A6&th=1) (Year: 2020).\*

(Continued)

*Primary Examiner* — Samantha Q Lawrence

*Assistant Examiner* — Holly M Rodriguez

(74) *Attorney, Agent, or Firm* — Birch, Stewart, Kolasch & Birch, LLP

(57) **CLAIM**

The ornamental design for a stand for a TV receiver, as shown and described.

**DESCRIPTION**

FIG. 1 is a front, right side, perspective view of a stand for a TV receiver showing our new design;

FIG. 2 is a front view thereof;

FIG. 3 is a rear view thereof;

FIG. 4 is a left side view thereof;

FIG. 5 is a right side view thereof;

FIG. 6 is a top view thereof;

FIG. 7 is a bottom view thereof; and,

FIG. 8 is a reference view that shows a state of use in which a TV receiver is combined with a stand.

The broken lines shown in FIGS. 8 illustrate environmental structure and form no part of the claimed design.

**1 Claim, 7 Drawing Sheets**

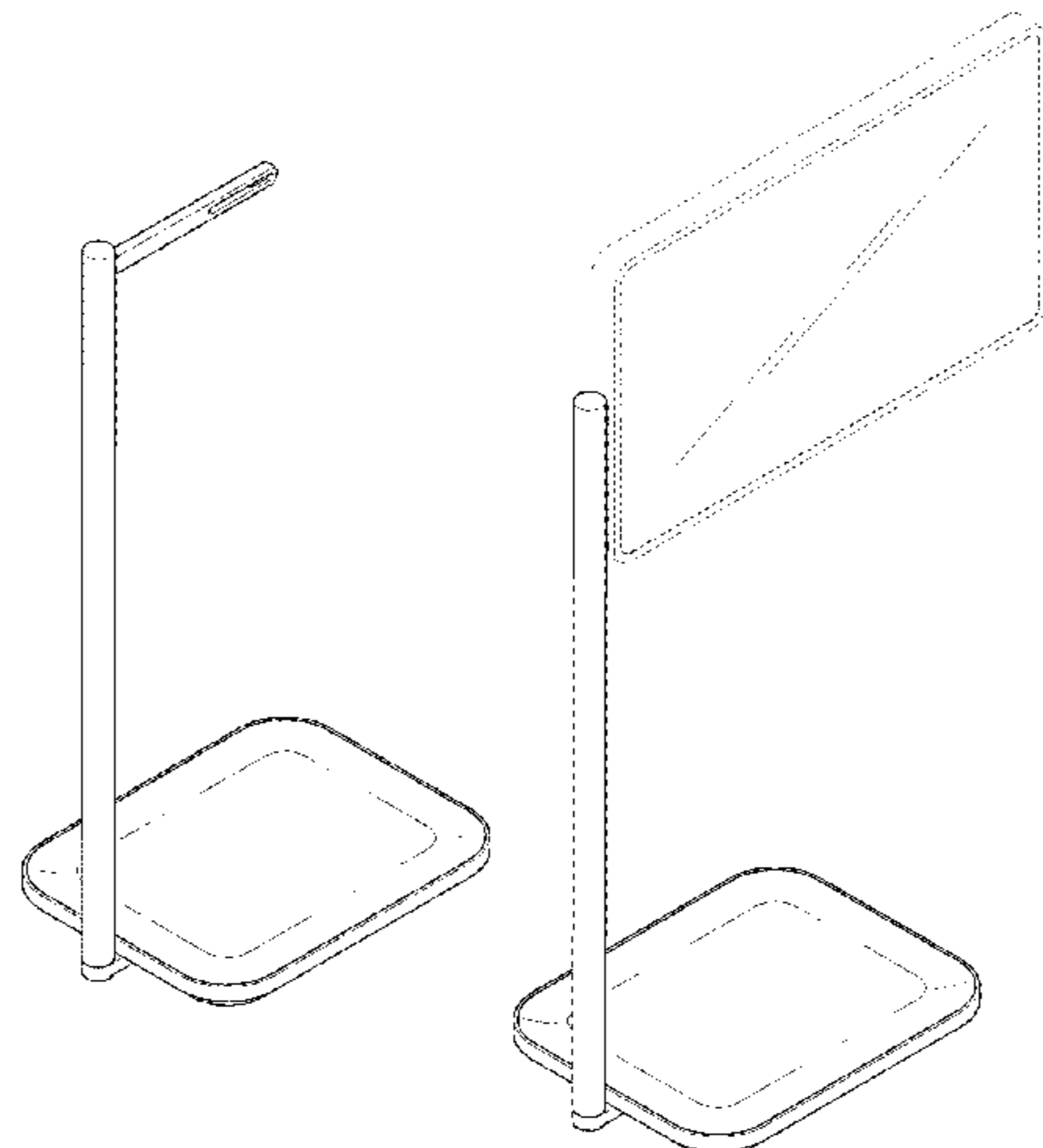

(56)

**References Cited**

## U.S. PATENT DOCUMENTS

D723,011 S \* 2/2015 Symons ..... D14/224  
D724,072 S \* 3/2015 Jiang ..... D14/253  
D762,650 S \* 8/2016 Dang ..... D14/434  
D769,234 S \* 10/2016 Rami ..... D14/253  
D783,000 S \* 4/2017 Koo ..... D14/209.1  
D789,099 S \* 6/2017 Gorman ..... D6/312  
D790,868 S \* 7/2017 Gorman ..... D6/310  
D808,965 S \* 1/2018 Bergeron-Mirsky ..... D14/371  
D824,346 S \* 7/2018 Kim ..... D14/125  
D884,711 S \* 5/2020 Zhang ..... D14/447  
D920,981 S \* 6/2021 Zhang ..... D14/434  
D928,703 S \* 8/2021 Liao ..... D13/108  
D934,234 S \* 10/2021 Deng ..... D14/253

## OTHER PUBLICATIONS

Tablet Floor Stand with Flexible Gooseneck, first available Jul. 20, 2020, amazon.co.uk/, [online], [site visited Dec. 15, 2021], Available from internet URL: [https://www.amazon.co.uk/Tablet-Flexible-Gooseneck-Adjustable-Roating-White/dp/B094ZF7BPS/ref=pd\\_sbs\\_6/257-3316196-655121\\_5?pd\\_rd\\_w=a3h%E2%80%A6](https://www.amazon.co.uk/Tablet-Flexible-Gooseneck-Adjustable-Roating-White/dp/B094ZF7BPS/ref=pd_sbs_6/257-3316196-655121_5?pd_rd_w=a3h%E2%80%A6) (Year: 2020).\*

Tounee Tablet Stand and Holder for Desk, first available Nov. 27, 2020, amazon.com, [online], [site visited Dec. 15, 2021], Available from internet URL: [https://www.amazon.co.uk/dp/B08L4SYFSL/ref=sspa\\_dk\\_detail\\_4?pd\\_rd\\_w=msGMb&pf\\_rd\\_p=828203ef-618e-4303-a028-460d6b615038&pd\\_rd\\_w%E2%80%A6=undefined&th=1](https://www.amazon.co.uk/dp/B08L4SYFSL/ref=sspa_dk_detail_4?pd_rd_w=msGMb&pf_rd_p=828203ef-618e-4303-a028-460d6b615038&pd_rd_w%E2%80%A6=undefined&th=1) (Year: 2020).\*

\* cited by examiner

FIG. 1

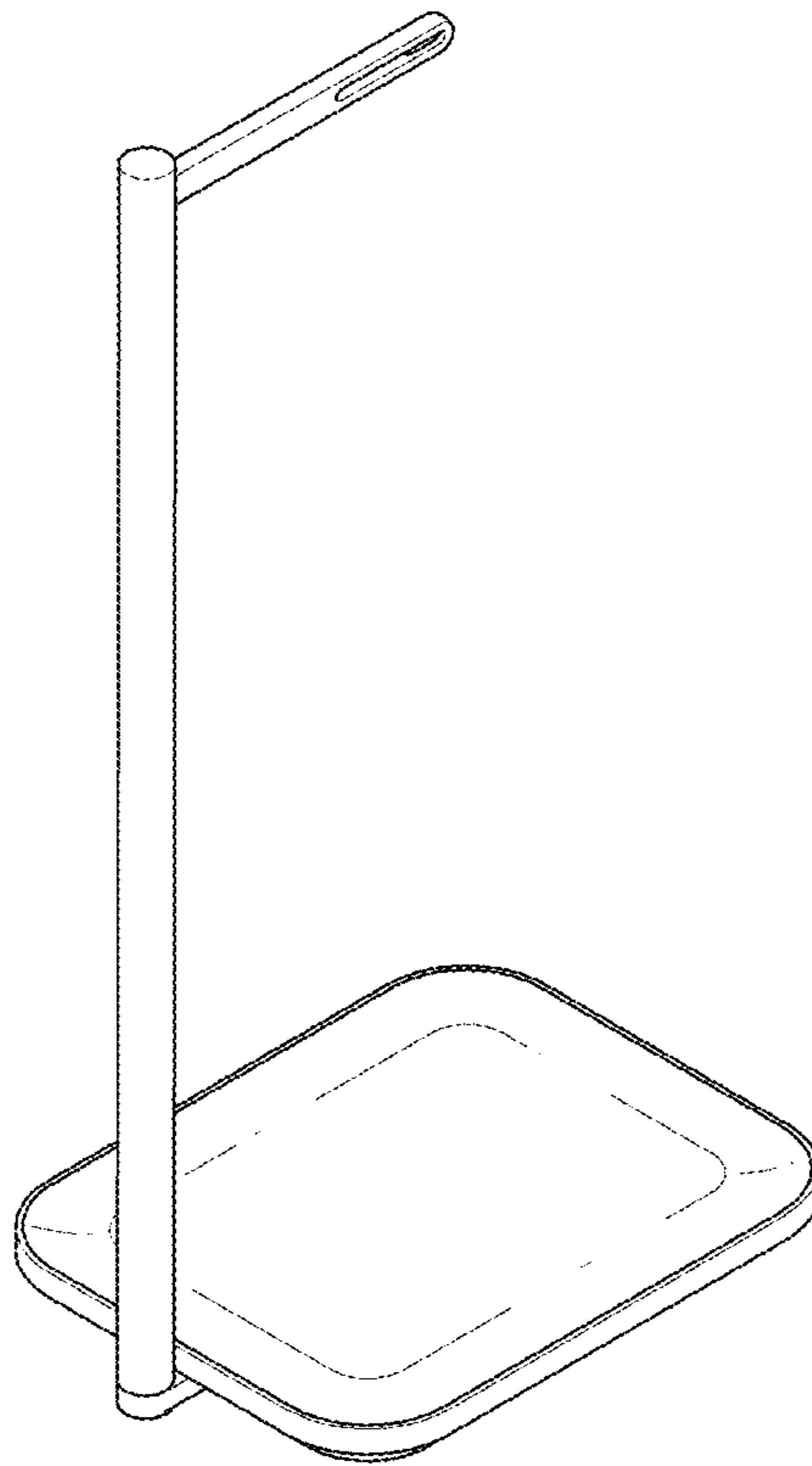

FIG. 2

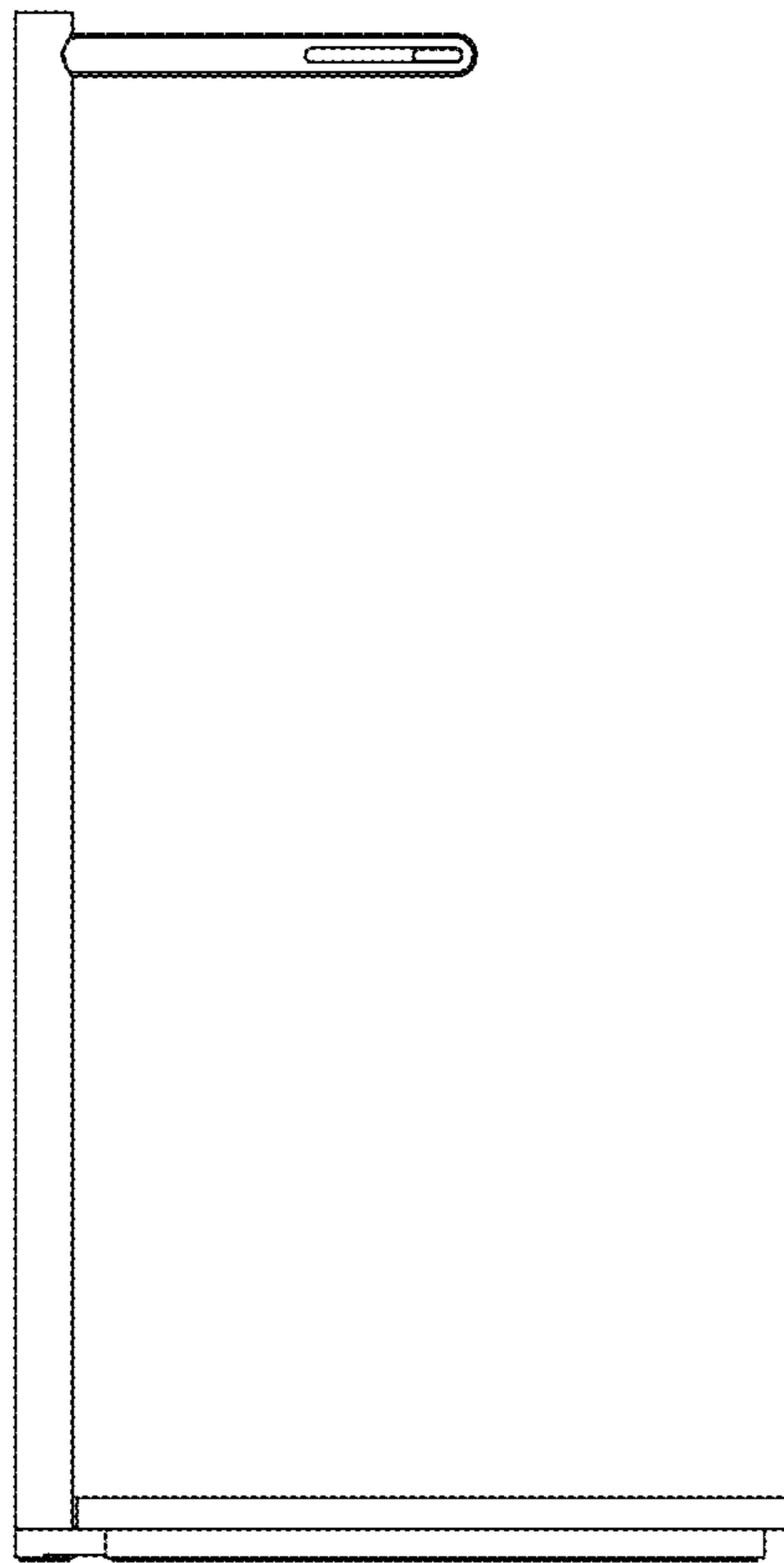

FIG. 3

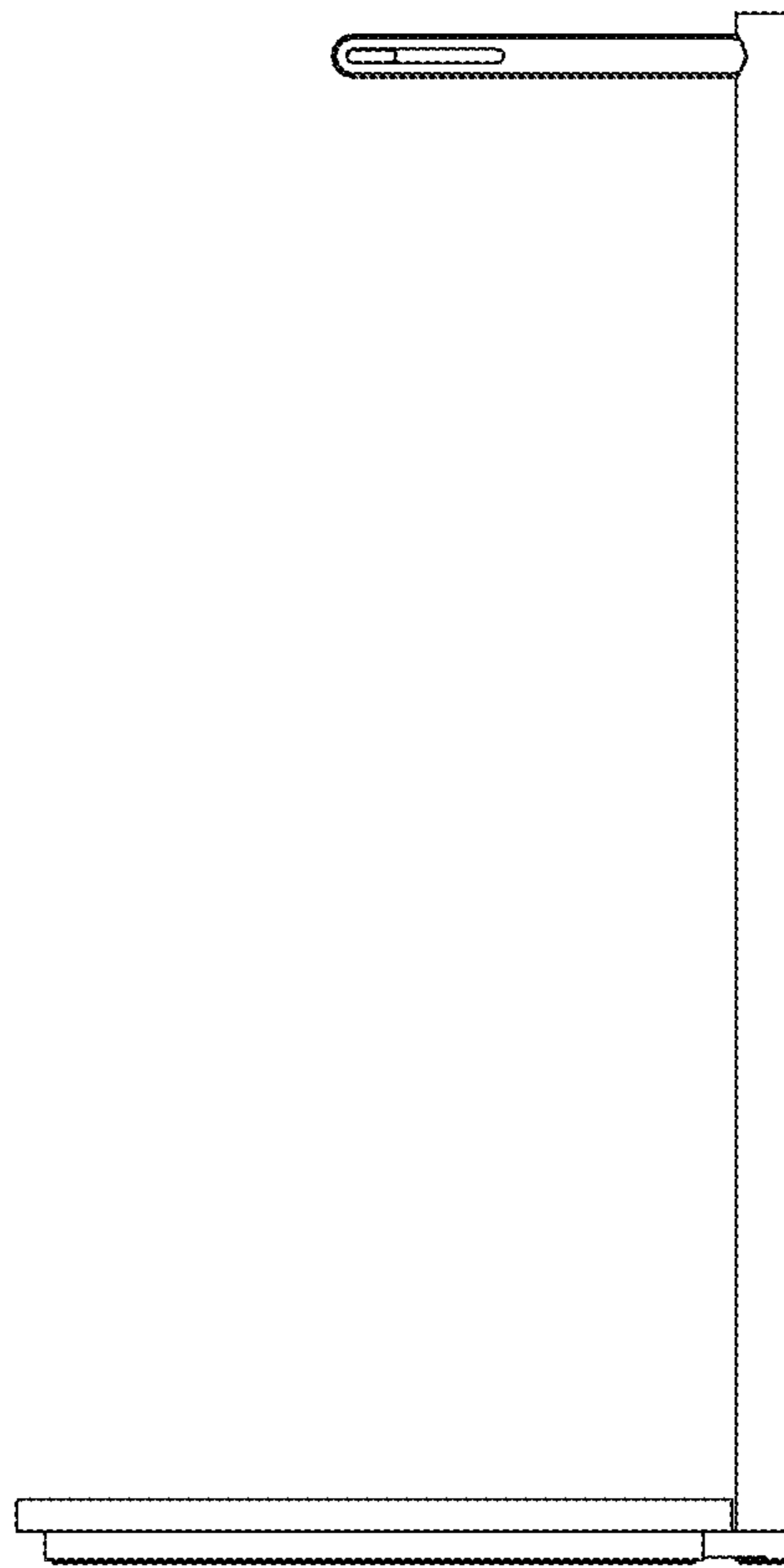

FIG. 4

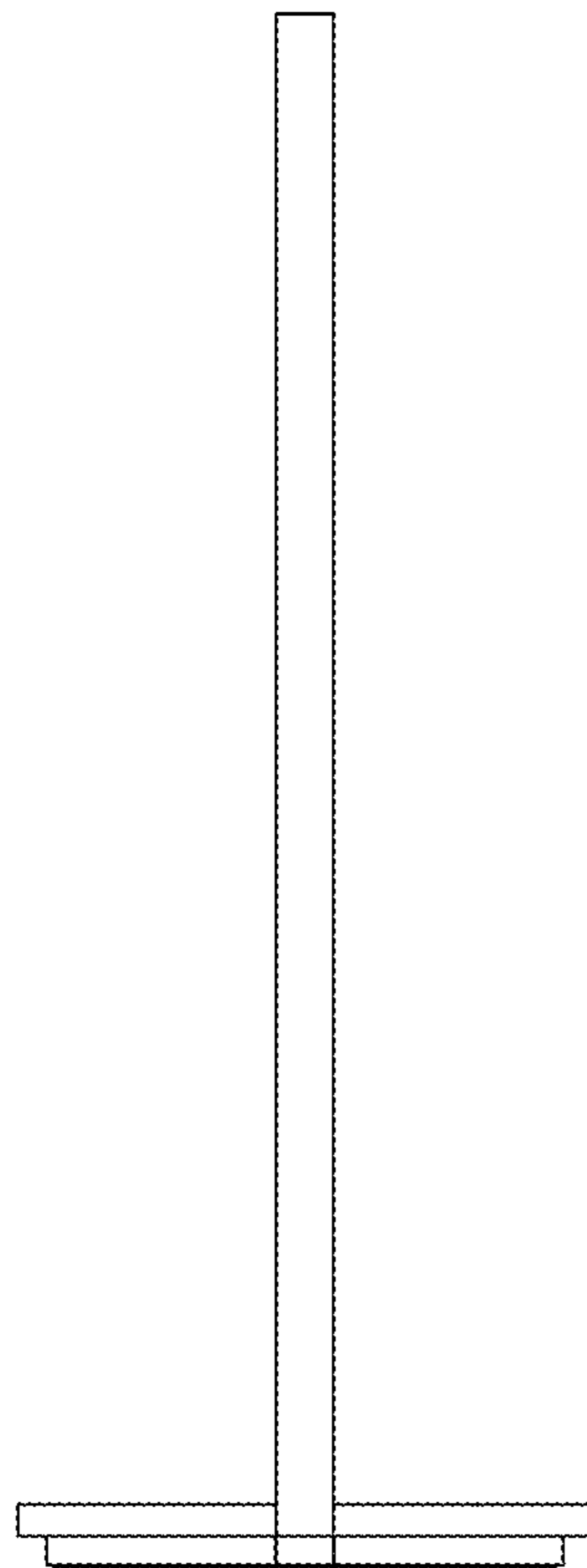

FIG. 5

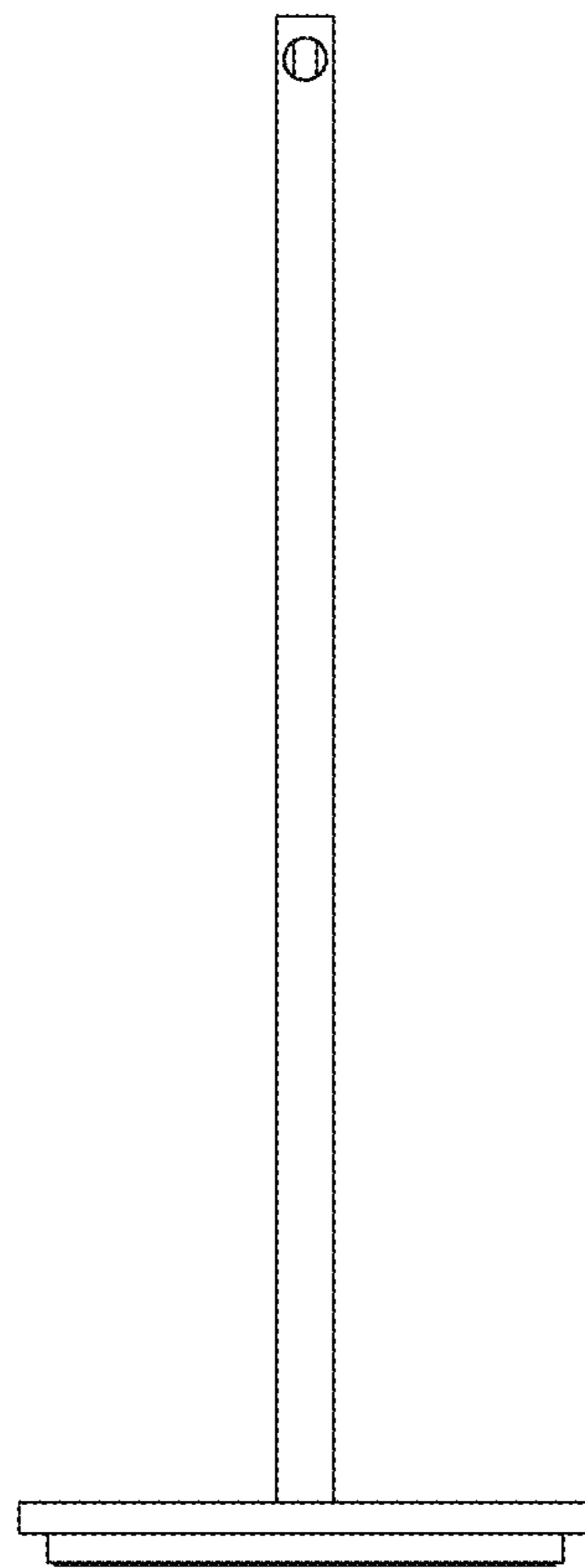

FIG. 6

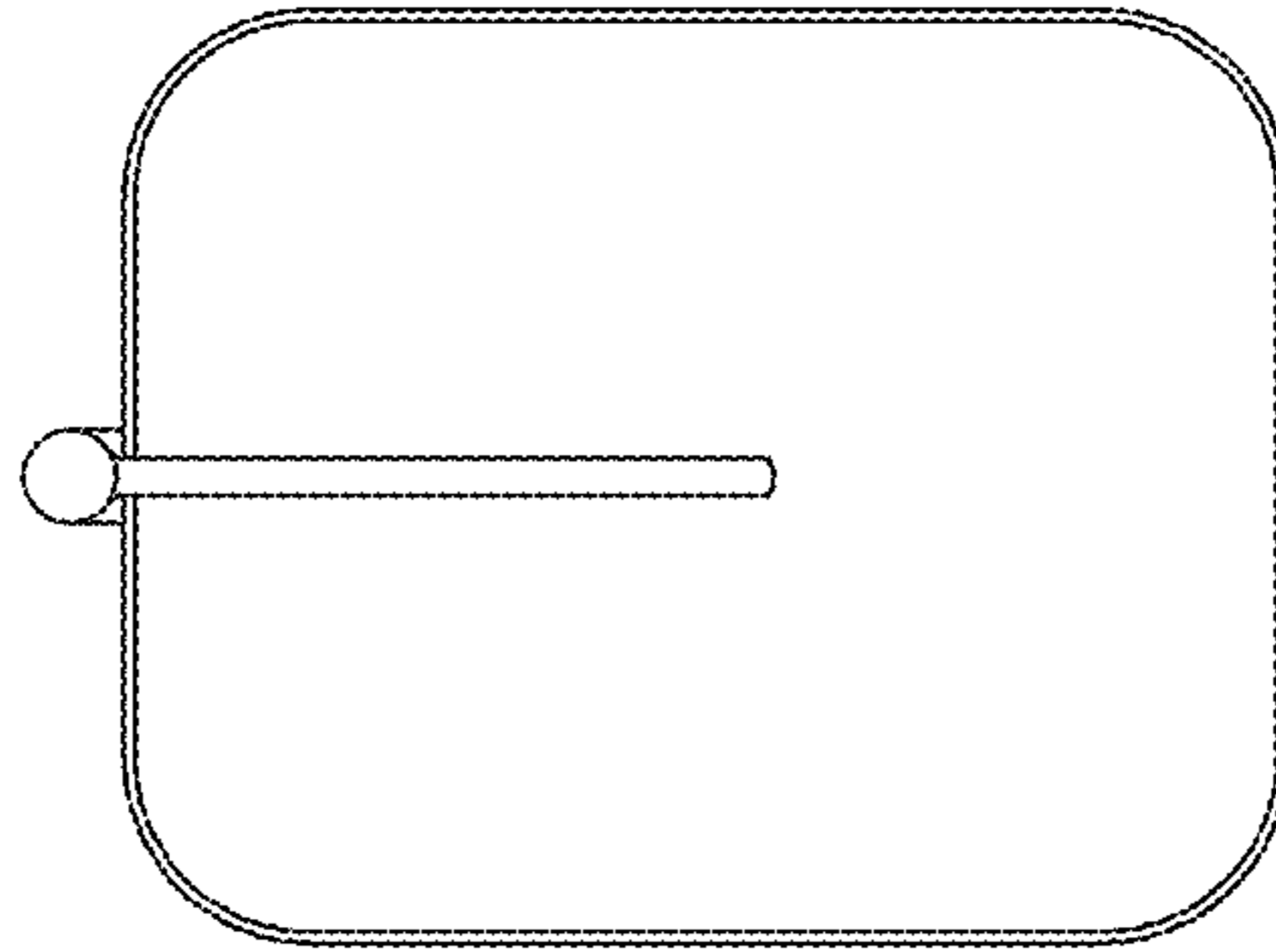

FIG. 7

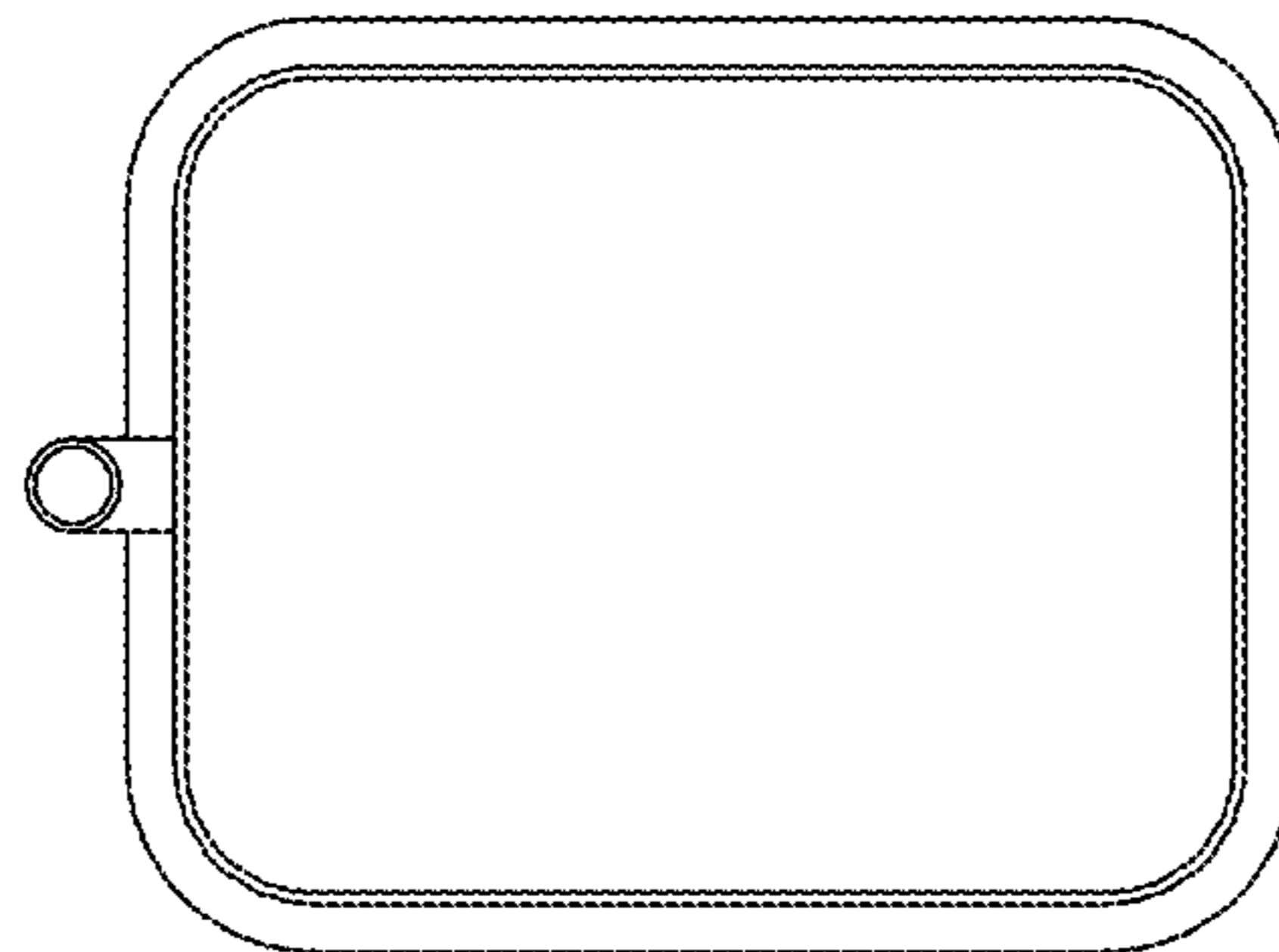



FIG. 8

