



US00D949700S

(12) **United States Design Patent**
Hsiao et al.

(10) **Patent No.:** **US D949,700 S**
(45) **Date of Patent:** **** Apr. 26, 2022**

(54) **BOTTLE FOR OLIVE OIL**

(71) Applicant: **Stanislaus Food Products Company**,
Modesto, CA (US)

(72) Inventors: **Amy Hsiao**, Modesto, CA (US); **Brady Whitlow**, Stockton, CA (US)

(73) Assignee: **STANISLAUS FOOD PRODUCTS COMPANY**, Modesto, CA (US)

(**) Term: **15 Years**

(21) Appl. No.: **29/717,036**

(22) Filed: **Dec. 13, 2019**

(51) **LOC (13) Cl.** **09-01**

(52) **U.S. Cl.**

USPC **D9/544; D9/560**

(58) **Field of Classification Search**

USPC D9/520, 544, 545, 556, 559-561, 563,
D9/569, 573-575, 550, 546; D7/598;
D11/143

CPC B65D 1/0223; B65D 1/0276; B65D
2501/0081; B65D 81/3806; B65D
81/3818

See application file for complete search history.

(56) **References Cited**

U.S. PATENT DOCUMENTS

D44,881 S * 11/1913 Alexander D9/560
D93,412 S * 9/1934 Kessler D9/560
D207,803 S * 5/1967 Du D9/560
D346,227 S * 4/1994 Boss D26/11

(Continued)

OTHER PUBLICATIONS

Peter Walla, Jul. 2012, ResearchGate.net | Bottle Shape Elicits Gender-Specific Emotion: A Startle Reflex Modulation Study, URL: https://www.researchgate.net/figure/Bottles-Short-pyramid-shaped-1-tall-with-parallel-edges-2-and-tall-pyramid-shaped_fig1_233721798 (Year: 2012).*

Primary Examiner — Brett Miller

Assistant Examiner — Rani J Abdallah

(74) *Attorney, Agent, or Firm* — Orrick, Herrington & Sutcliffe LLP

(57) **CLAIM**

The ornamental design for a bottle for olive oil, as shown and described.

DESCRIPTION

FIG. 1 is a perspective view illustrating an embodiment of our new and ornamental design for a bottle for olive oil, wherein the bottle includes decorative indicia; FIG. 2 is a top view illustrating the new and ornamental design for the bottle of FIG. 1; FIG. 3 is a bottom view illustrating the new and ornamental design for the bottle of FIG. 1; FIG. 4 is a back view illustrating the new and ornamental design for the bottle of FIG. 1; FIG. 5 is a front view illustrating the new and ornamental design for the bottle of FIG. 1; FIG. 6 is a right-side view illustrating the new and ornamental design for the bottle of FIG. 1; FIG. 7 is a left-side view illustrating the new and ornamental design for the bottle of FIG. 1; FIG. 8 is a perspective view illustrating an alternative embodiment of the new and ornamental design for the bottle of FIGS. 1-7, wherein the bottle comprises a transparent material; FIG. 9 is a top view illustrating the new and ornamental design for the bottle of FIG. 8; FIG. 10 is a bottom view illustrating the new and ornamental design for the bottle of FIG. 8; FIG. 11 is a back view illustrating the new and ornamental design for the bottle of FIG. 8; FIG. 12 is a front view illustrating the new and ornamental design for the bottle of FIG. 8; FIG. 13 is a right-side view illustrating the new and ornamental design for the bottle of FIG. 8; and, FIG. 14 is a left-side view illustrating the new and ornamental design for the bottle of FIG. 8.

1 Claim, 12 Drawing Sheets

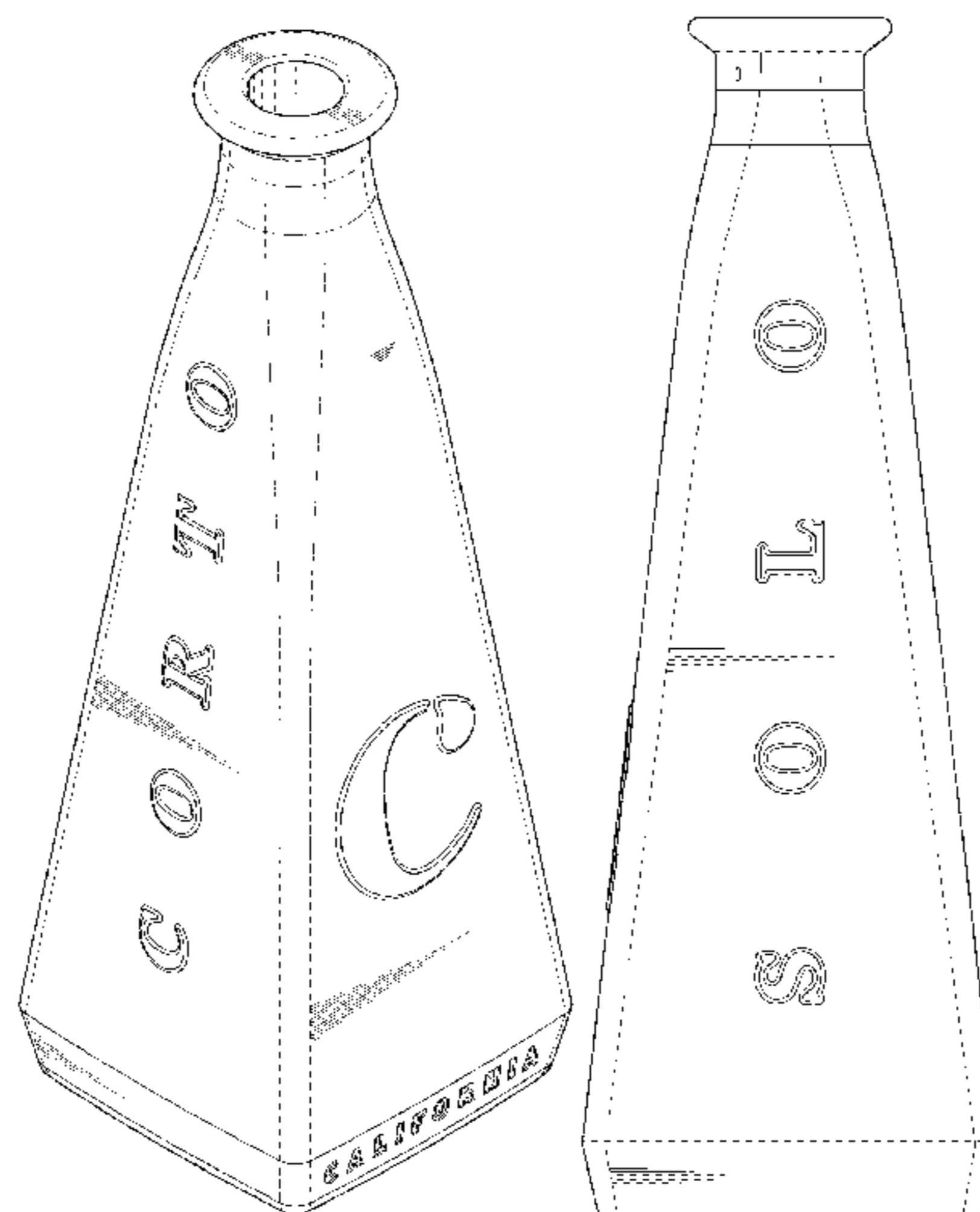

(56)

References Cited

U.S. PATENT DOCUMENTS

D380,966	S	*	7/1997	Frazer	D9/560
D545,685	S	*	7/2007	Henderson	D9/560
D546,701	S	*	7/2007	Henderson	D9/560
D550,094	S	*	9/2007	Henderson	D9/560
D567,664	S	*	4/2008	Rica	D9/544
D573,892	S	*	7/2008	Moretti	D9/560
D573,893	S	*	7/2008	Moretti	D9/560
D579,783	S	*	11/2008	Katcher	D9/544
D584,953	S	*	1/2009	Rica	D9/560
D586,661	S	*	2/2009	Sherman	D9/560
D594,343	S	*	6/2009	Leruste	D9/560
D653,553	S	*	2/2012	Sanghavi	D9/560
D757,559	S	*	5/2016	Sanghavi	D9/560
D793,240	S	*	8/2017	Pensler	D9/560
D796,336	S	*	9/2017	Pensler	D9/560
D804,953	S	*	12/2017	Sanghavi	D9/560
D867,154	S	*	11/2019	Sanghavi	D9/560
D873,146	S	*	1/2020	Nechita	D9/560
D929,235	S	*	8/2021	Tarashchansky	D9/544

* cited by examiner

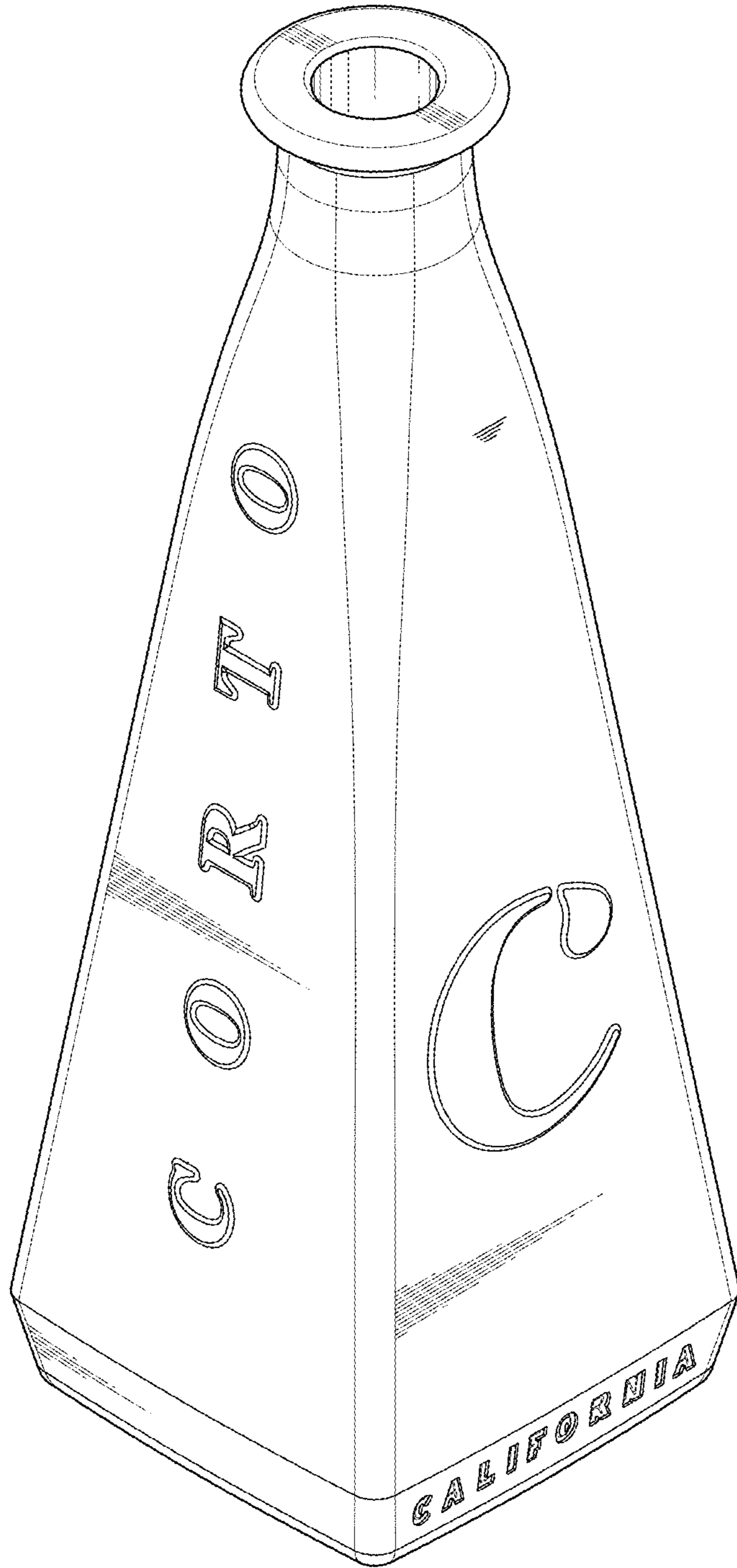

FIG. 1

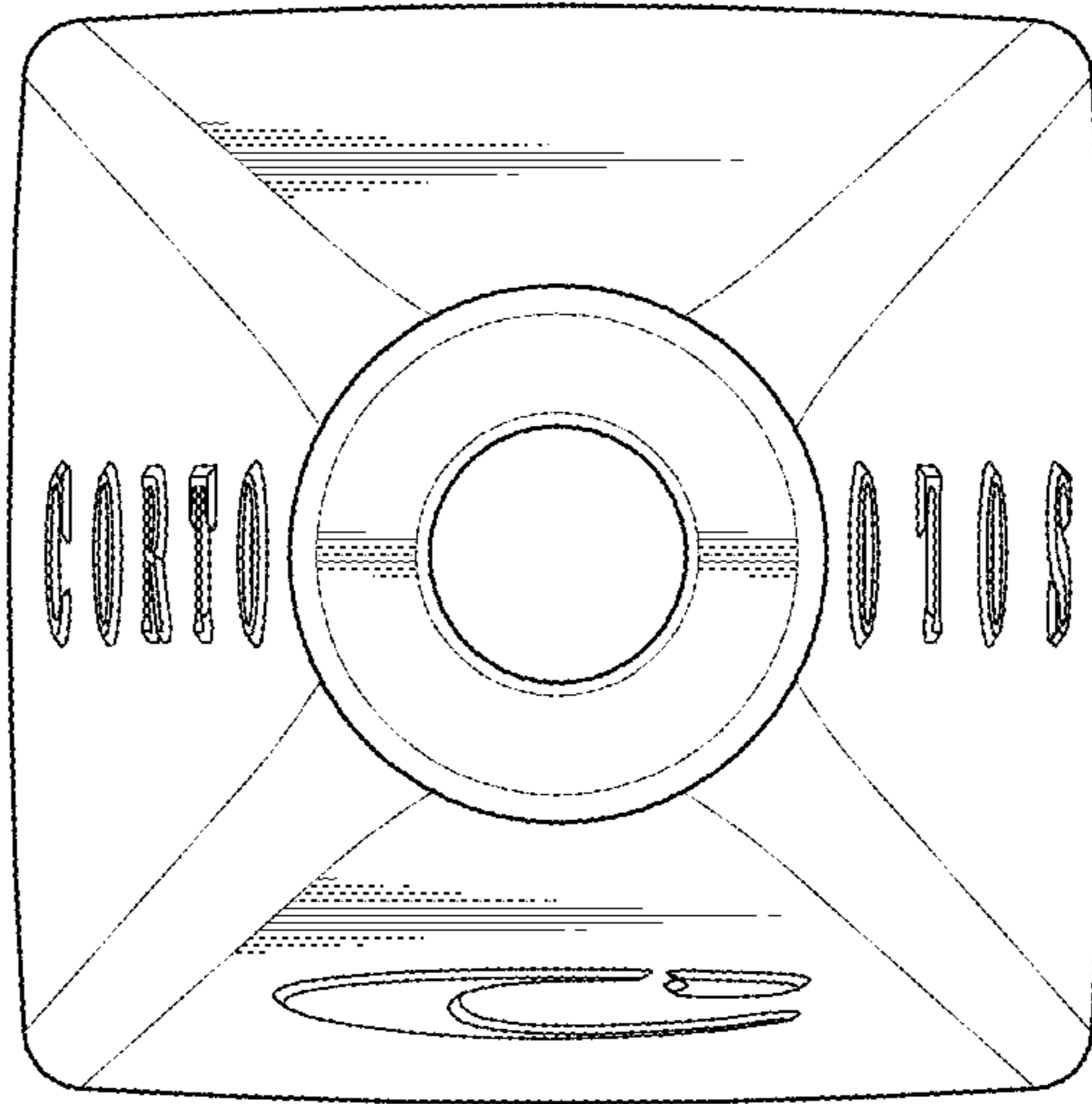

FIG. 2

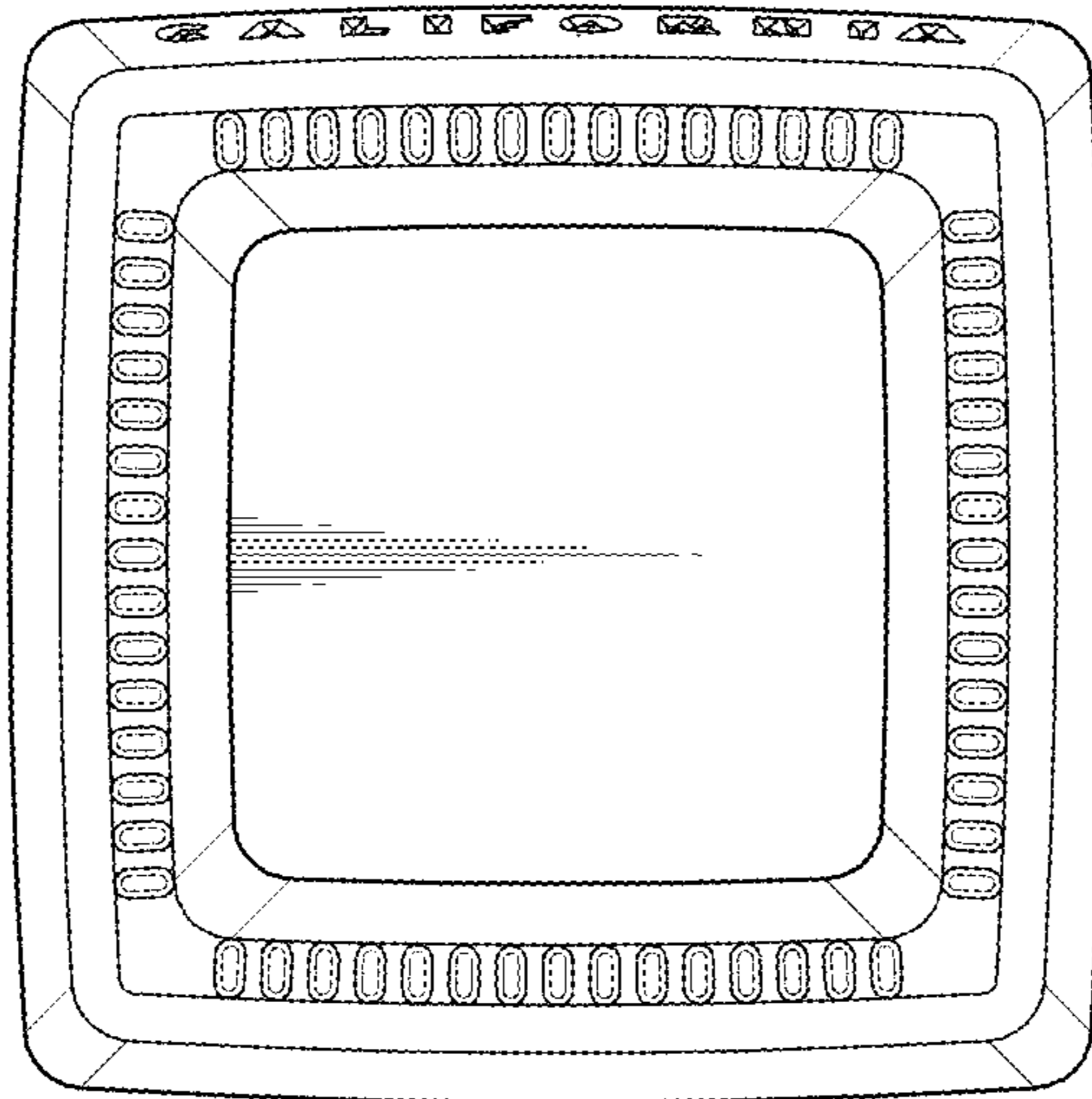

FIG. 3

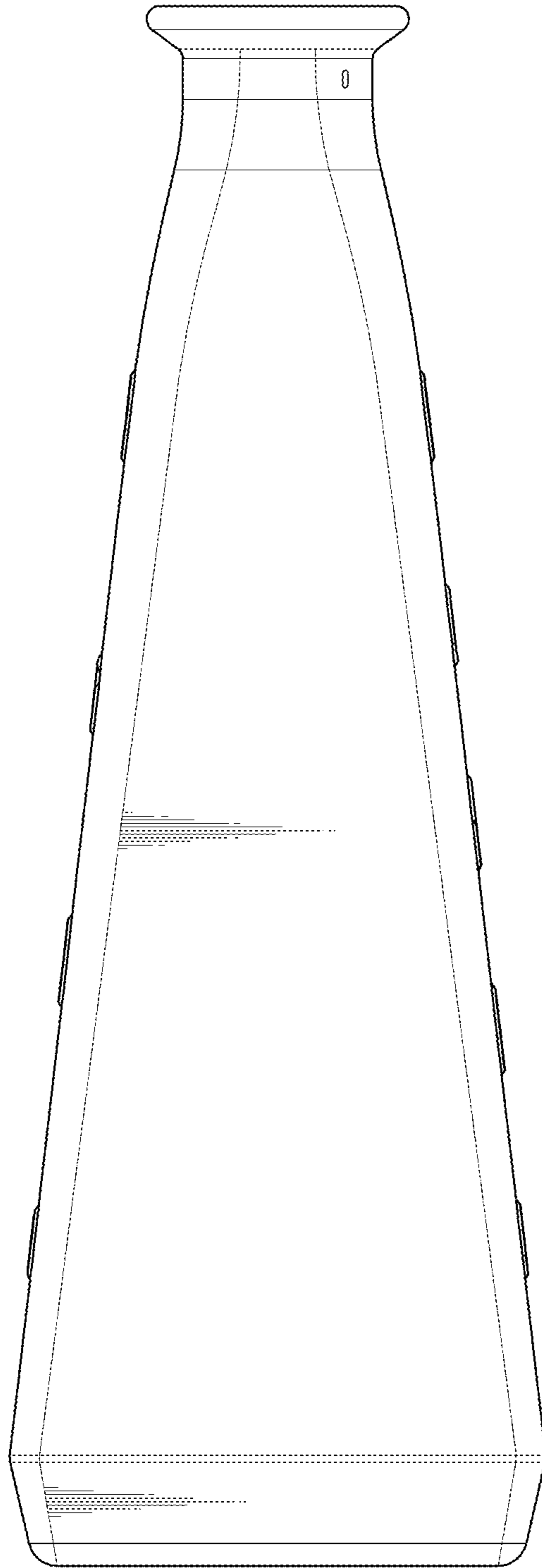

FIG. 4

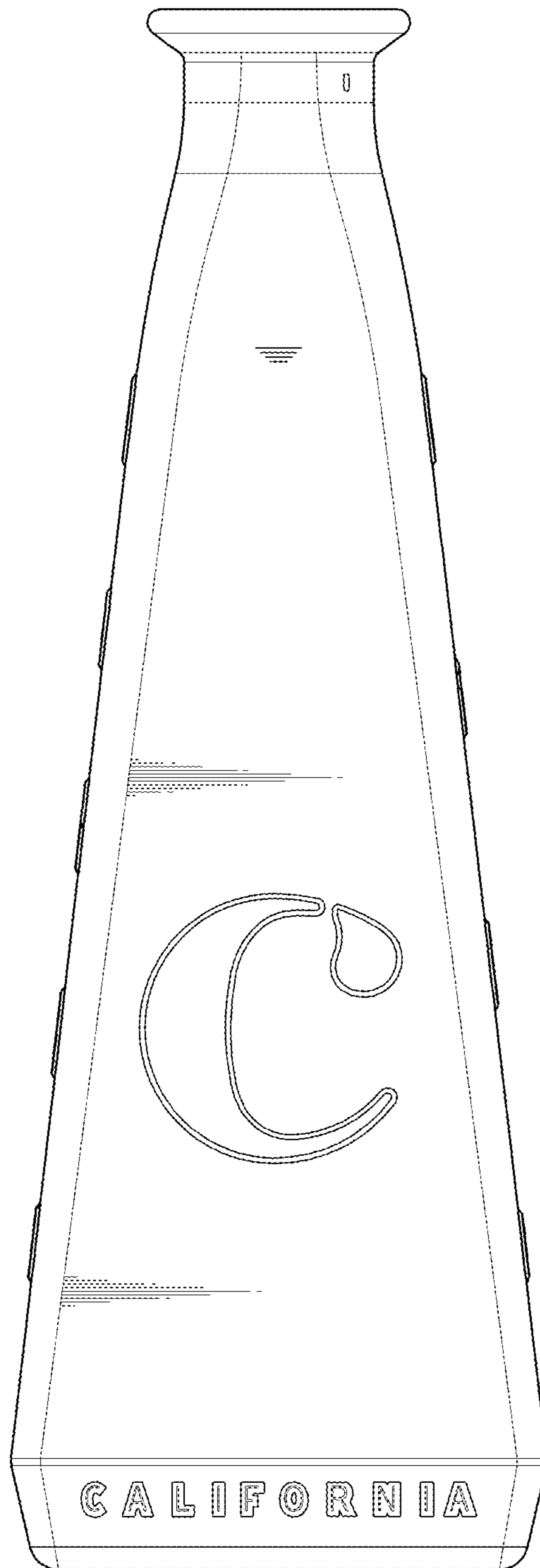

FIG. 5

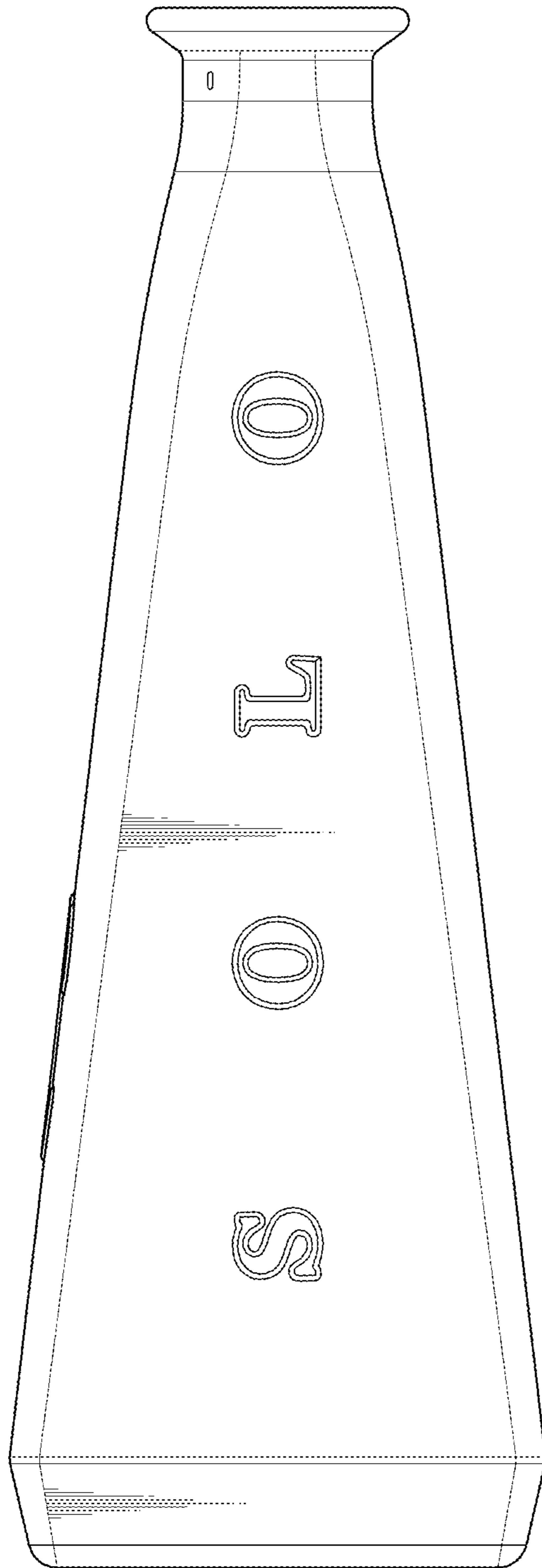

FIG. 6

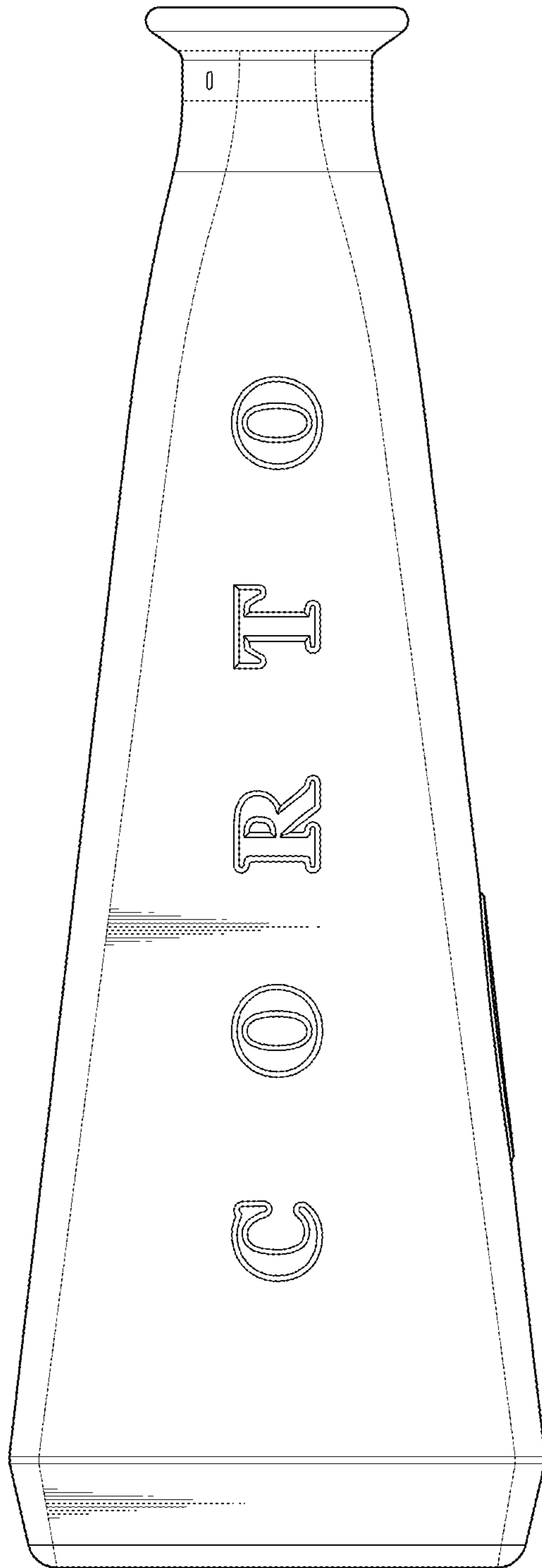

FIG. 7

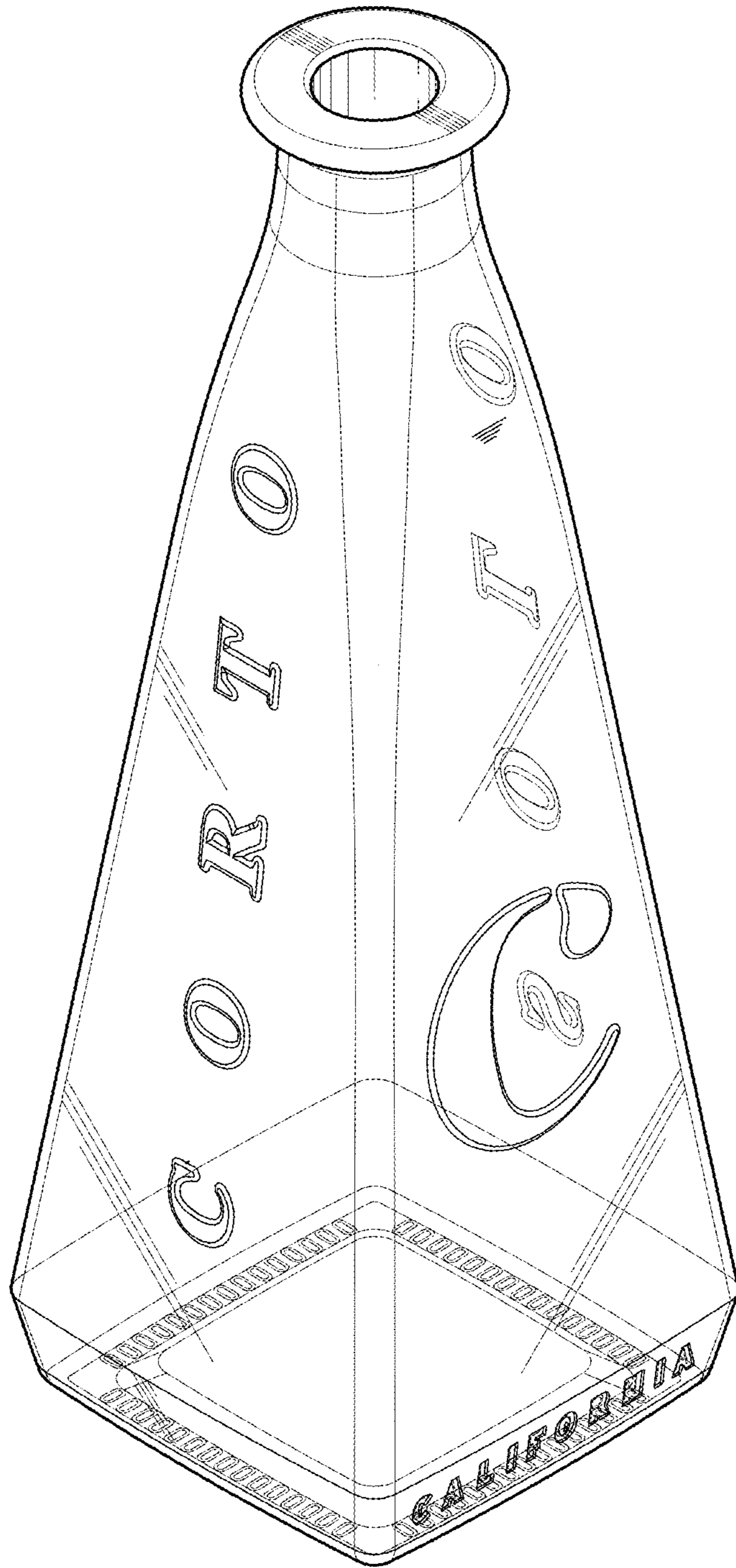

FIG. 8

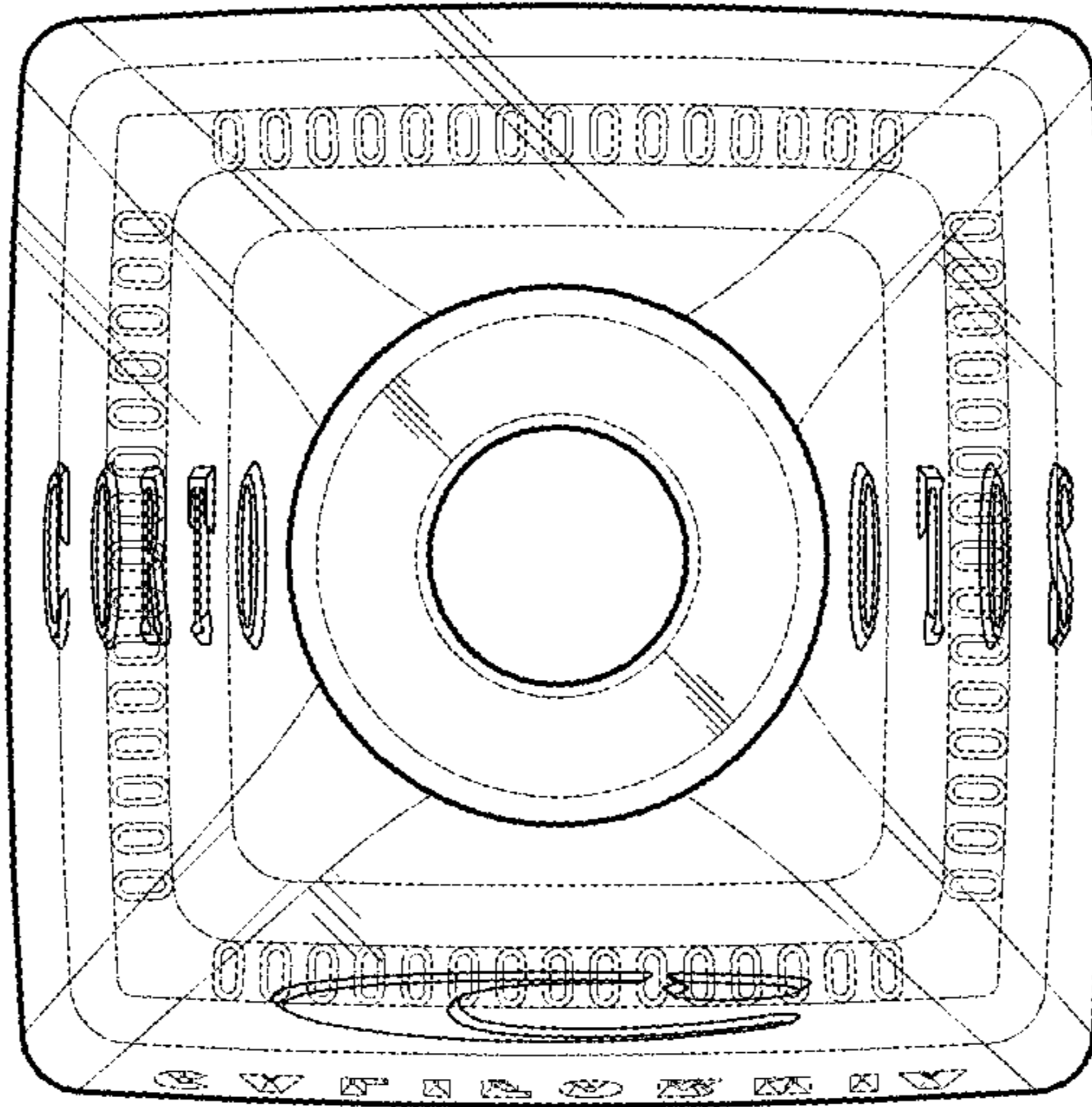

FIG. 9

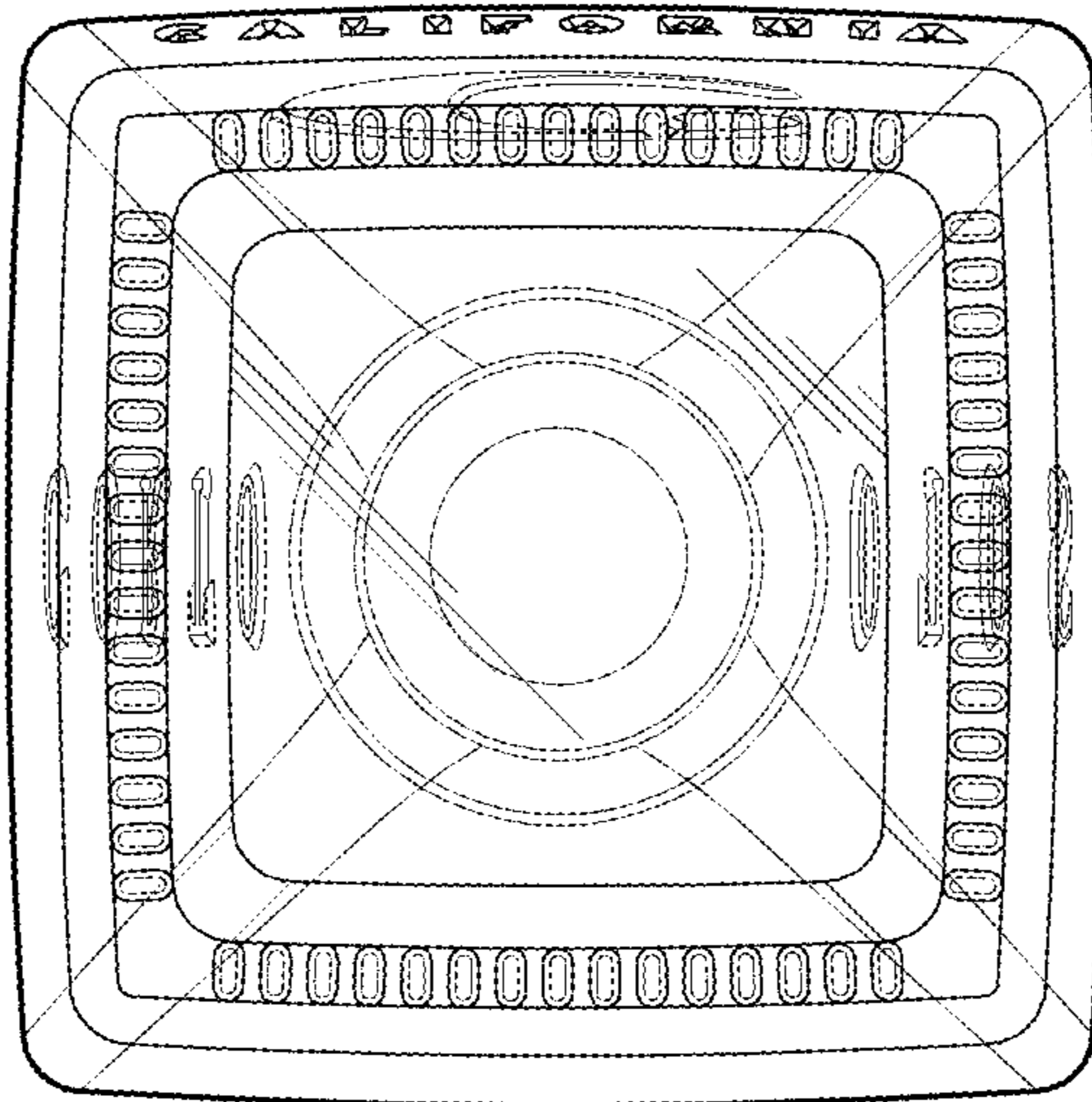

FIG. 10

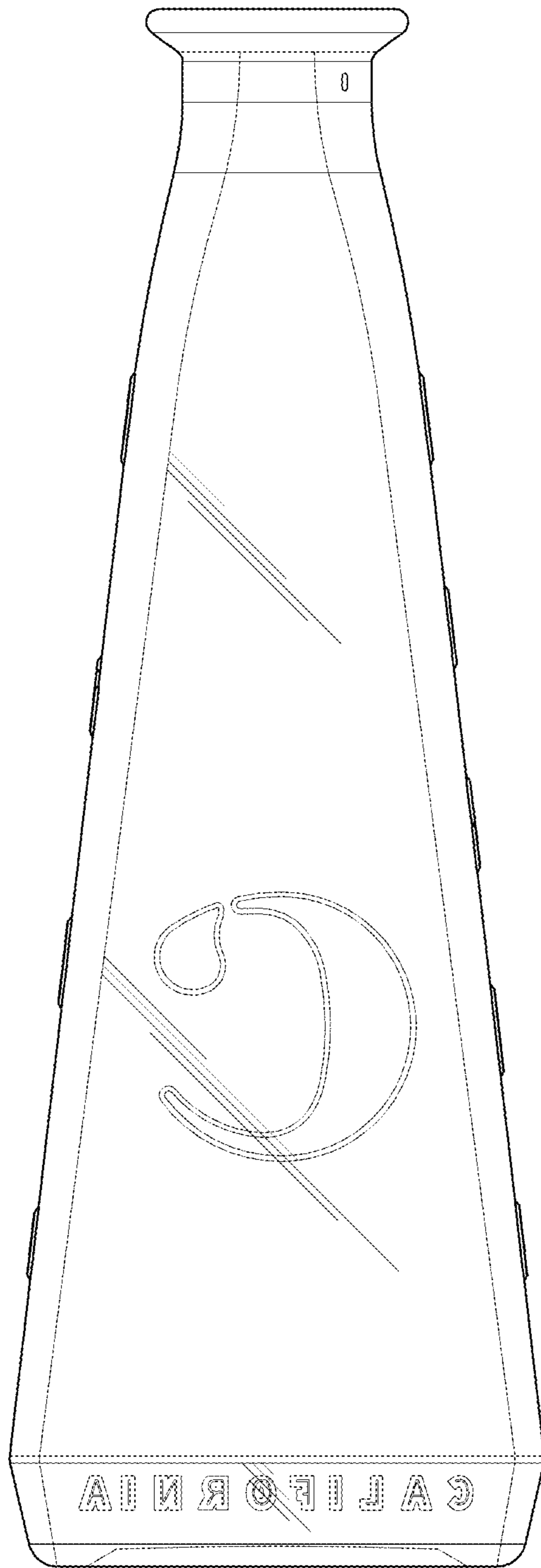

FIG. 11

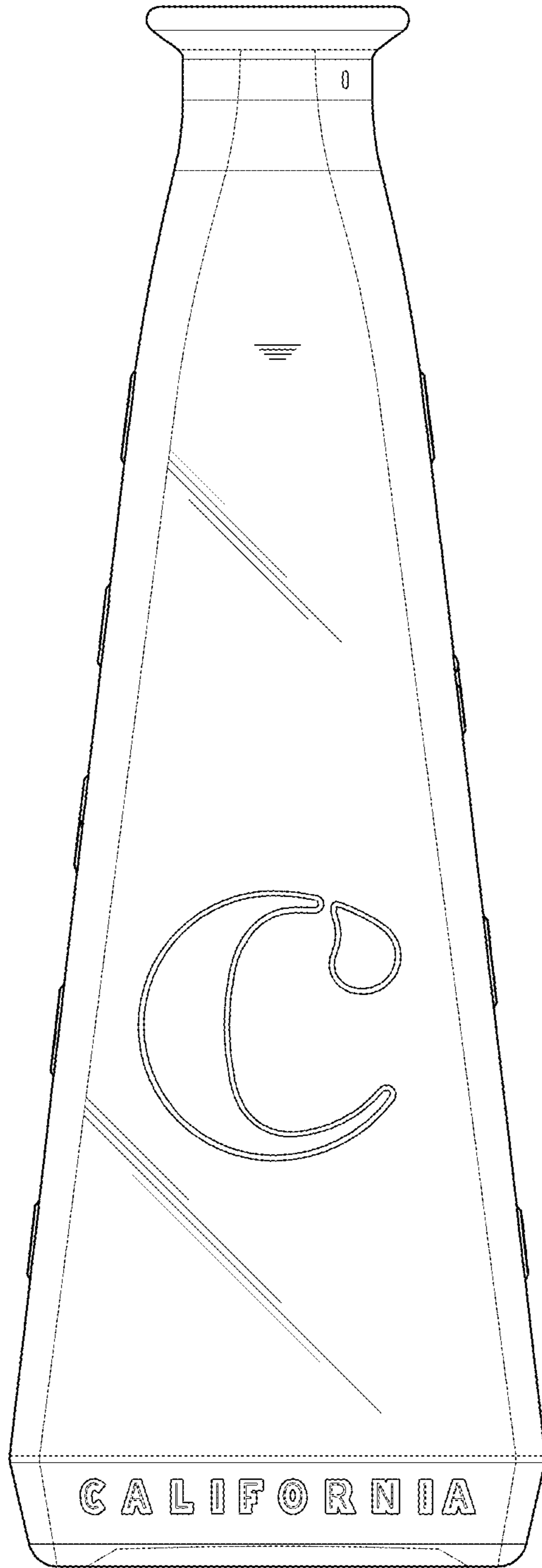

FIG. 12

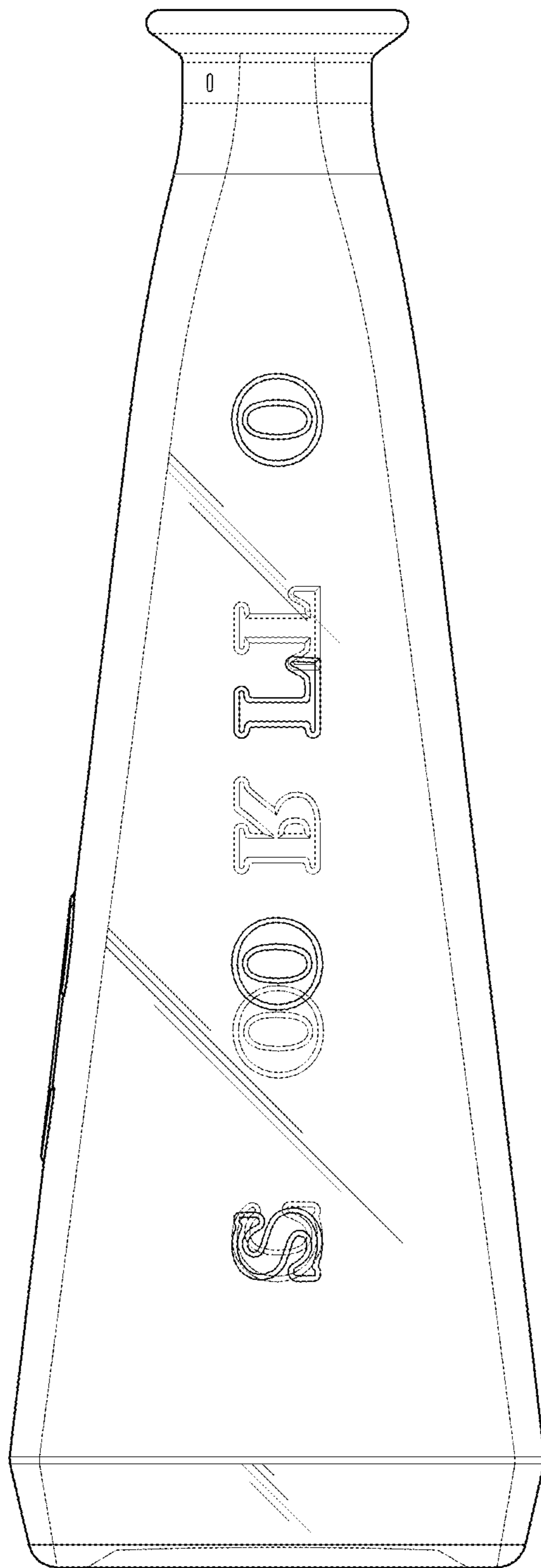

FIG. 13

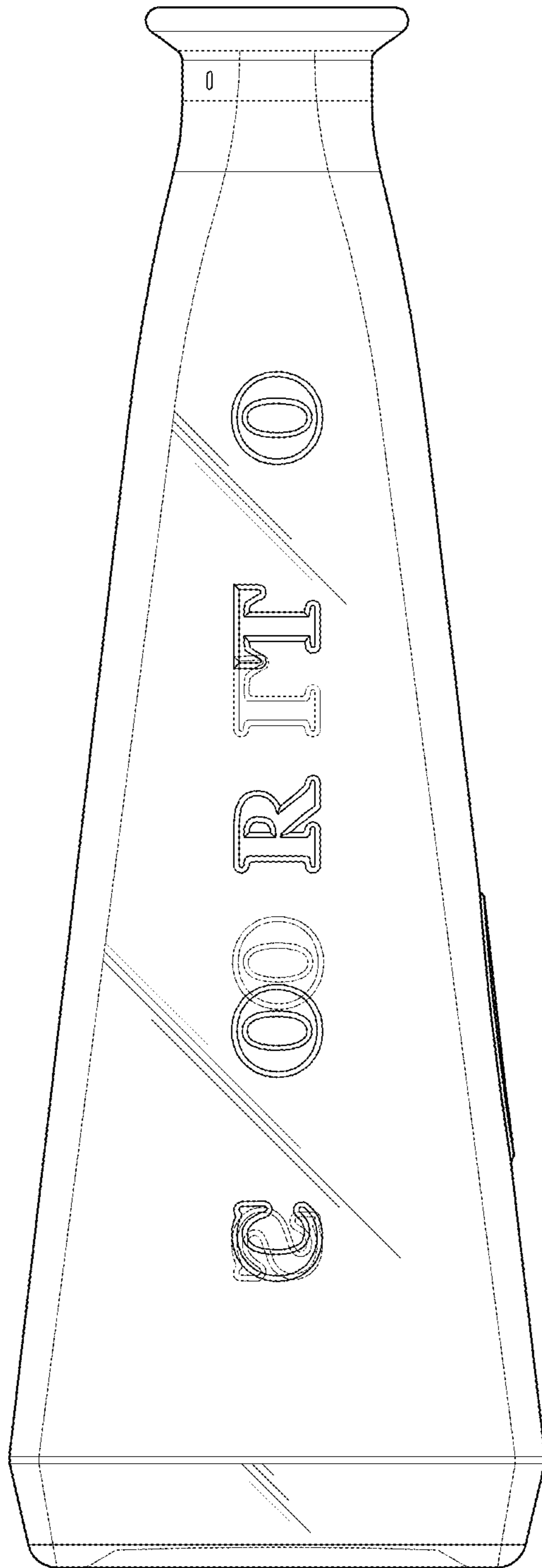

FIG. 14