



US00D949684S

(12) **United States Design Patent**
Helm et al.

(10) **Patent No.:** **US D949,684 S**

(45) **Date of Patent:** **** Apr. 26, 2022**

(54) **TAMPER-EVIDENT HINGE FOR A FOOD CONTAINER**

(71) Applicant: **Genpak, LLC**, Charlotte, NC (US)

(72) Inventors: **Neil Helm**, Charlotte, NC (US); **Brian S. Allers**, Fort Mill, SC (US)

(73) Assignee: **GENPAK, LLC**, Charlotte, NC (US)

(**) Term: **15 Years**

(21) Appl. No.: **29/770,292**

(22) Filed: **Feb. 10, 2021**

Related U.S. Application Data

(63) Continuation of application No. 29/676,605, filed on Jan. 11, 2019, now abandoned.

(51) **LOC (13) Cl.** **09-03**

(52) **U.S. Cl.**
USPC **D9/425**

(58) **Field of Classification Search**
USPC D7/400, 601, 608; D9/416, 417, 420, D9/425-429, 430, 432, 761
CPC . B65D 1/26; B65D 1/40; B65D 5/243; B65D 81/3453; B65D 2581/34; B65D 2581/3404; B65D 2581/3456
See application file for complete search history.

(56) **References Cited**

U.S. PATENT DOCUMENTS

D463,282 S *	9/2002	Mitchell	D9/500
7,568,589 B2	8/2009	Vovan		
D599,204 S *	9/2009	Georgiadis	D9/435
7,631,776 B2	12/2009	Vovan et al.		
D628,470 S	12/2010	Golota et al.		
D693,672 S	11/2013	Bontrager et al.		
8,925,755 B2	1/2015	Lesquir et al.		
9,365,331 B2	6/2016	Gingras et al.		

D920,100 S *	5/2021	Murphy	D9/434
2008/0006632 A1 *	1/2008	Vovan	B65D 43/0235 220/266
2008/0116163 A1 *	5/2008	Sawyer	B65D 50/046 215/225
2008/0149639 A1 *	6/2008	Luburic	B65D 21/0233 220/276
2008/0190803 A1 *	8/2008	Blumenschein	...	B65D 43/0254 206/509

(Continued)

Primary Examiner — Janice Patyk

(74) *Attorney, Agent, or Firm* — Laurence & Phillips IP Law

(57) **CLAIM**

The ornamental design for a tamper-evident hinge for a food container, as shown and described.

DESCRIPTION

FIG. 1 is a first perspective view of a tamper-evident hinge for a food container showing our new design.

FIG. 2 is a top plan view thereof.

FIG. 3 is a bottom plan view thereof.

FIG. 4 is a front view thereof.

FIG. 5 is a left side view thereof.

FIG. 6 is a right side view thereof.

FIG. 7 is a rear view thereof; and,

FIG. 8 is a second perspective view thereof, shown in environmental use, in reduced scale.

The evenly-spaced broken lines in the figures illustrate the portions of the tamper-evident hinge for a food container that form no part of the claimed design.

The broken line showing of container in FIG. 8 is for the purpose of illustrating environmental subject matter that forms no part of the claimed design.

The long segmented broken lines on the top and bottom surfaces of FIGS. 1-3 and 8 are included to show a claimed tear line on the article.

1 Claim, 5 Drawing Sheets

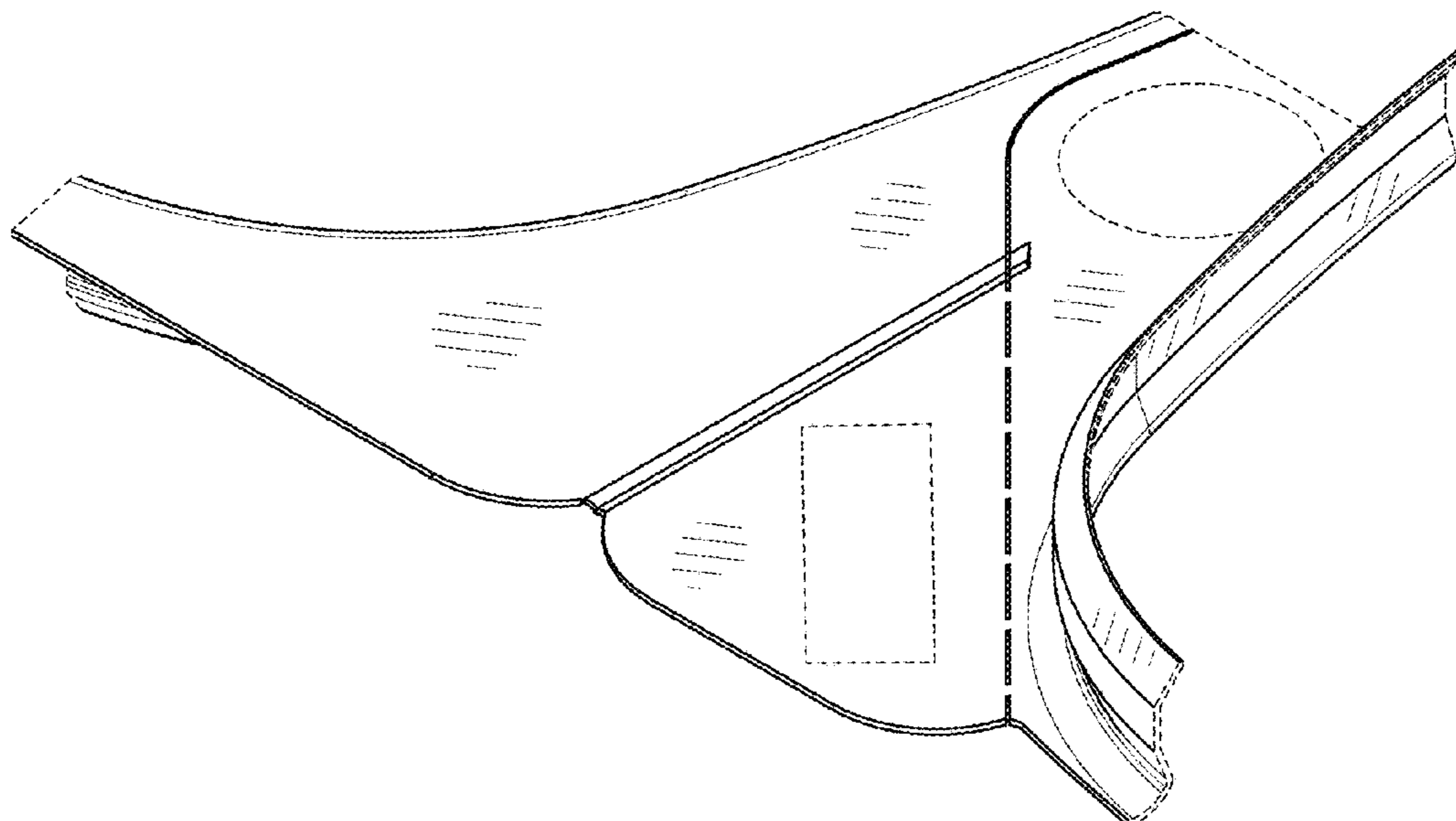

(56)

References Cited

U.S. PATENT DOCUMENTS

2009/0014456 A1* 1/2009 Woinarski B65D 43/0208
220/790
2013/0020325 A1 1/2013 Stone et al.
2015/0298853 A1 10/2015 Chen
2015/0367987 A1 12/2015 Clark et al.

* cited by examiner

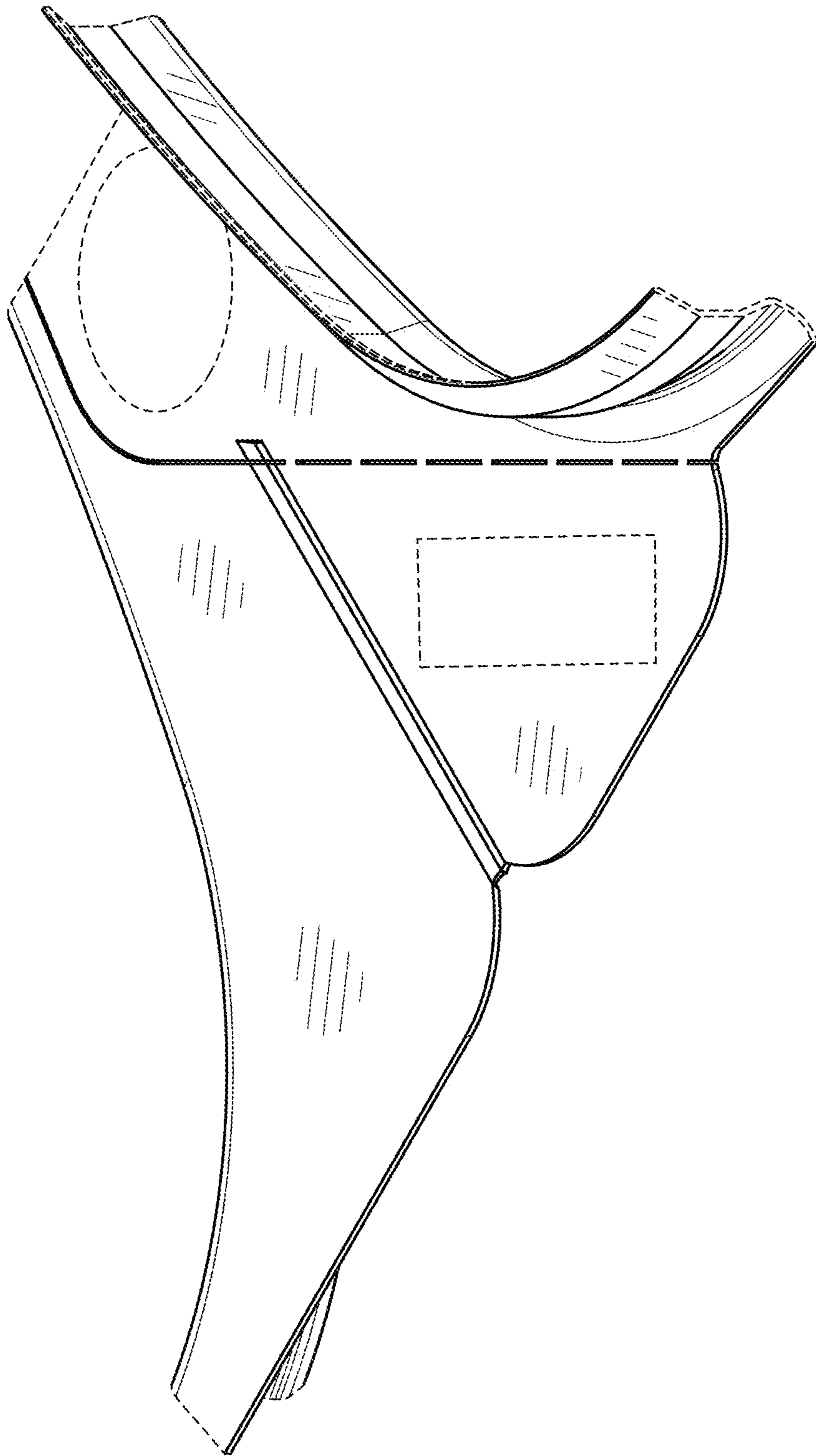

FIG. 1

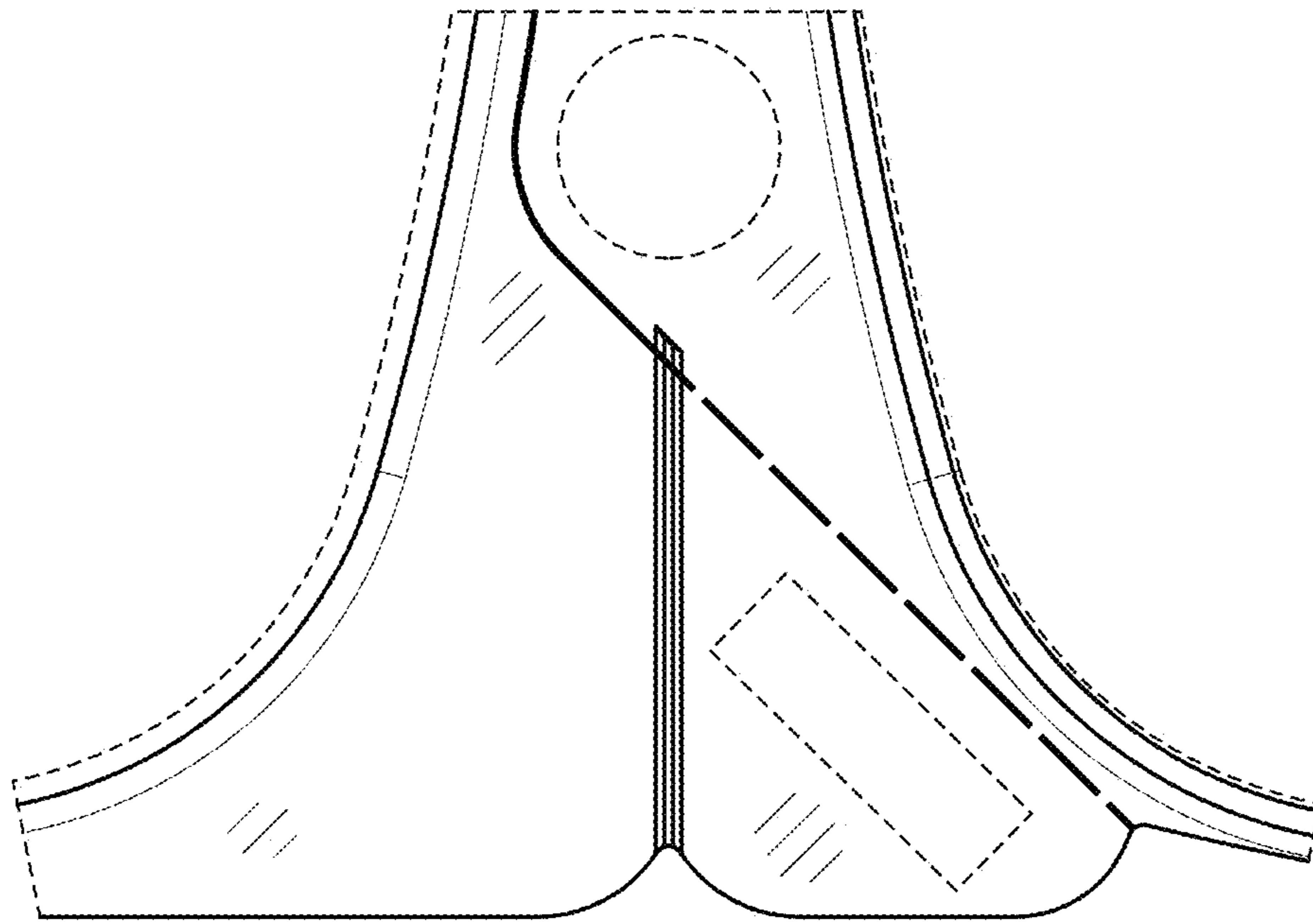

FIG. 2

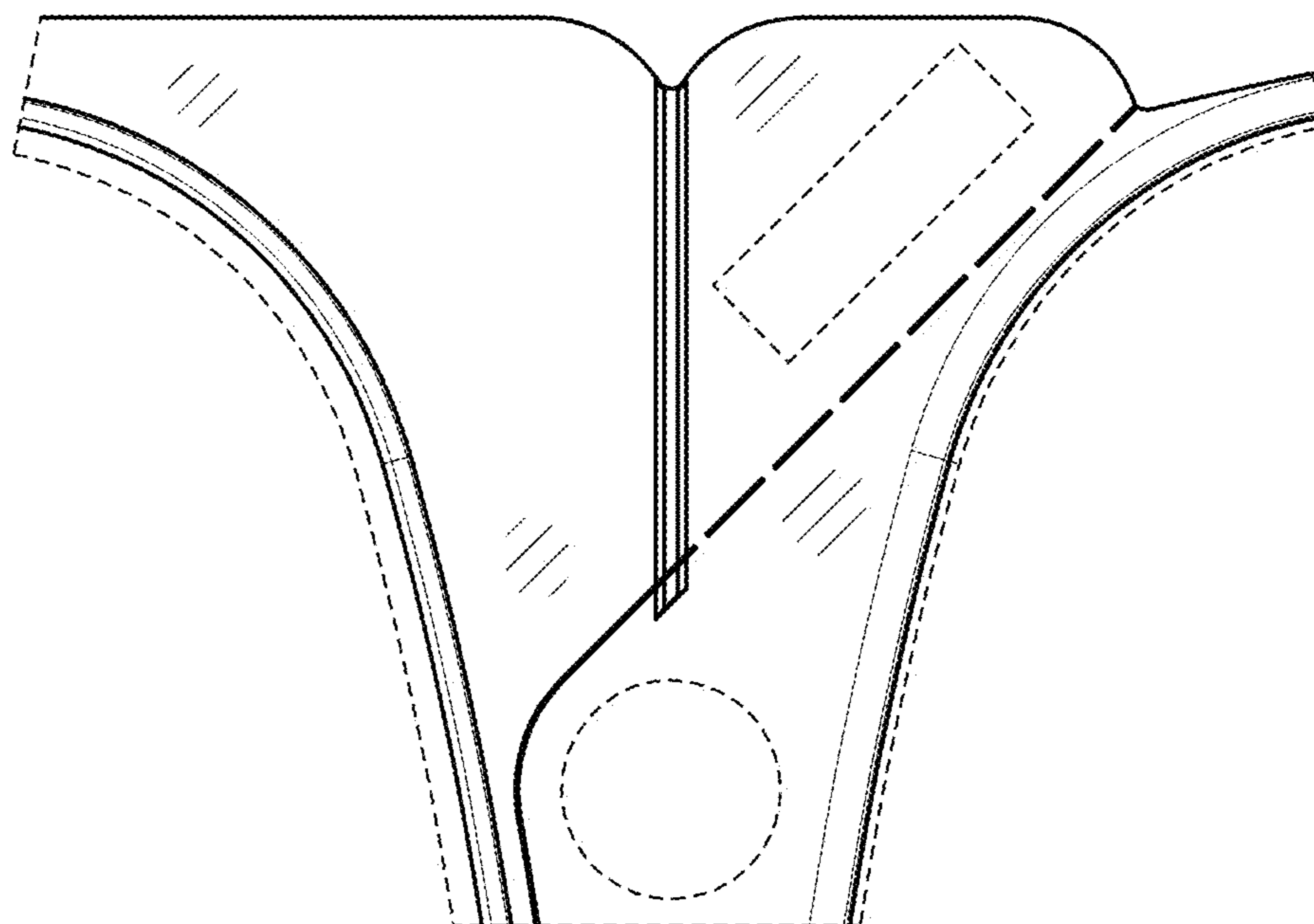

FIG. 3

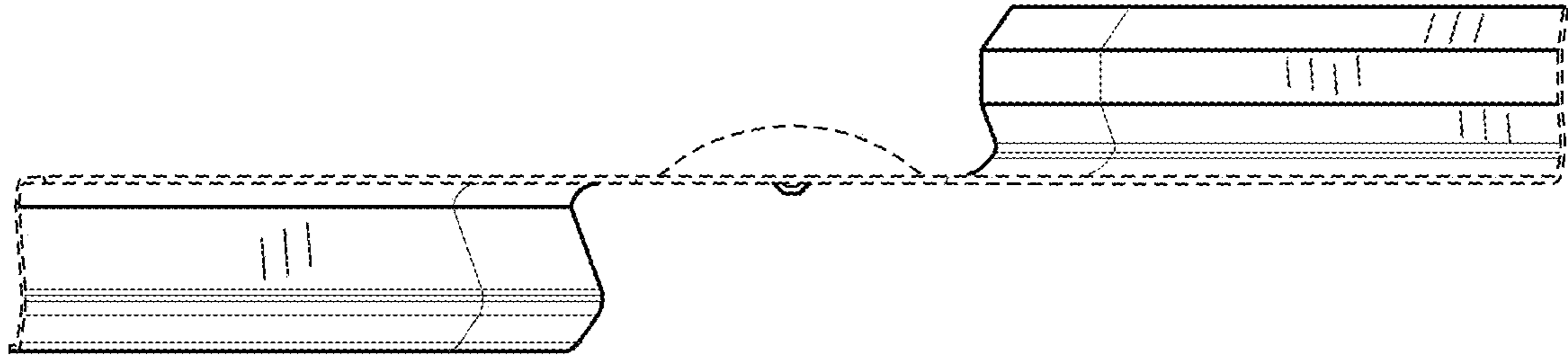

FIG. 4

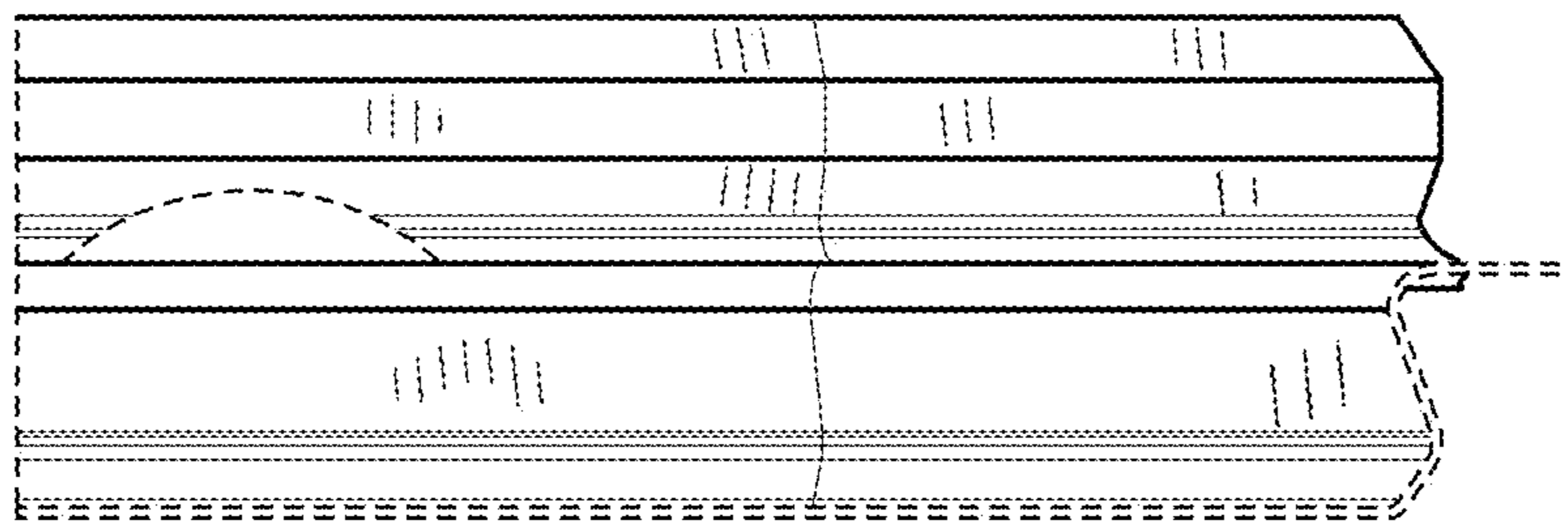

FIG. 5

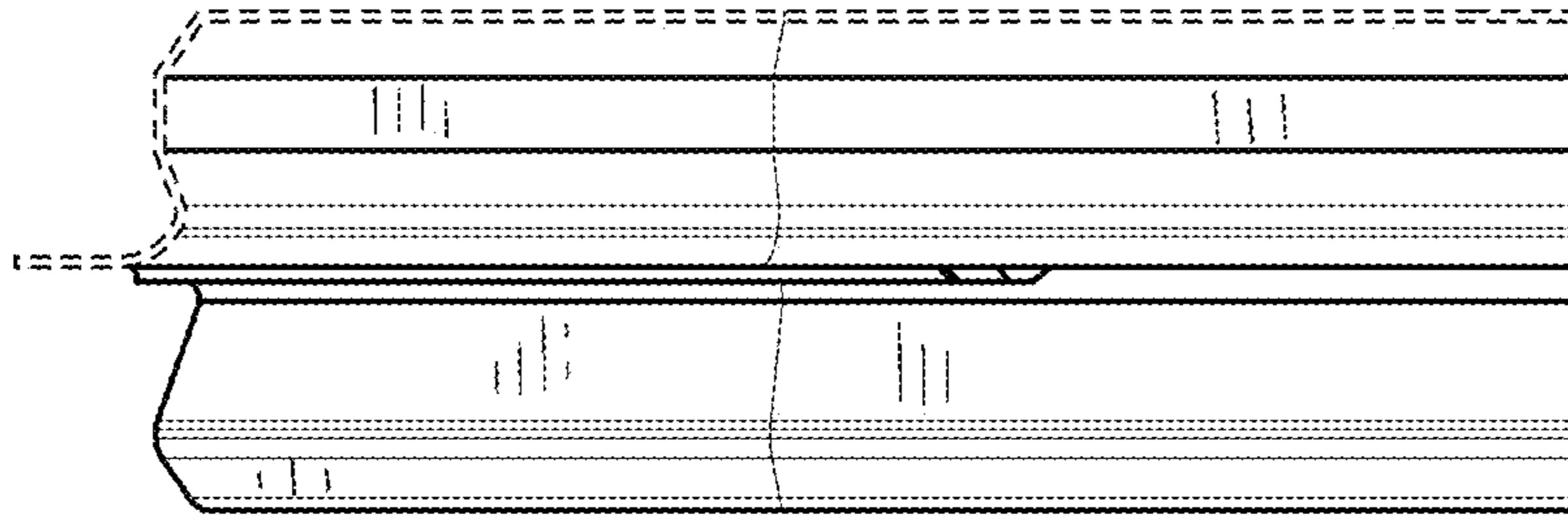

FIG. 6

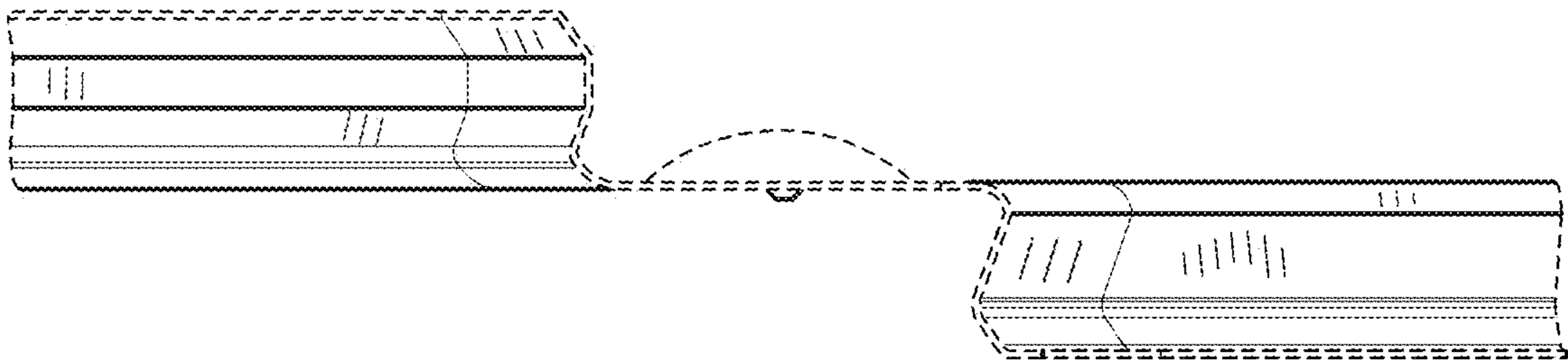

FIG. 7

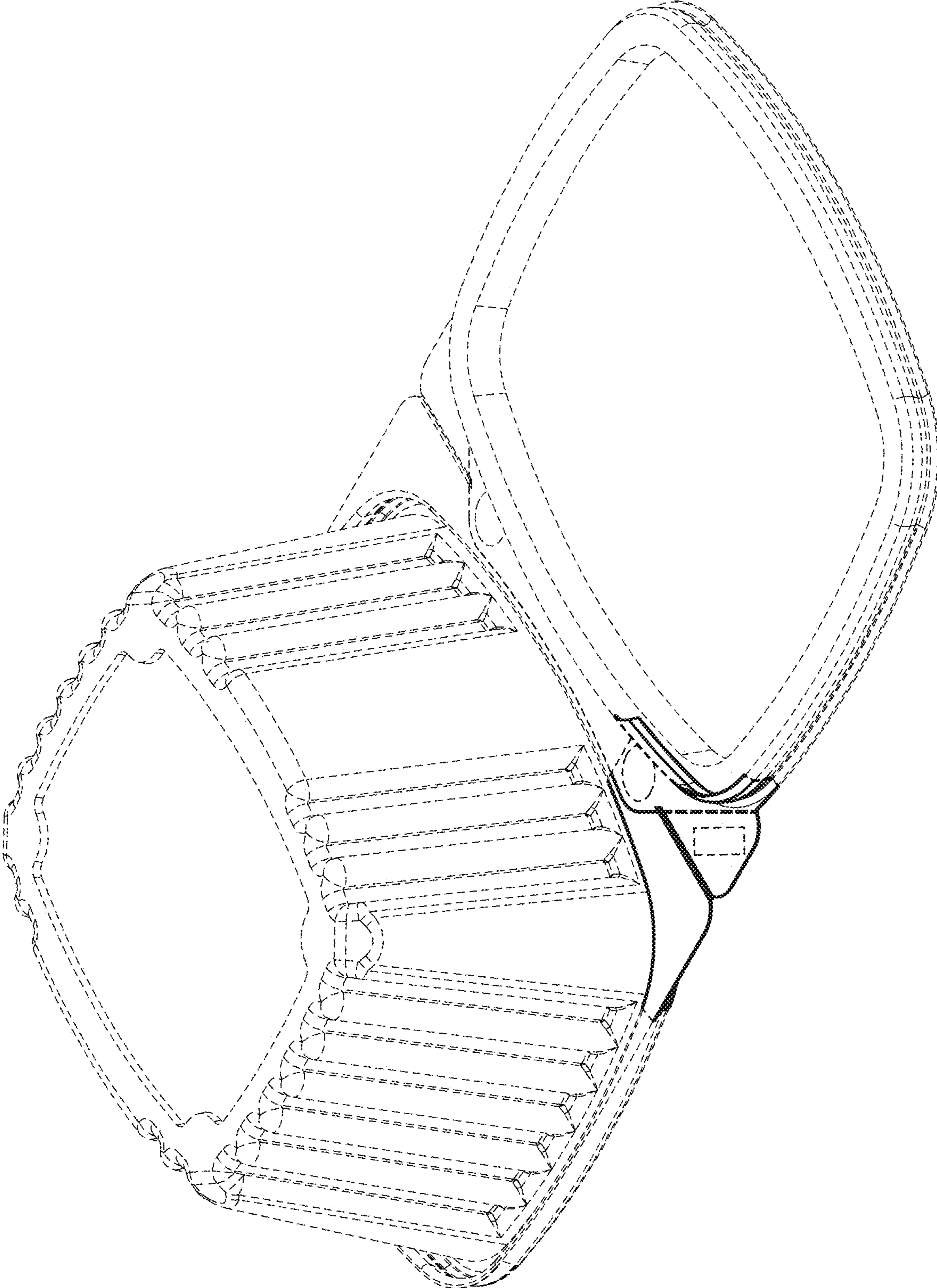

FIG. 8