



US00D949674S

(12) **United States Design Patent** (10) **Patent No.:** **US D949,674 S**
He et al. (45) **Date of Patent:** **** Apr. 26, 2022**

(54) **TOGGLE**

F16B 37/14; F16B 37/145; F16B 13/08;
F16B 13/04; F16B 13/0808

(71) Applicants: **Zhifeng He**, Tianjin (CN); **Zhiqiang He**, Tianjin (CN)

See application file for complete search history.

(72) Inventors: **Zhifeng He**, Tianjin (CN); **Zhiqiang He**, Tianjin (CN)

(56) **References Cited**

(**) Term: **15 Years**

U.S. PATENT DOCUMENTS

(21) Appl. No.: **29/741,774**

2,998,743 A * 9/1961 Apfelzweig F16B 13/0808
411/342
4,043,245 A * 8/1977 Kaplan F16B 37/04
411/346
4,075,924 A * 2/1978 McSherry F16B 13/0808
411/112

(22) Filed: **Jul. 15, 2020**

(Continued)

(30) **Foreign Application Priority Data**

FOREIGN PATENT DOCUMENTS

Jun. 10, 2020 (CN) 202030292756.4

CA 2362168 A1 * 8/2000 F16B 13/0808
CA 2502044 A1 * 9/2006 F16B 13/003

(51) **LOC (13) Cl.** **08-08**

(Continued)

(52) **U.S. Cl.**

Primary Examiner — Sheryl Lane

USPC **D8/385**

Assistant Examiner — Ieisha N Price

(58) **Field of Classification Search**

(74) *Attorney, Agent, or Firm* — Westbridge IP LLC

USPC D8/1, 2, 349, 382, 384, 385, 388, 392,
D8/393, 387, 391

(57) **CLAIM**

CPC F16B 23/0007; F16B 23/0015; F16B
23/0023; F16B 23/003; F16B 23/0038;
F16B 23/0046; F16B 23/0053; F16B
23/0061; F16B 23/0069; F16B 23/0076;
F16B 23/0084; F16B 23/0092; F16B
25/0036; F16B 25/0042; F16B 25/0047;
F16B 25/0052; F16B 25/0057; F16B
25/0063; F16B 25/0068; F16B 25/0073;
F16B 25/0078; F16B 25/0084; F16B
33/02; F16B 2033/025; F16B 2033/04;
F16B 33/06; F16B 35/04; F16B 35/041;
F16B 35/042; F16B 35/044; F16B
35/045; F16B 35/047; F16B 35/048;
F16B 35/06; F16B 35/065; F16B 37/047;

The ornamental design for the toggle, as shown and described.

DESCRIPTION

FIG. 1 is a perspective view of the toggle showing our new design;
FIG. 2 is a front view thereof;
FIG. 3 is a rear view thereof;
FIG. 4 is a left view thereof;
FIG. 5 is a right view thereof;
FIG. 6 is a top view thereof;
FIG. 7 is a bottom view thereof; and,
FIG. 8 is another perspective view thereof, showing other status of the toggle in which the cap portion pivots and the block penetrated through by the main stem portion moves upwards along the main stem.

(Continued)

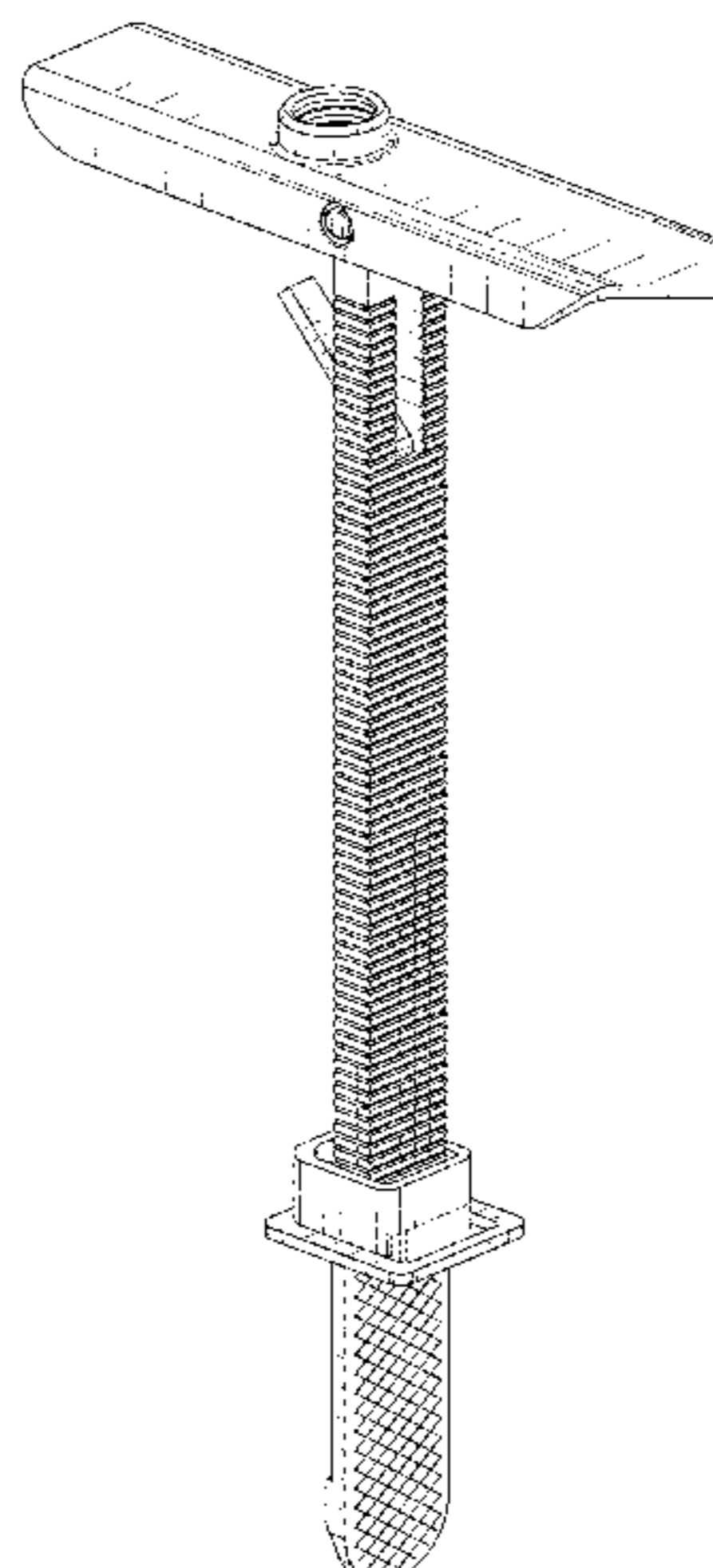

The broken lines are shown for the purpose of illustrating portions of the toggle and form no part of the claimed design.

1 Claim, 6 Drawing Sheets

(56) **References Cited**

U.S. PATENT DOCUMENTS

4,294,156 A * 10/1981 McSherry F16B 37/04
411/345
D330,324 S * 10/1992 Solbeck D25/68
D421,896 S * 3/2000 Hamernik D8/382
D481,001 S * 10/2003 Gaudron D12/215
D651,890 S * 1/2012 Gaudron D8/385
D829,085 S * 9/2018 Daly D8/382
D871,900 S * 1/2020 McDuff D8/385
2004/0170486 A1 * 9/2004 DeMeo F16B 13/0808
411/340
2011/0268528 A1 * 11/2011 Gaudron F16B 13/0808
411/44
2012/0328392 A1 * 12/2012 Difante F16B 13/0808
411/342
2019/0107136 A1 * 4/2019 Daly F16B 13/0808
2019/0331147 A1 * 10/2019 McDuff F16B 13/002

FOREIGN PATENT DOCUMENTS

DE 102014015678 A1 * 4/2016 F16B 13/0808
DE 102014015679 A1 * 4/2016 F16B 13/0808
DE 102015113332 A1 * 4/2016 F16B 13/0808
DE 102015116422 A1 * 3/2017 F16B 13/0808

* cited by examiner

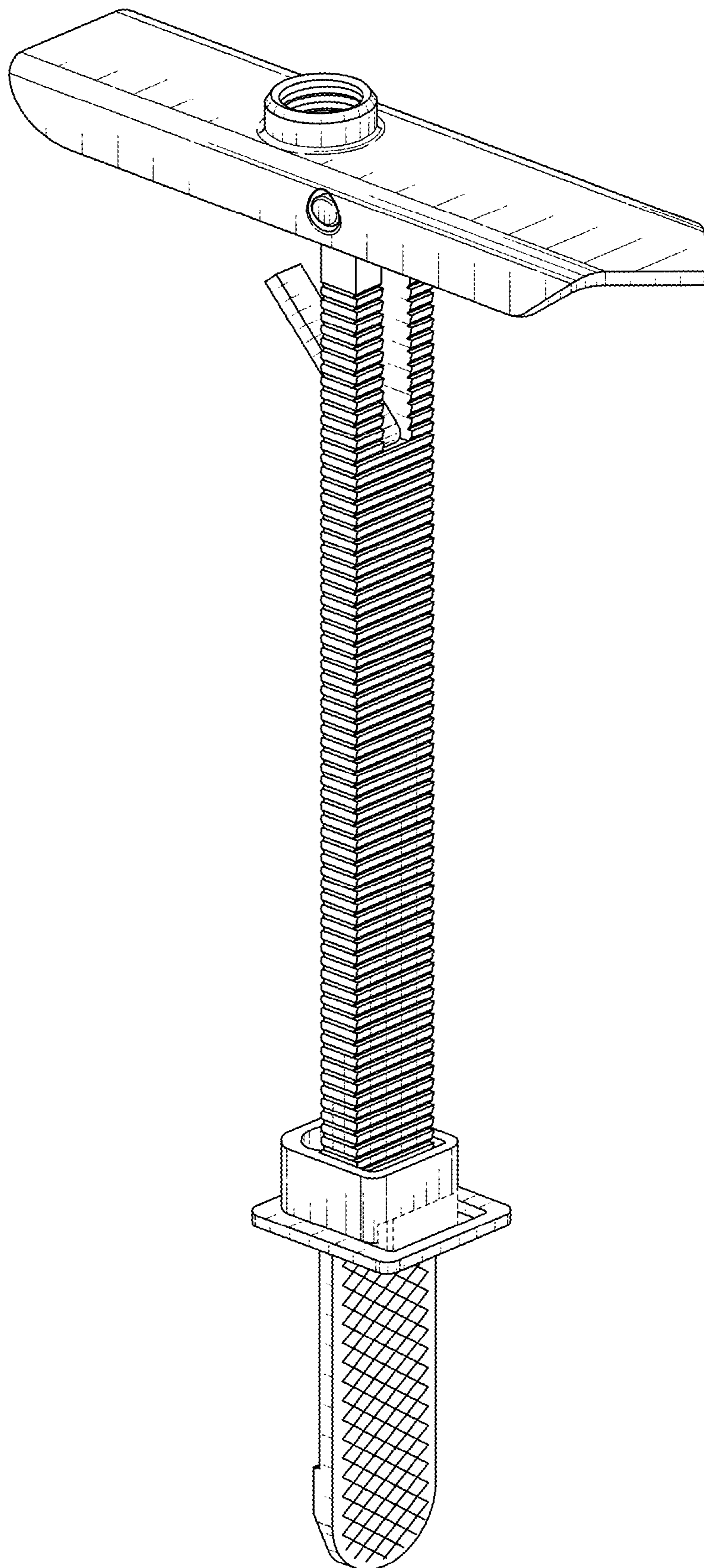

FIG. 1

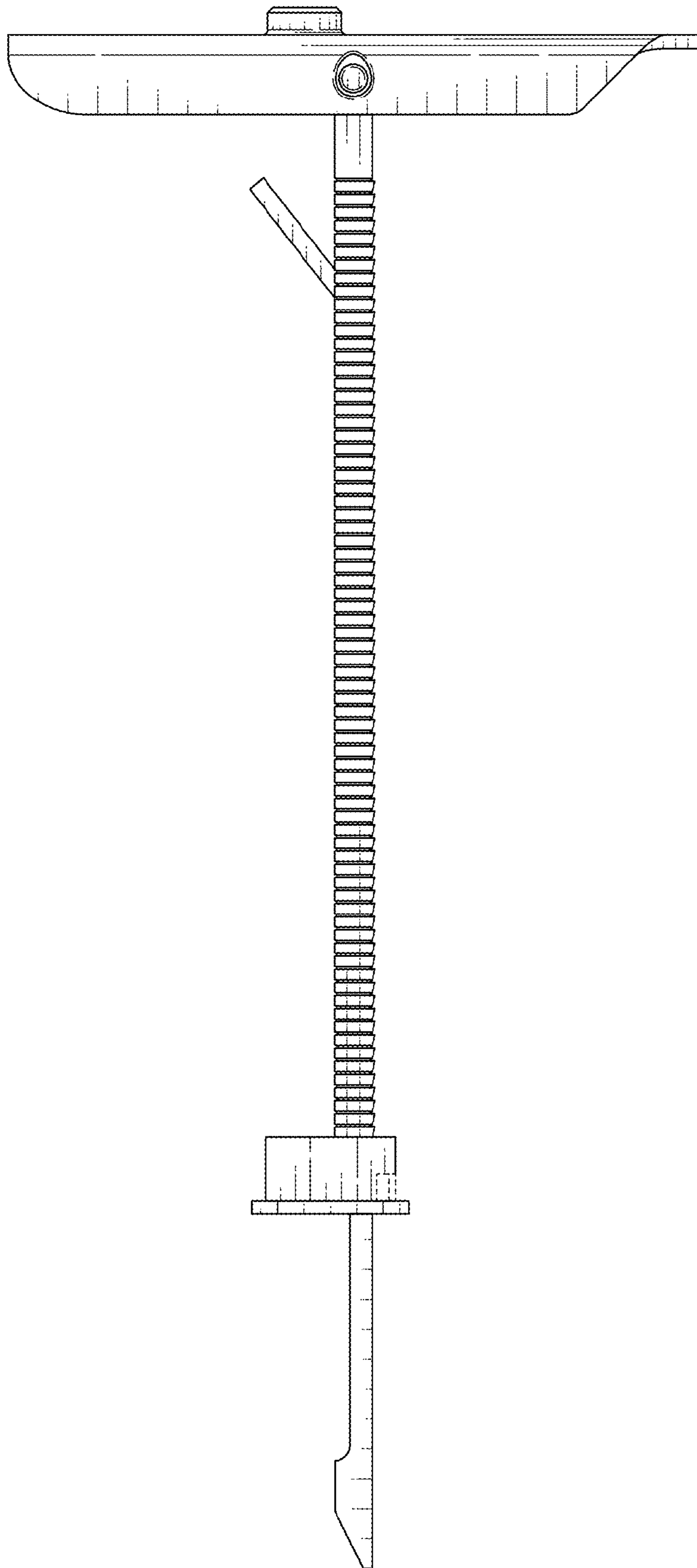

FIG. 2

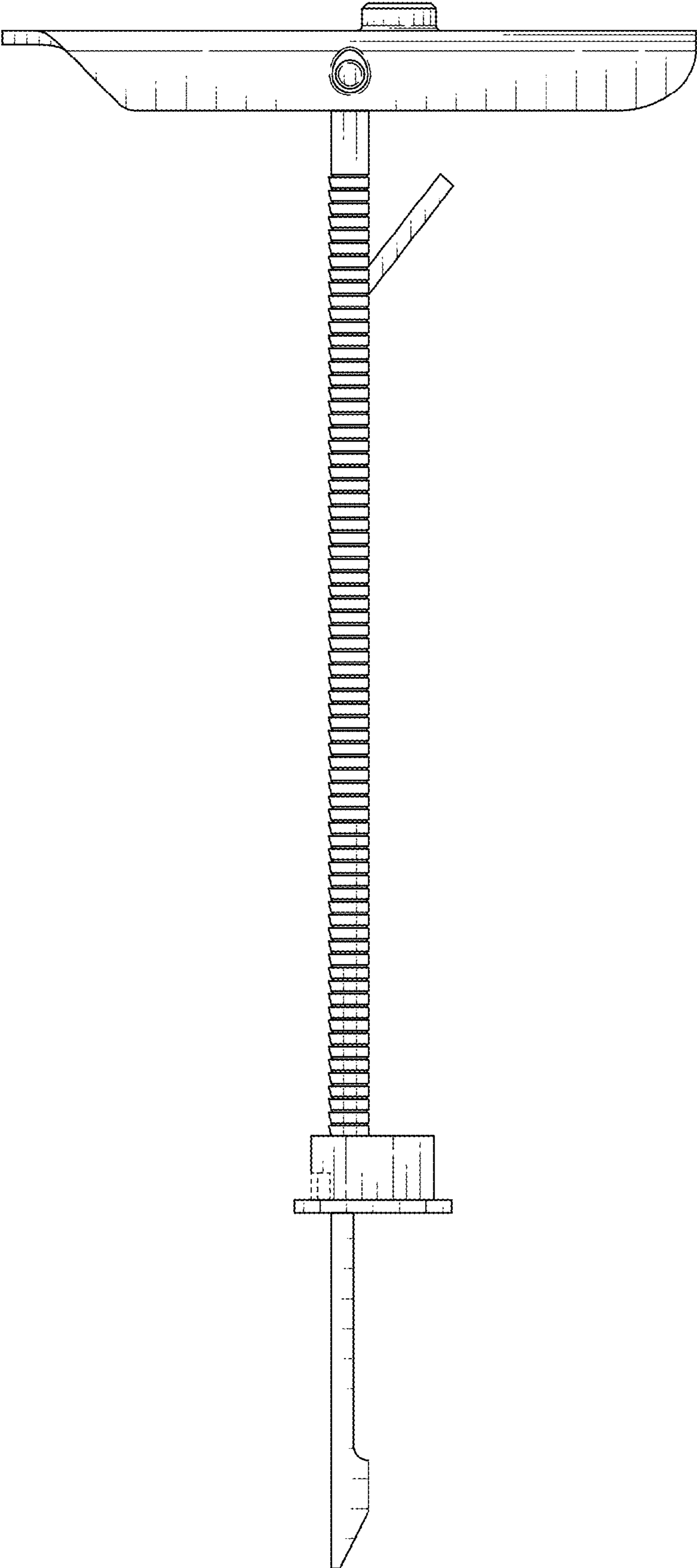

FIG. 3

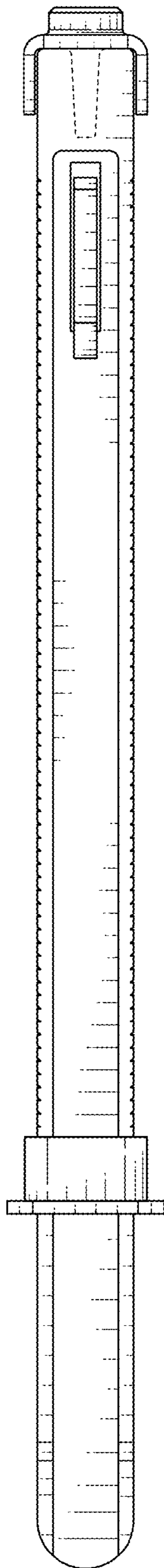

FIG. 4

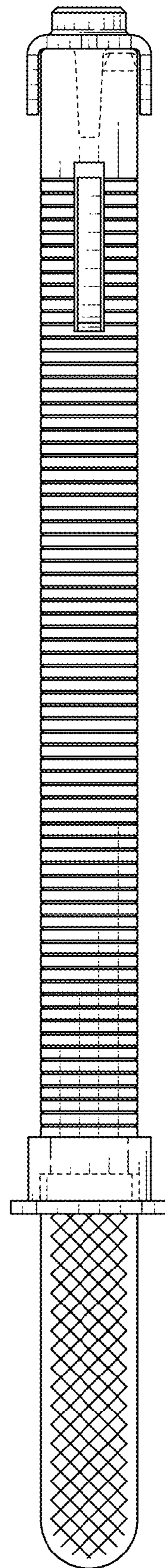

FIG. 5

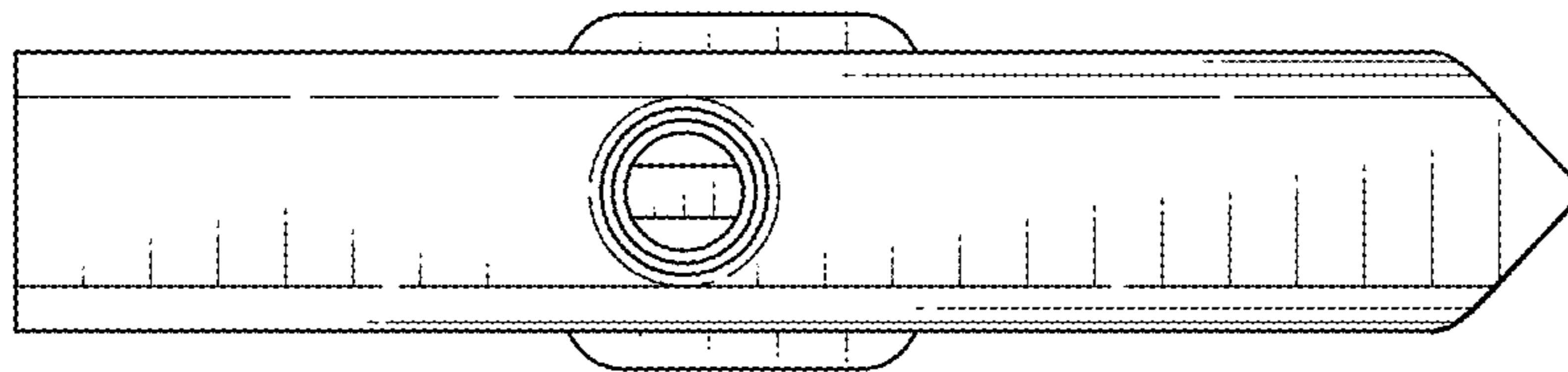

FIG. 6

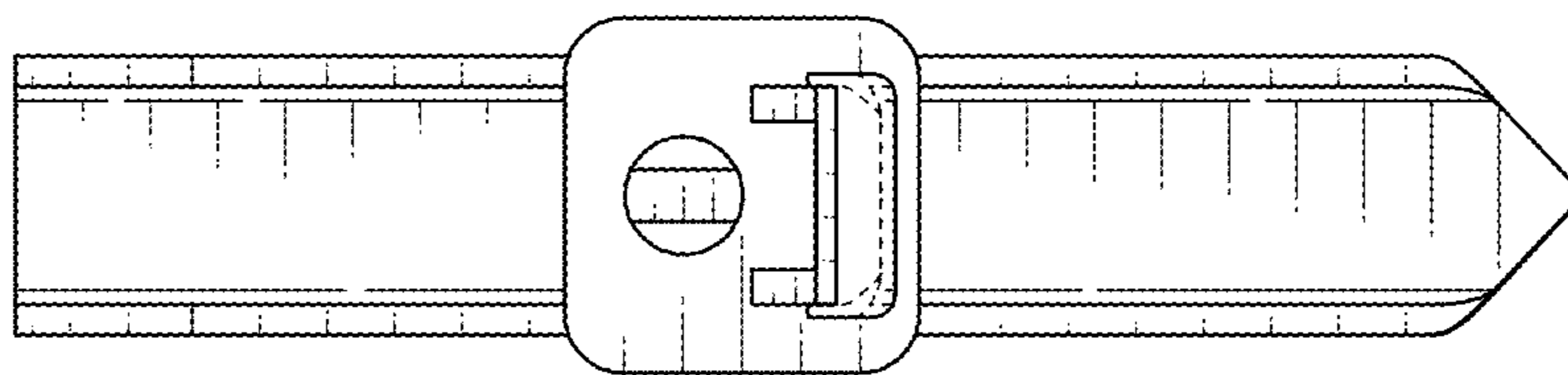

FIG. 7

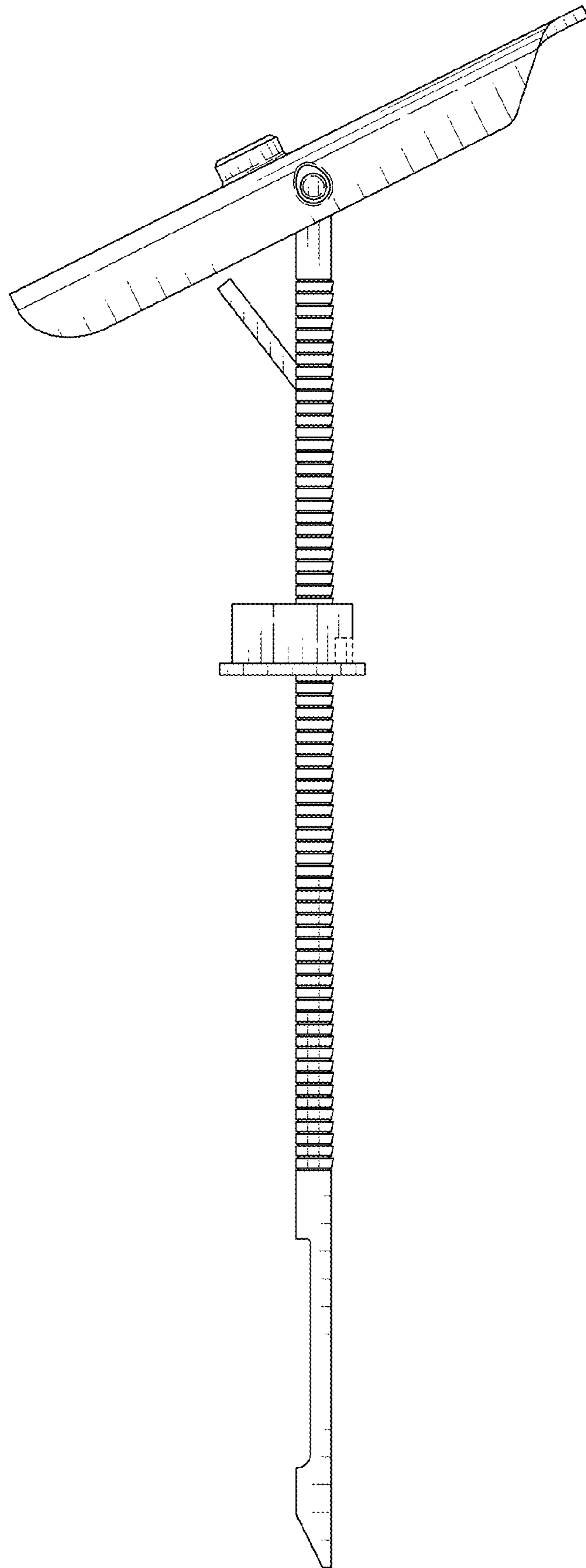

FIG. 8