



US00D949633S

(12) **United States Design Patent** (10) **Patent No.:** **US D949,633 S**
Wahl et al. (45) **Date of Patent:** **** Apr. 26, 2022**

(54) **BEVERAGE CONTAINER**

- (71) Applicant: **Pacific Market International, LLC**,
Seattle, WA (US)
- (72) Inventors: **Andrew C. F. Wahl**, Seattle, WA (US);
Matthew Kenneth Dolph, Seattle, WA
(US)
- (73) Assignee: **Pacific Market International, LLC**,
Seattle, WA (US)
- (**) Term: **15 Years**
- (21) Appl. No.: **29/726,746**
- (22) Filed: **Mar. 5, 2020**

Related U.S. Application Data

- (63) Continuation of application No. 29/720,574, filed on
Jan. 14, 2020.
- (51) **LOC (13) Cl.** **07-01**
- (52) **U.S. Cl.**
USPC **D7/608**
- (58) **Field of Classification Search**
USPC D7/605–608, 509–511, 619.1–625, 629,
D7/630; D9/500, 502–505, 516, 549,
D9/557, 558
CPC B65D 81/3837; B65D 81/3839; B65D
81/3841; B65D 81/3844; B65D 81/3846;
B65D 81/3869; B65D 81/3881; B65D
81/3876; B65D 81/3865; B65D 81/38;
B65D 23/104; B65D 1/00; B65D 1/02;
B65D 2501/00; B65D 2501/0009; A47J
41/0005; A47J 41/0083; A47J 41/02;
A47J 41/024; A47J 41/026; A47J 41/028;
A47J

(Continued)

(56) **References Cited**

U.S. PATENT DOCUMENTS

- D120,134 S 4/1940 Morrison
- 2,963,187 A * 12/1960 Bramming A47J 41/02
215/12.1
- D234,110 S 1/1975 Achenbach

(Continued)

OTHER PUBLICATIONS

Information Disclosure Statement Transmittal Letter filed herewith,
dated Jul. 6, 2020, 2 pages.
(Continued)

Primary Examiner — Terry A Wallace
(74) *Attorney, Agent, or Firm* — George C. Rondeau, Jr.;
Davis Wright Tremaine, LLP

(57) **CLAIM**

The ornamental design for a beverage container, as shown
and described.

DESCRIPTION

FIG. 1 is a top perspective view of a beverage container showing our new design.
FIG. 2 is a bottom perspective view thereof.
FIG. 3 is a left side view thereof.
FIG. 4 is a rear view thereof.
FIG. 5 is a right side view thereof.
FIG. 6 is a front view thereof.
FIG. 7 is a top plan view thereof.
FIG. 8 is a bottom plan view thereof.
FIG. 9 is a top perspective view of an alternate embodiment of FIG. 1.
FIG. 10 is a bottom perspective view of FIG. 9.
FIG. 11 is a left side view of FIG. 9.
FIG. 12 is a rear view of FIG. 9.
FIG. 13 is a right side view of FIG. 9.
FIG. 14 is a front view of FIG. 9.
FIG. 15 is a top plan view of FIG. 9; and,
FIG. 16 is a bottom plan view of FIG. 9.
The broken lines depict portions of the beverage container which form no part of the claimed design.

1 Claim, 14 Drawing Sheets

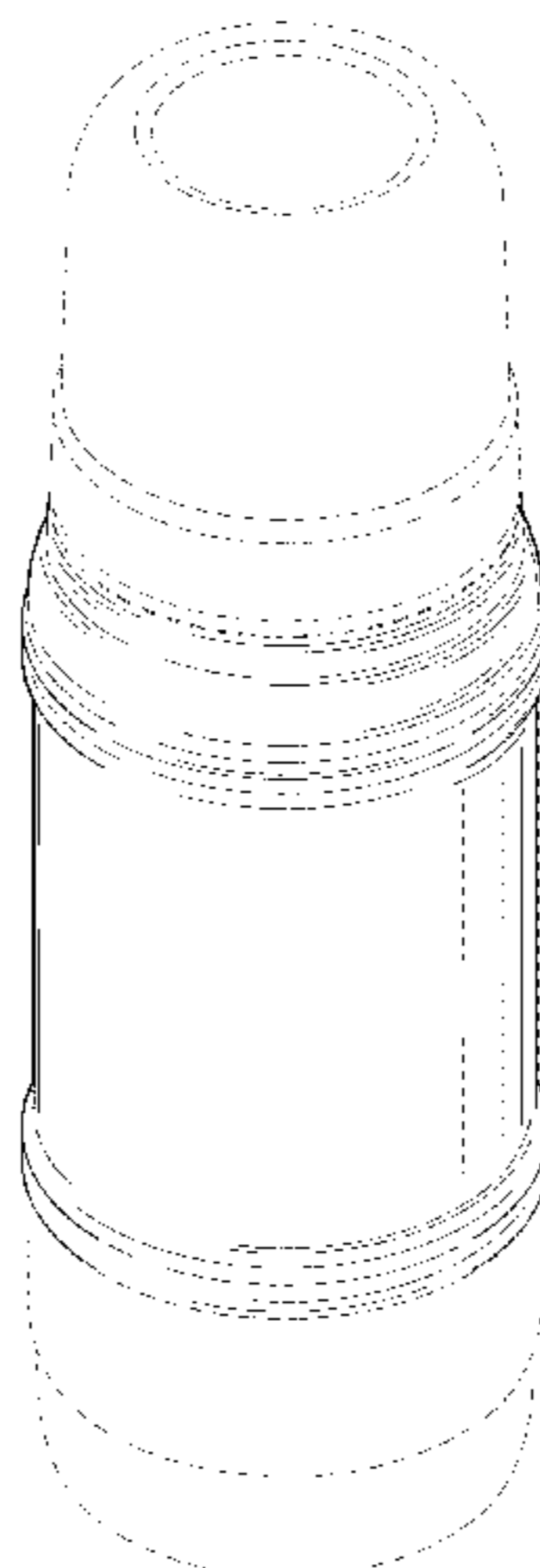

(58) **Field of Classification Search**
 CPC ... 41/0077; A47J 41/00; A47J 41/0088; F25D
 2331/803; F25D 3/08; A45C 11/20
 See application file for complete search history.

(56) **References Cited**

U.S. PATENT DOCUMENTS

4,344,303	A	8/1982	Kelly, Jr.	
4,462,444	A	7/1984	Larson	
4,615,463	A	10/1986	Price et al.	
D310,942	S	10/1990	Woodall	
4,966,303	A	10/1990	Jones	
D411,802	S *	7/1999	Hestehave	D9/500
D437,528	S *	2/2001	Kitamura	D7/608
6,332,557	B1 *	12/2001	Moran	A47J 41/0083 215/12.1
D454,034	S	3/2002	McLaughlin	
D495,875	S	9/2004	Spence, Jr.	
D518,380	S	4/2006	Moran	
D551,022	S	9/2007	Meehan	
D553,908	S	10/2007	Bonini	
D557,994	S	12/2007	Wahl	
D590,212	S	4/2009	Mancha, Jr. et al.	
D630,062	S *	1/2011	Carreno	D7/608
D639,114	S	6/2011	Swinford et al.	
D649,402	S	11/2011	Gilbert et al.	
D650,235	S	12/2011	Eyal	
D652,257	S *	1/2012	Kraemer	D7/523
D660,084	S	5/2012	Gilbert	

D660,655	S	5/2012	Wahl et al.	
D669,737	S *	10/2012	Nemeth	D7/532
D701,428	S	3/2014	Lapsker	
D709,736	S	7/2014	Gooding	
D718,980	S	12/2014	Lapsker	
D742,221	S	11/2015	Casiddu	
D742,699	S *	11/2015	Boroski	D7/608
D754,484	S *	4/2016	Lapsker	D7/532
D756,784	S *	5/2016	Fine	D9/500
D769,046	S *	10/2016	Beckman	B65D 25/28 D7/316
D784,763	S	4/2017	Oshana	
9,845,989	B1	12/2017	Veiga	
D809,347	S *	2/2018	Silsby	D7/608
D827,377	S *	9/2018	Silsby	D7/510
D829,057	S	9/2018	Agado	
10,959,553	B2 *	3/2021	Nichols	A47J 41/0027
D917,968	S	5/2021	Silsby	
2007/0241117	A1	10/2007	Szymanski	

OTHER PUBLICATIONS

U.S. Appl. No. 29/719,765, filed Jan. 7, 2020.
 U.S. Appl. No. 29/726,740, filed Mar. 5, 2020.
 U.S. Appl. No. 29/720,574, filed Jan. 14, 2020.
 U.S. Appl. No. 29/719,766, filed Jan. 7, 2020.
 U.S. Appl. No. 29/726,753, filed Mar. 5, 2020.
 U.S. Appl. No. 29/720,579, filed Jan. 14, 2020.
 U.S. Appl. No. 29/726,761, filed Mar. 5, 2020.

* cited by examiner

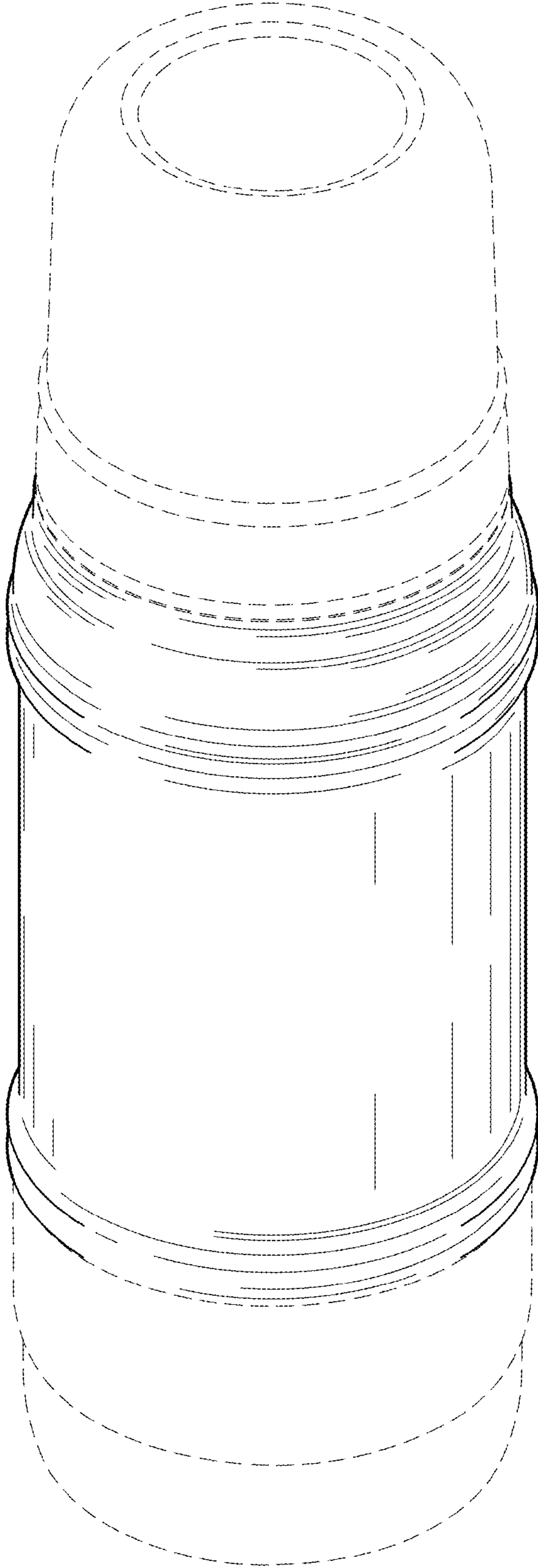

FIG. 1

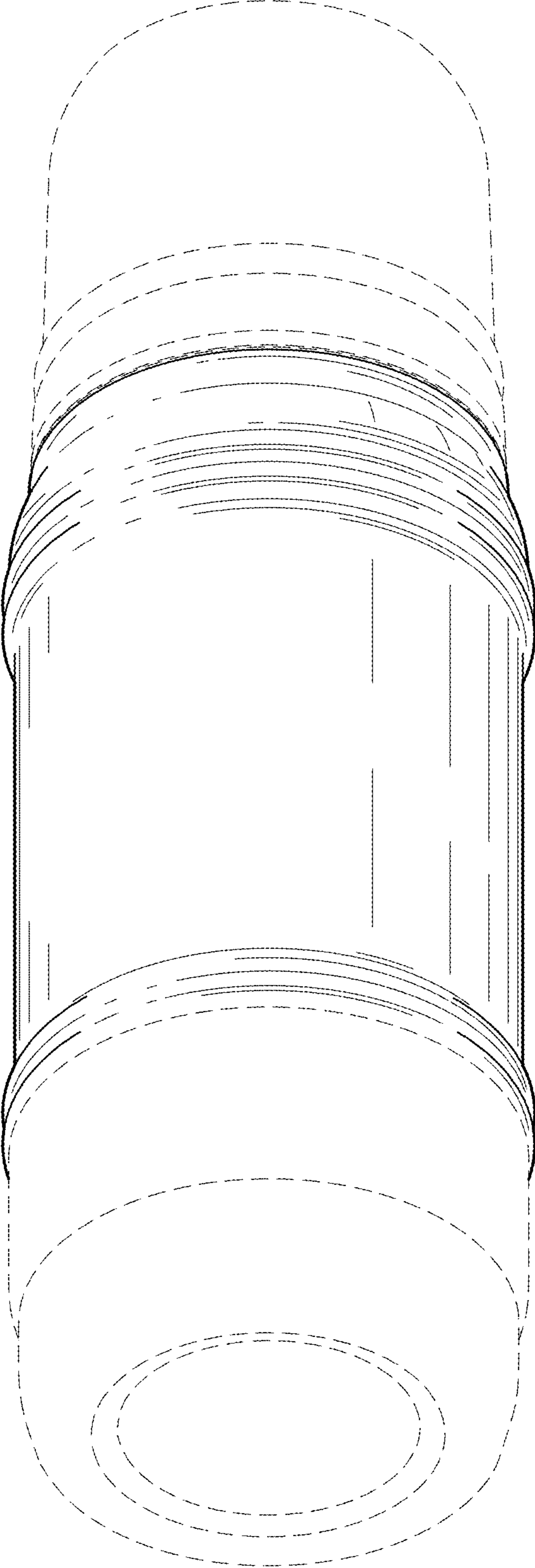

FIG. 2

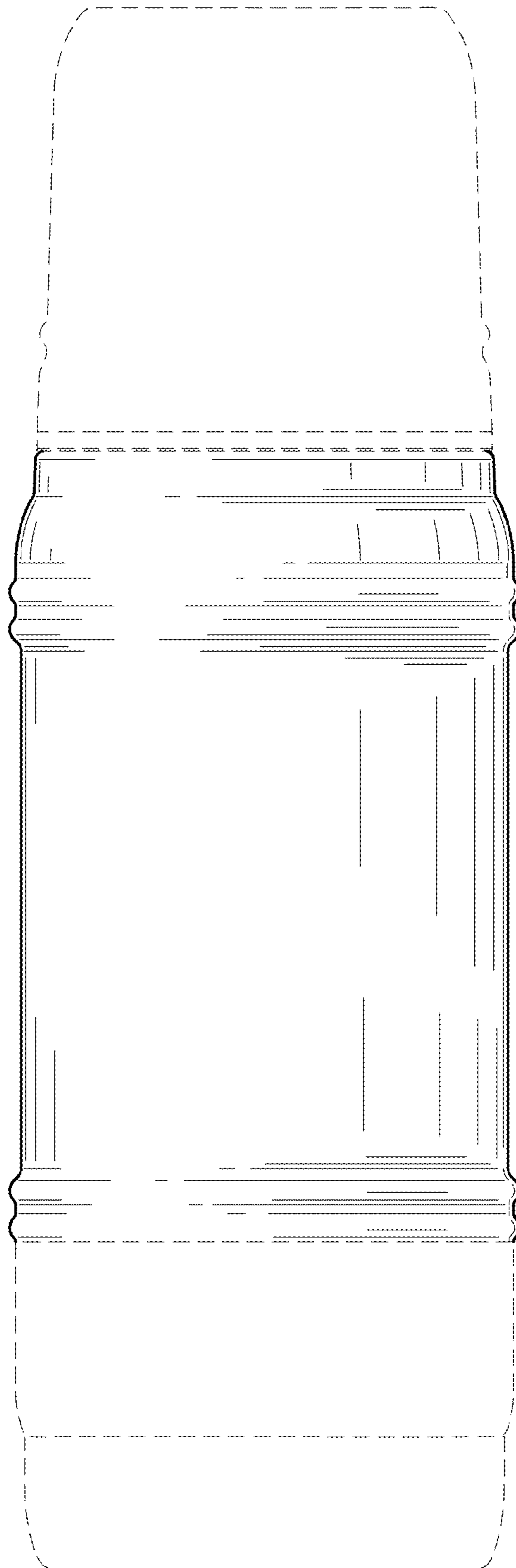

FIG. 3

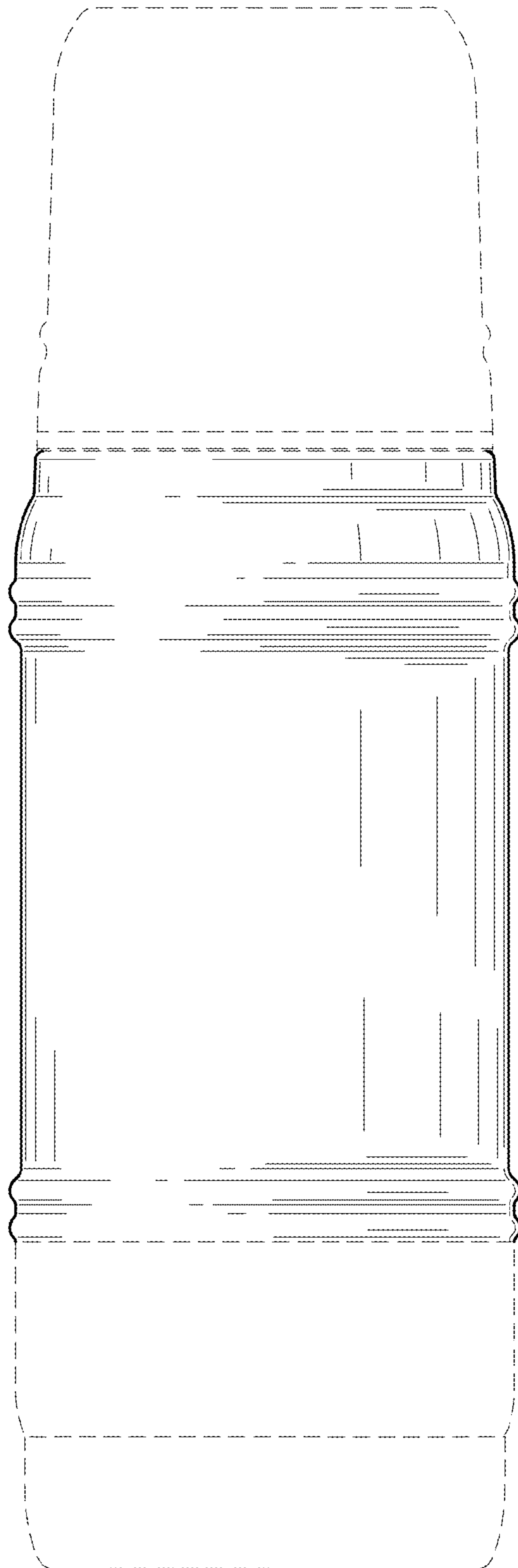

FIG. 4

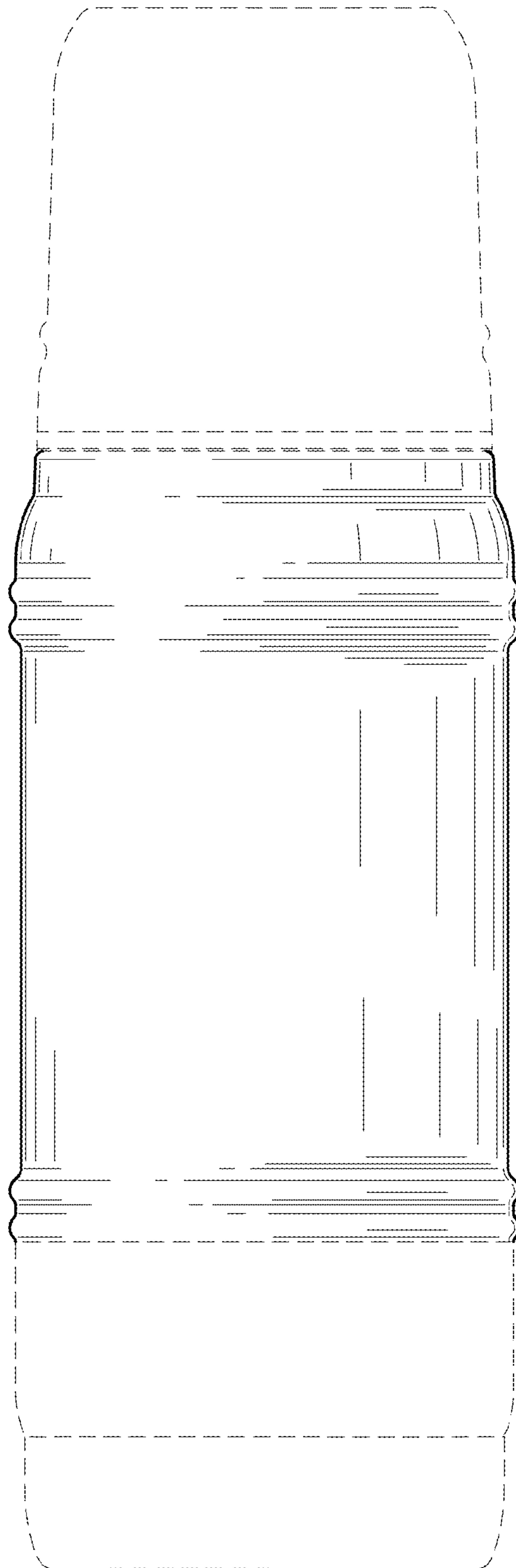

FIG. 5

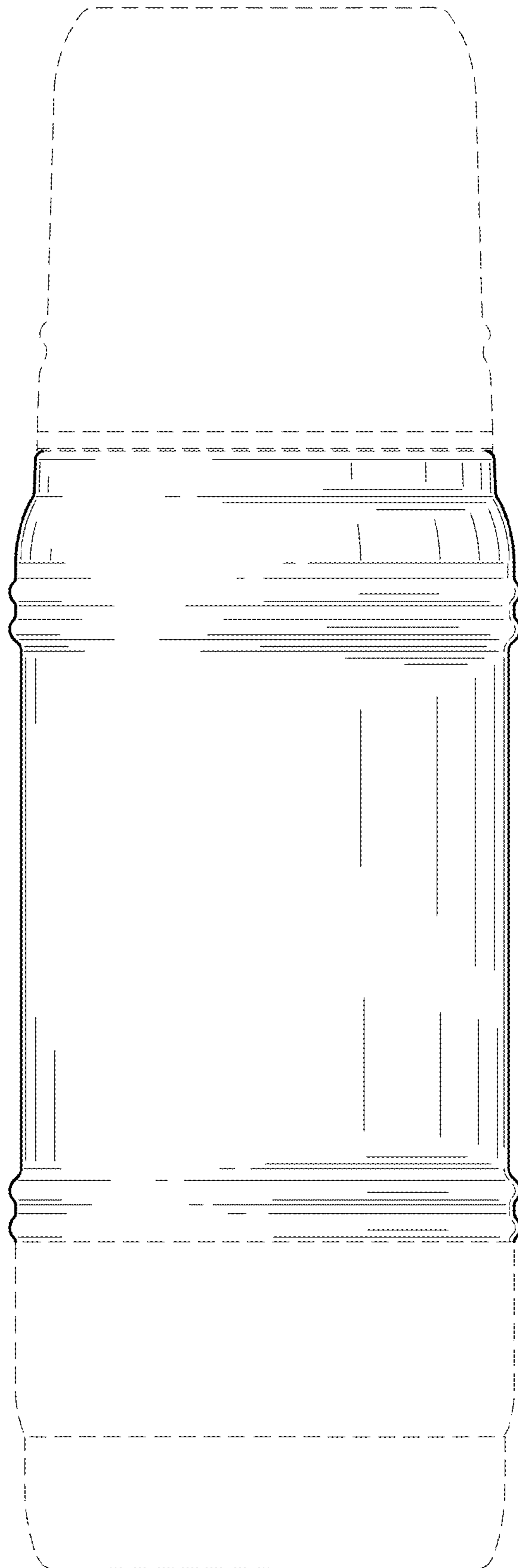

FIG. 6

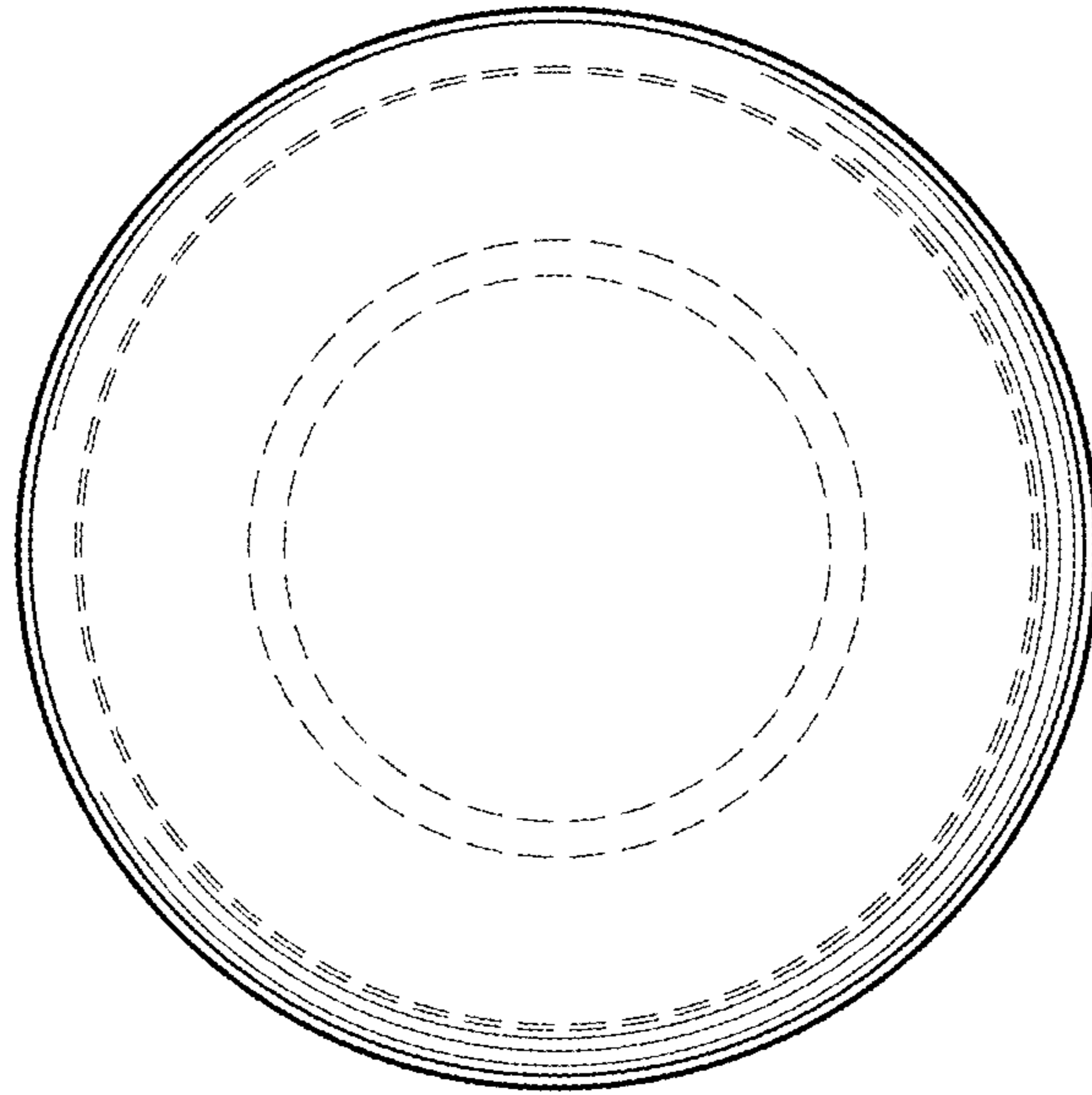

FIG. 7

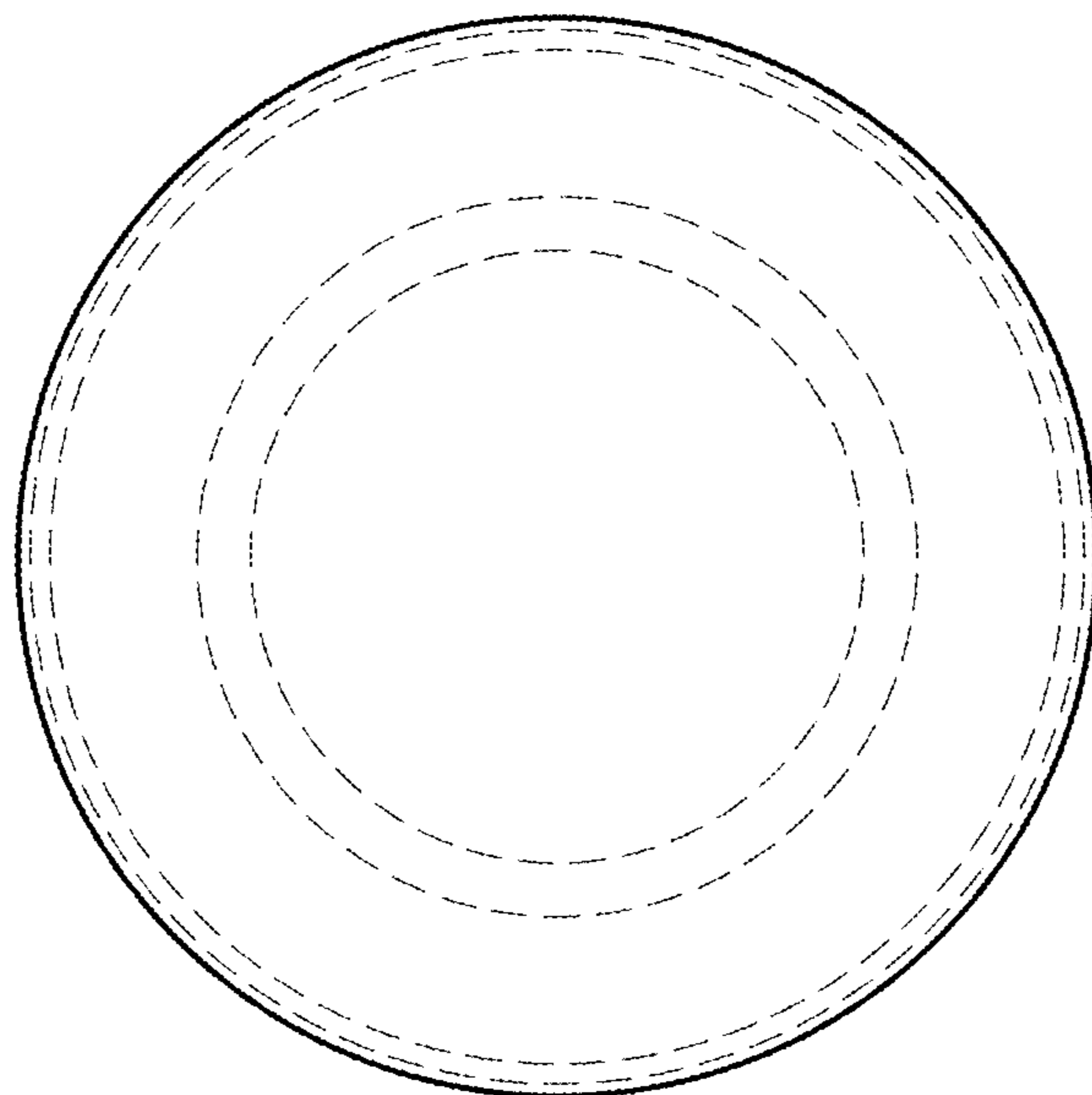

FIG. 8

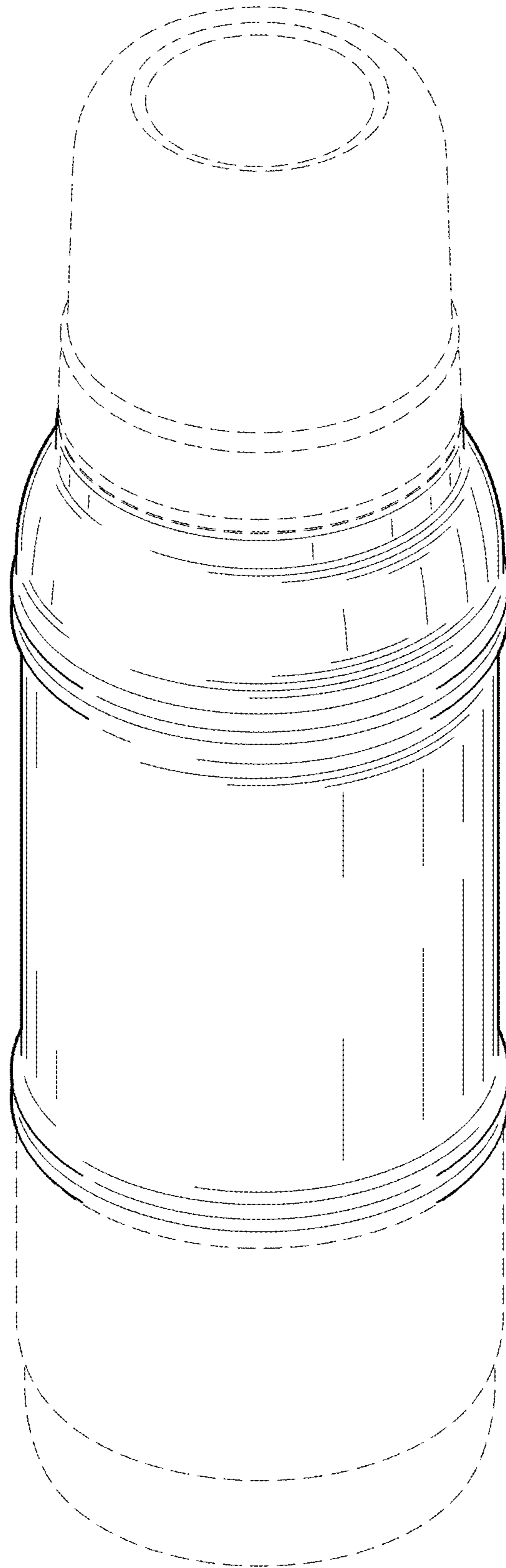

FIG. 9

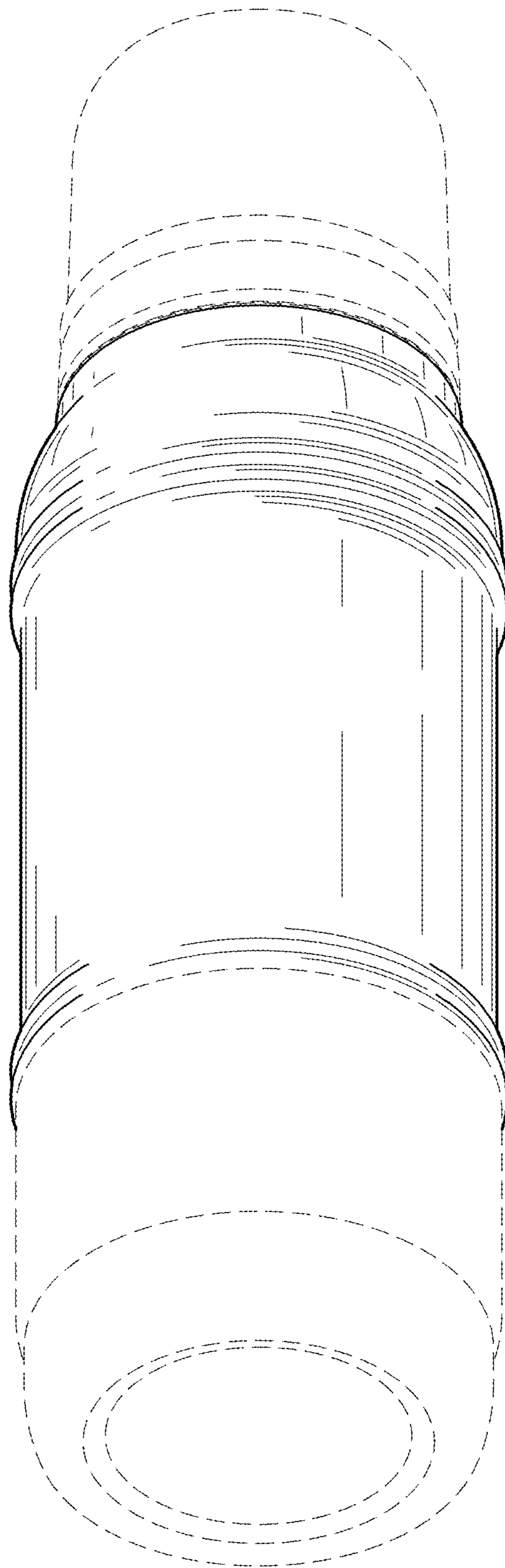

FIG. 10

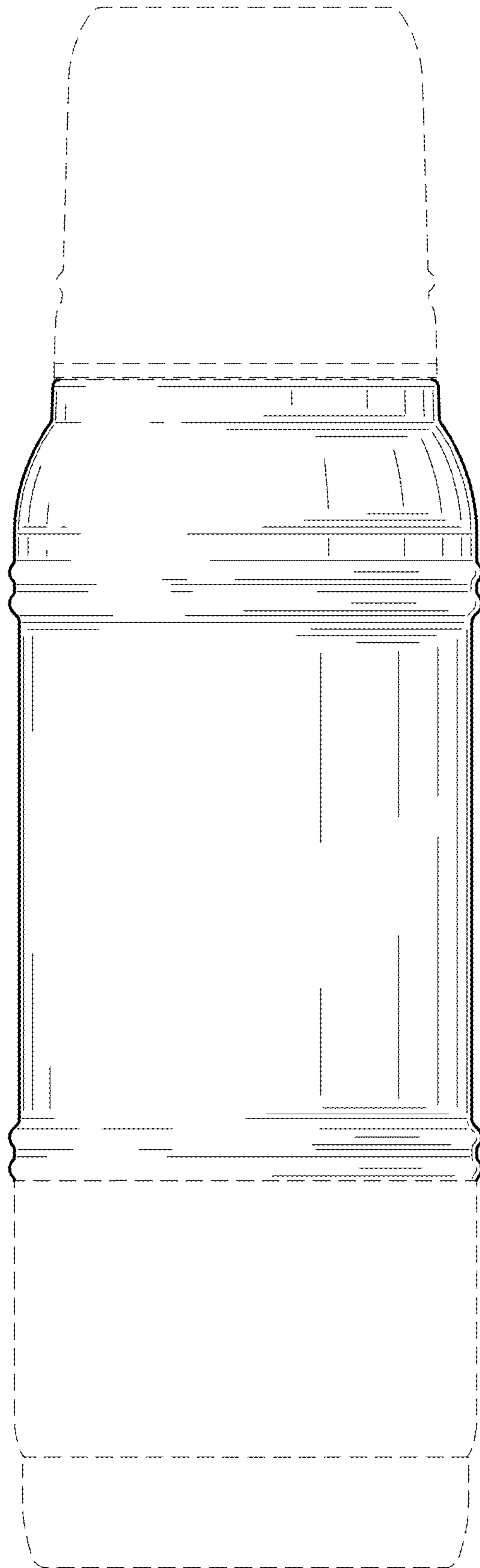

FIG. 11

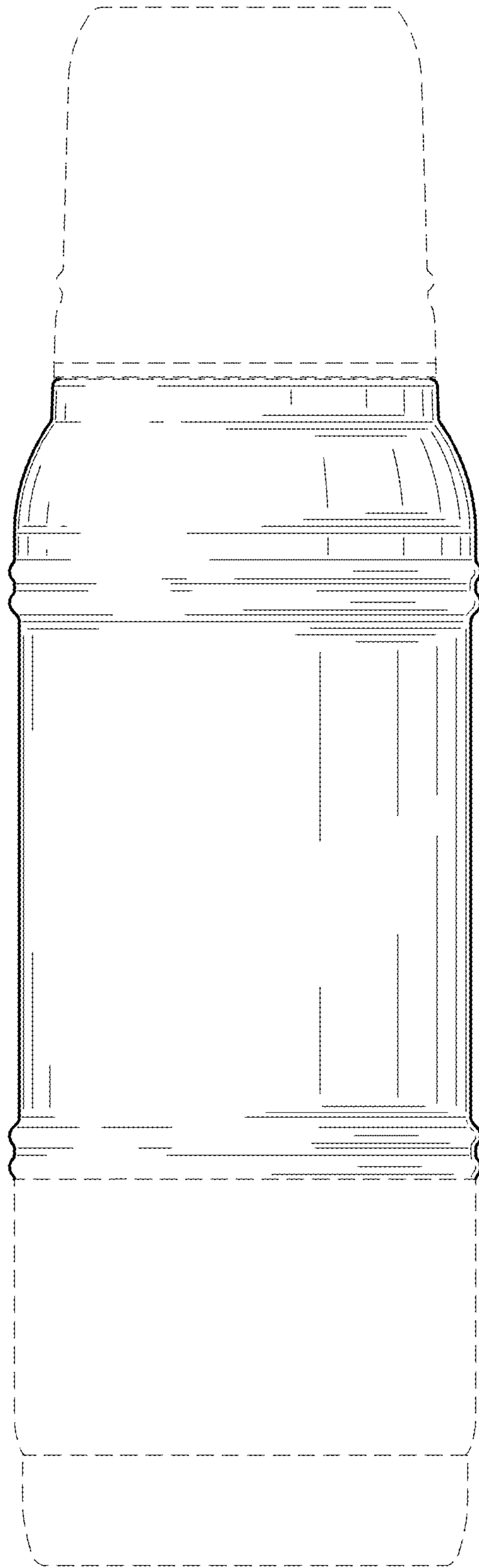

FIG. 12

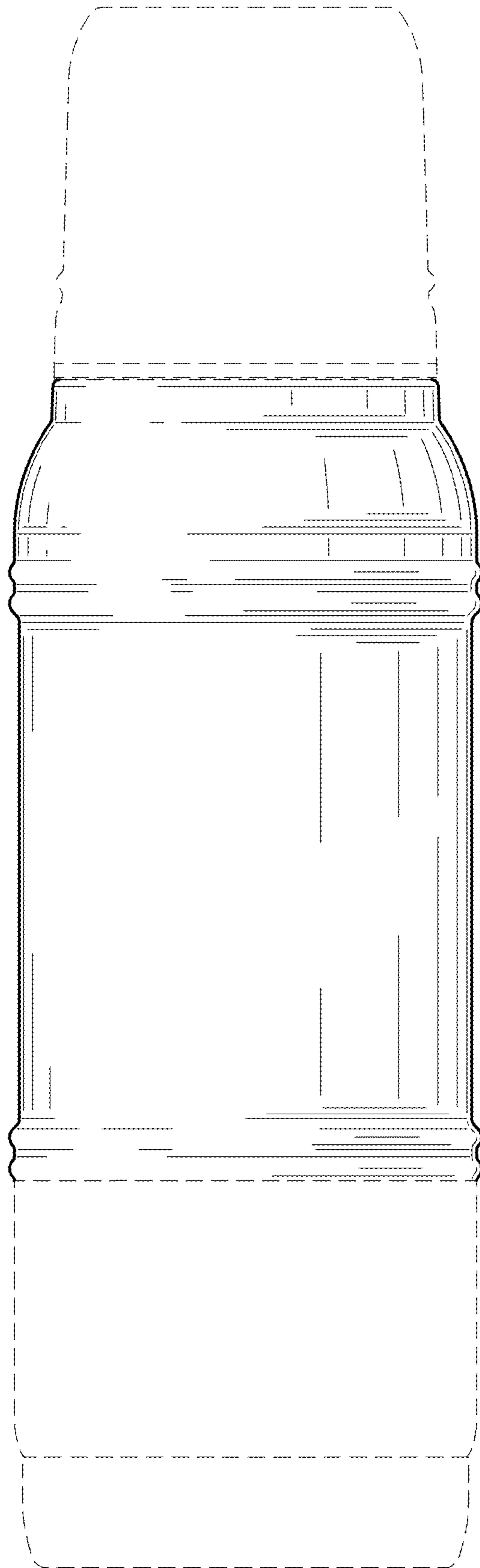

FIG. 13

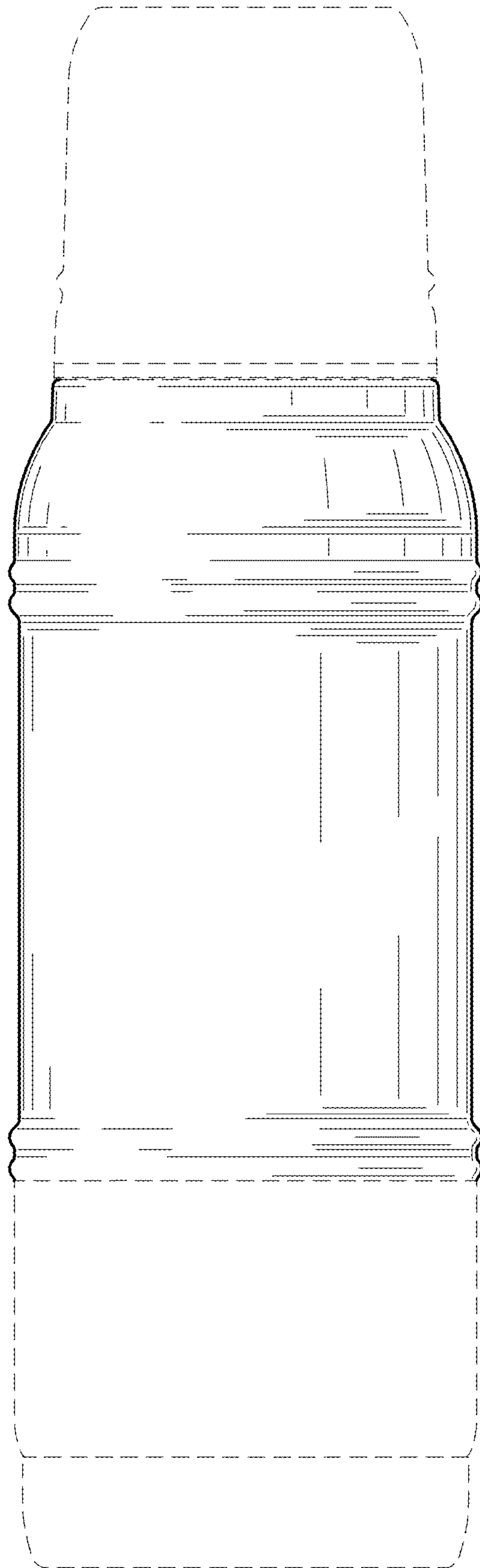

FIG. 14

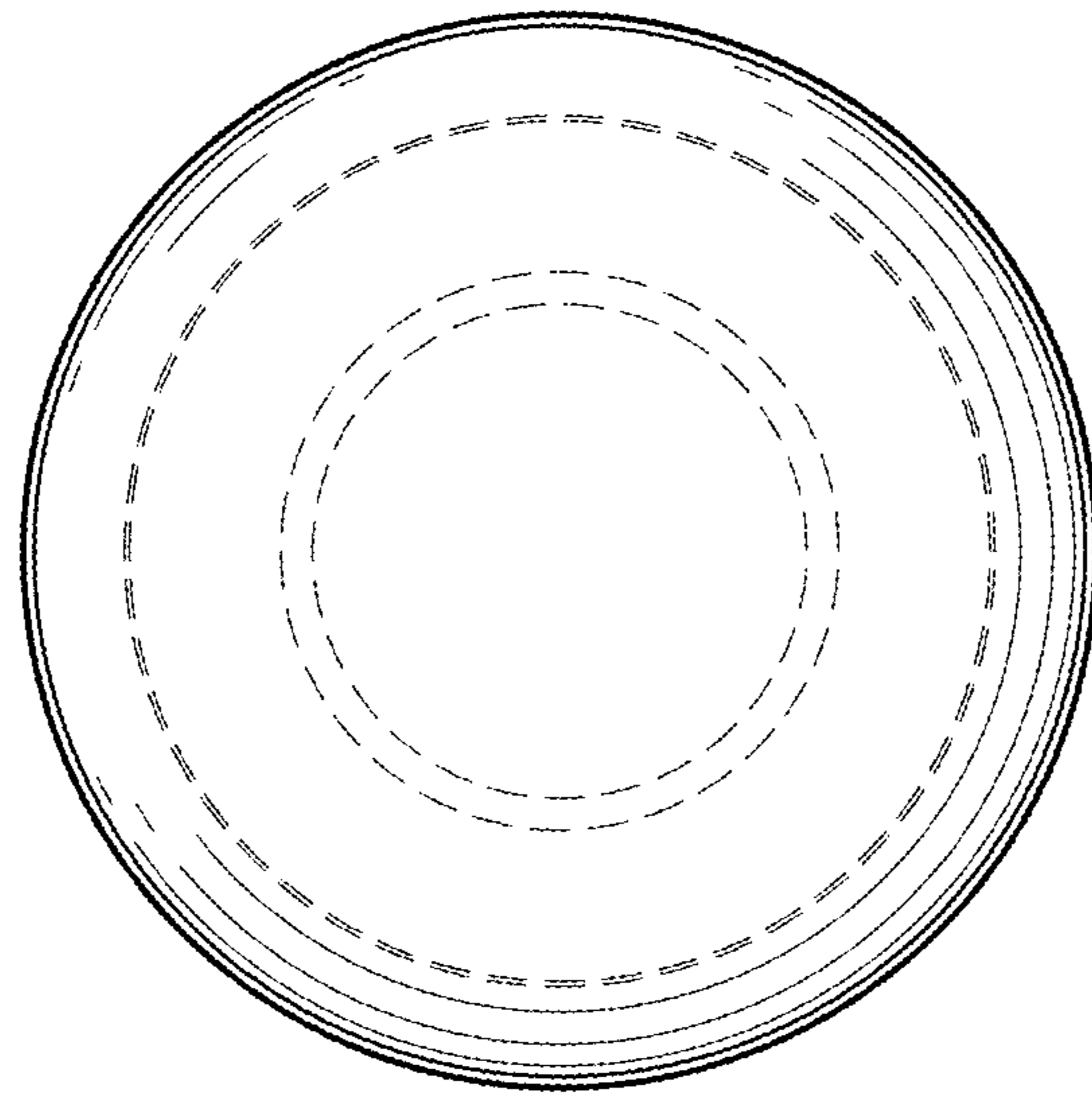

FIG. 15

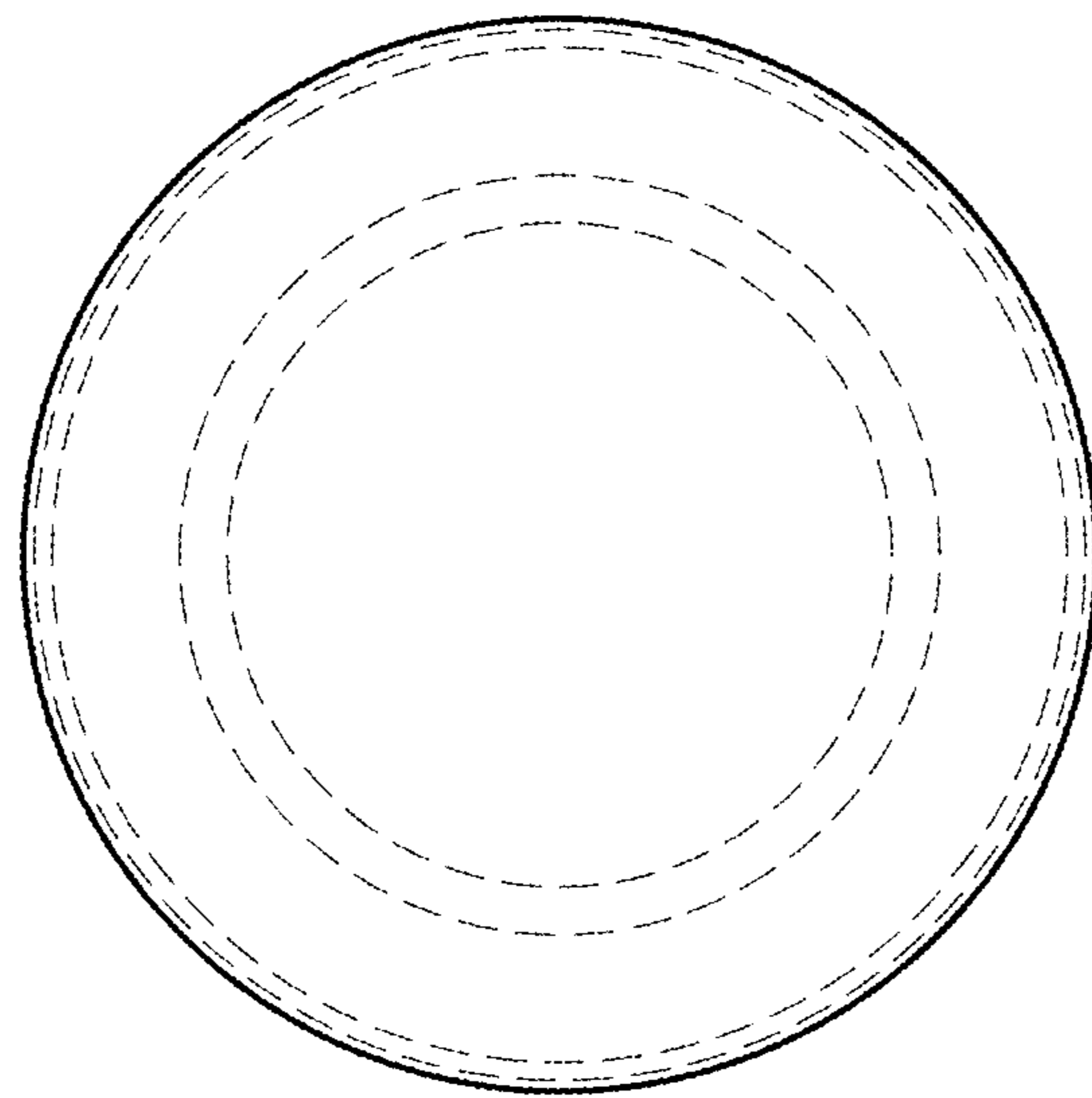

FIG. 16