



US00D949573S

(12) **United States Design Patent** (10) **Patent No.:** **US D949,573 S**  
**Zhao** (45) **Date of Patent:** **\*\* Apr. 26, 2022**

(54) **BRUSH HEAD**

FOREIGN PATENT DOCUMENTS

(71) Applicant: **Thumbs Up Innovations Technology Co., Ltd., Zhuhai (CN)**

CN 306887969 \* 10/2021  
CN 306959169 \* 11/2021  
KR 301136248.0000 \* 11/2021

(72) Inventor: **Yuqiang Zhao, Zhuhai (CN)**

OTHER PUBLICATIONS

(73) Assignee: **Thumbs Up Innovations Technology Co., Ltd., Zhuhai (CN)**

Yunchi Brush, announced Jan. 2019 [online], [site visited Jan. 15, 2022]. Available from internet, URL: <https://www.amazon.com/Toothbrush-Replacement-Compatible-YUNCHI-Toothbrushes/dp/B07MX5C9LK?th=1> (Year: 2019).\*

(\*\*) Term: **15 Years**

(21) Appl. No.: **29/747,268**

\* cited by examiner

(22) Filed: **Aug. 20, 2020**

*Primary Examiner* — Cynthia Ramirez

(30) **Foreign Application Priority Data**

*Assistant Examiner* — Tamara L Hahn

Jul. 6, 2020 (CN) ..... 202030359809.X

(74) *Attorney, Agent, or Firm* — ScienBizip, P.C.

(51) **LOC (13) Cl.** ..... **04-02**

(57) **CLAIM**

(52) **U.S. Cl.**  
USPC ..... **D4/111**

The ornamental design for a brush head, as shown and described.

(58) **Field of Classification Search**  
USPC ..... D4/100–138, 199; D24/176, 181  
CPC .... A46B 2200/1066; A46B 2200/1073; A46B 2200/1086; A46B 9/04; A46B 9/028; A46B 5/0095; A61C 17/16; A63H 13/00  
See application file for complete search history.

**DESCRIPTION**

(56) **References Cited**

FIG. 1 is a front perspective view of a brush head, showing my design.  
FIG. 2 is a front elevation view thereof.  
FIG. 3 is a rear elevation view thereof.  
FIG. 4 is a left side elevation view thereof.  
FIG. 5 is a right side elevation view thereof.  
FIG. 6 is a top plan view thereof; and,  
FIG. 7 is a bottom plan view thereof.  
The broken lines in the drawings depict portions of the brush head that form no part of the claimed design.

U.S. PATENT DOCUMENTS

D866,188 S \* 11/2019 Wagner ..... A61C 17/02 D4/101  
D933,963 S \* 10/2021 He ..... D4/101  
D933,964 S \* 10/2021 He ..... D4/101  
D935,192 S \* 11/2021 He ..... D4/101  
D935,193 S \* 11/2021 He ..... D4/101

**1 Claim, 6 Drawing Sheets**

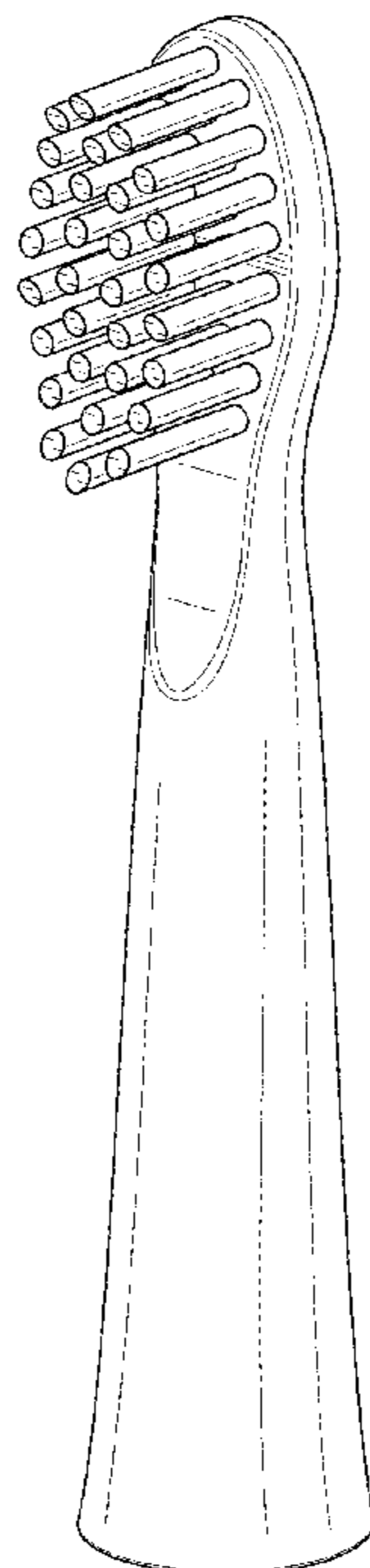

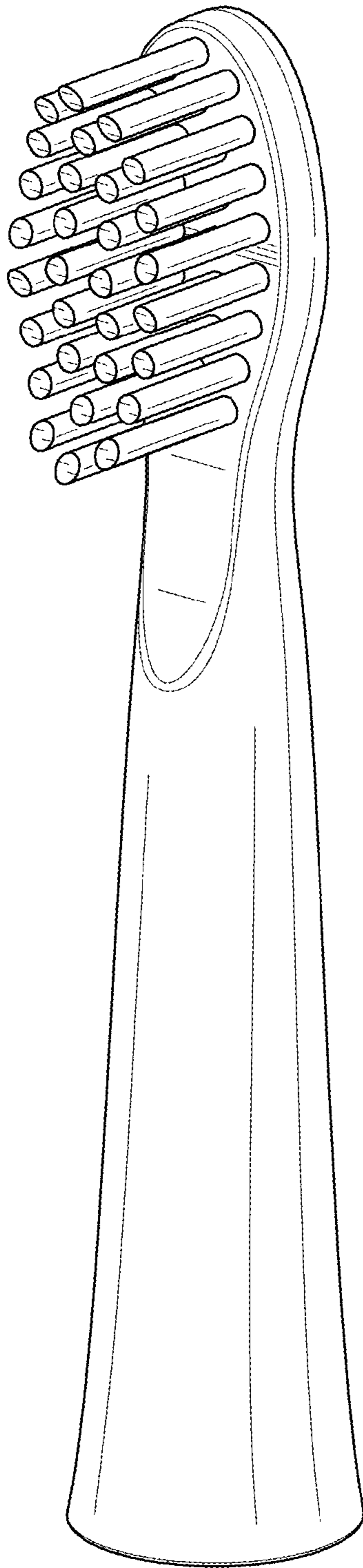

FIG.1

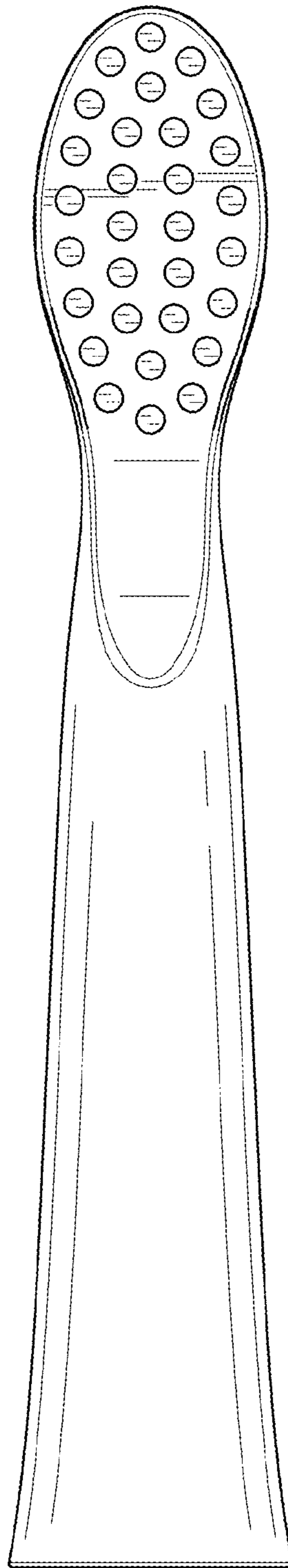

FIG.2

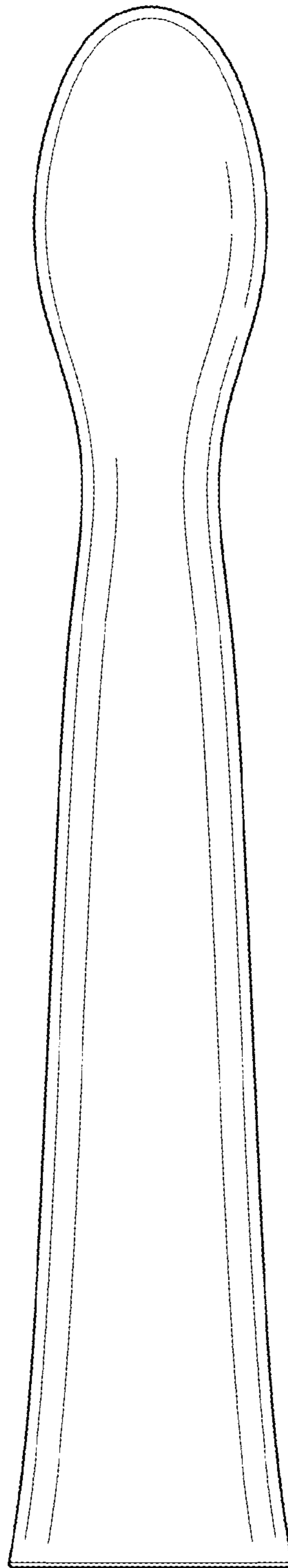

FIG.3

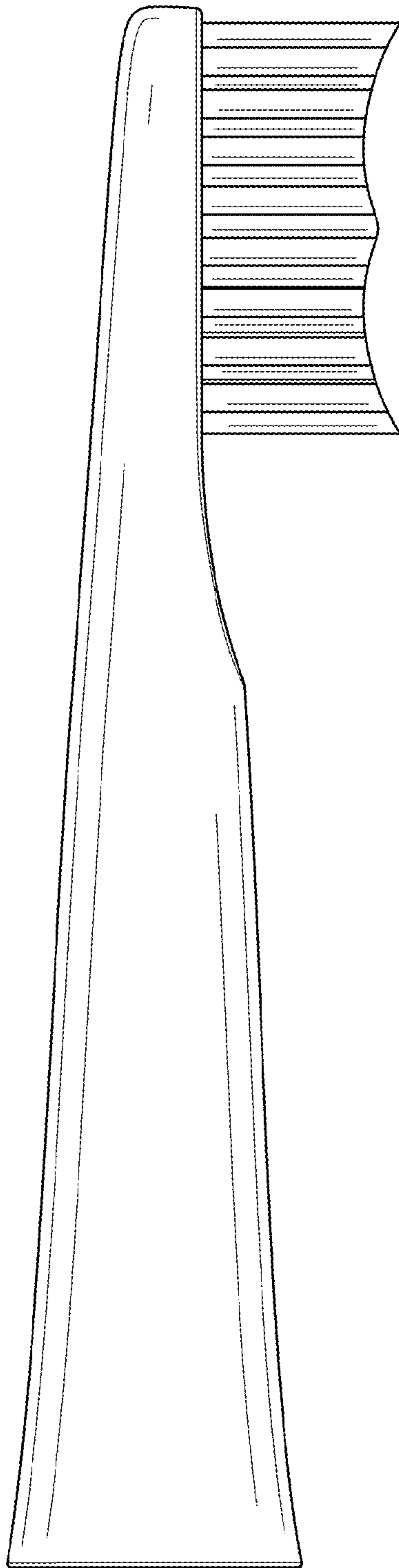

FIG. 4

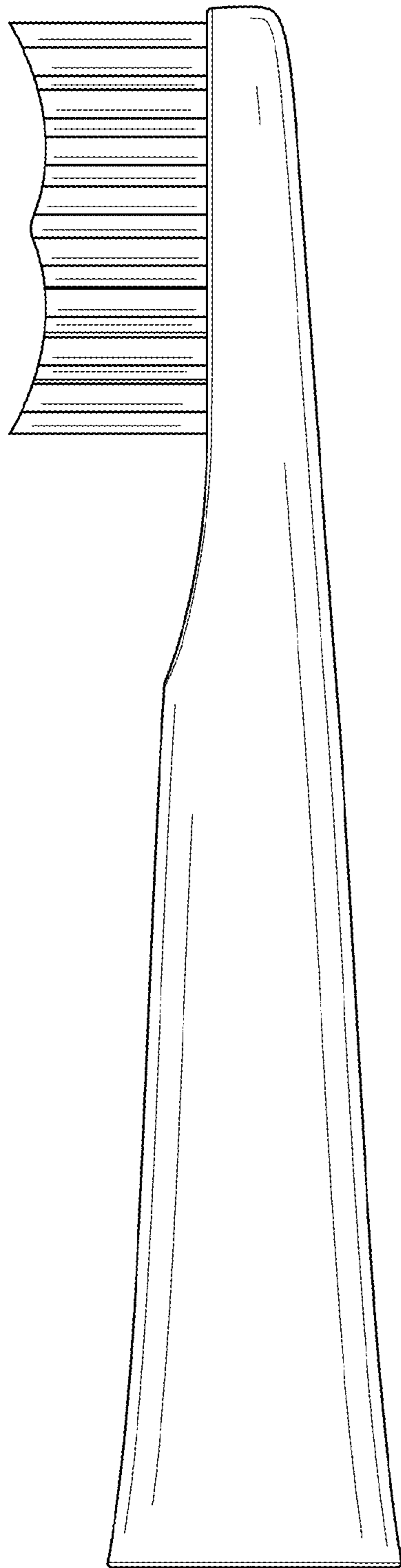

FIG. 5

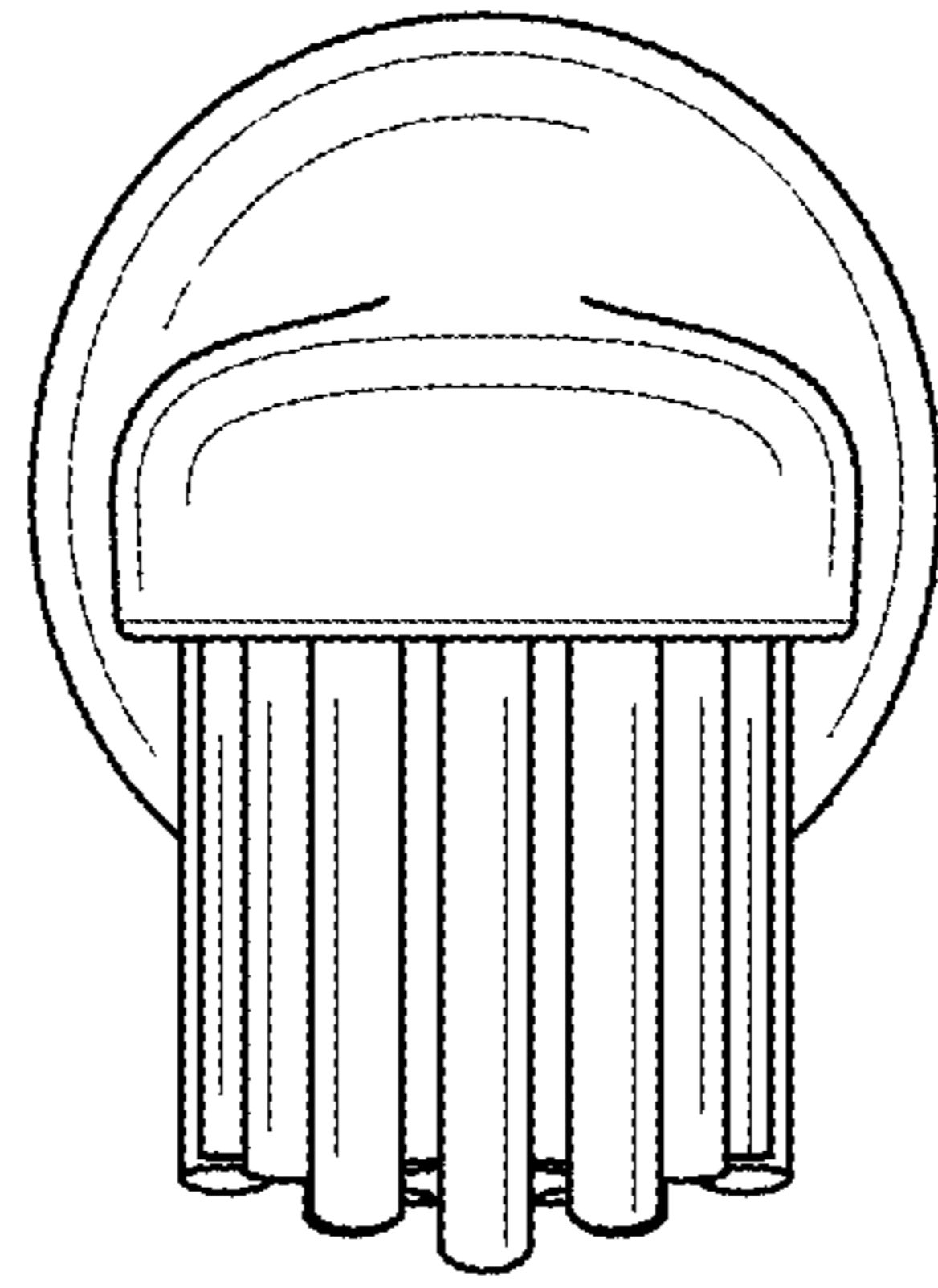

FIG. 6

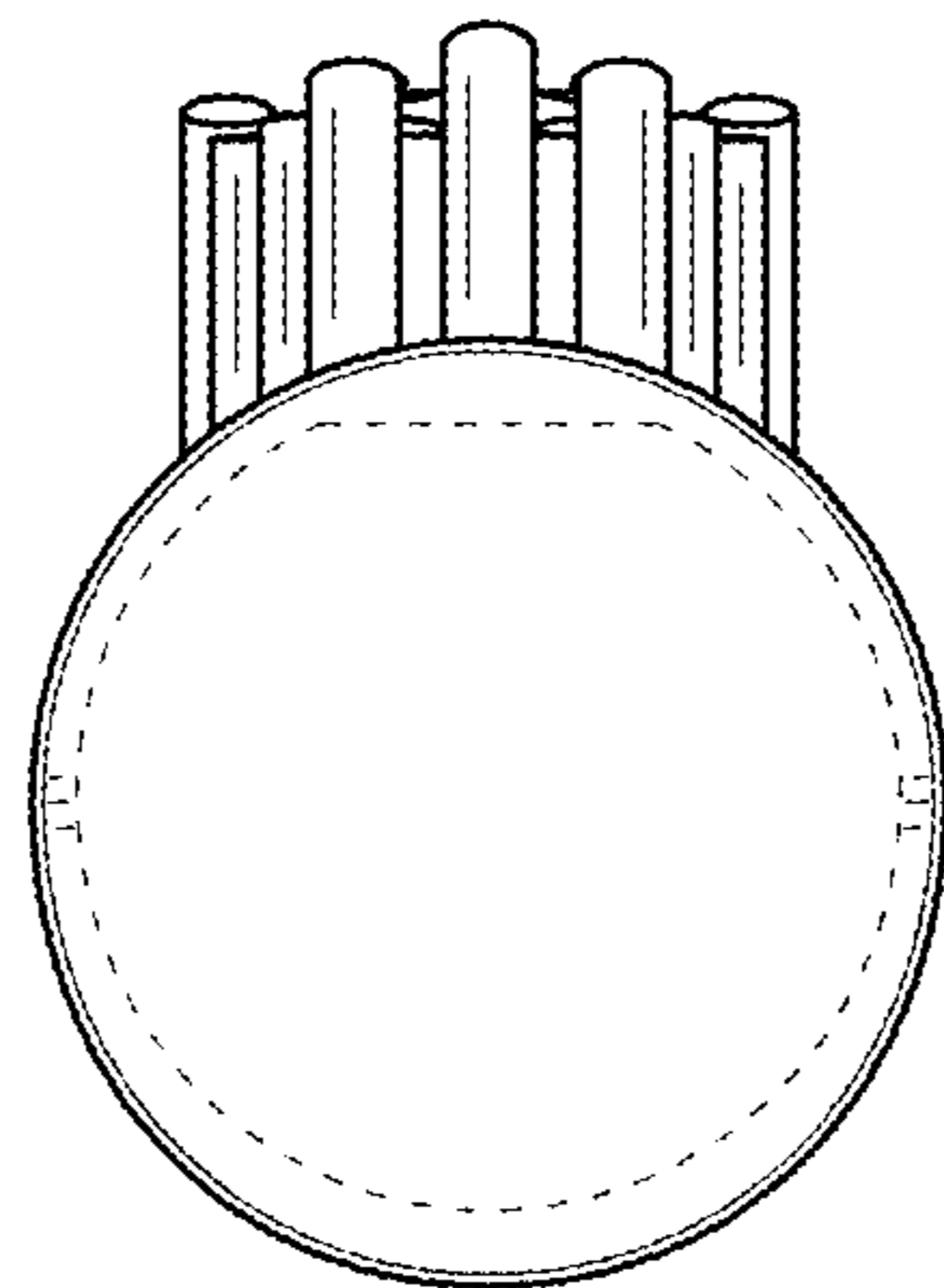

FIG. 7