



US00D949479S

(12) **United States Design Patent** (10) **Patent No.:** **US D949,479 S**
Van Roosmalen et al. (45) **Date of Patent:** **** Apr. 19, 2022**

(54) **HANDLE FOR SHAVER**

(57) **CLAIM**

The ornamental design for a handle for shaver, as shown and described.

(71) Applicant: **KONINKLIJKE PHILIPS N.V.**,
Eindhoven (NL)

DESCRIPTION

(72) Inventors: **Jos Van Roosmalen**, Amsterdam (NL);
Frank Verbrugge, Rosmalen (NL);
Jens Andersson, Amsterdam (NL);
Roel Krooshof, Bilthoven (NL); **Simon**
Van Anken, Amsterdam (NL); **Peter**
Gal, Amsterdam (NL); **Lieven**
Adriaenssen, Vilvoorde (BE); **Roshan**
Hakim, Amsterdam (NL); **Mingshuo**
Zhang, Amstelveen (NL)

FIG. 1 is a perspective view showing the first embodiment of a handle for shaver;
FIG. 2 is a front elevational view thereof;
FIG. 3 is a rear elevational view thereof;
FIG. 4 is a right side elevational view thereof;
FIG. 5 is a left side elevational view thereof;
FIG. 6 is a top plan view thereof;
FIG. 7 is a bottom plan view thereof;
FIG. 8 is a perspective view showing the second embodiment of a handle for shaver;
FIG. 9 is a front elevational view thereof;
FIG. 10 is a rear elevational view thereof;
FIG. 11 is a right side elevational view thereof;
FIG. 12 is a left side elevational view thereof;
FIG. 13 is a top plan view thereof;
FIG. 14 is a bottom plan view thereof;
FIG. 15 is a perspective view showing the third embodiment of a handle for shaver;
FIG. 16 is a front elevational view thereof;
FIG. 17 is a rear elevational view thereof;
FIG. 18 is a right side elevational view thereof;
FIG. 19 is a left side elevational view thereof;
FIG. 20 is a top plan view thereof;
FIG. 21 is a bottom plan view thereof;
FIG. 22 is a perspective view showing the fourth embodiment of a handle for shaver;
FIG. 23 is a front elevational view thereof;
FIG. 24 is a rear elevational view thereof;
FIG. 25 is a right side elevational view thereof;
FIG. 26 is a left side elevational view thereof;
FIG. 27 is a top plan view thereof;
FIG. 28 is a bottom plan view thereof;
FIG. 29 is a perspective view showing the fifth embodiment of a handle for shaver;
FIG. 30 is a front elevational view thereof;
FIG. 31 is a rear elevational view thereof;
FIG. 32 is a right side elevational view thereof;
FIG. 33 is a left side elevational view thereof;
FIG. 34 is a top plan view thereof; and,
FIG. 35 is a bottom plan view thereof.
The broken lines illustrate portions of the handle for shaver that form no part of the claimed design.

(73) Assignee: **KONINKLIJKE PHILIPS N.V.**,
Eindhoven (NL)

(**) Term: **15 Years**

(21) Appl. No.: **29/723,332**

(22) Filed: **Feb. 6, 2020**

(30) **Foreign Application Priority Data**

Aug. 21, 2019 (EM) 006747143

(51) **LOC (13) Cl.** **28-03**

(52) **U.S. Cl.**
USPC **D28/50; D28/54**

(58) **Field of Classification Search**
USPC D28/50
(Continued)

(56) **References Cited**

U.S. PATENT DOCUMENTS

D326,738 S * 6/1992 Mauro D28/50
D389,276 S * 1/1998 Bone D28/50
(Continued)

Primary Examiner — Jennifer Rivard

1 Claim, 20 Drawing Sheets

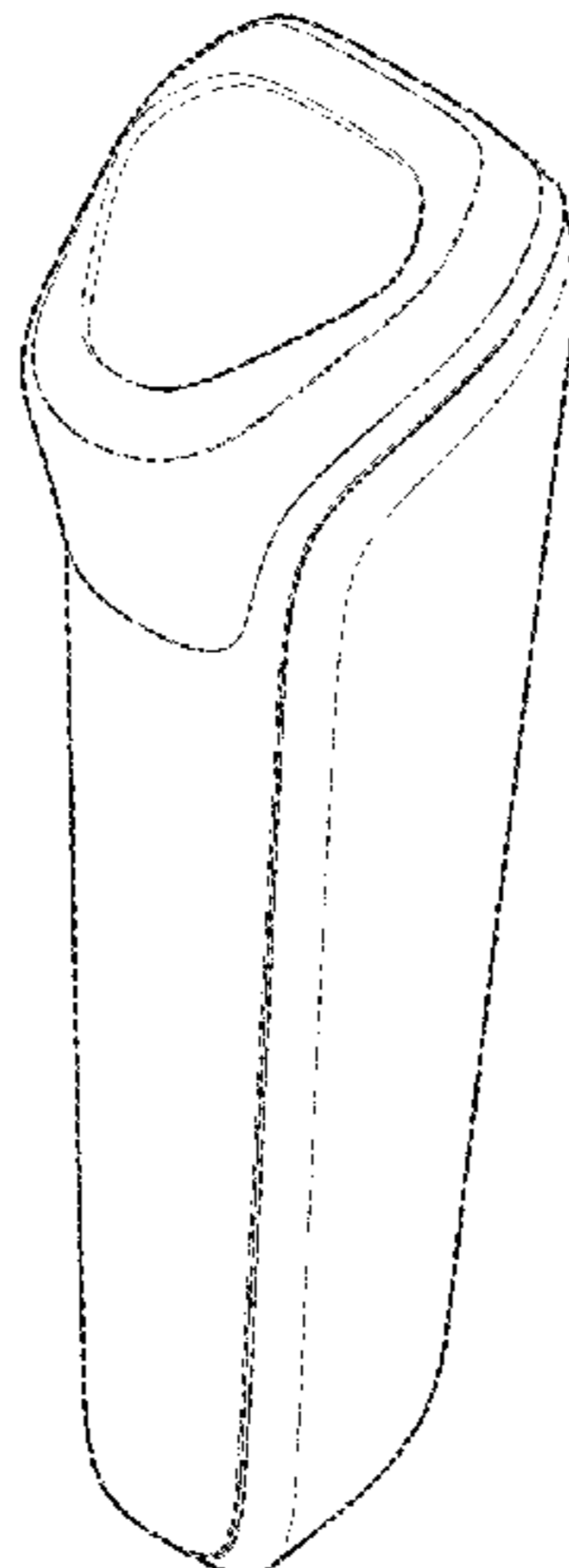

- (58) **Field of Classification Search**
 CPC B26B 19/14–18; B26B 19/3853–3866;
 B26B 19/3873–3886
 See application file for complete search history.

(56) **References Cited**

U.S. PATENT DOCUMENTS

D405,922 S *	2/1999	Bone	D28/50
D513,342 S *	12/2005	Sulik	D28/50
D520,681 S *	5/2006	Beedham	D28/50
D520,682 S *	5/2006	Butcher	D28/50
D542,473 S *	5/2007	McLachlan	D28/50
D544,999 S *	6/2007	Prat-Pfister	D28/50
D546,001 S *	7/2007	McLachlan	D28/50
D549,873 S *	8/2007	Prat-Pfister	D28/50
D550,901 S *	9/2007	Massee	D28/50
D563,599 S *	3/2008	Prat-Pfister	D28/50
D593,252 S *	5/2009	Masuda	D28/50
D601,301 S *	9/2009	Bao	D28/50
D604,013 S *	11/2009	Qiu	D28/50
D608,053 S *	1/2010	Vetu	D28/50
D620,198 S *	7/2010	Nitz	D28/50
D620,641 S *	7/2010	Nitz	D28/50
D620,642 S *	7/2010	Nitz	D28/50
D637,759 S *	5/2011	Byun	D28/50
D651,746 S *	1/2012	Prat-Pfister	D28/50
D654,223 S *	2/2012	Aulwes	D28/50
D675,779 S *	2/2013	Vetu	D28/50
D695,961 S *	12/2013	Prat-Pfister	D28/50
D695,962 S *	12/2013	Prat-Pfister	D28/50

D698,491 S *	1/2014	Ellison	D28/50
D737,514 S *	8/2015	Roland	D28/50
D737,515 S *	8/2015	Roland	D28/50
D738,042 S *	9/2015	Roland	D28/50
D748,857 S *	2/2016	Boulanger	D28/50
D758,014 S *	5/2016	Smith	D28/50
D758,015 S *	5/2016	Prat-Pfister	D28/50
D758,017 S *	5/2016	Smith	D28/54
D758,659 S *	6/2016	Smith	D28/50
D758,660 S *	6/2016	Prat-Pfister	D28/50
D776,348 S *	1/2017	Frankel	D28/50
D777,375 S *	1/2017	Frankel	D28/50
D777,376 S *	1/2017	Frankel	D28/50
D808,077 S *	1/2018	Boulanger	D28/50
D808,591 S *	1/2018	Prat-Pfister	D28/50
D812,301 S *	3/2018	Yan	D28/50
D819,274 S *	5/2018	Yan	D28/50
D821,032 S *	6/2018	Prat-Pfister	D28/50
D824,103 S *	7/2018	Yan	D28/50
D824,595 S *	7/2018	Yan	D28/50
D844,242 S *	3/2019	Yan	D28/50
D844,243 S *	3/2019	Chen	D28/50
D848,071 S *	5/2019	Prat-Pfister	D28/50
D848,072 S *	5/2019	Prat-Pfister	D28/50
D856,583 S *	8/2019	Chen	D28/50
D858,880 S *	9/2019	Lu	D28/50
D858,881 S *	9/2019	Lu	D28/50
D861,986 S *	10/2019	Wang	D28/50
D880,064 S *	3/2020	Andersson	D28/50
D884,972 S *	5/2020	Andersson	D28/50
D889,042 S *	6/2020	Andersson	D28/50
D902,486 S *	11/2020	Andersson	D28/50

* cited by examiner

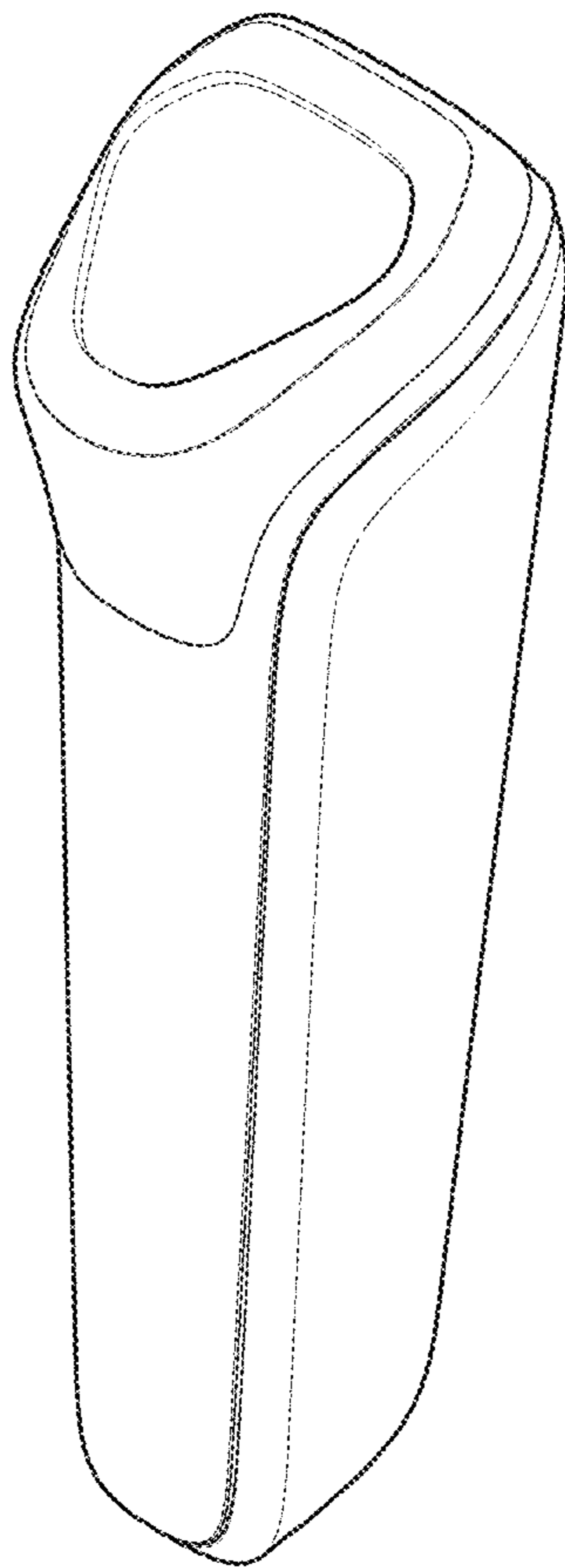

FIG. 1

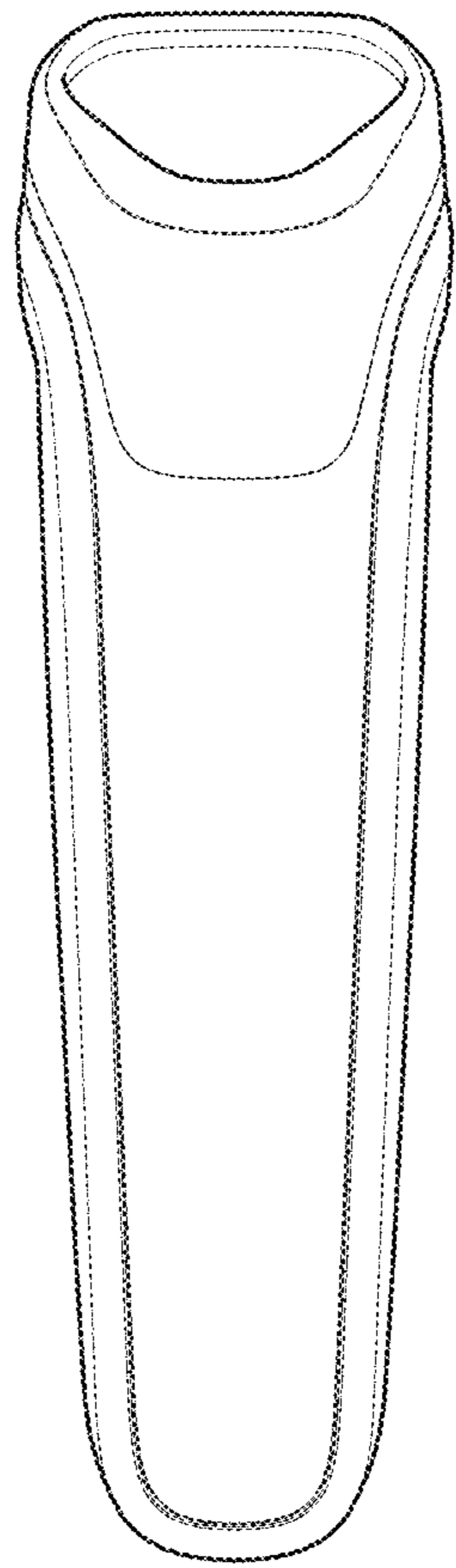

FIG. 2

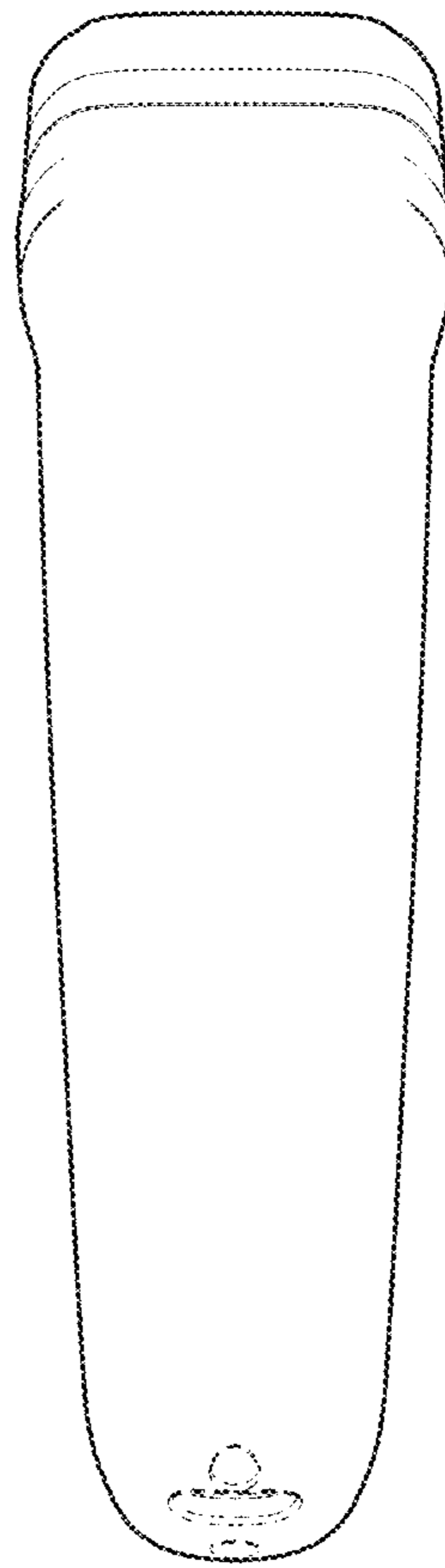

FIG. 3

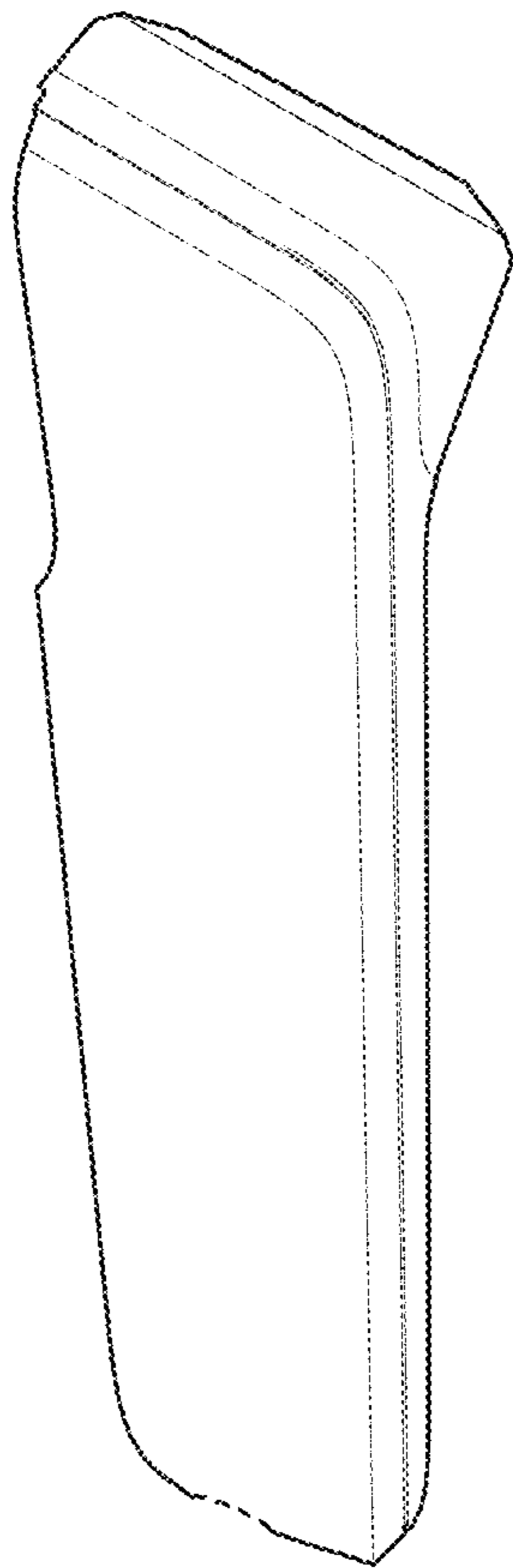

FIG. 4

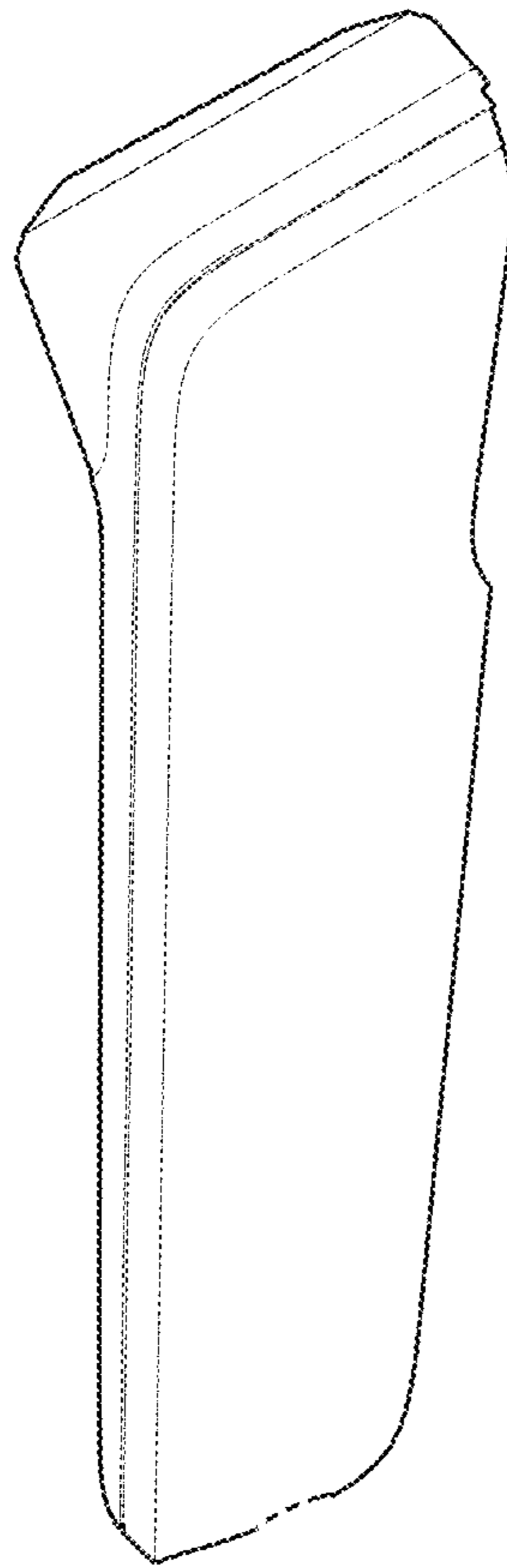

FIG. 5

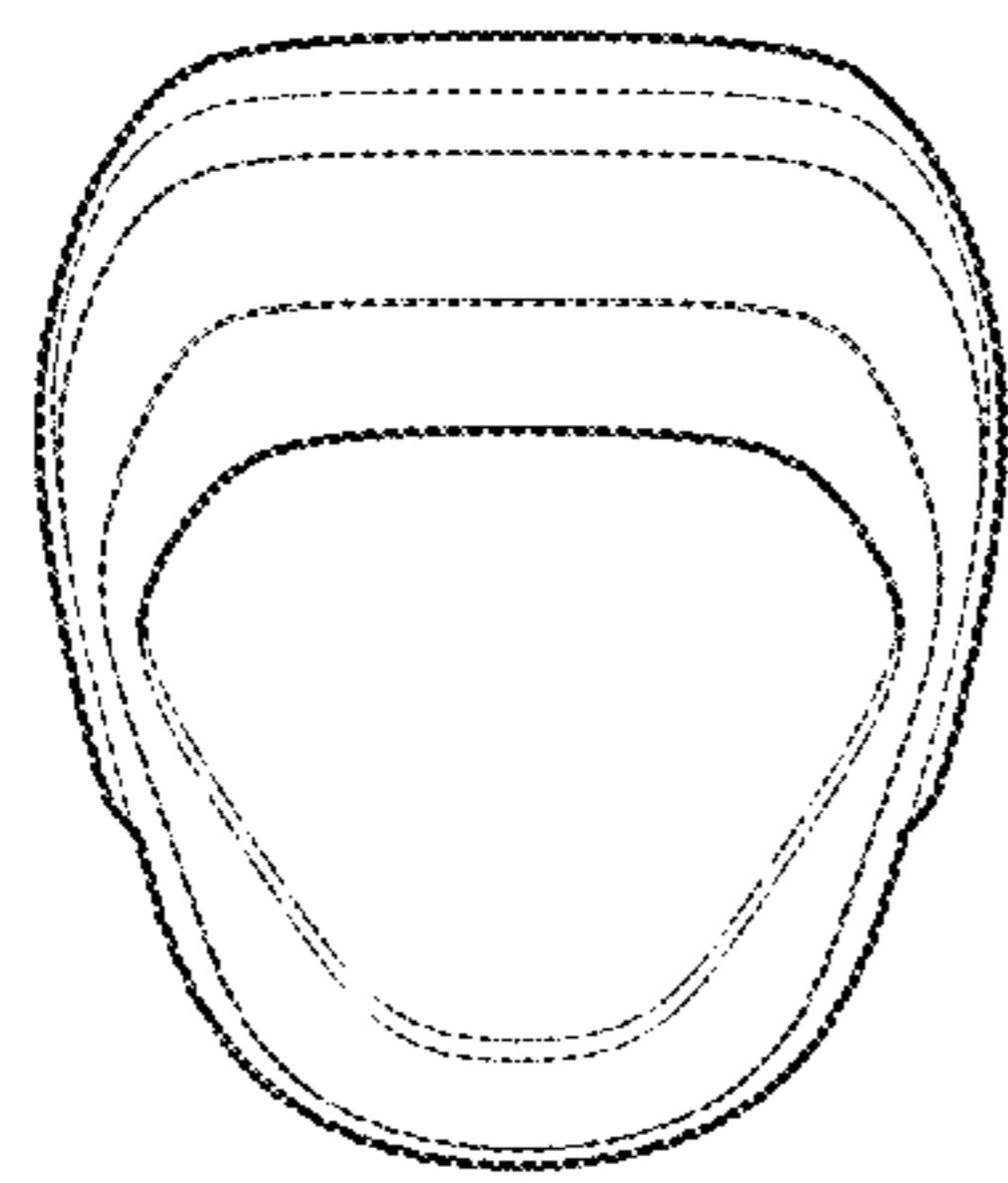

FIG. 6

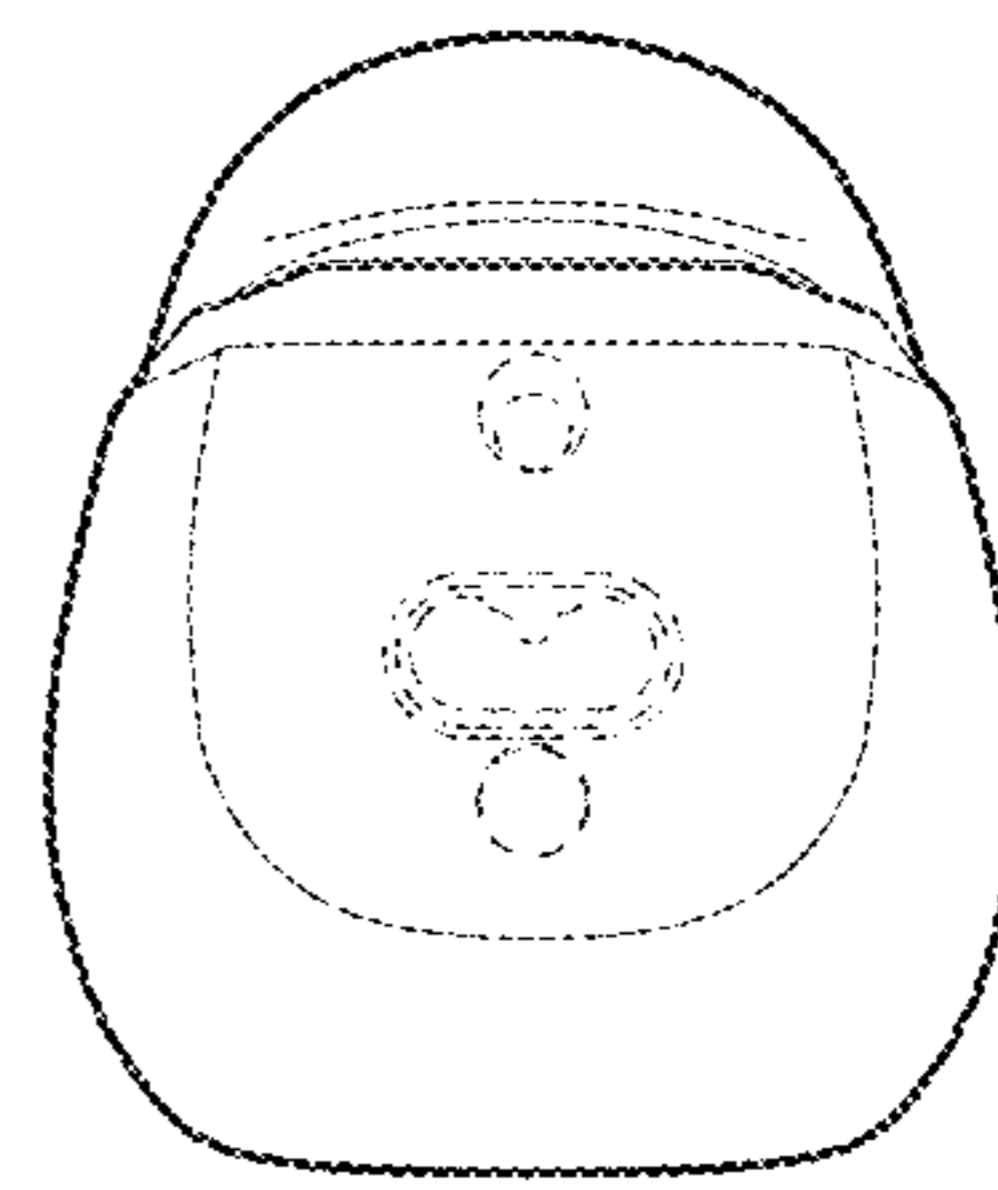

FIG. 7

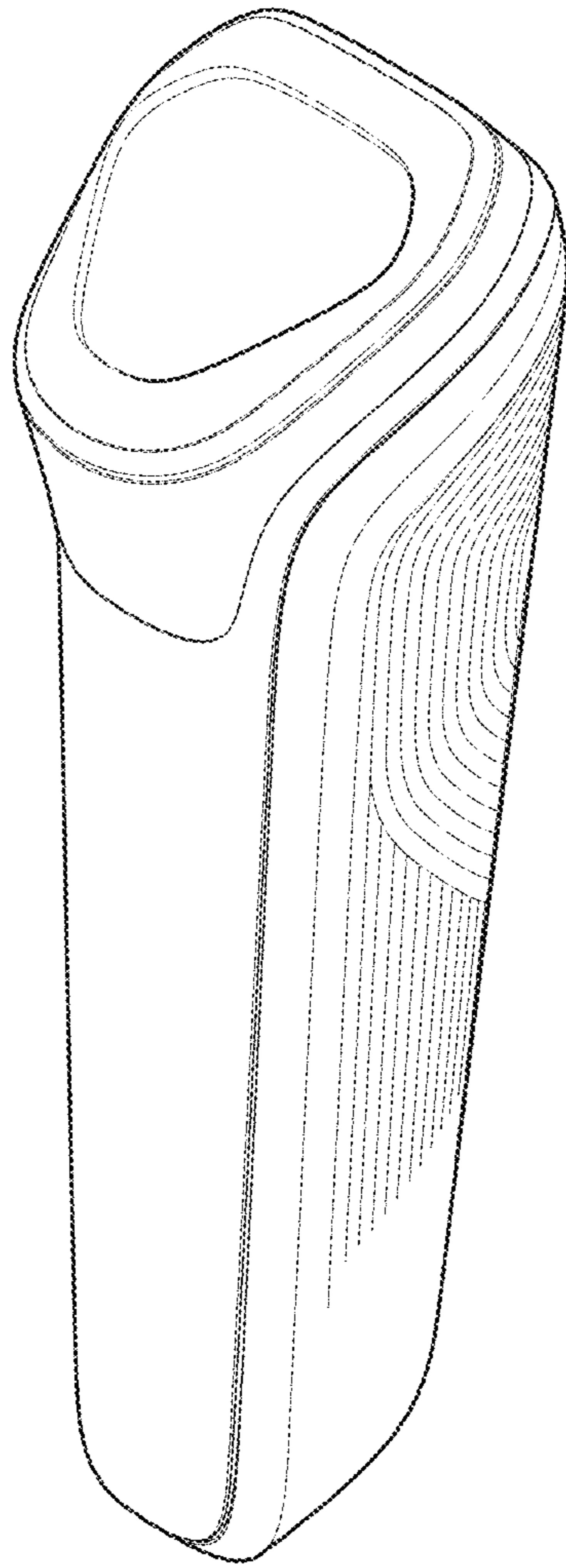

FIG. 8

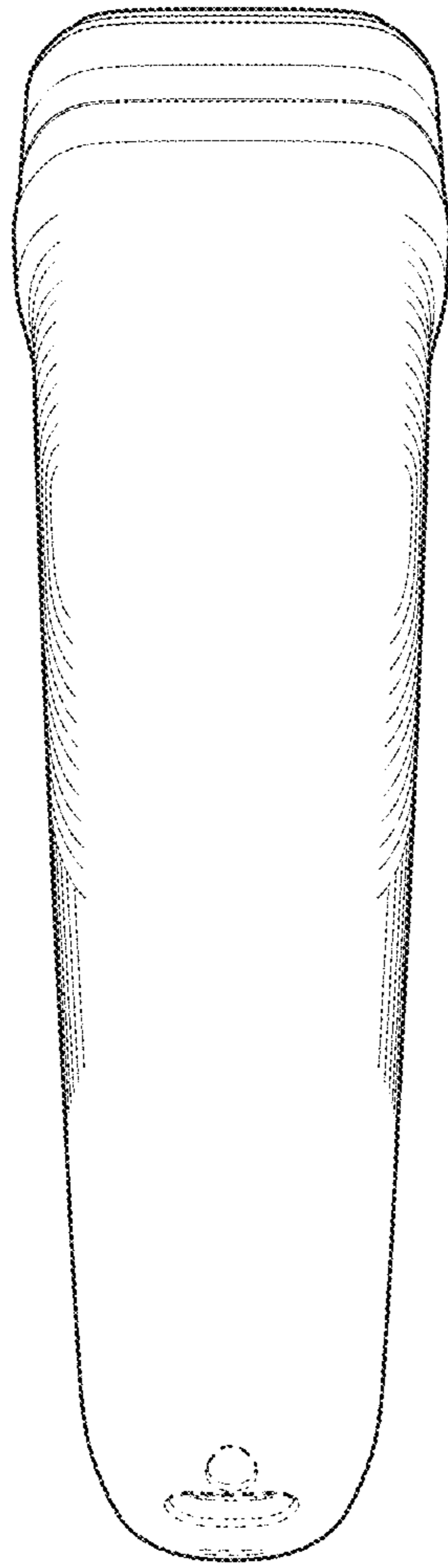

FIG. 9

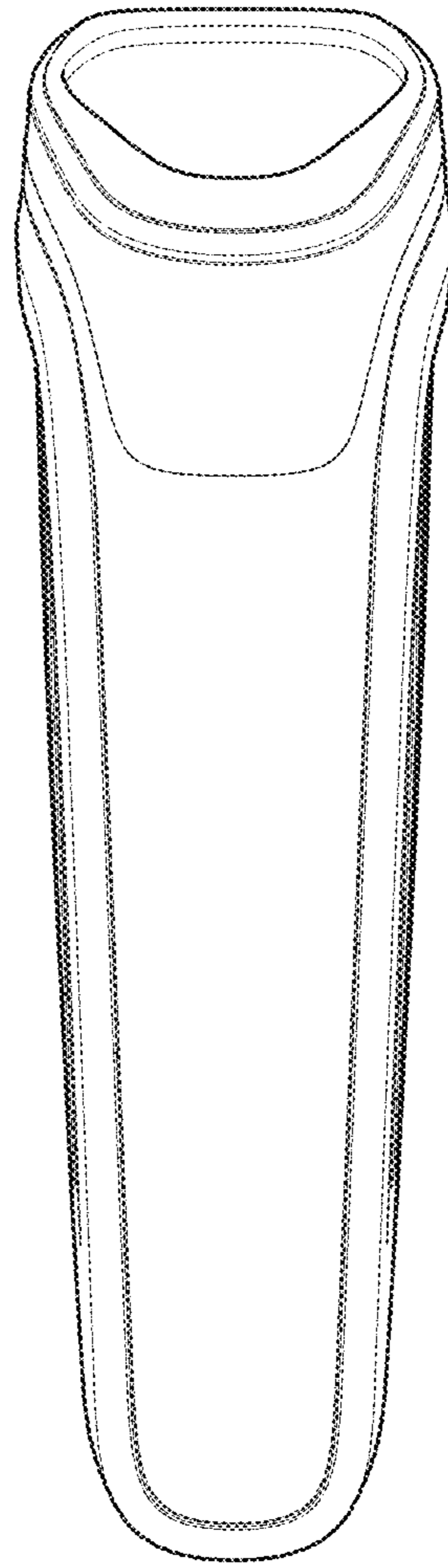

FIG. 10

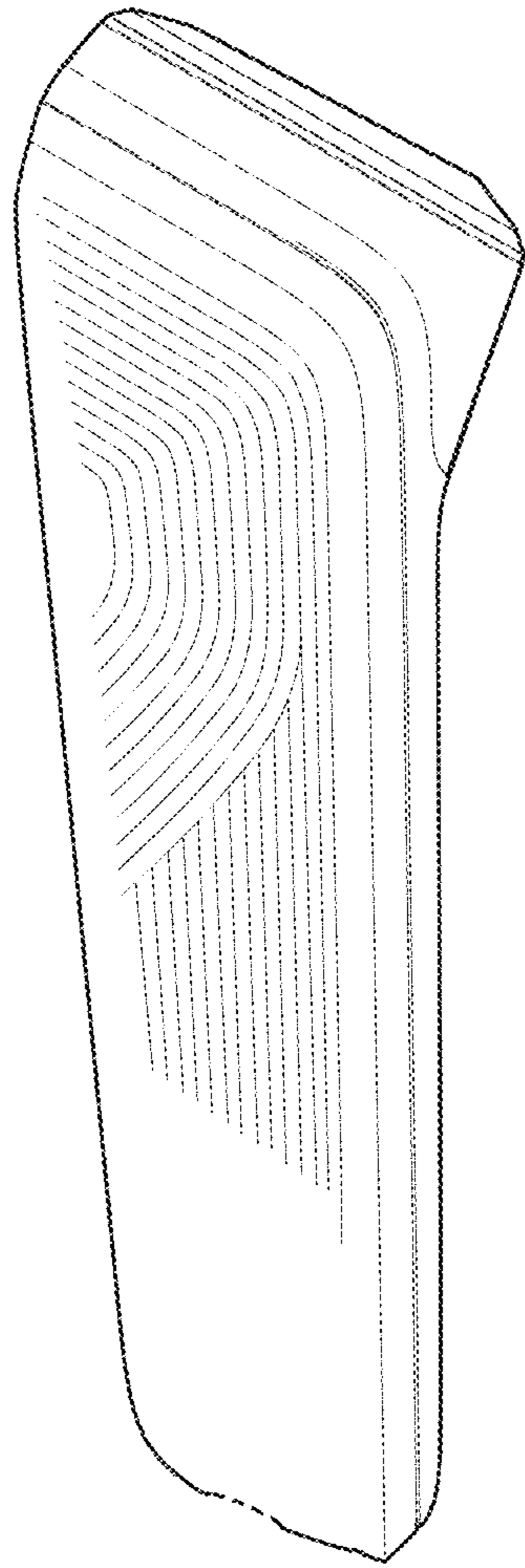

FIG. 11

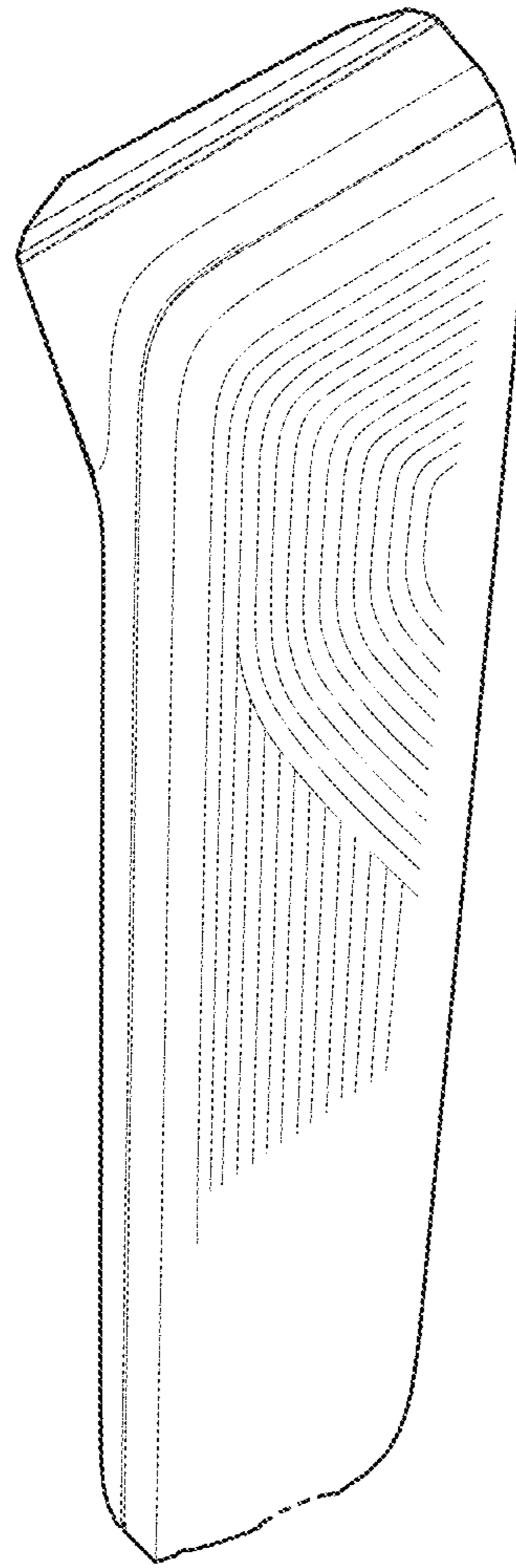

FIG. 12

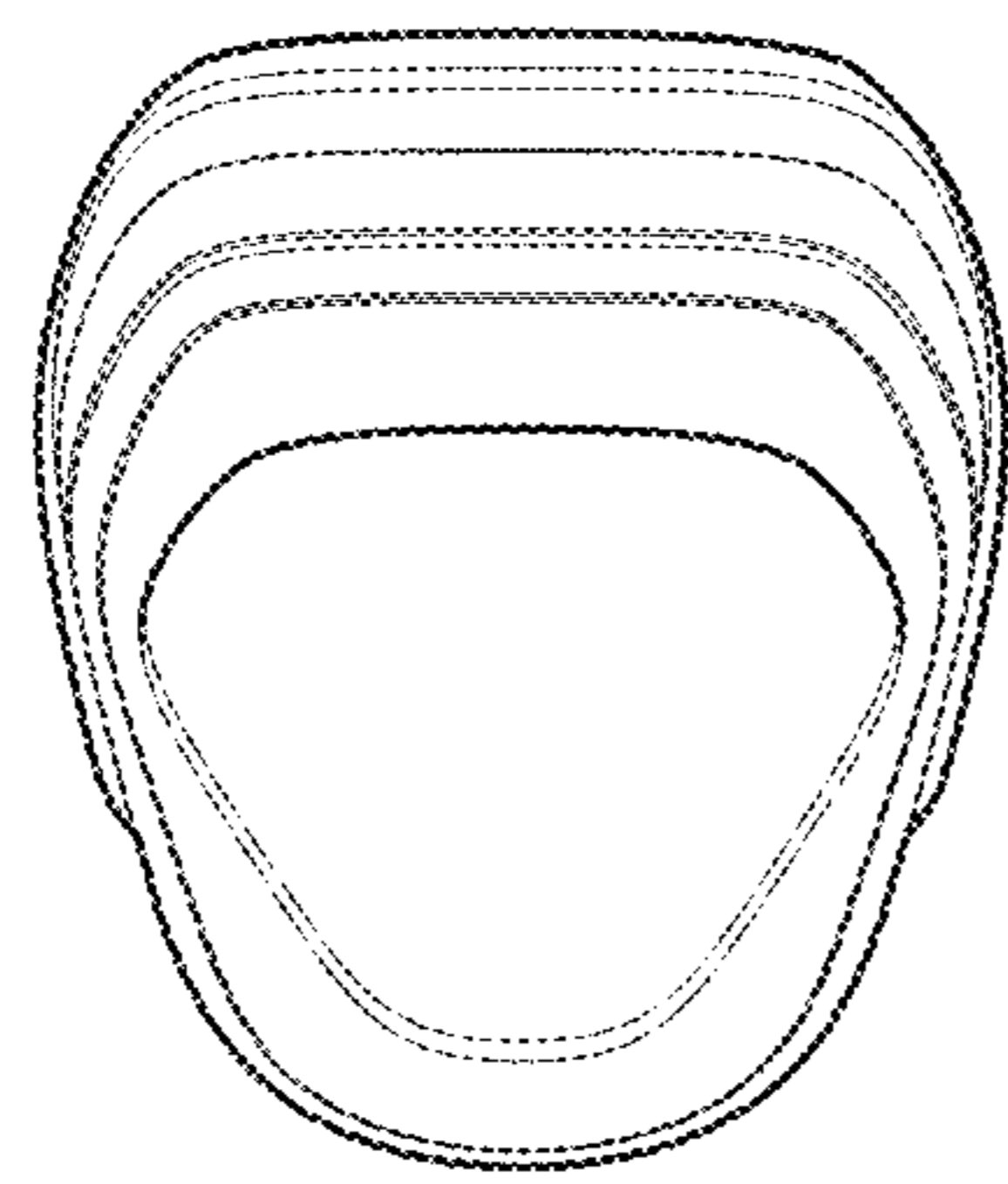

FIG. 13

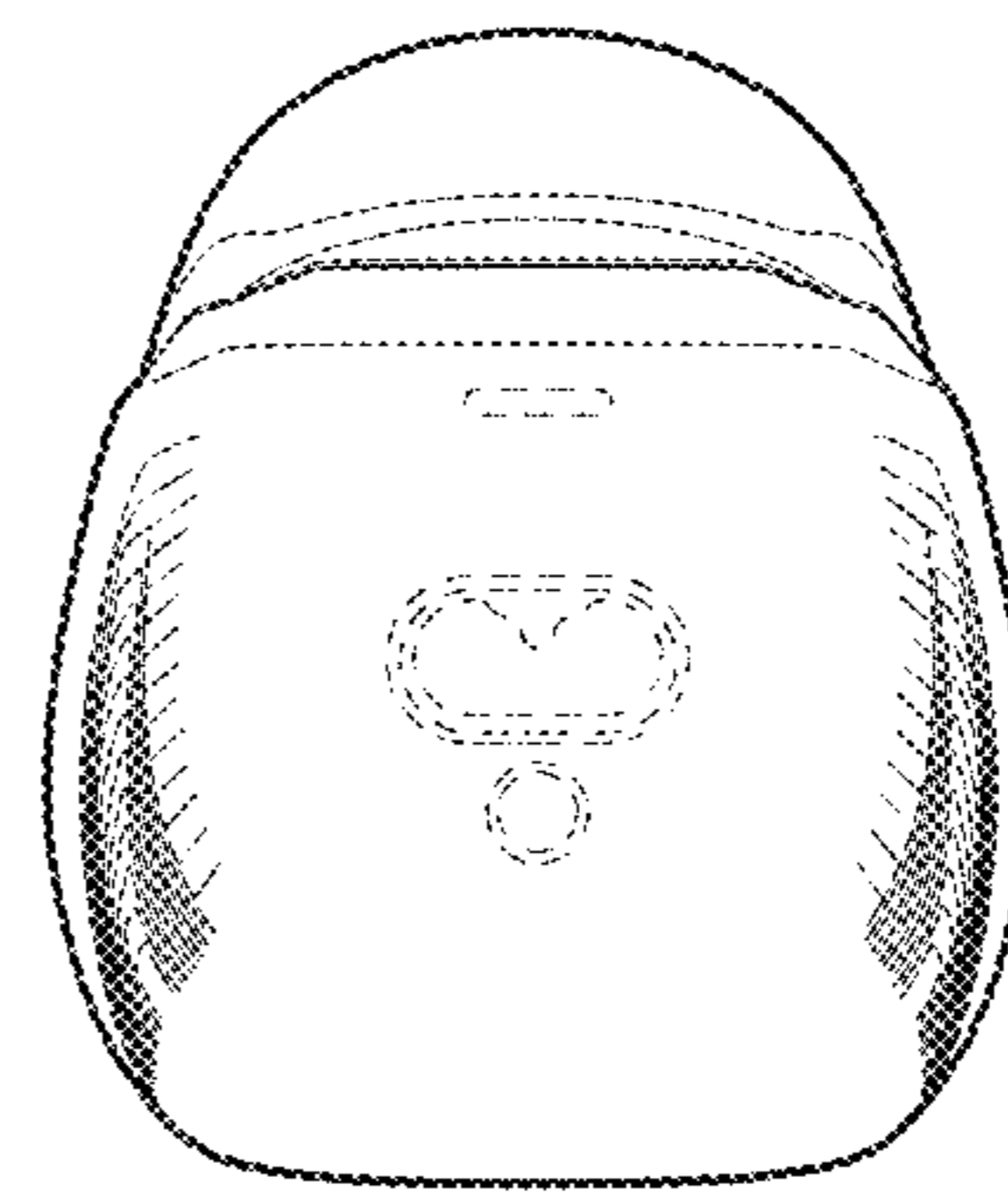

FIG. 14

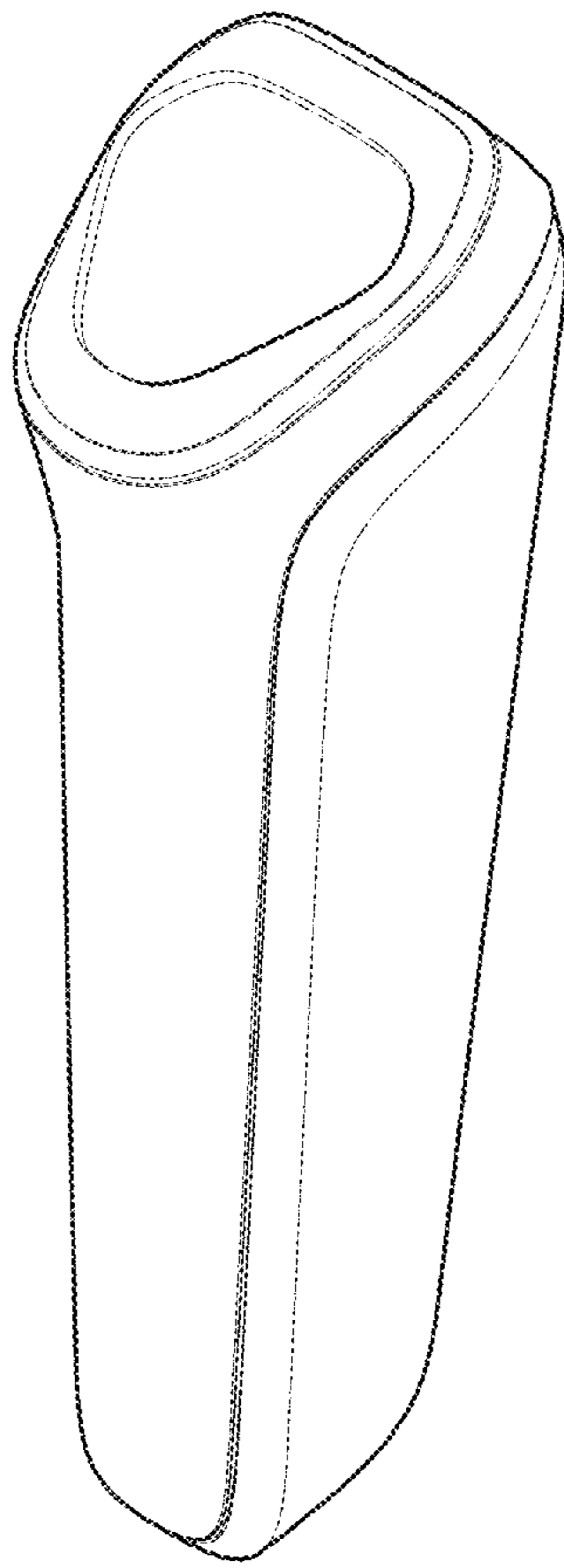

FIG. 15

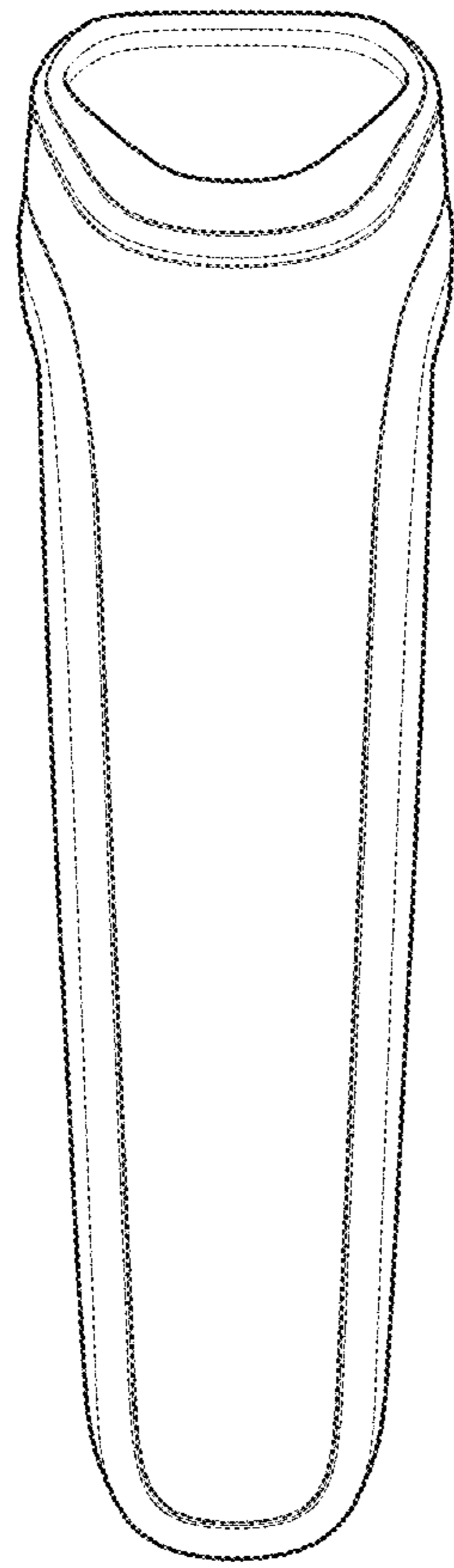

FIG. 16

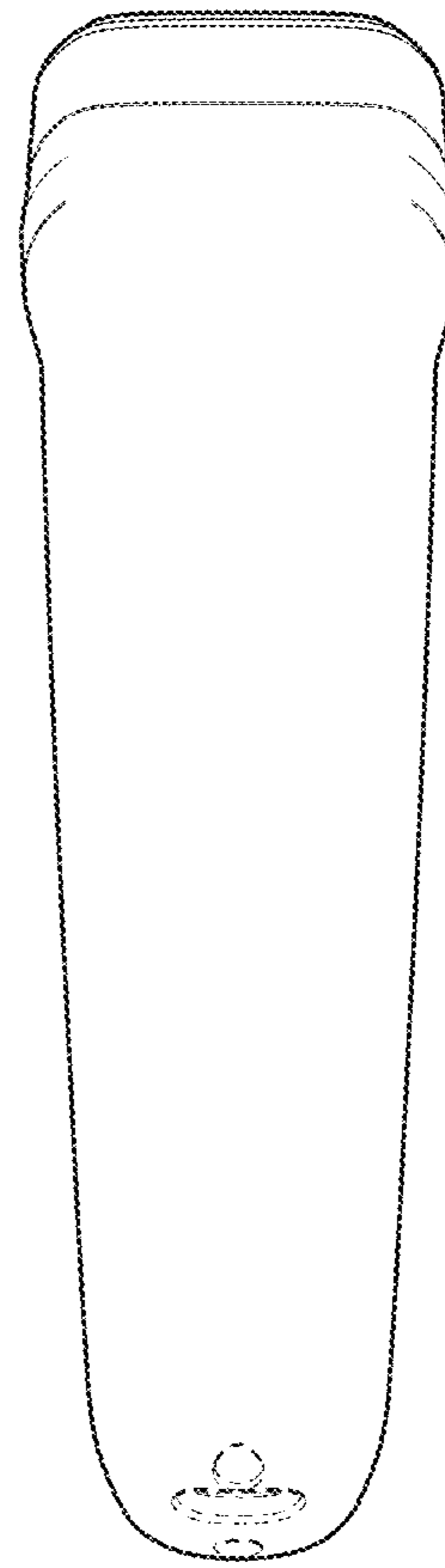

FIG. 17

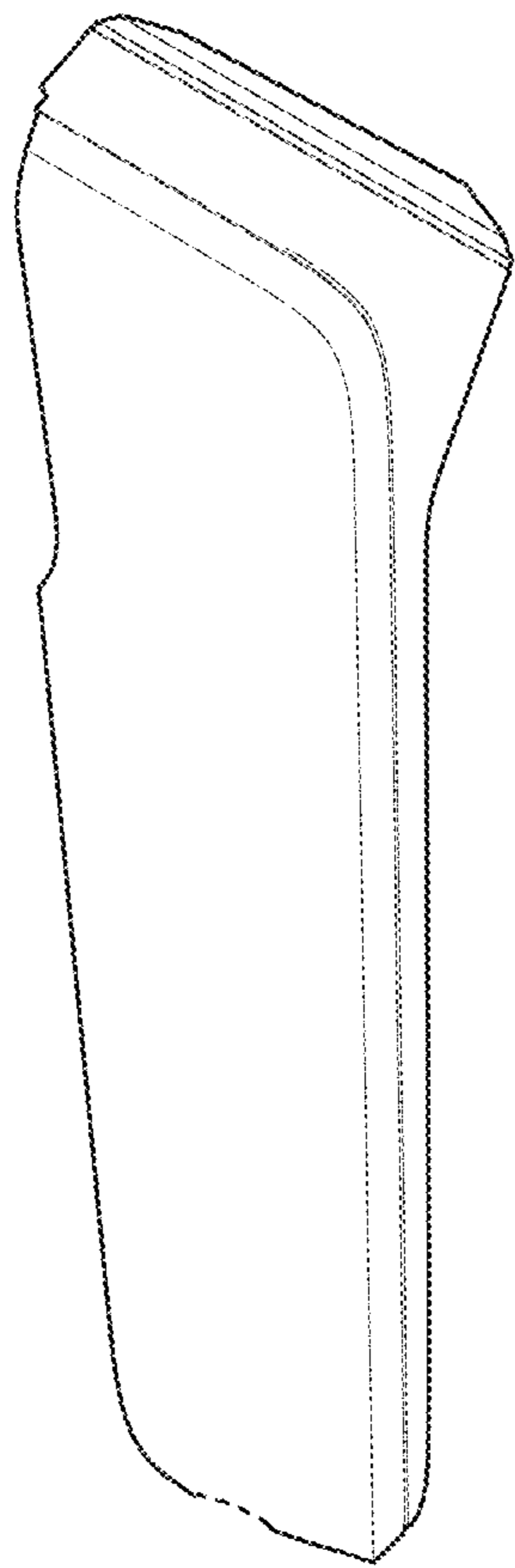

FIG. 18

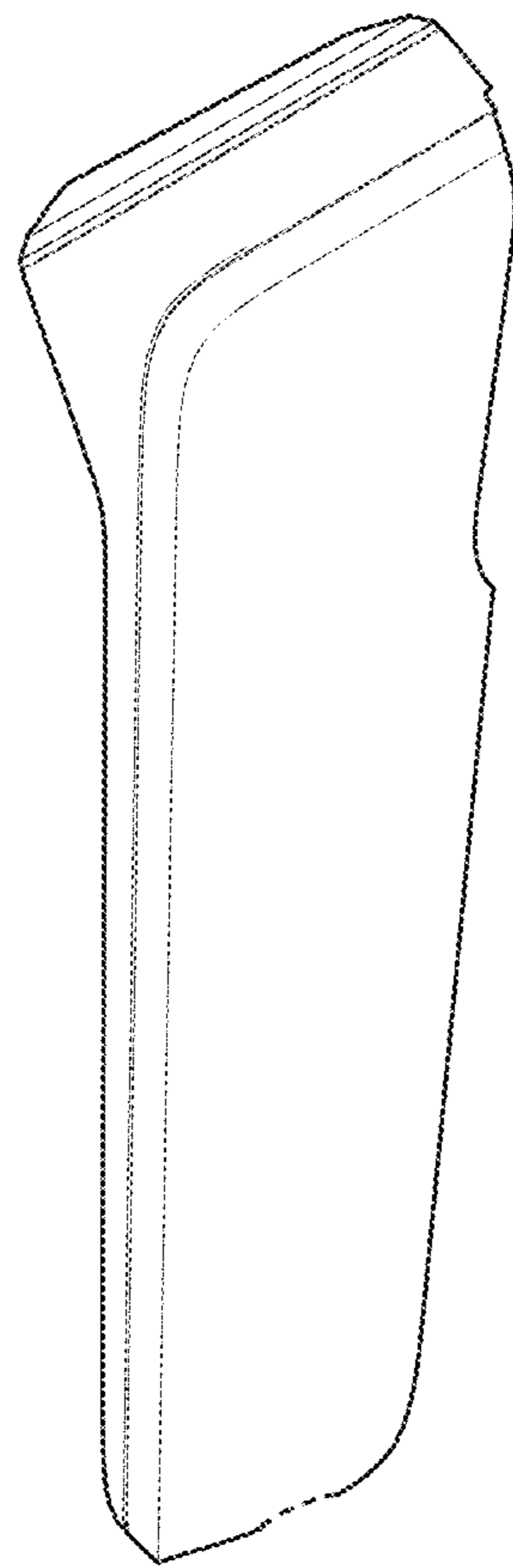

FIG. 19



FIG. 20

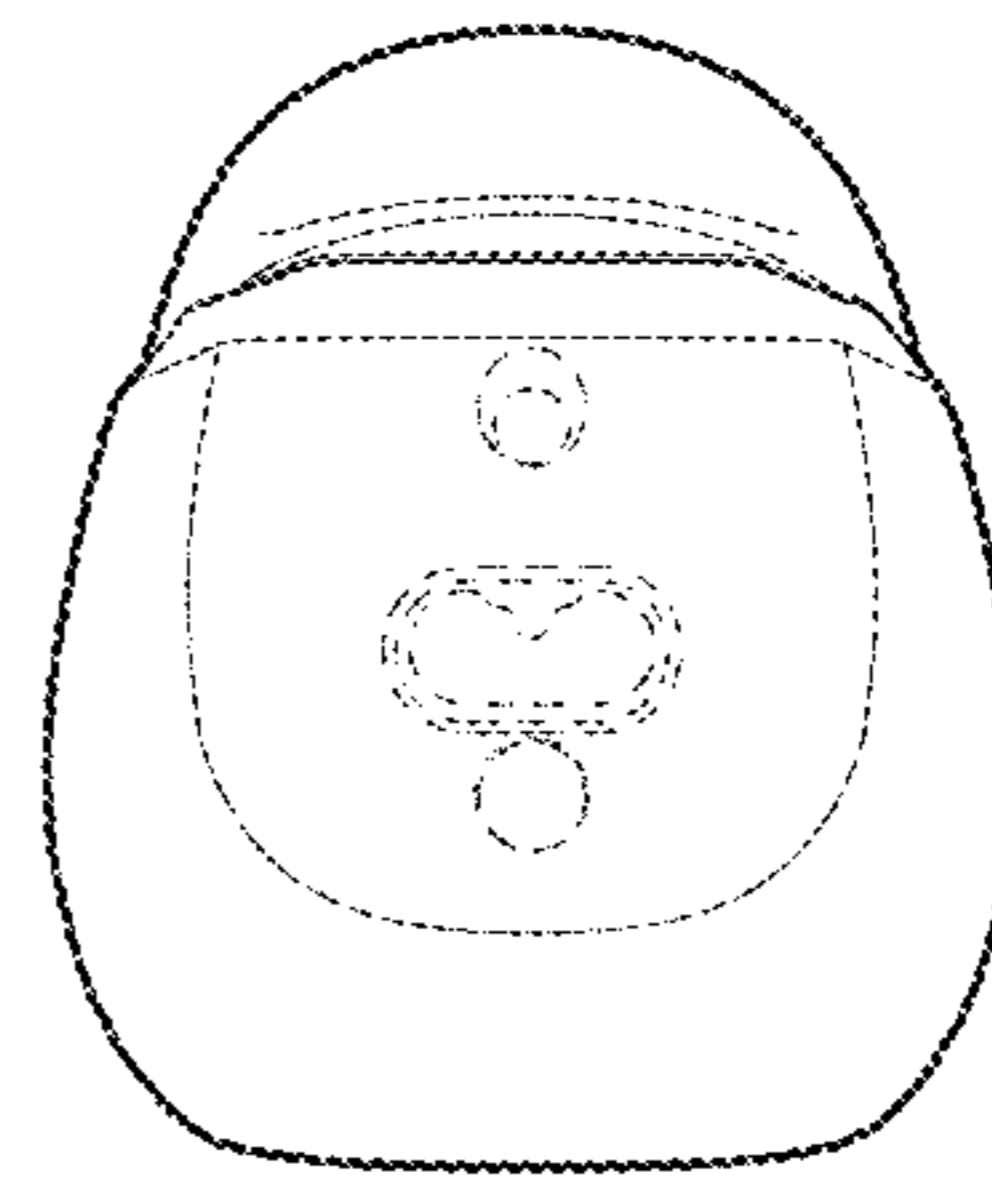

FIG. 21

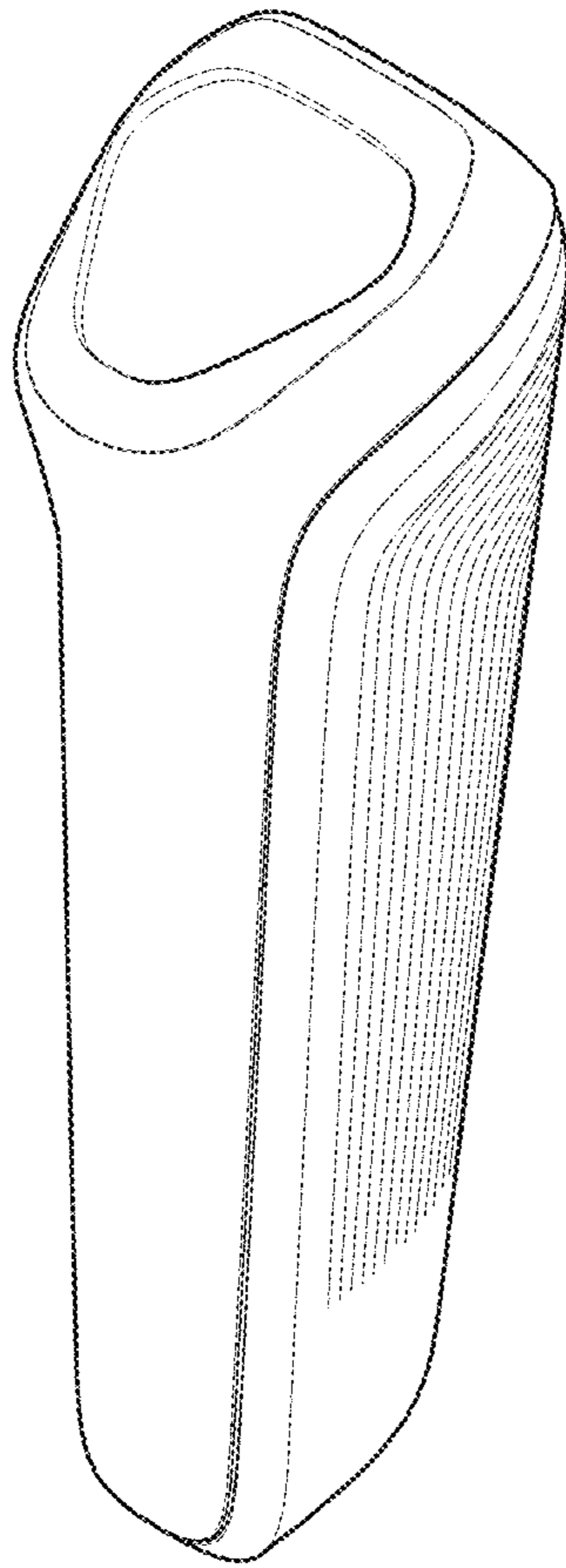

FIG. 22

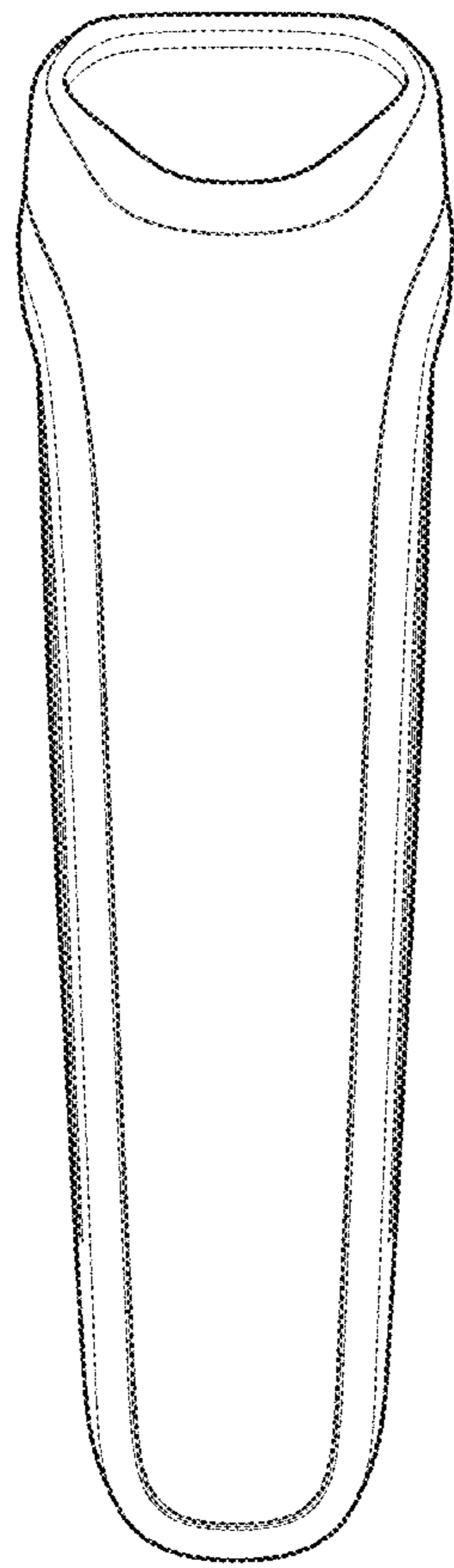

FIG. 23

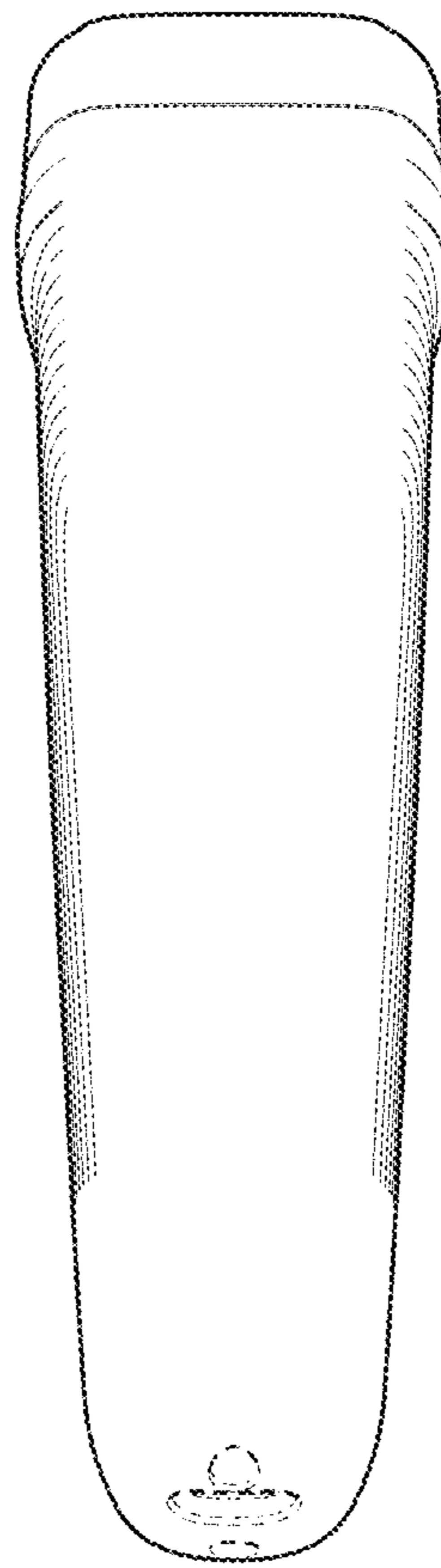

FIG. 24

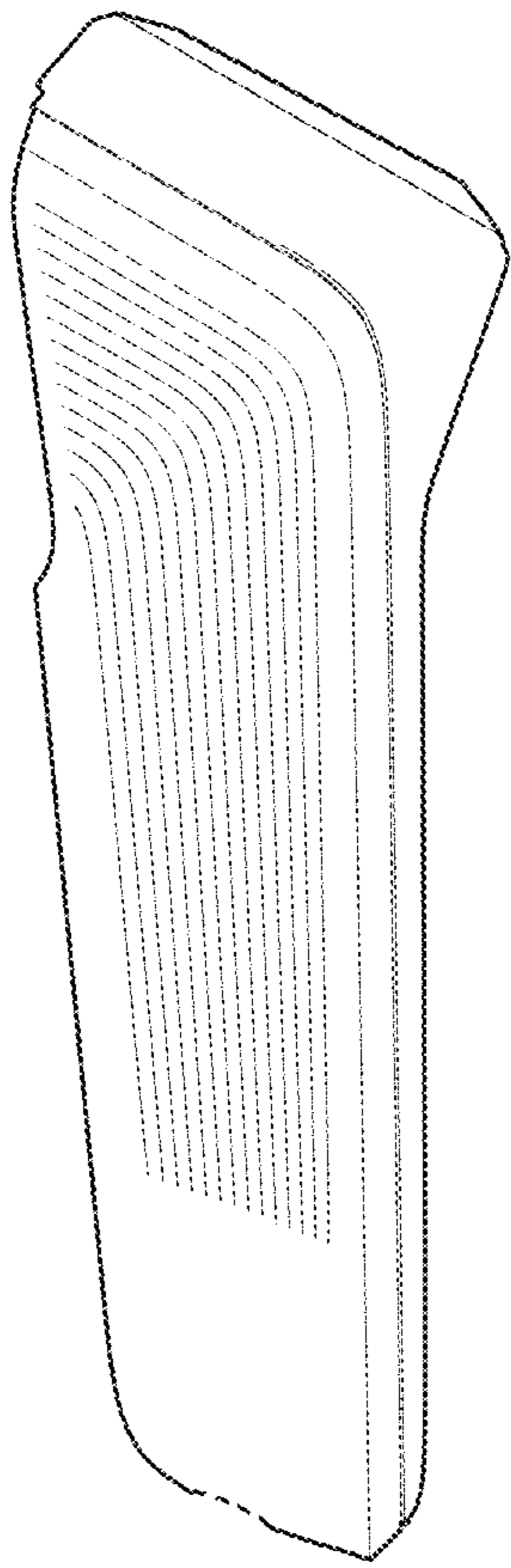

FIG. 25

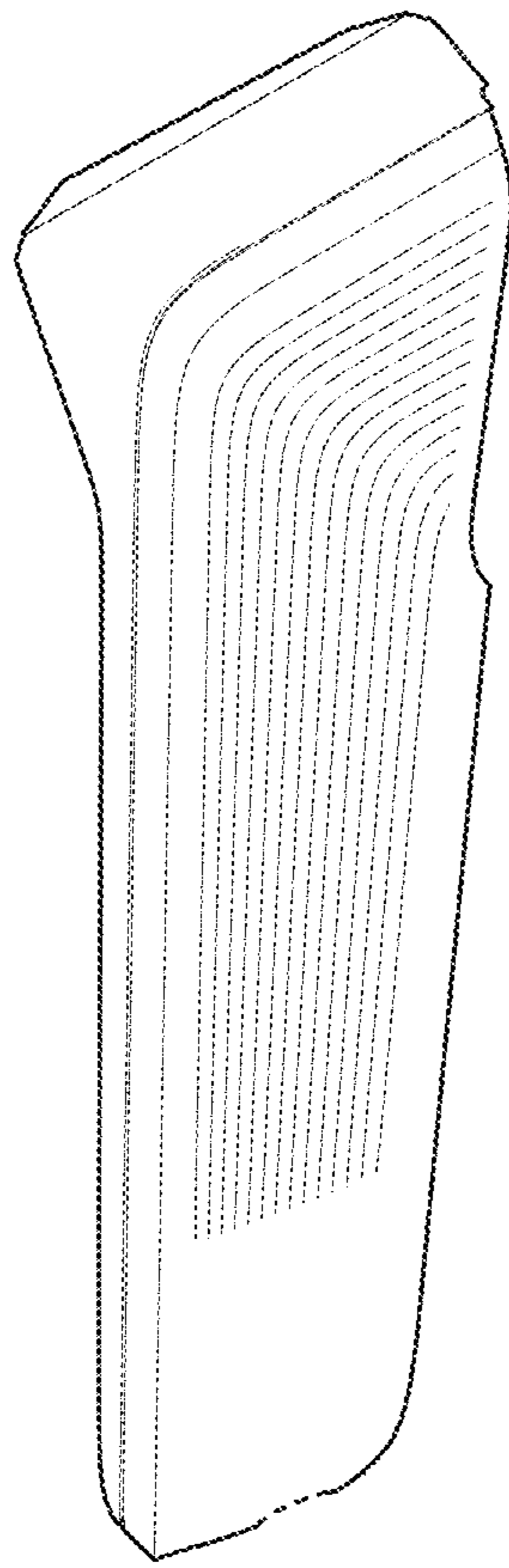

FIG. 26

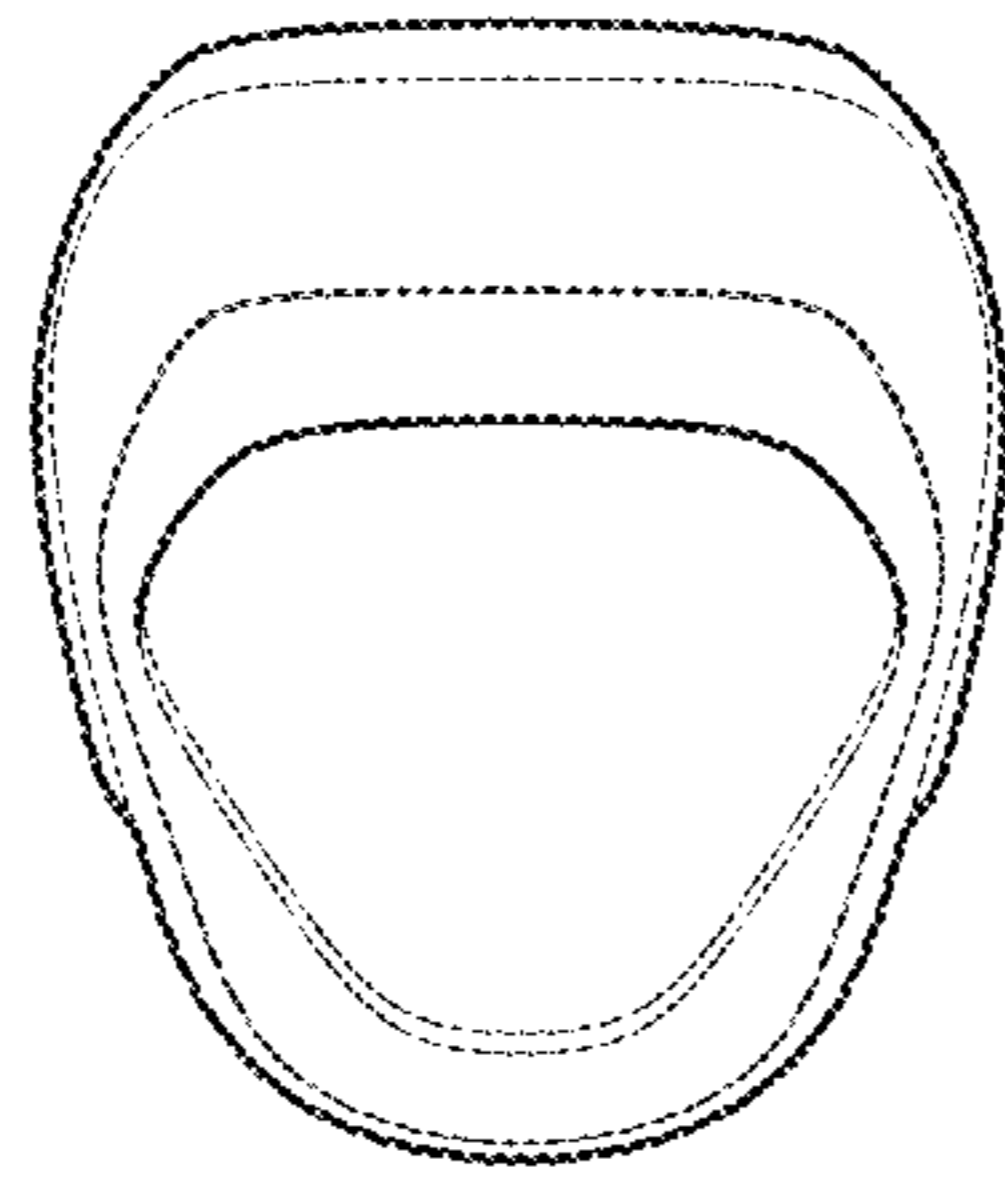

FIG. 27

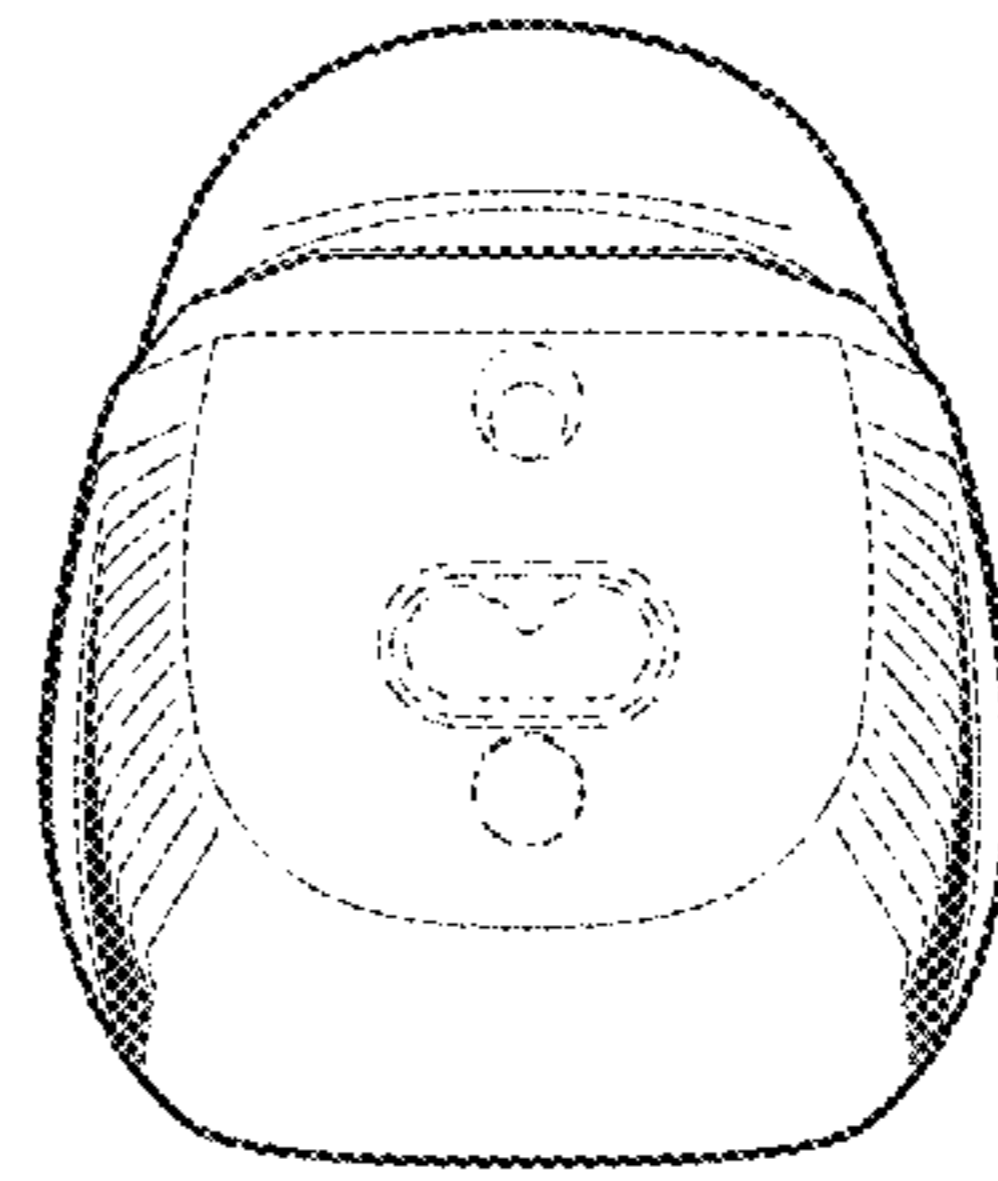

FIG. 28

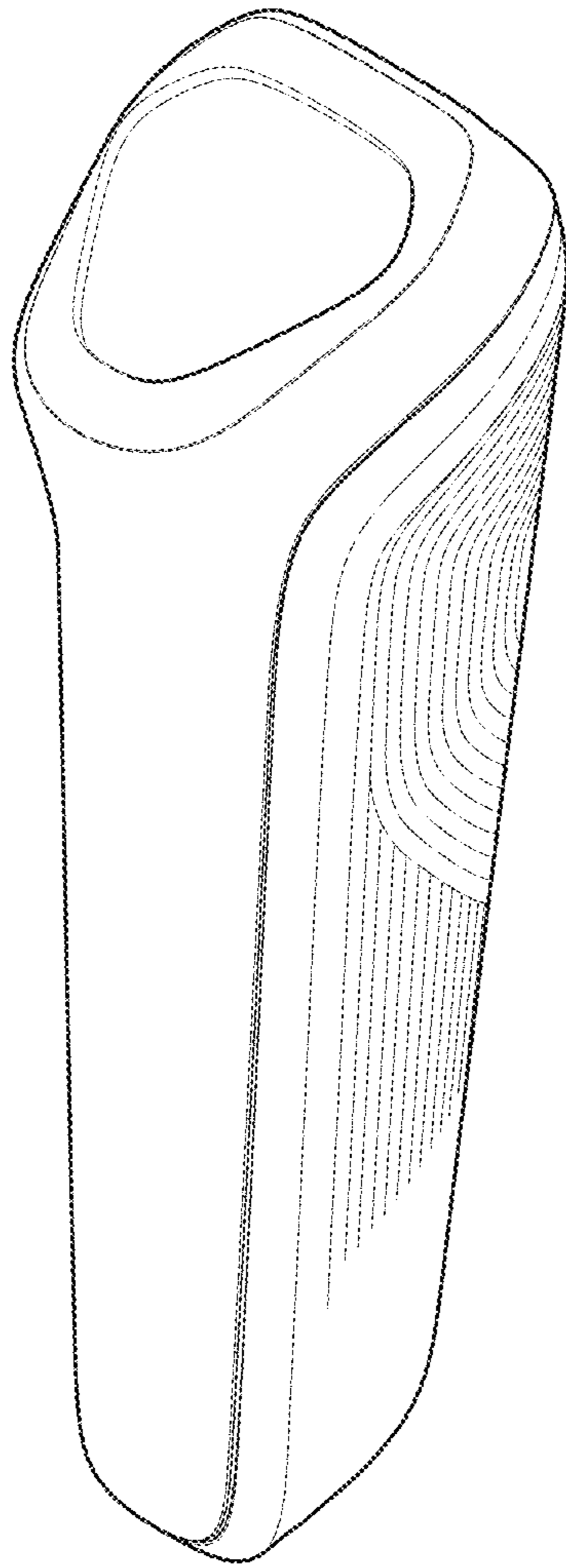

FIG. 29

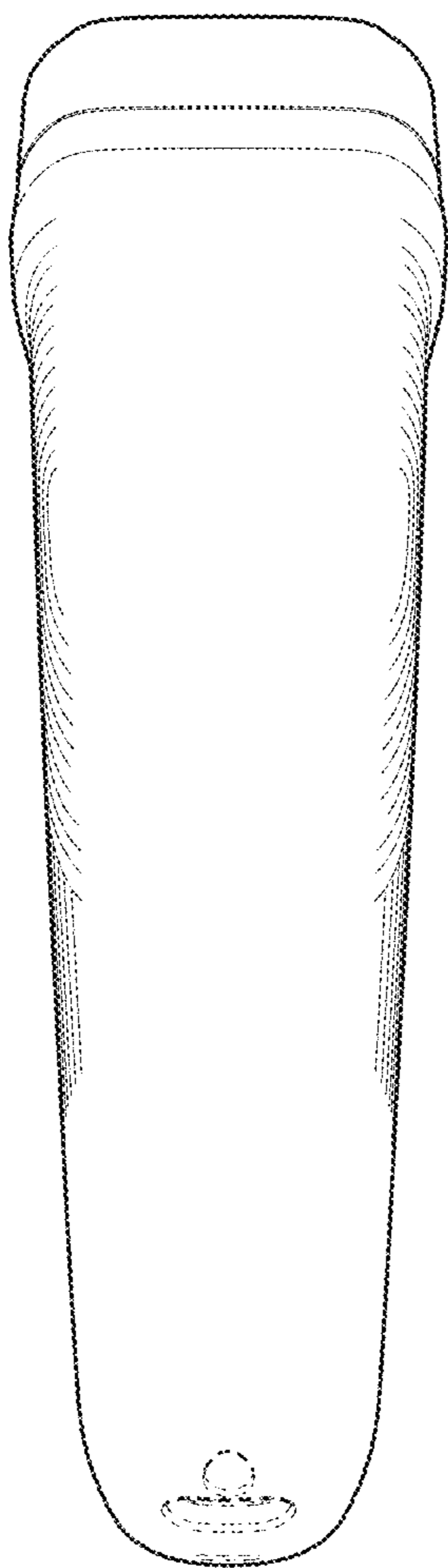

FIG. 30

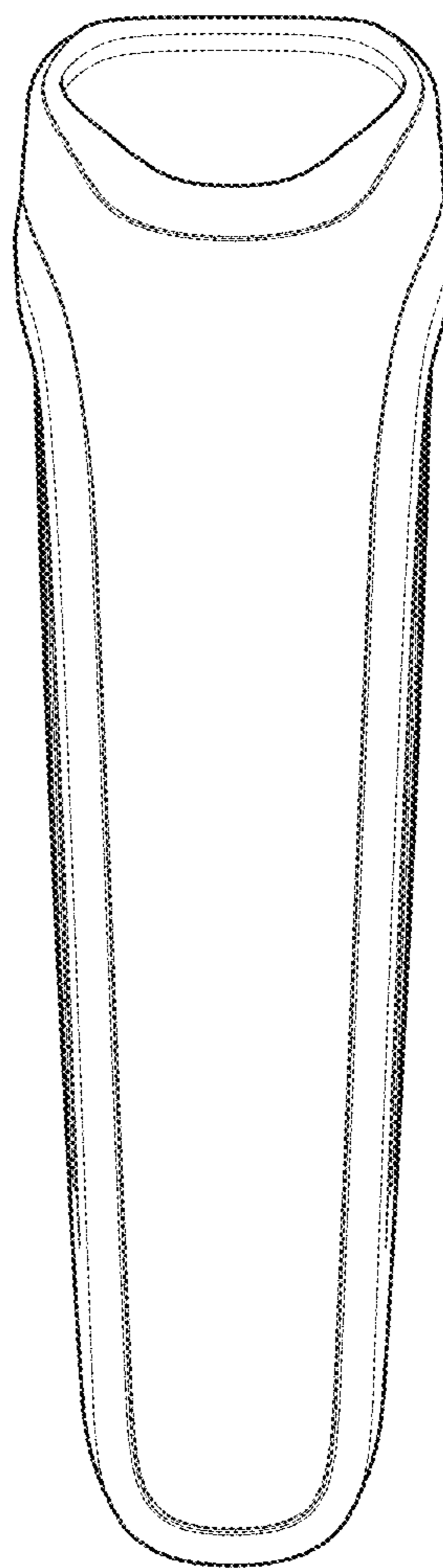

FIG. 31

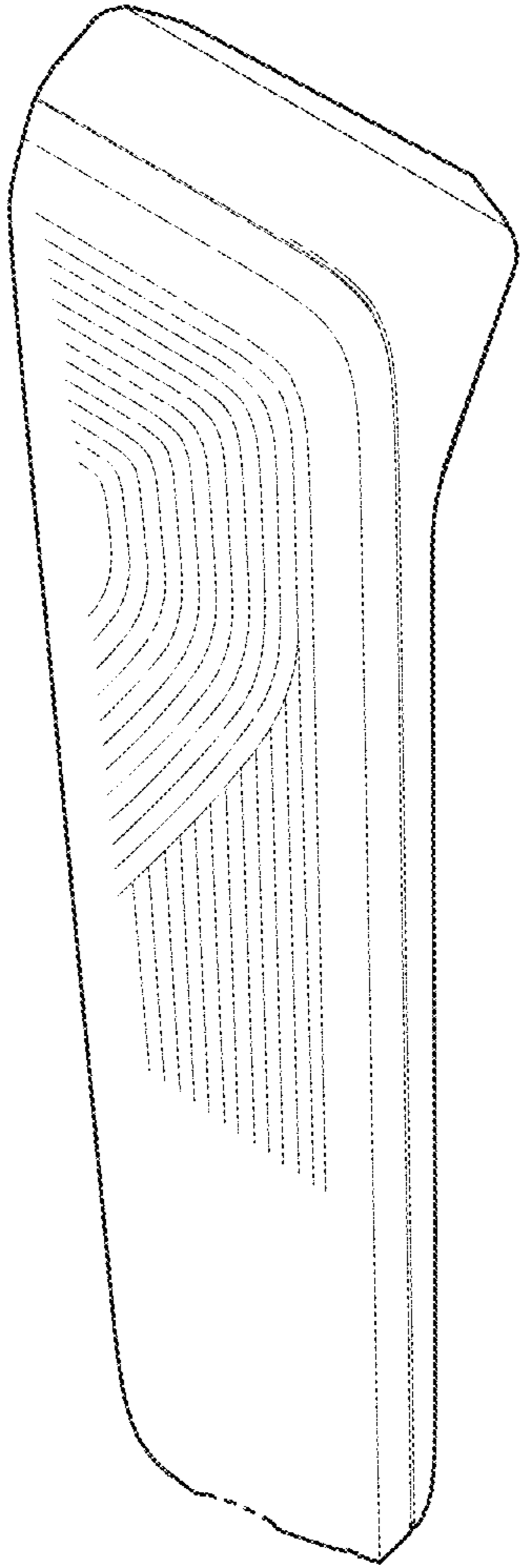

FIG. 32

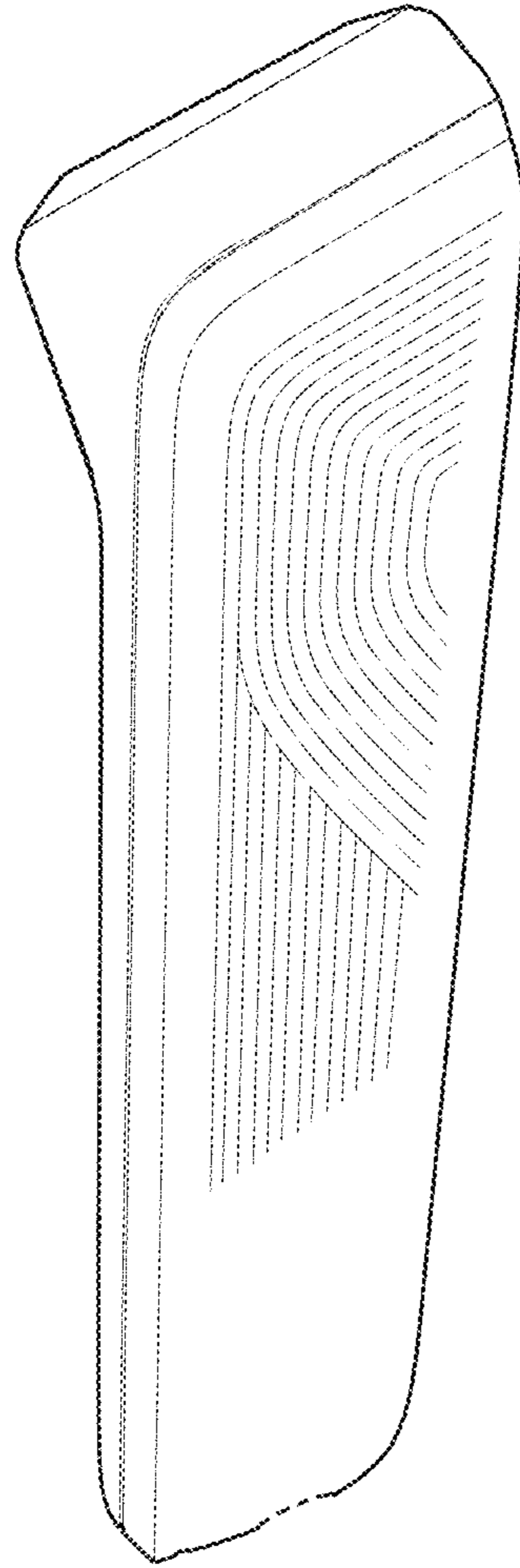

FIG. 33

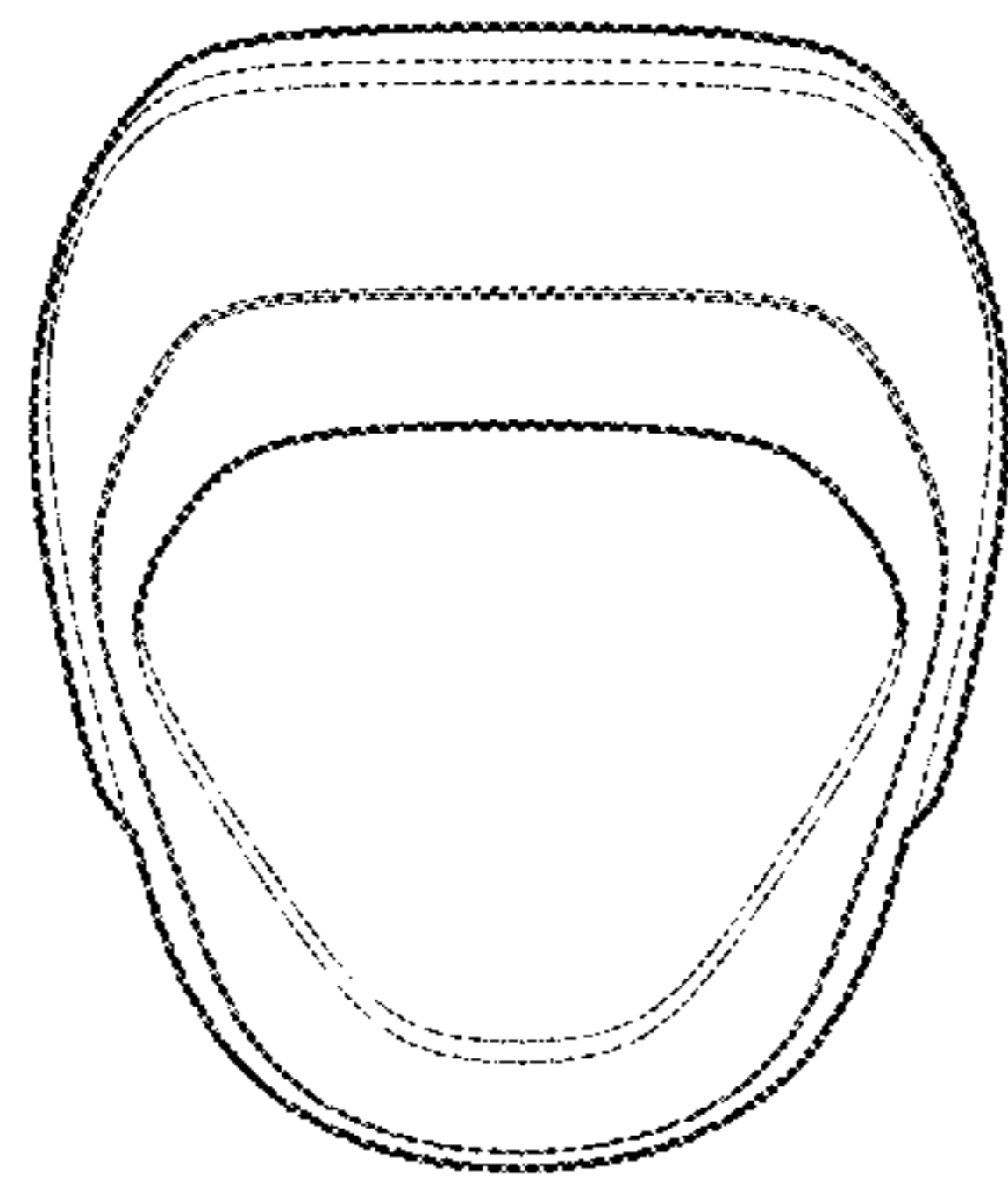

FIG. 34

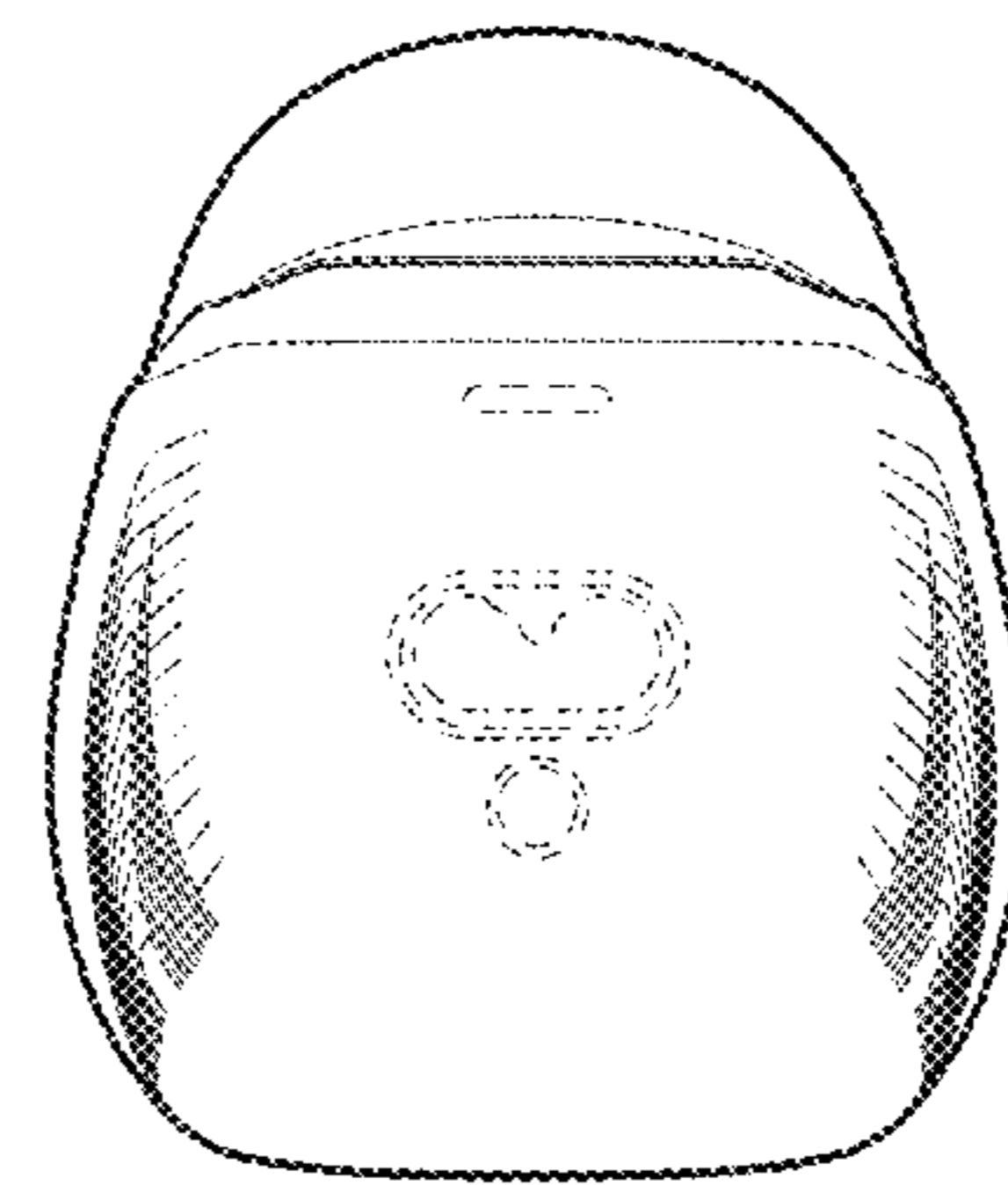

FIG. 35