



US00D949474S

(12) **United States Design Patent**
Zheng et al.

(10) **Patent No.:** **US D949,474 S**
(45) **Date of Patent:** **** Apr. 19, 2022**

(54) **COSMETIC APPLICATOR**

(71) Applicant: **APR Beauty Group Inc.**, Toronto (CA)

(72) Inventors: **Min-Yan Zheng**, Richmond Hill (CA);
Feng-ying Fu, Markham (CA); **Jun Shen**, New Westminster (CA)

(73) Assignee: **APR BEAUTY GROUP INC.**, Toronto (CA)

(**) Term: **15 Years**

(21) Appl. No.: **29/751,610**

(22) Filed: **Sep. 22, 2020**

(51) **LOC (13) Cl.** **28-03**

(52) **U.S. Cl.**
USPC **D28/7**

(58) **Field of Classification Search**
USPC D28/7, 8, 76, 85, 99
CPC A45D 33/12; A45D 40/24; A45D 40/26;
A45D 40/261
See application file for complete search history.

(56) **References Cited**

U.S. PATENT DOCUMENTS

D638,987 S *	5/2011	Limongi	D28/7
D638,989 S *	5/2011	Limongi	D28/7
D640,000 S *	6/2011	Limongi	D28/7
D641,932 S *	7/2011	Poletto	D28/76
D732,734 S *	6/2015	Poletto	D28/7
D806,314 S *	12/2017	Hamida	D28/7
D807,580 S *	1/2018	Nagata	D28/7
D919,883 S *	5/2021	Shen	D28/7
D927,063 S *	8/2021	Roh	D28/7

* cited by examiner

Primary Examiner — Zenia I Bennett

(57) **CLAIM**

The ornamental design for a cosmetic applicator, as shown and described.

DESCRIPTION

FIG. 1 is a front perspective view of a first embodiment of the cosmetic applicator embodying the new design;
 FIG. 2 is a rear perspective view of the cosmetic applicator thereof;
 FIG. 3 is a front elevation view of the cosmetic applicator thereof;
 FIG. 4 is a rear elevation view of the cosmetic applicator thereof;
 FIG. 5 is a right side view of the cosmetic applicator thereof; a left side view of the cosmetic applicator being same as the right side view;
 FIG. 6 is a top plan view of the cosmetic applicator thereof;
 FIG. 7 is a bottom plan view of the cosmetic applicator thereof;
 FIG. 8 is a front perspective view of a second embodiment of the cosmetic applicator embodying the new design;
 FIG. 9 is a rear perspective view of the cosmetic applicator thereof;
 FIG. 10 is front elevation view of the cosmetic applicator thereof;
 FIG. 11 is a rear elevation view of the cosmetic applicator thereof;
 FIG. 12 is a right side view of the cosmetic applicator thereof; a left side view of the cosmetic applicator being same as the right side view;
 FIG. 13 is a top plan view of the cosmetic applicator thereof; and,
 FIG. 14 is a bottom plan view of the cosmetic applicator thereof.
 The broken lines in the drawing are for illustrative purposes only and form no part of the claimed design.

1 Claim, 12 Drawing Sheets

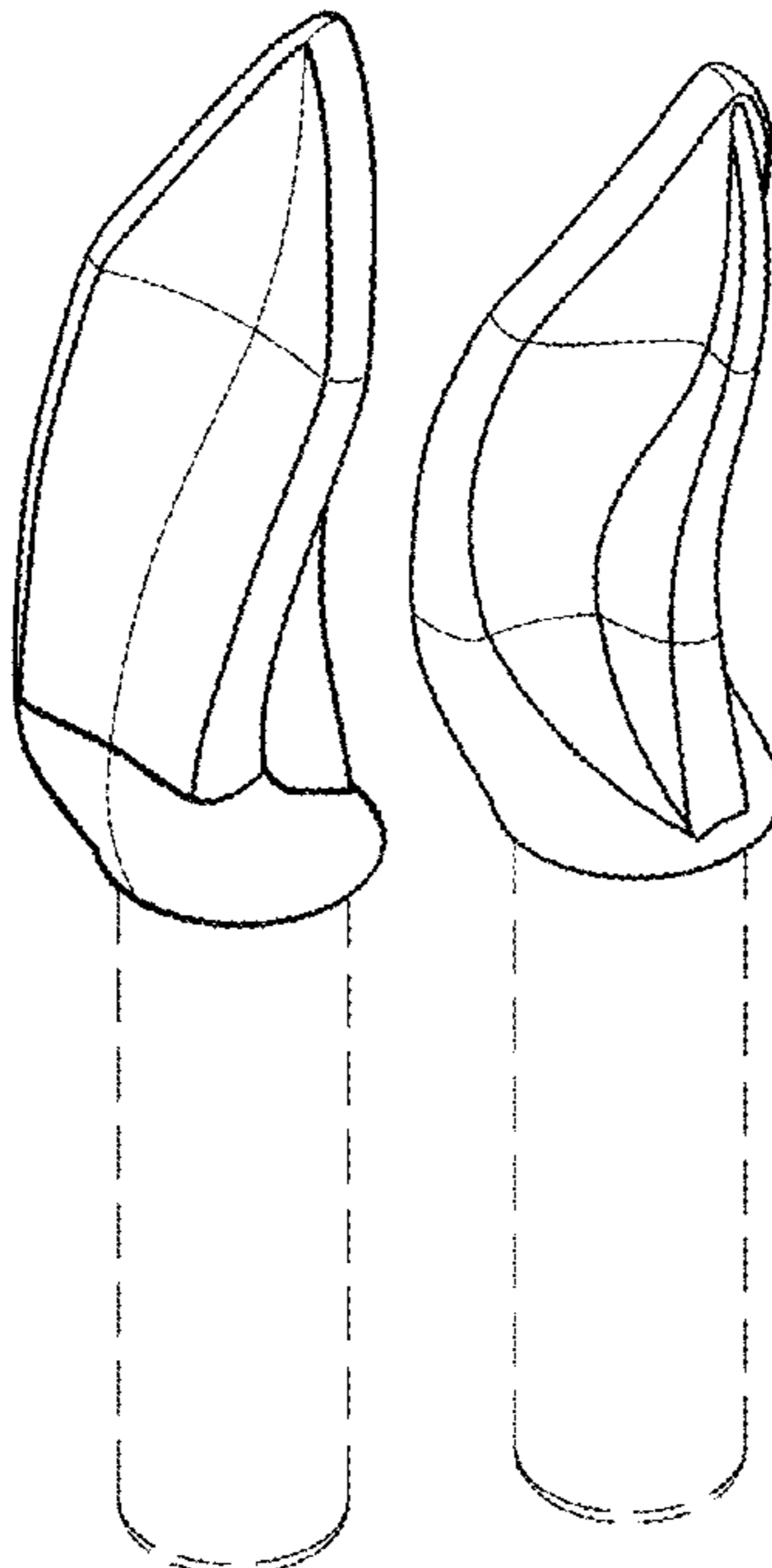

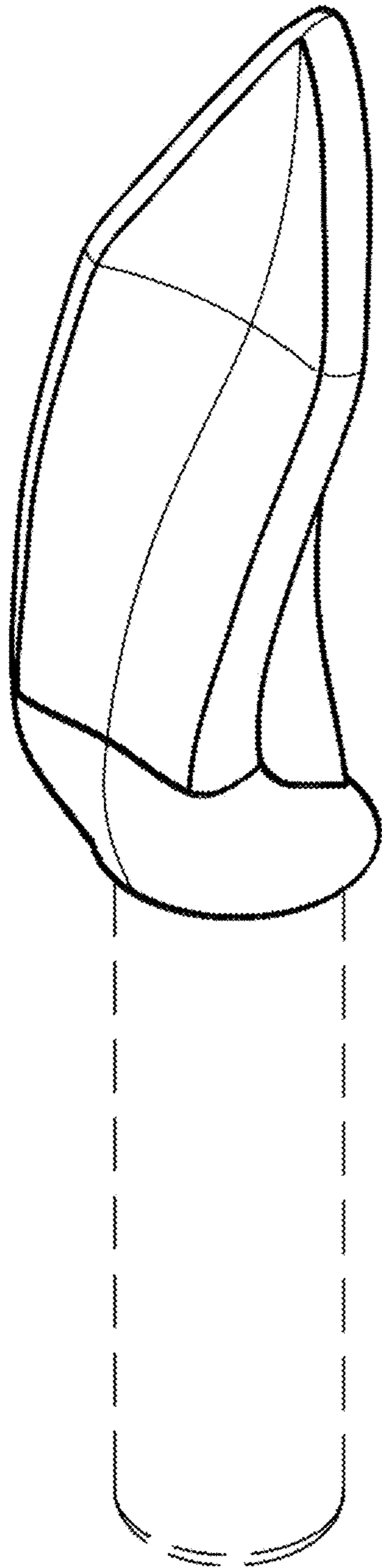

FIG. 1

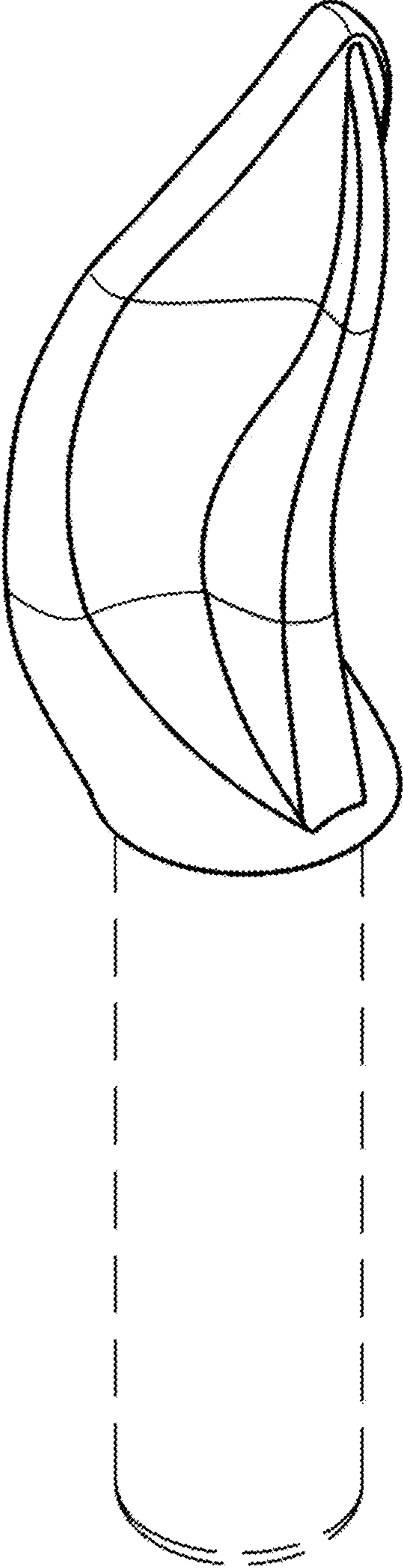

FIG. 2

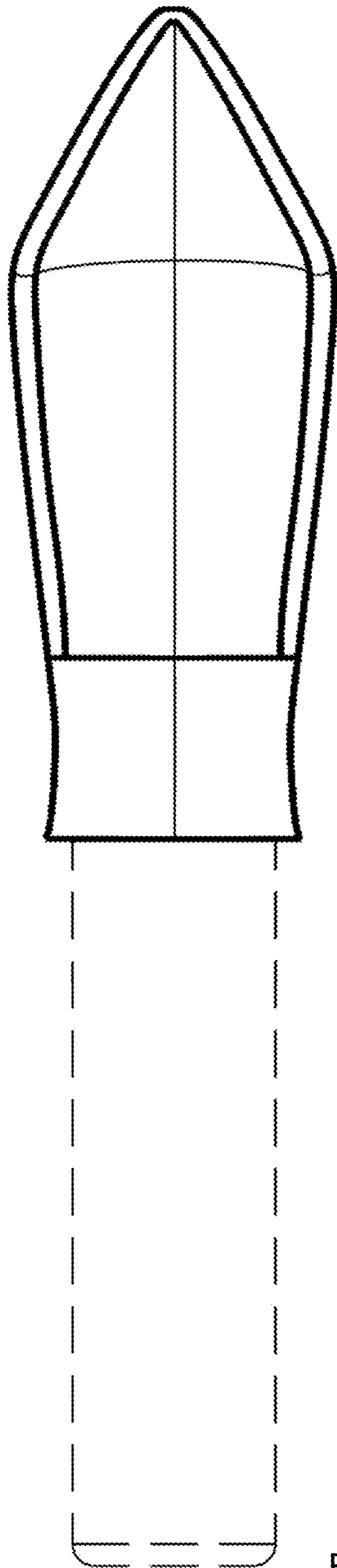

FIG. 3

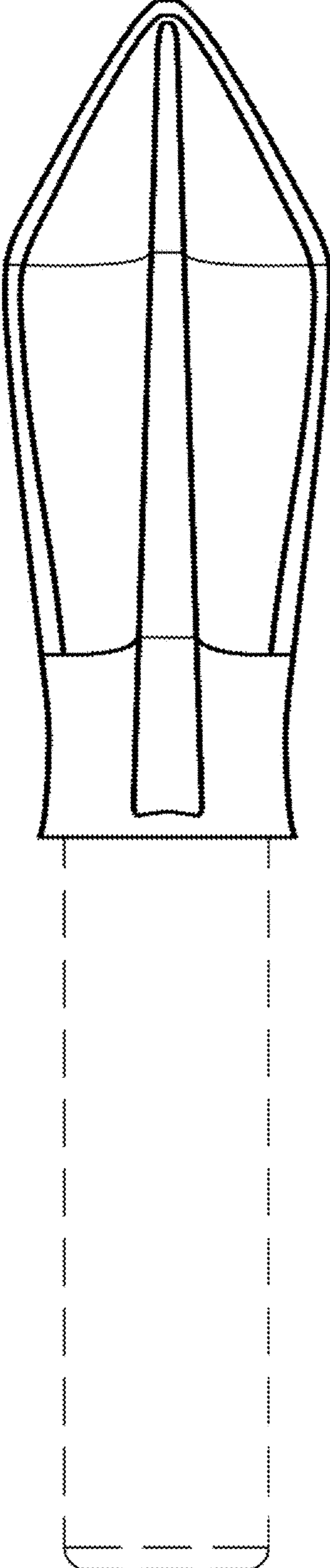

FIG. 4

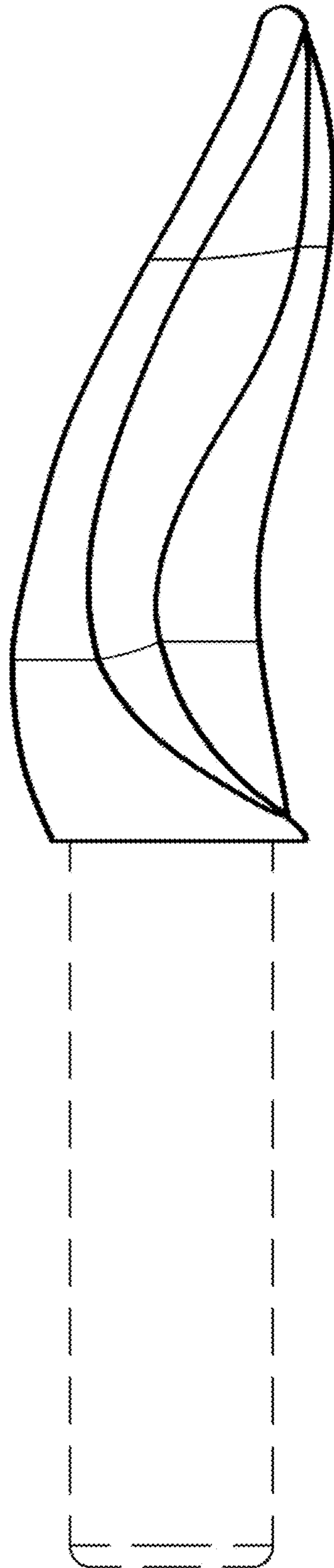

FIG. 5

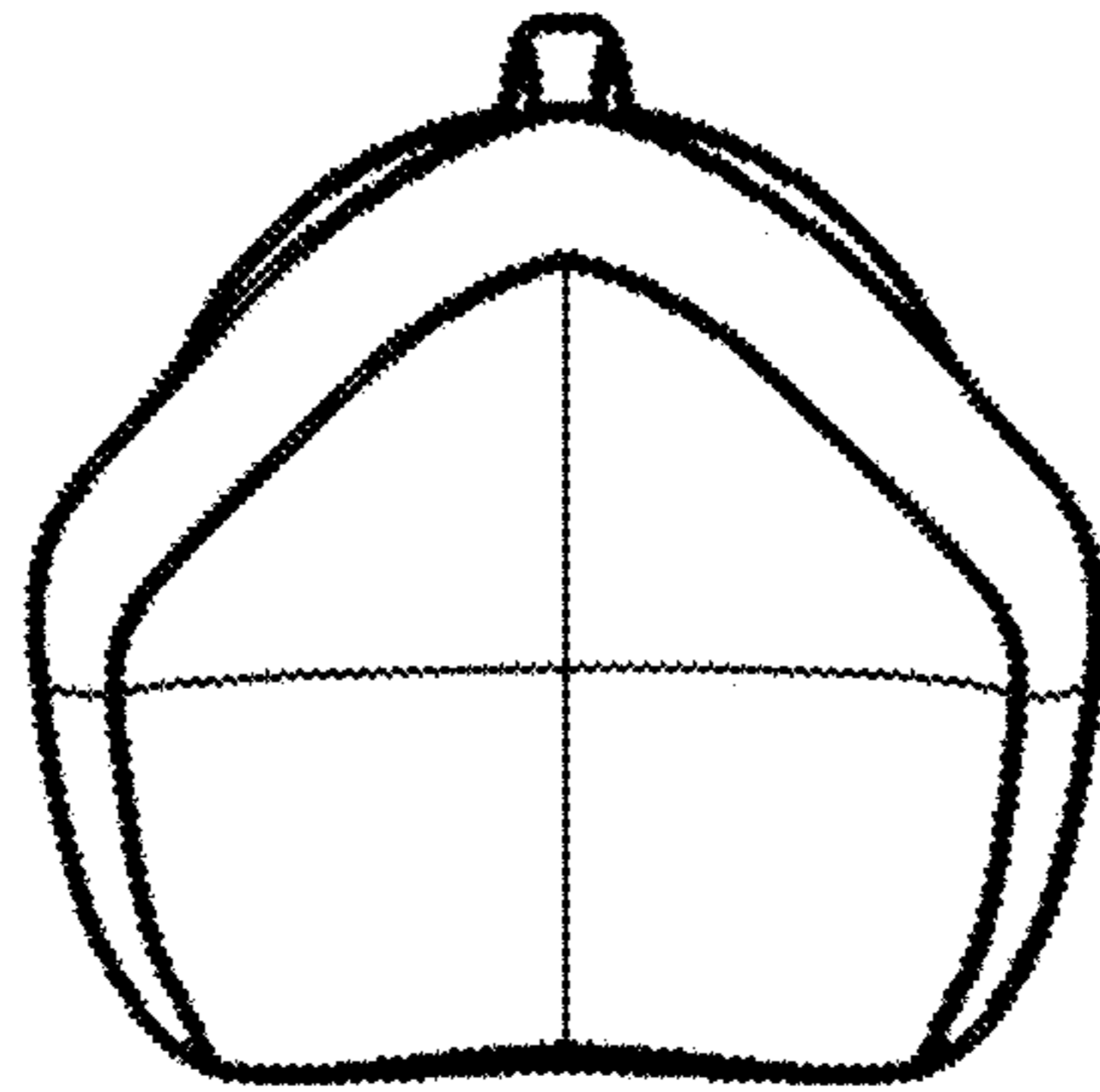

FIG. 6

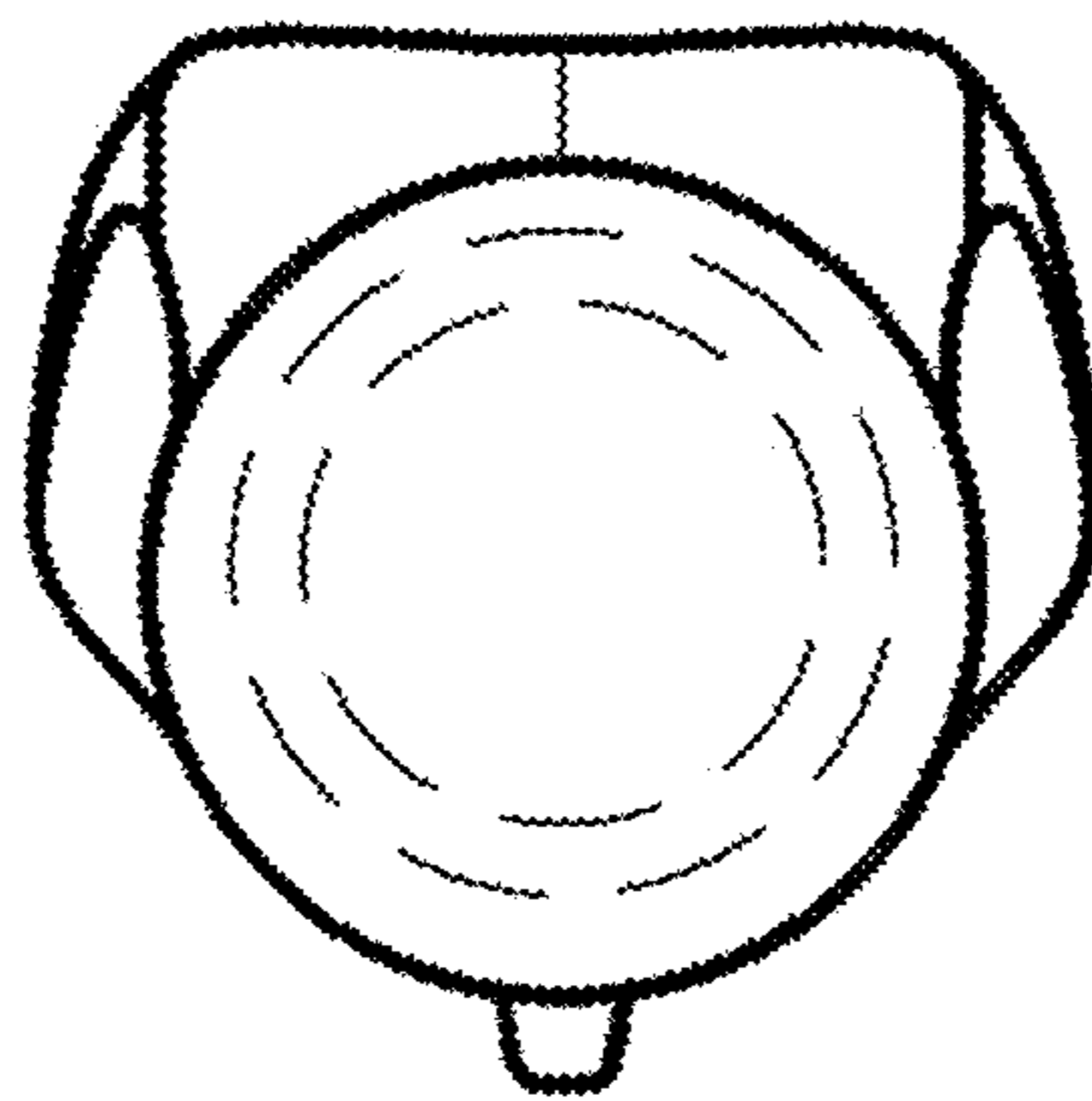

FIG. 7

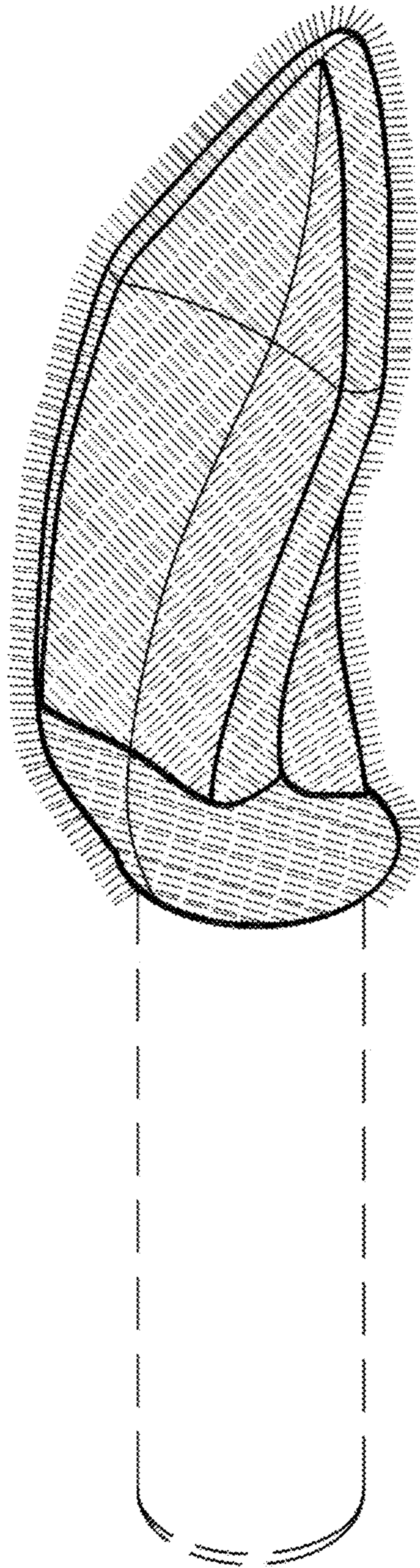

FIG. 8

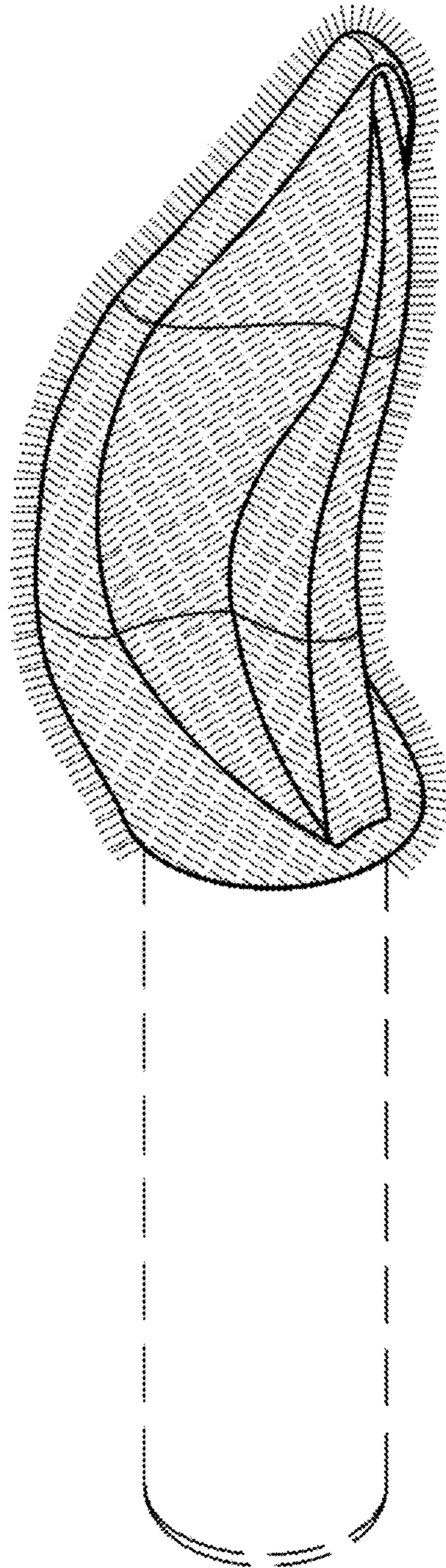

FIG. 9

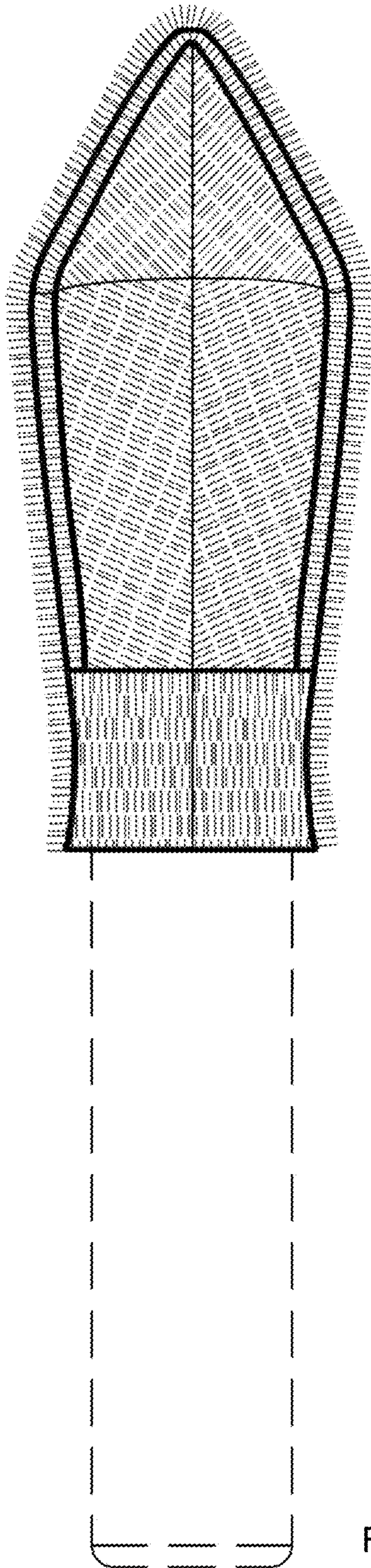

FIG. 10

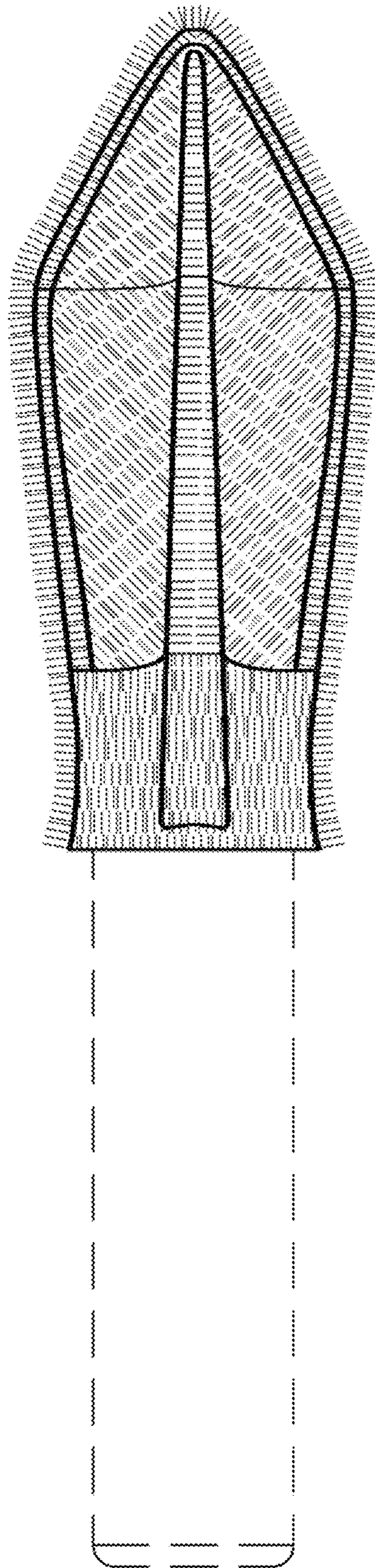

FIG. 11

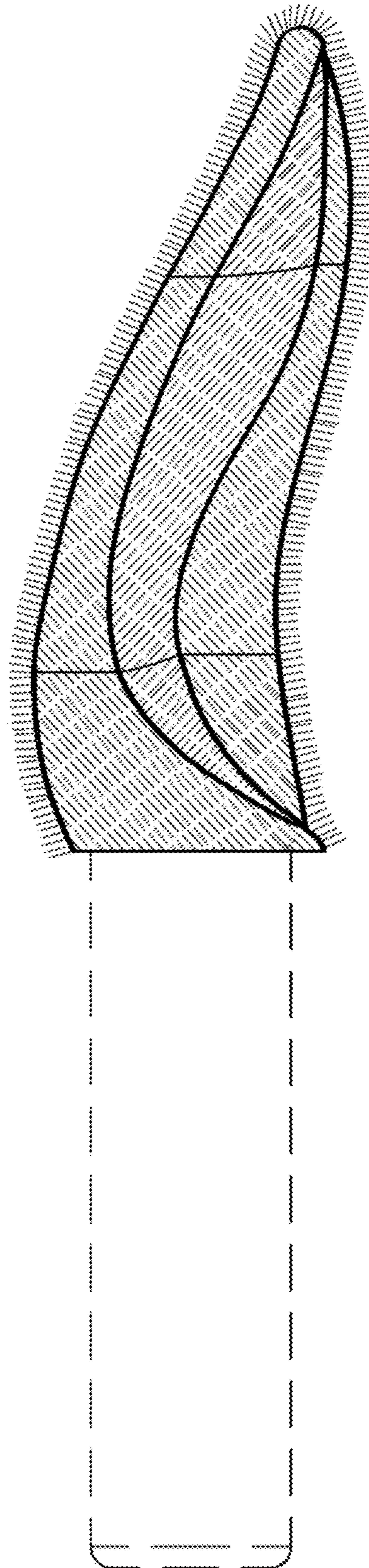

FIG. 12

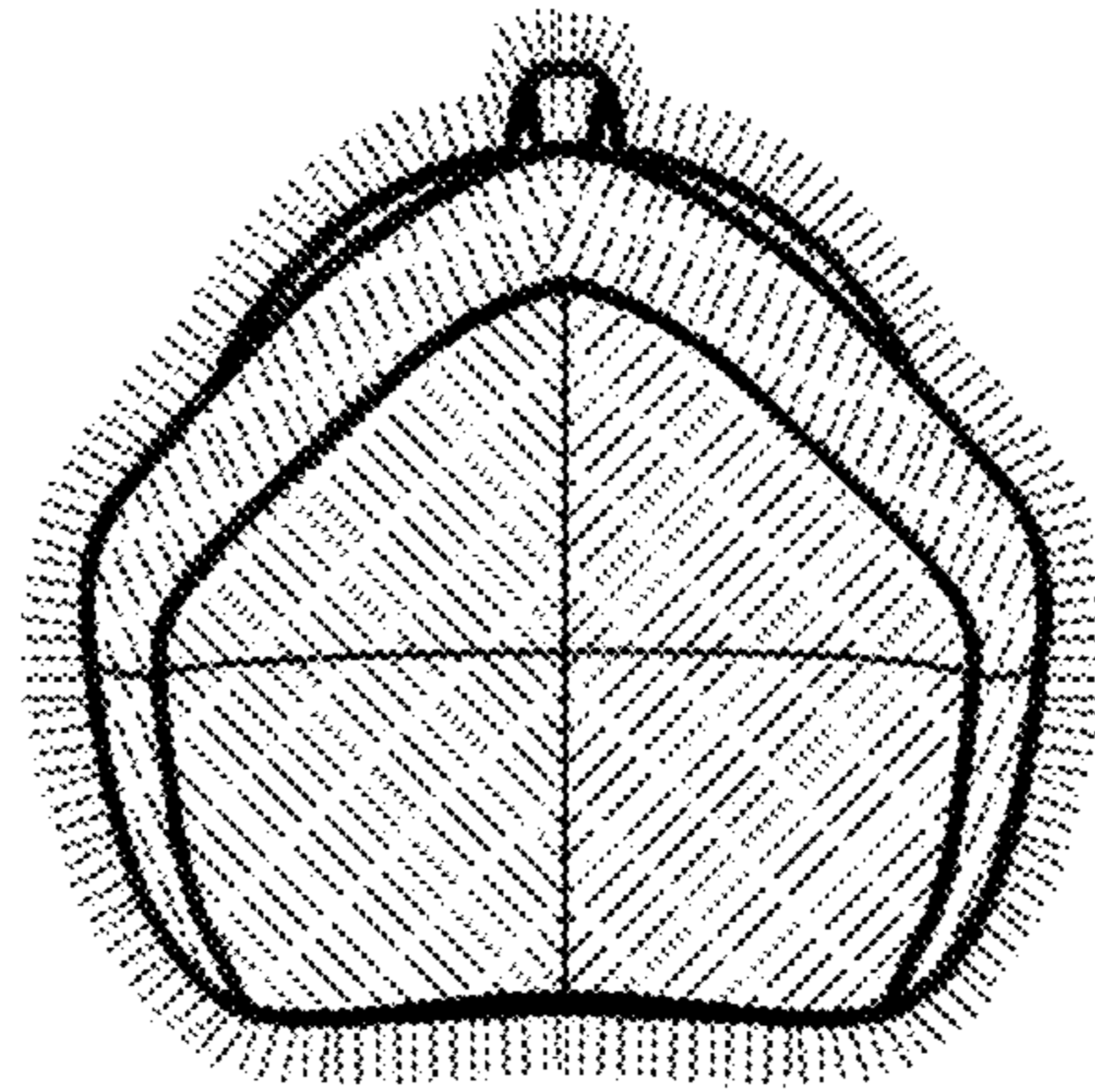

FIG. 13

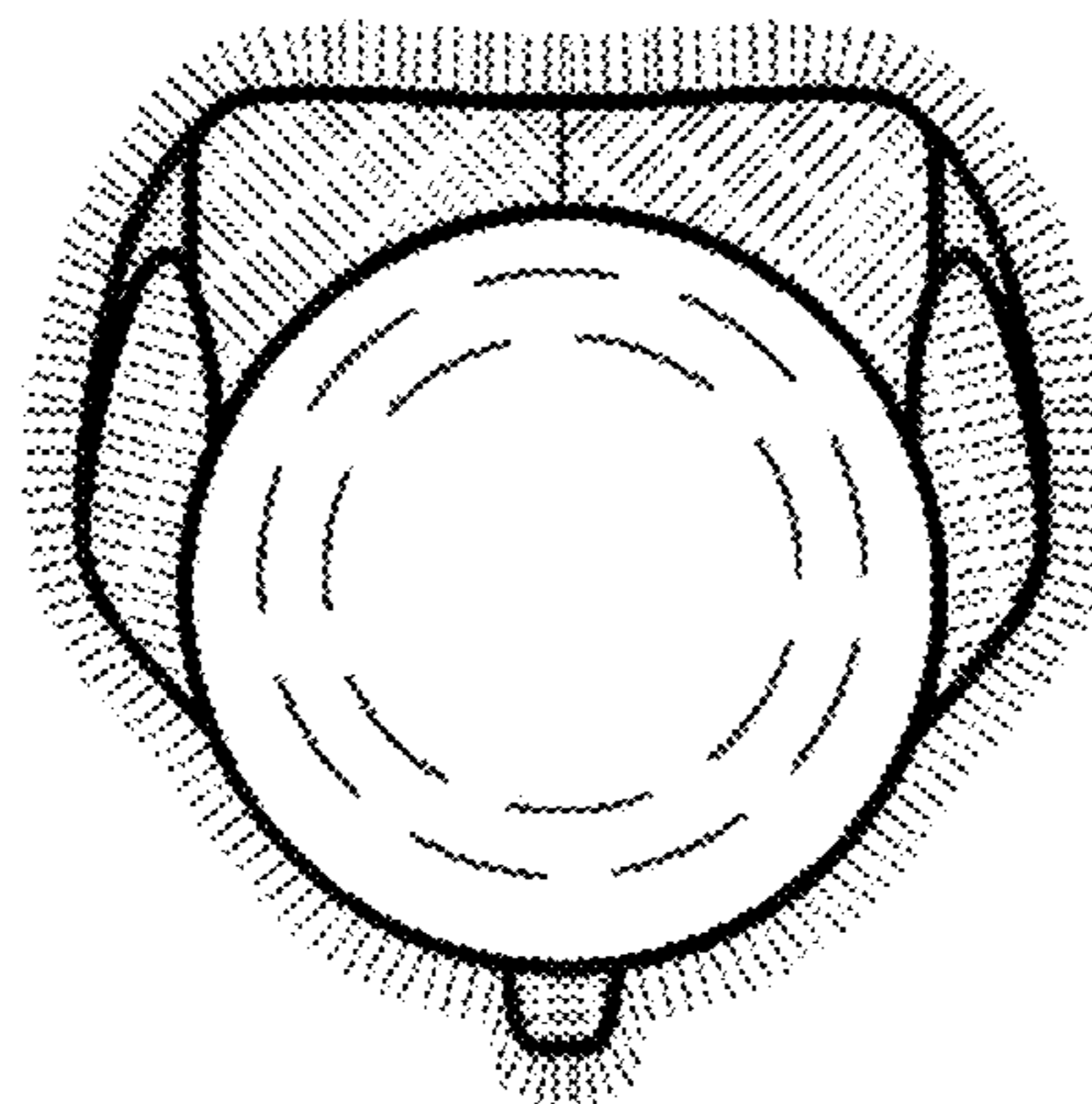

FIG. 14