



US00D949462S

(12) **United States Design Patent** (10) **Patent No.:** **US D949,462 S**  
**Wang** (45) **Date of Patent:** **\*\* Apr. 19, 2022**

(54) **ELECTRONIC ATOMIZING DEVICE**  
(71) Applicant: **Shenzhen Verdewell Technology Limited**, Shenzhen (CN)  
(72) Inventor: **Jianliang Wang**, Shenzhen (CN)  
(73) Assignee: **SHENZHEN VERDEWELL TECHNOLOGY LIMITED**, Shenzhen (CN)  
(\*\*) Term: **15 Years**  
(21) Appl. No.: **29/729,826**  
(22) Filed: **Mar. 30, 2020**  
(30) **Foreign Application Priority Data**

Oct. 31, 2019 (CN) ..... 201930597629.2

(51) **LOC (13) Cl.** ..... **27-02**

(52) **U.S. Cl.**  
USPC ..... **D27/162**

(58) **Field of Classification Search**  
USPC ..... D27/100, 101, 162, 163, 164, 165, 166, D27/167, 168, 169, 170, 171, 172, 173, D27/174, 175, 176, 177, 178, 179, 180, D27/181, 182, 183, 184, 185, 186, 187, D27/188, 189, 190, 191, 192, 193; D28/91.1; D23/360, 362; D24/110, D24/110.4, 110.5, 110.6, 113  
CPC ..... A24F 40/10; A24F 40/40; A24F 40/46; A24F 40/42; A24F 40/44; A24F 40/485; A24F 40/50; A24F 40/60; A24F 40/90; A24F 40/53; A24F 40/70; A24F 40/48; A24F 40/51; A24F 40/57; A24F 40/05; A24F 40/65; A24F 40/20; A24F 47/002; A24F 40/30; A24F 7/00; A24F 47/00; A24F 1/32; A24F 40/00; A24F 40/49; A24F 40/85; A24F 40/95; A24F 7/04; A24F 9/16; A24F 47/008; A24F 15/015; A24F 40/465; A24F 42/60; A24F 1/02; A24F 2700/03; A24F 47/006; A24F 13/00; A24F 13/14; A24F 15/01; A24F

(56) **References Cited**

U.S. PATENT DOCUMENTS

D373,536 S \* 9/1996 Kokenge ..... D9/529  
D627,663 S \* 11/2010 Kruezkamp ..... D9/687  
D852,408 S \* 6/2019 Nettenstrom ..... D27/101  
D853,632 S \* 7/2019 Qiu ..... D27/101  
D853,633 S \* 7/2019 Zeng ..... D27/162  
D880,053 S \* 3/2020 Han ..... D27/162  
D885,657 S \* 5/2020 Lai ..... D27/194  
D887,630 S \* 6/2020 Lai ..... D27/162  
D887,631 S \* 6/2020 Lai ..... D27/162  
D900,385 S \* 10/2020 Wang ..... D27/162  
D901,761 S \* 11/2020 Zhu ..... D27/162  
D903,936 S \* 12/2020 He ..... D27/162  
D904,680 S \* 12/2020 Pan ..... D27/162  
D908,953 S \* 1/2021 Fornarelli ..... D27/162  
D918,466 S \* 5/2021 Yan ..... D27/162  
D919,879 S \* 5/2021 Han ..... D27/162  
2019/0313693 A1 \* 10/2019 Wei ..... A24F 40/40  
2020/0138106 A1 \* 5/2020 Huang ..... A24F 40/49  
2020/0397043 A1 \* 12/2020 Li ..... A24F 40/44  
2021/0000181 A1 \* 1/2021 Li ..... A24F 40/46

FOREIGN PATENT DOCUMENTS

CN 201830198246.3 \* 2/2019  
CN 201930241197.1 \* 9/2019  
CN 201930306976.5 \* 4/2020  
CN 201930580640.8 \* 5/2020

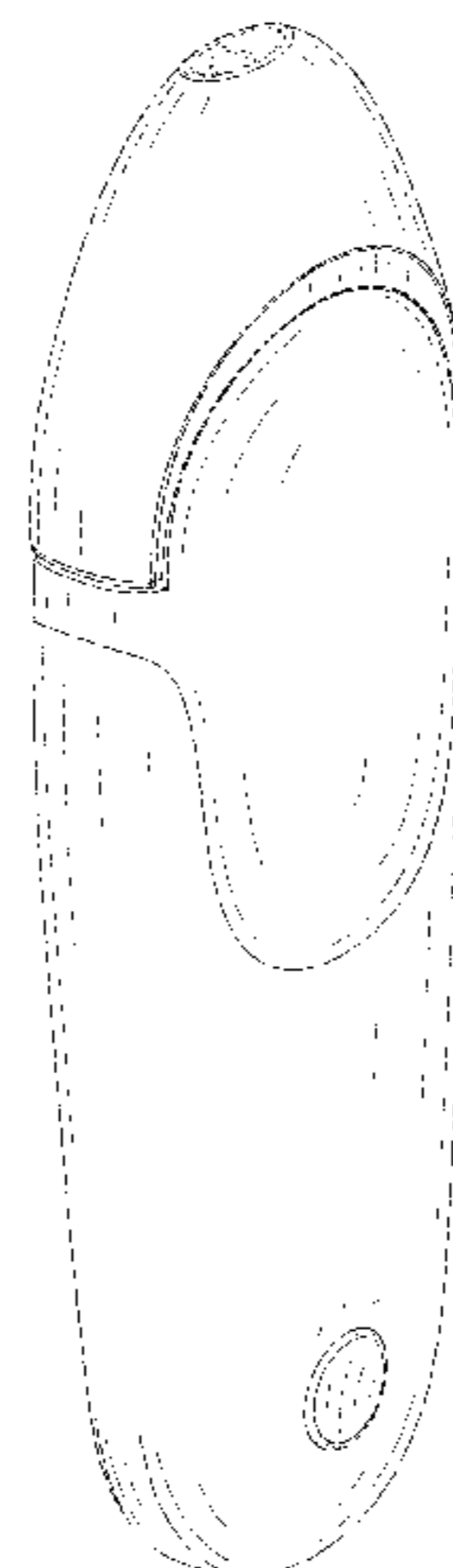

OTHER PUBLICATIONS

Motivate Moti One Kit Unboxing. By Smoking Mermaid. Dated Dec. 18, 2019. Found online [Mar. 8, 2021]. <https://www.youtube.com/watch?v=DQebFaLzwwQ> (Year: 2019).\*

Kangertech Surf Kit. By Xin Xu. Dated Jan. 15, 2019. Found online [Mar. 8, 2021]. [https://www.youtube.com/watch?v=Ax\\_bT4rdxvo](https://www.youtube.com/watch?v=Ax_bT4rdxvo) (Year: 2019).\*

Smooth Operator—NJOY Ace Pod Device Review. By VapingwithTwisted420. Dated Nov. 8, 2018. Found online [Mar. 8, 2021]. <https://www.youtube.com/watch?v=zdLrL3KfS8U> (Year: 2018).\*

\* cited by examiner

*Primary Examiner* — Marissa J Cash

*Assistant Examiner* — William B Melliar

(57) **CLAIM**

The ornamental design for an electronic atomizing device, as shown and described.

**DESCRIPTION**

FIG. 1 is a perspective view of an electronic atomizing device shown in an assembled configuration of use;  
FIG. 2 is another perspective view thereof;  
FIG. 3 is a front elevational view thereof;  
FIG. 4 is a rear elevational view thereof;  
FIG. 5 is a left side elevational view thereof;  
FIG. 6 is a right side elevational view thereof;  
FIG. 7 is a top plan view thereof;  
FIG. 8 is a bottom plan view thereof;

FIG. 9 is a perspective view of an electronic atomizing device, with the atomizer component shown removed from the electronic atomizing device for clarity of disclosure;  
FIG. 10 is another perspective view thereof;  
FIG. 11 is a front elevational view thereof;  
FIG. 12 is a rear elevational view thereof;  
FIG. 13 is a left side elevational view thereof;  
FIG. 14 is a right side elevational view thereof;  
FIG. 15 is a top plan view thereof;  
FIG. 16 is a bottom plan view thereof;  
FIG. 17 is a perspective view of an electronic atomizing device, with the power supply device component shown removed from the electronic atomizing device for clarity of disclosure;  
FIG. 18 is another perspective view thereof;  
FIG. 19 is a front elevational view thereof;  
FIG. 20 is a rear elevational view thereof;  
FIG. 21 is a left side elevational view thereof;  
FIG. 22 is a right side elevational view thereof;  
FIG. 23 is a top plan view thereof;  
FIG. 24 is a bottom plan view thereof; and,  
FIG. 25 is an enlarged view of area 25 circumscribed in FIG. 9.

The broken lines consisting of evenly spaced dash lines in the drawings depict portions of the electronic atomizing device that form no part of the claimed design.

The dot-dash broken lines in the drawings depict the boundaries of the enlarged views and form no part of the claimed design.

**1 Claim, 25 Drawing Sheets**

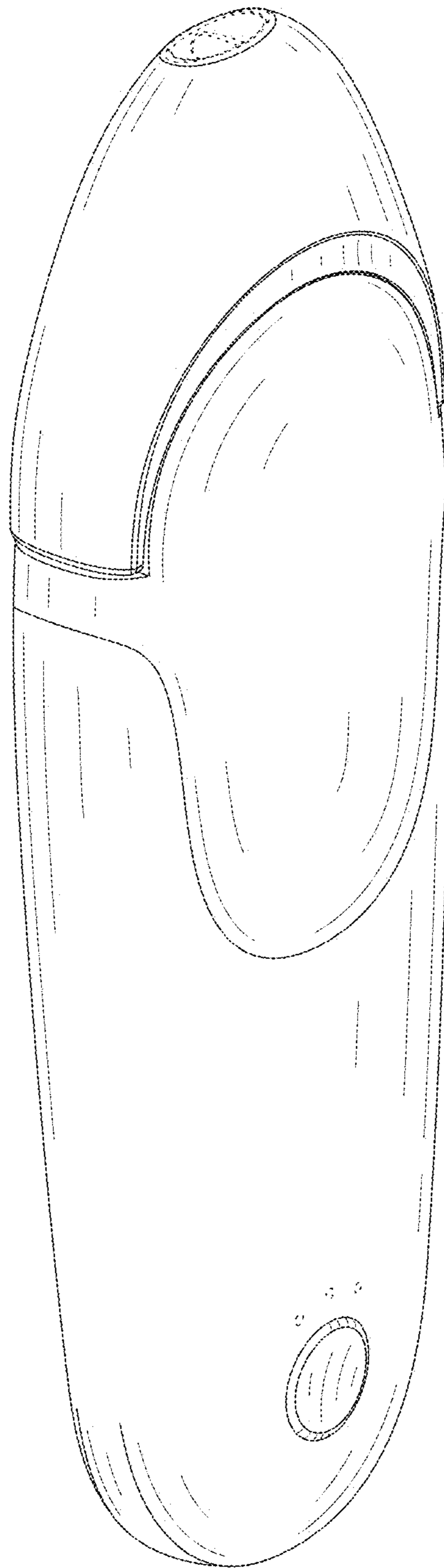

FIG. 1

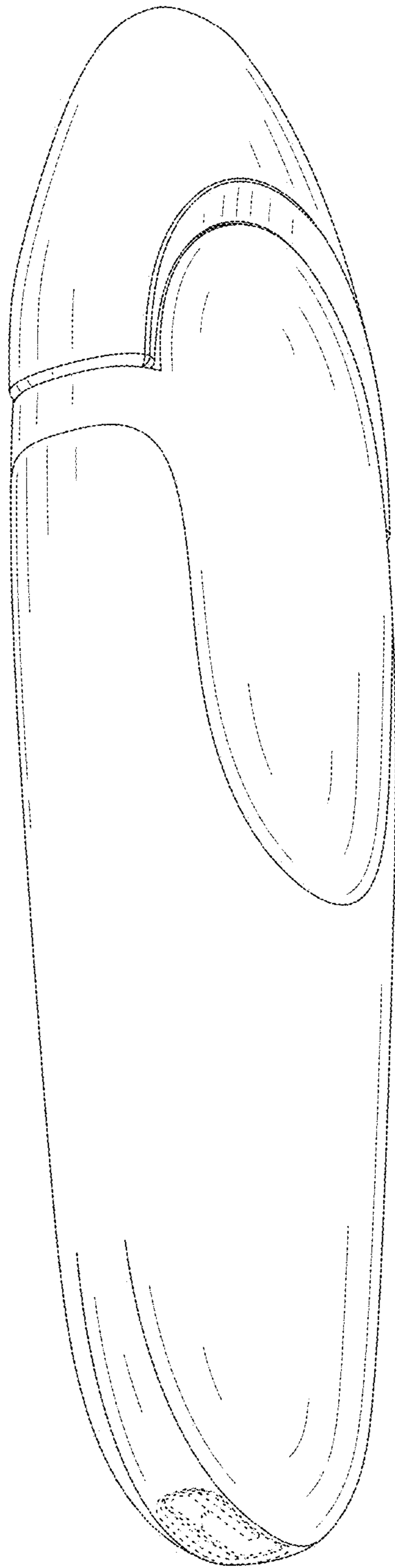

FIG. 2

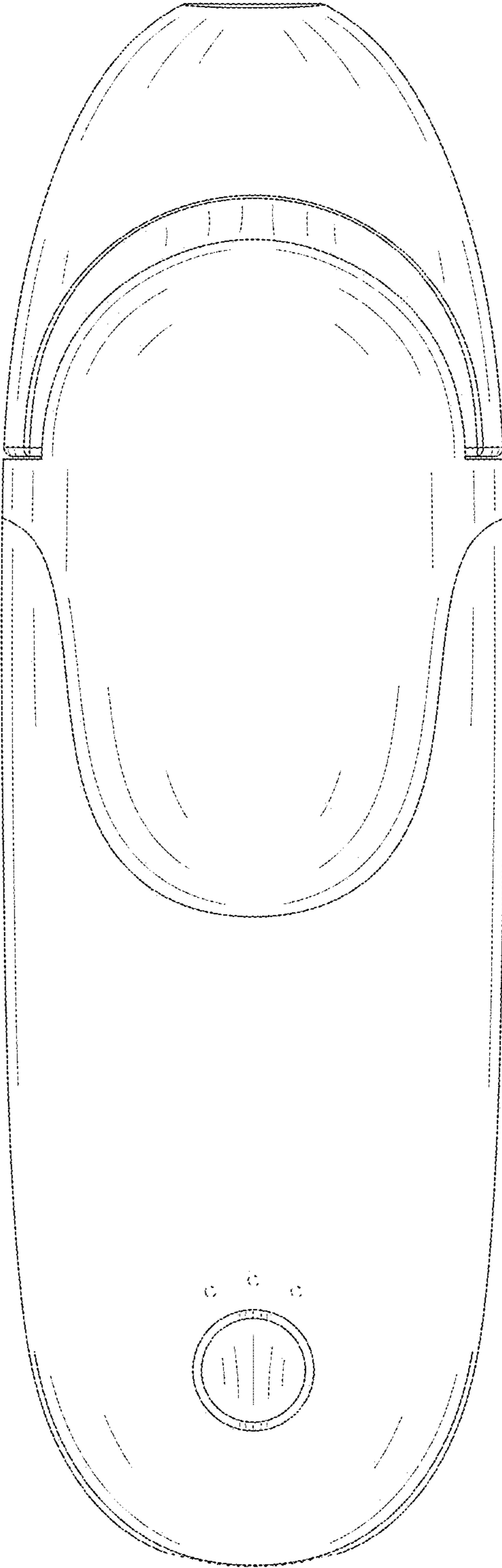

FIG. 3

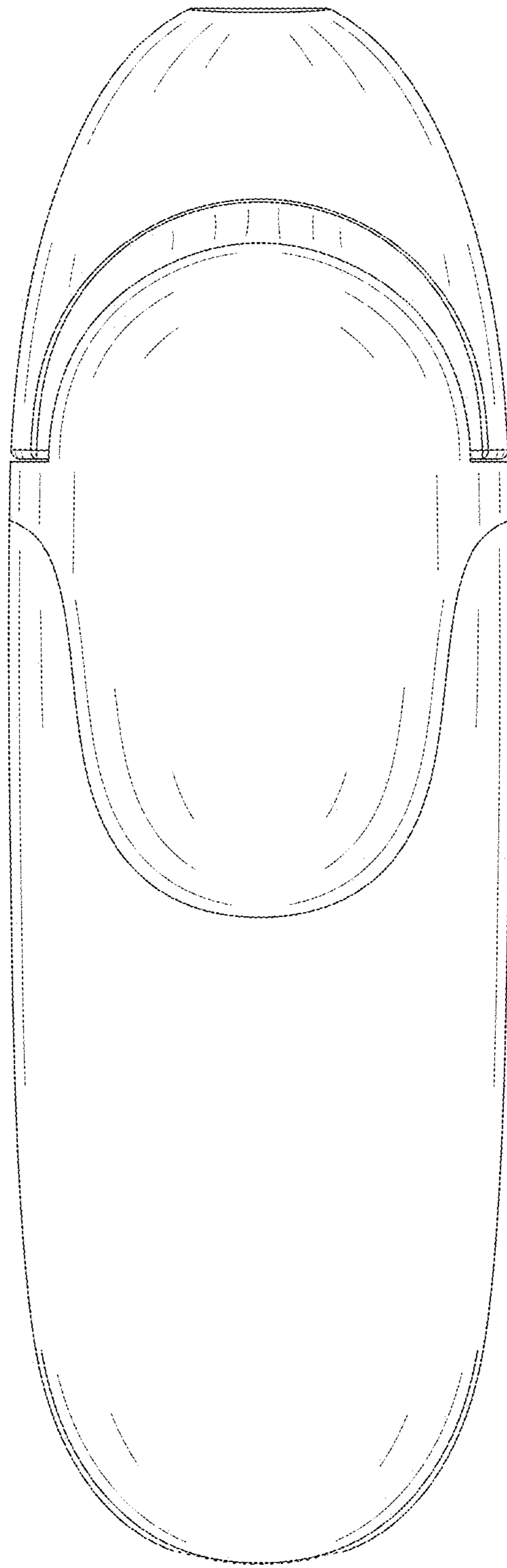

FIG. 4

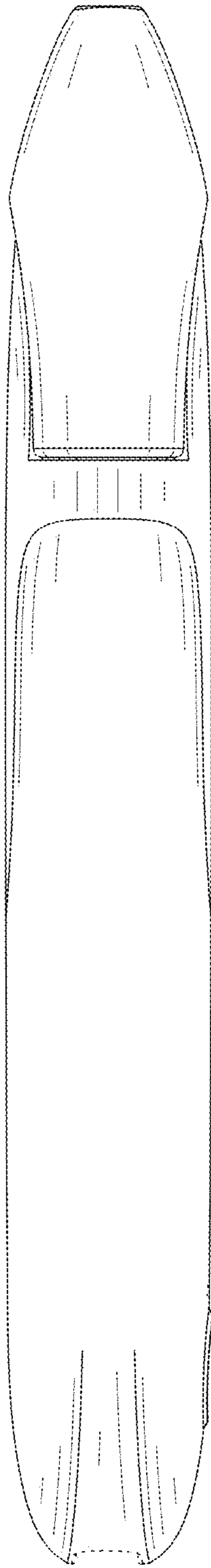

FIG. 5

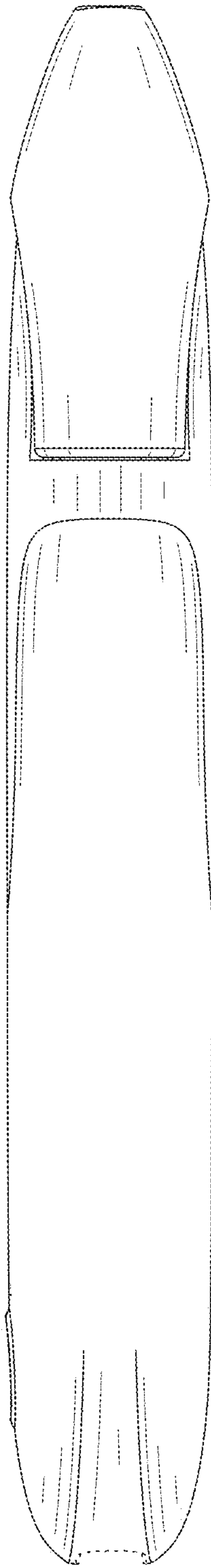

FIG. 6



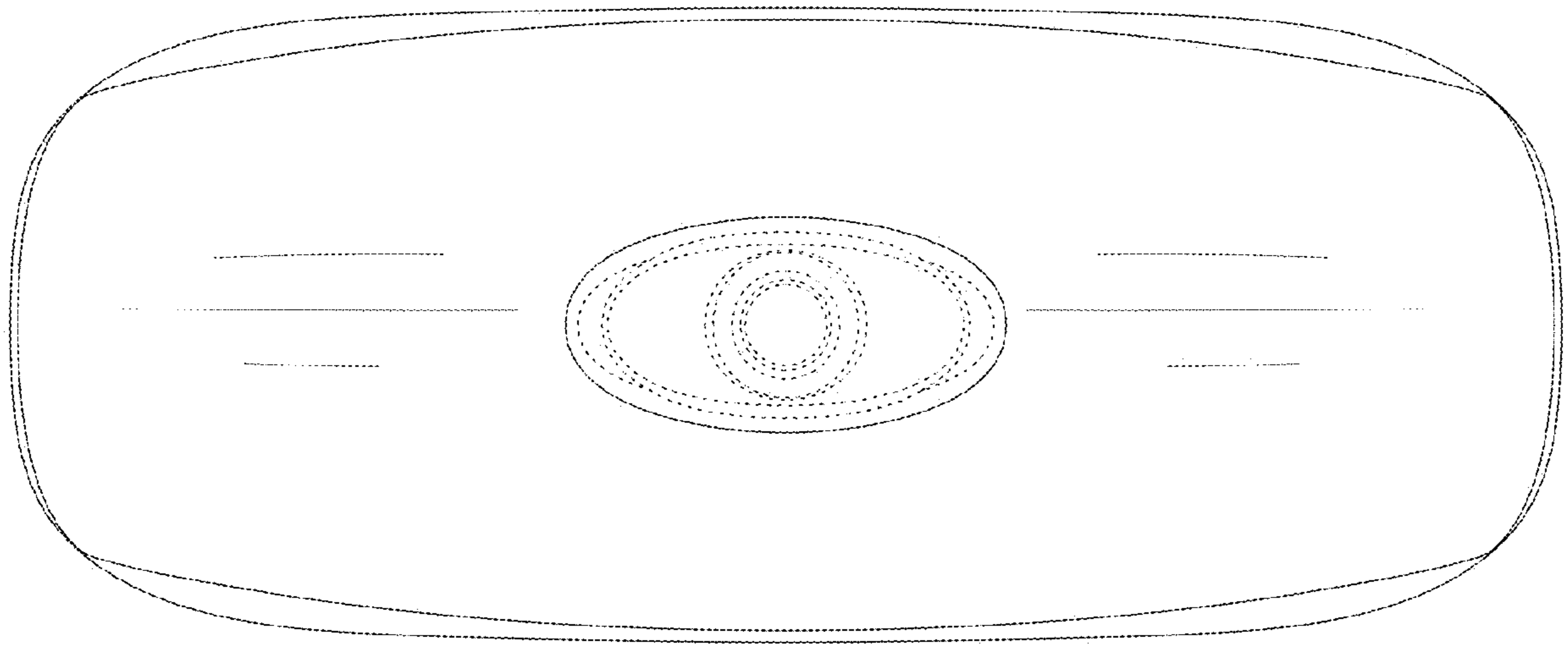

FIG. 7

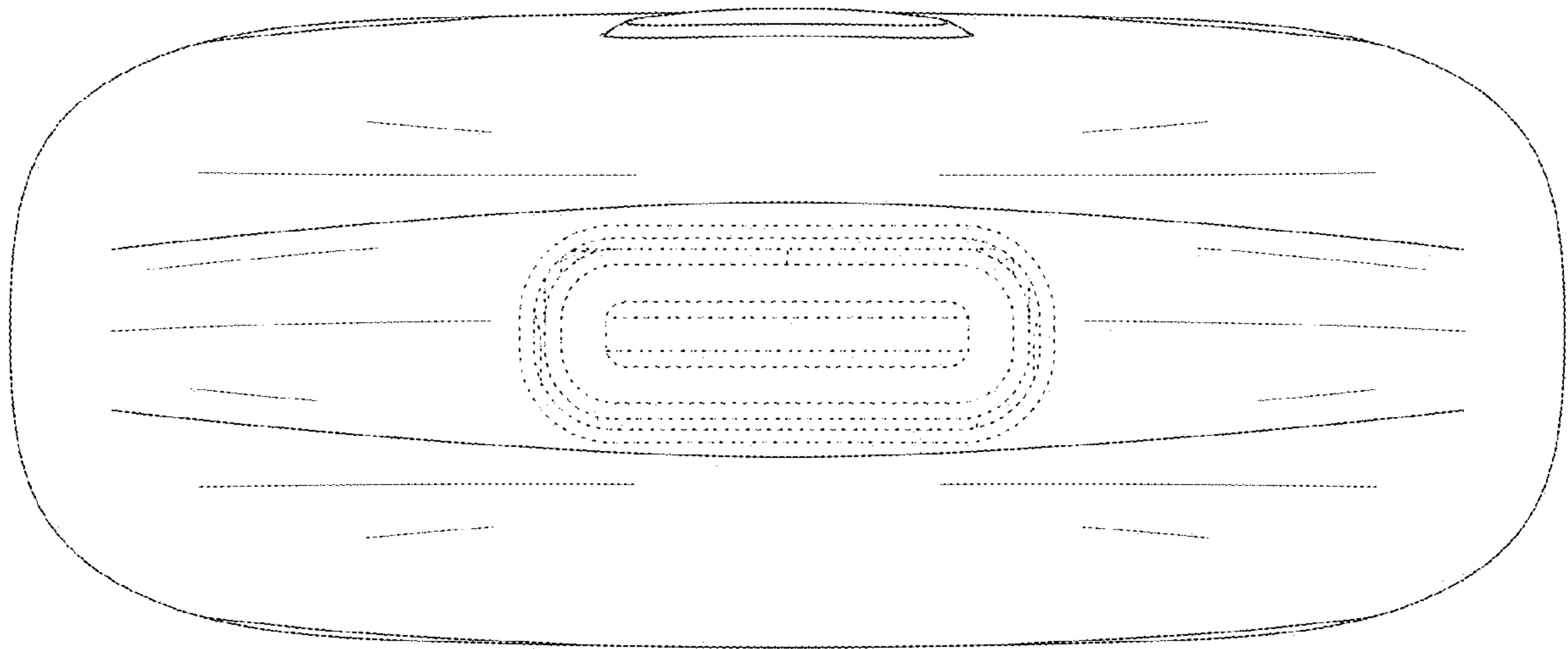

FIG. 8

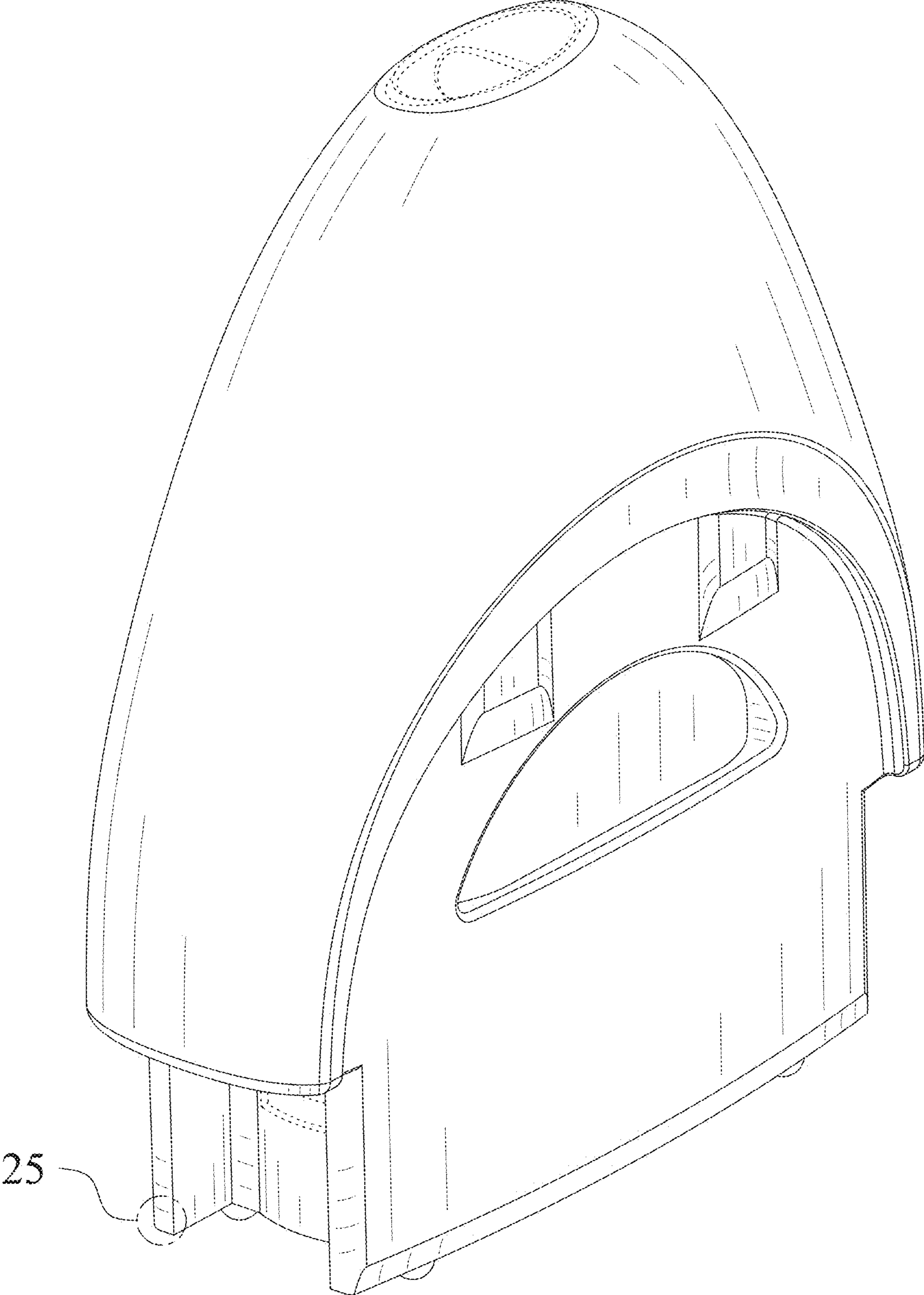

FIG. 9

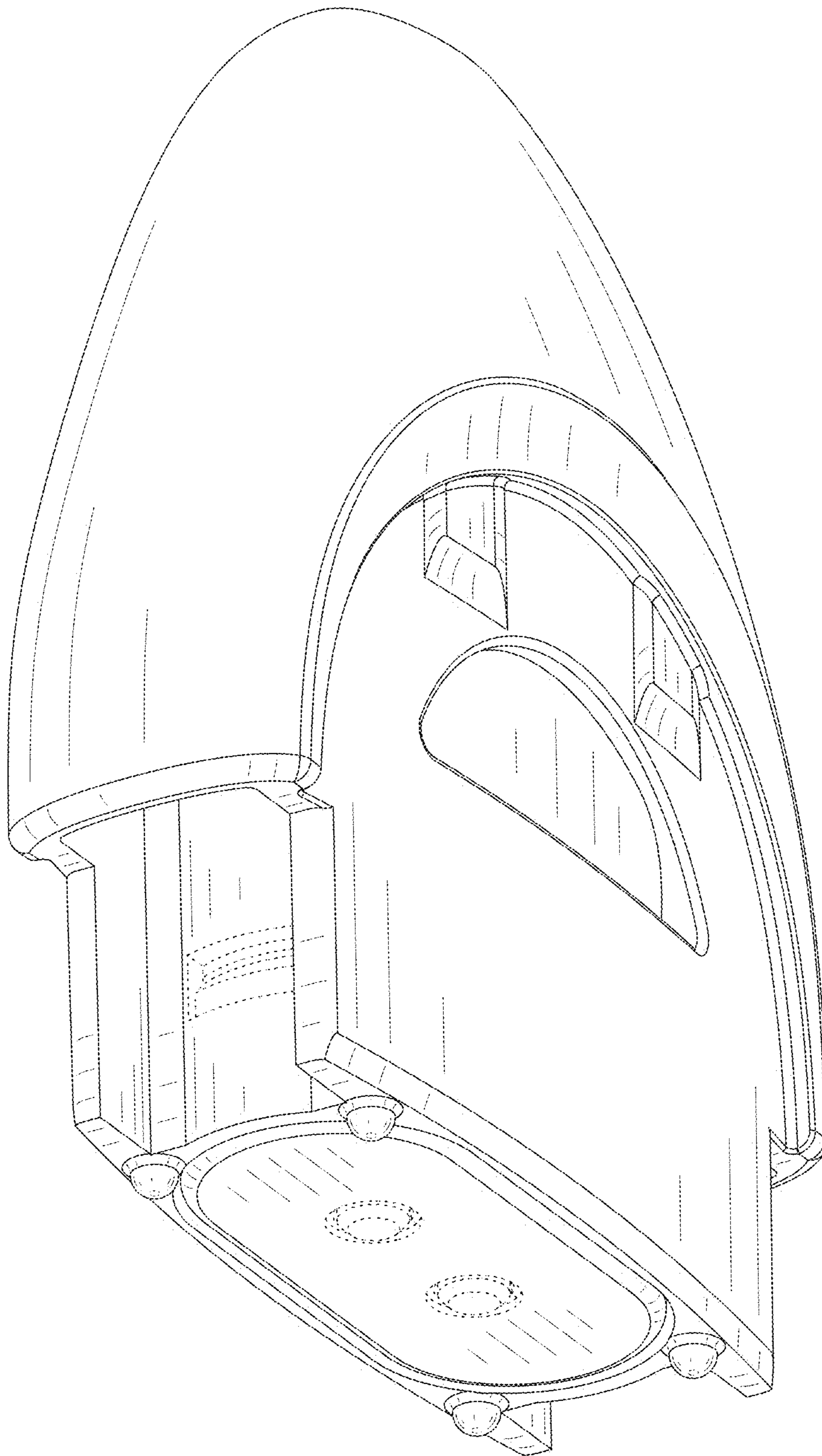

FIG. 10

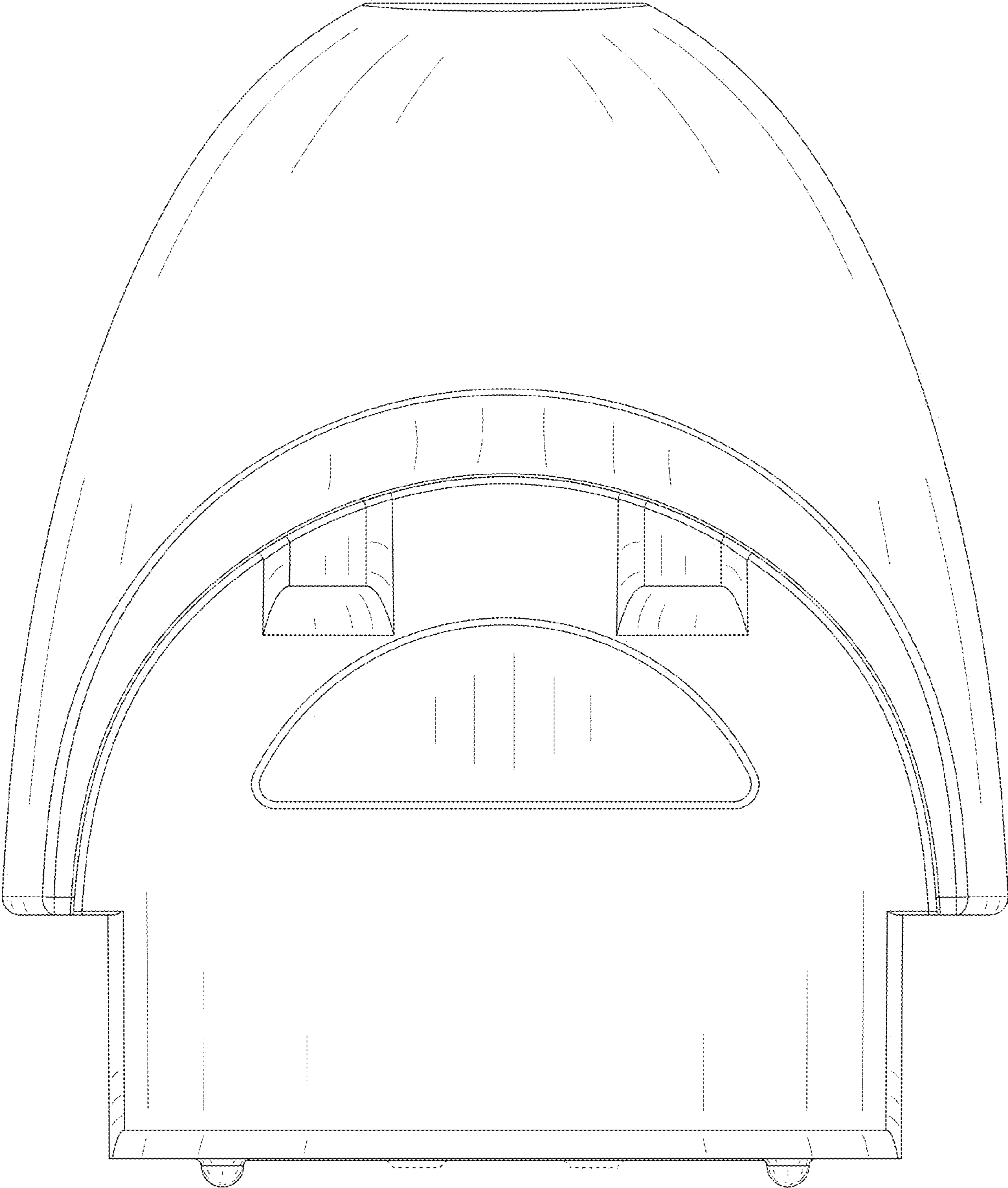

FIG. 11

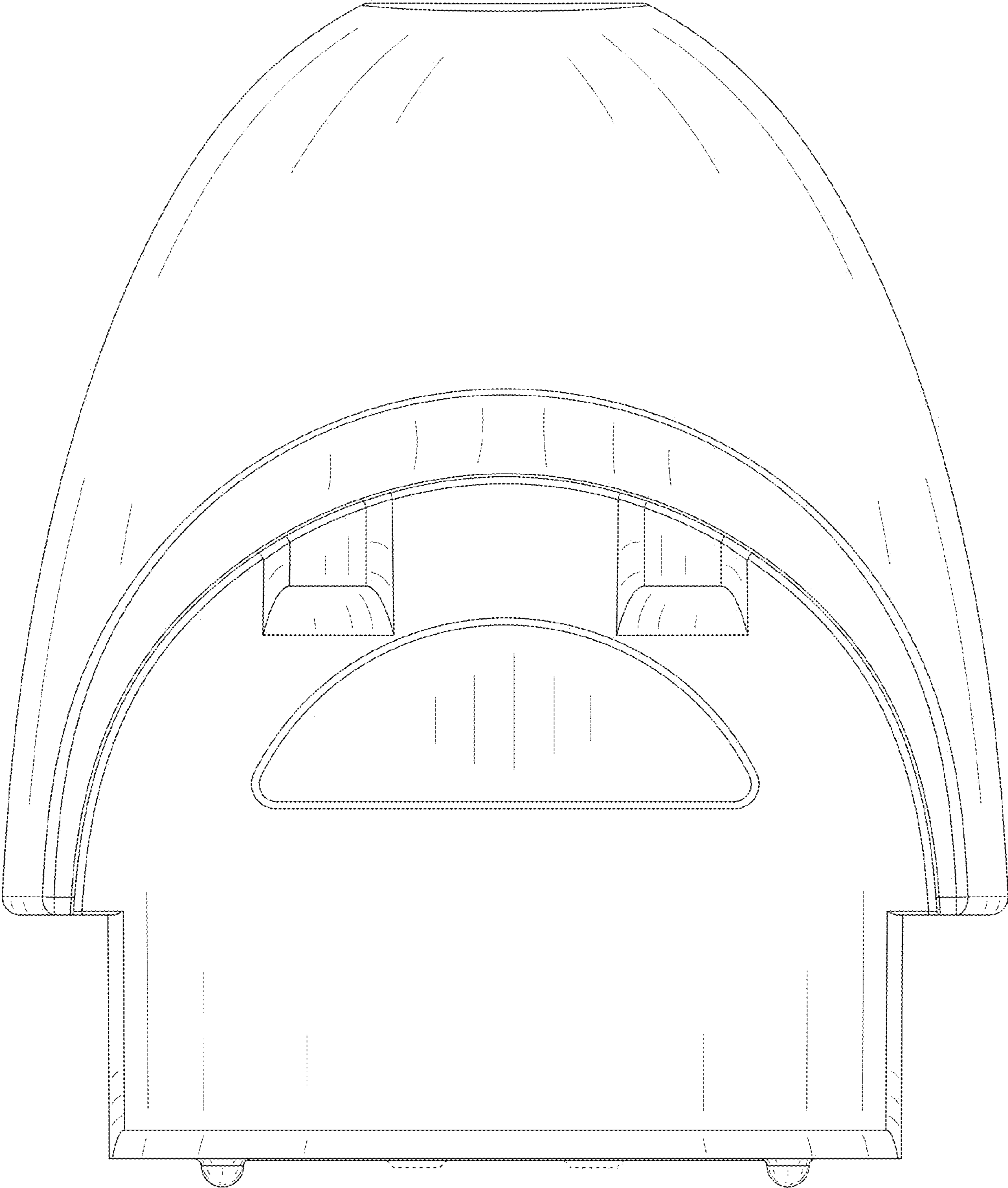

FIG. 12

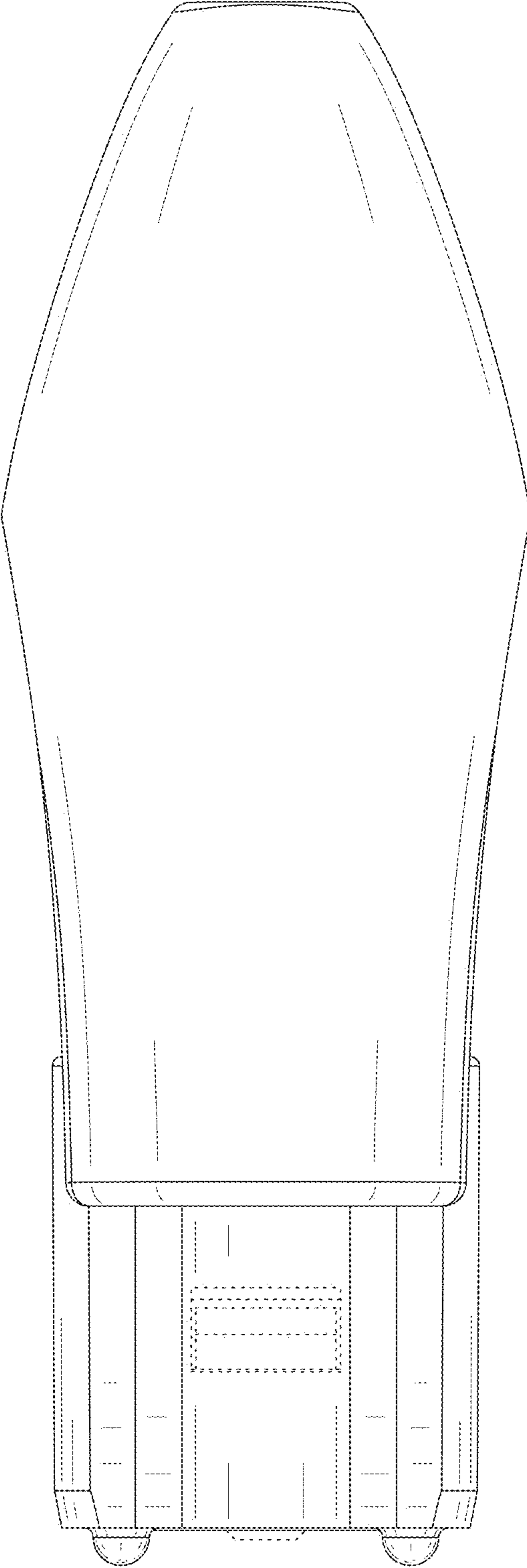

FIG. 13

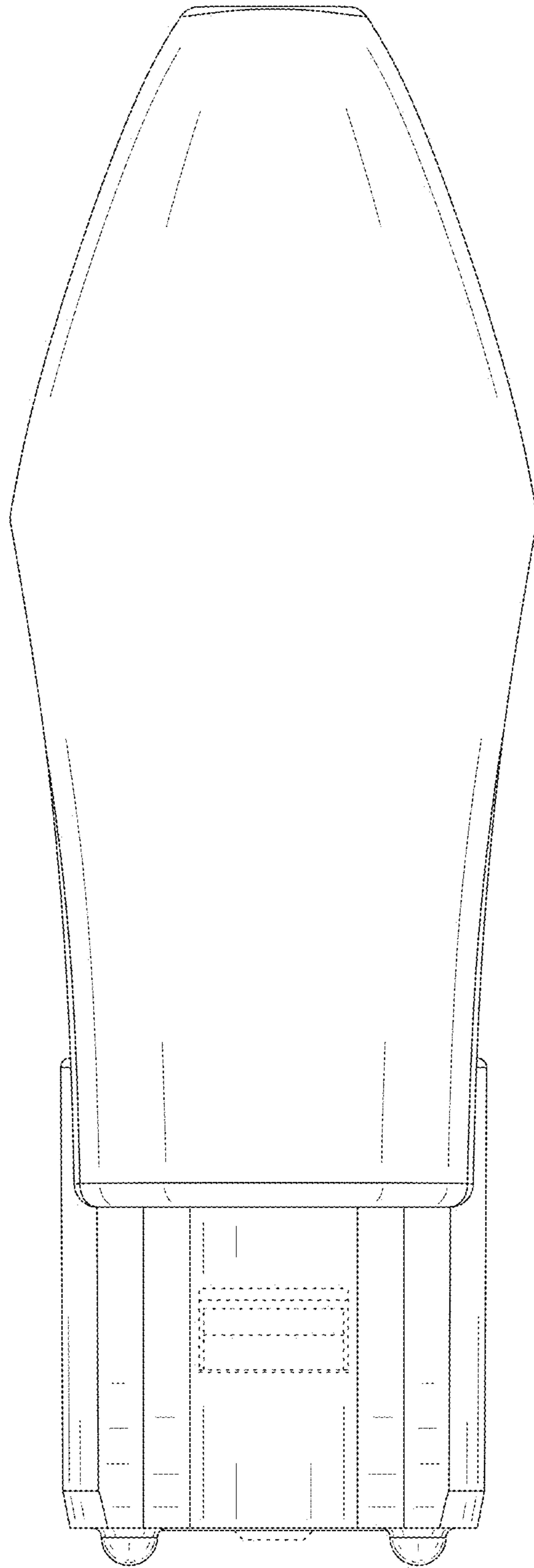

FIG. 14



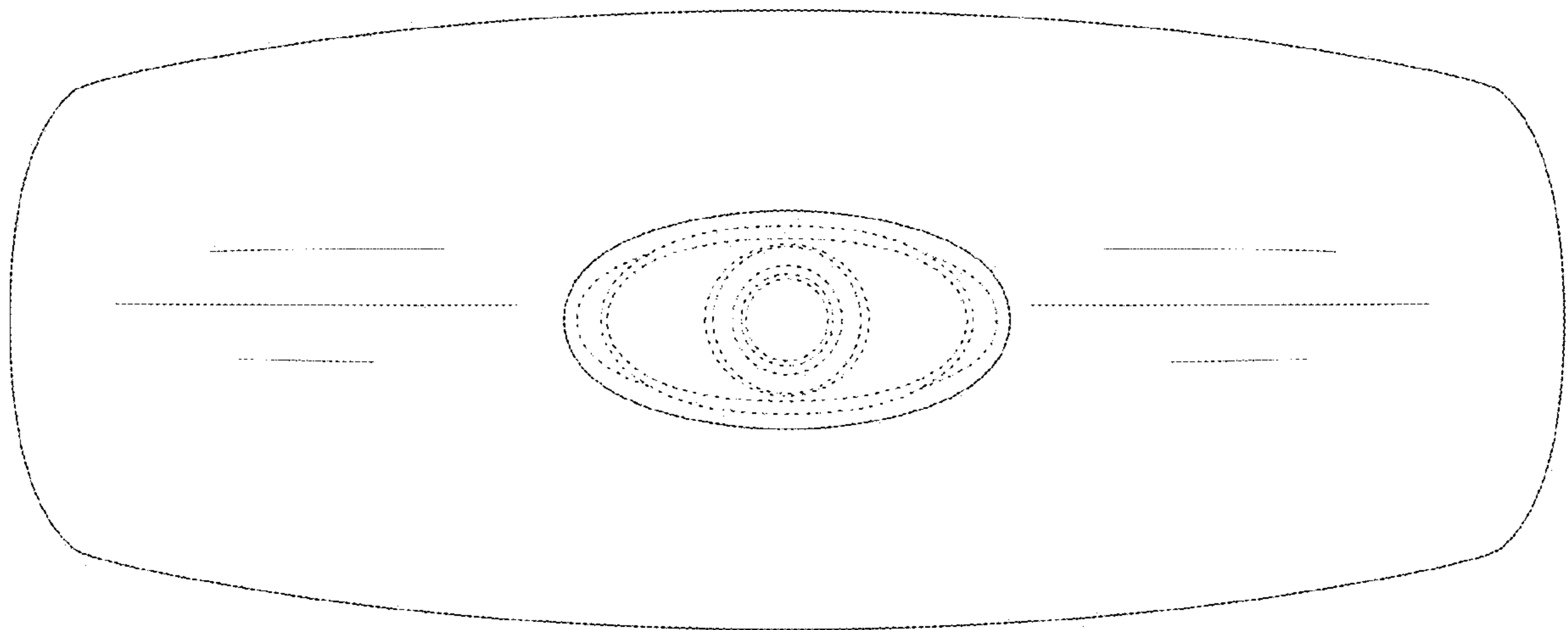

FIG. 15

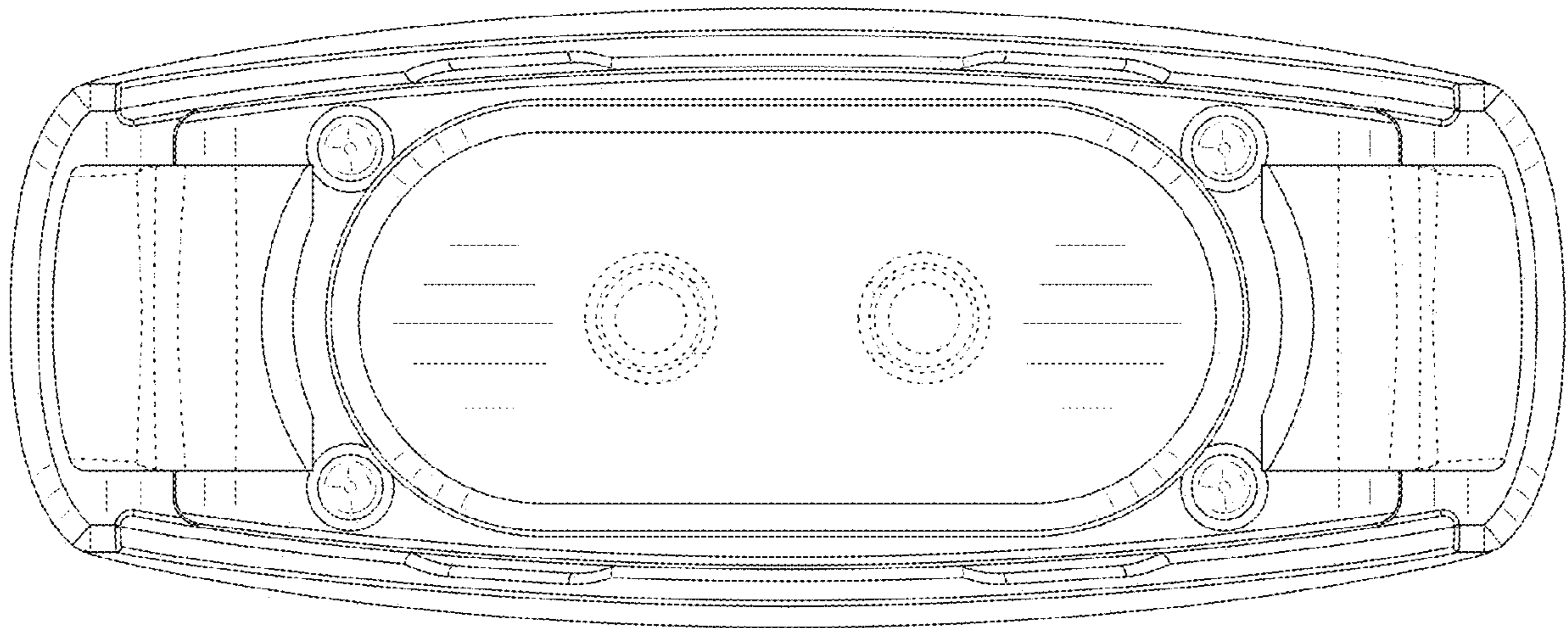

FIG. 16

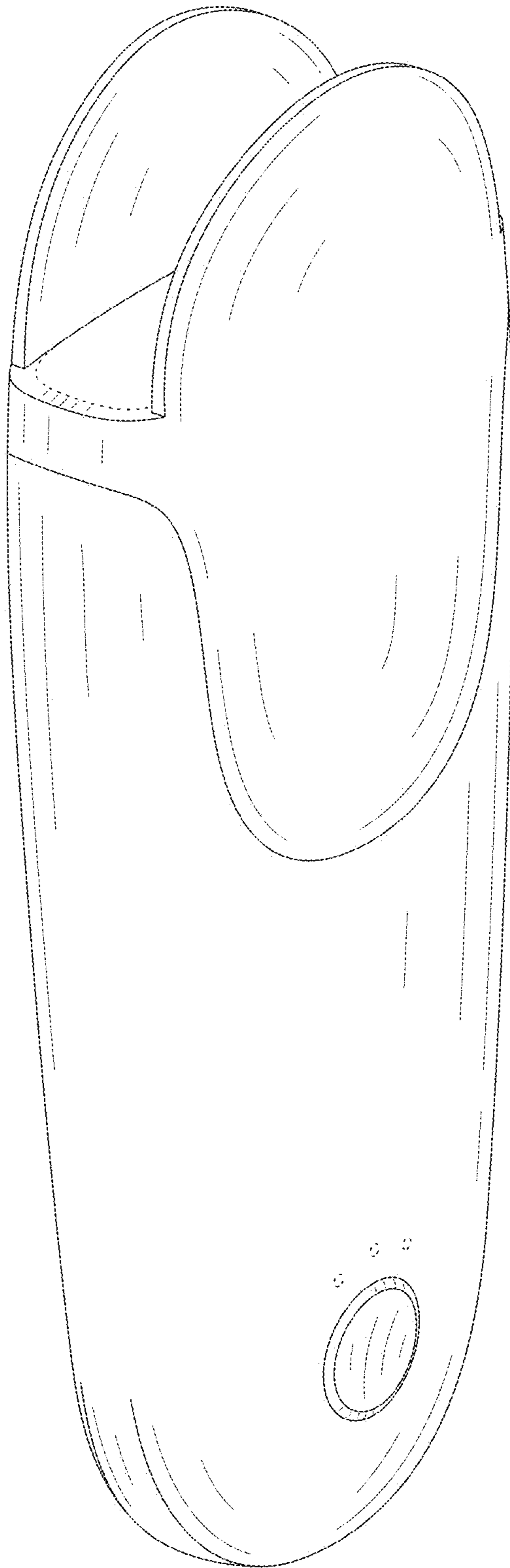

FIG. 17

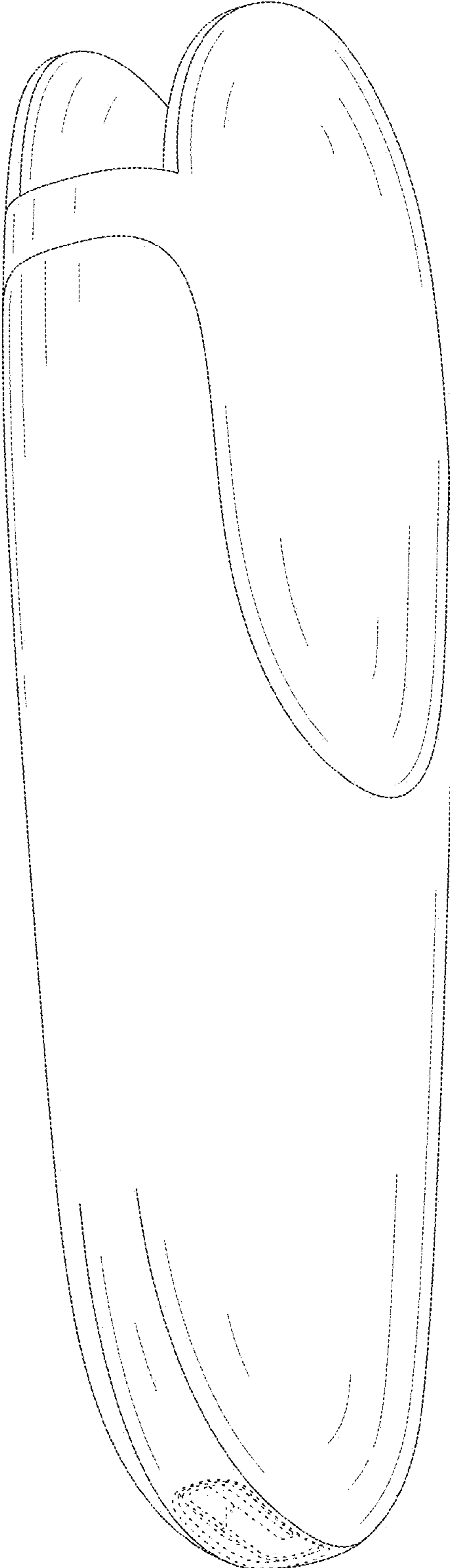

FIG. 18

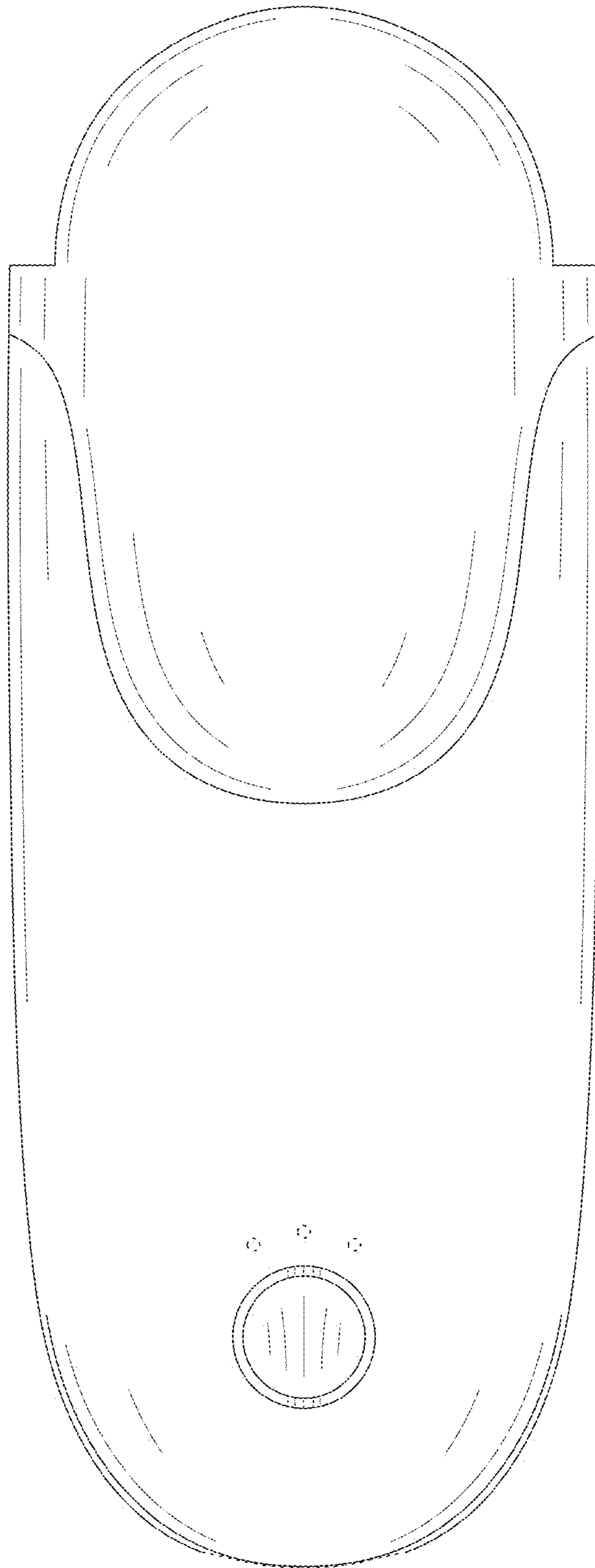

FIG. 19

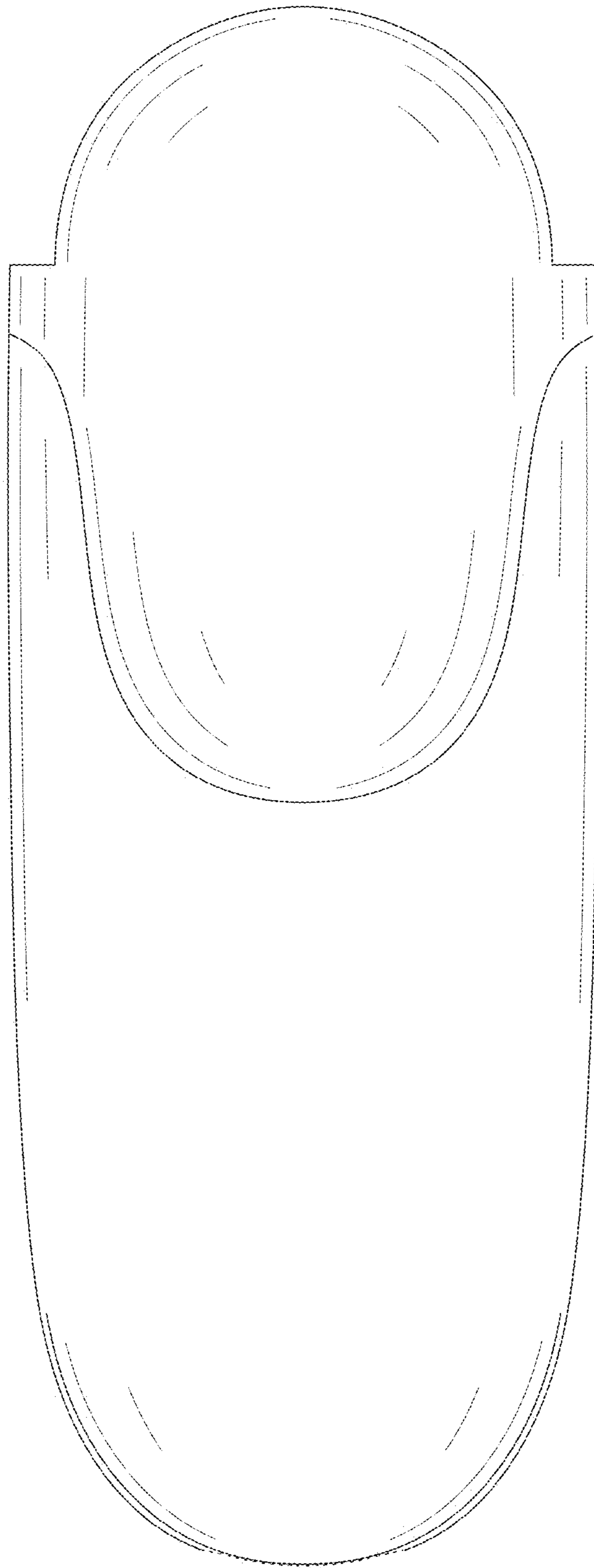

FIG. 20

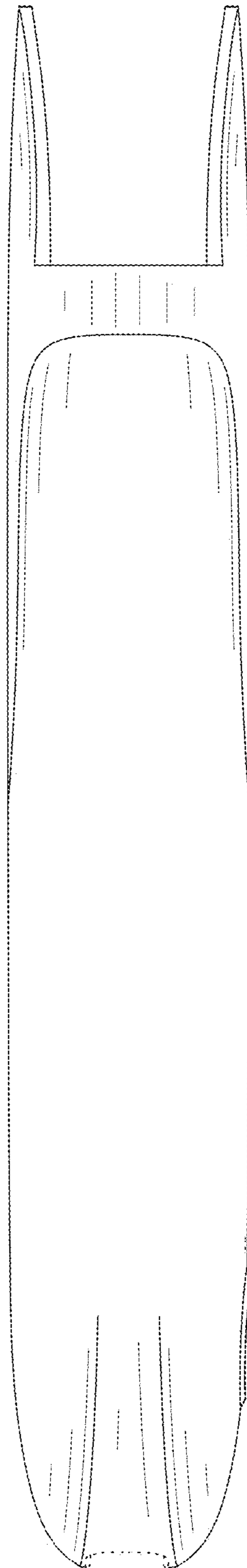

FIG. 21

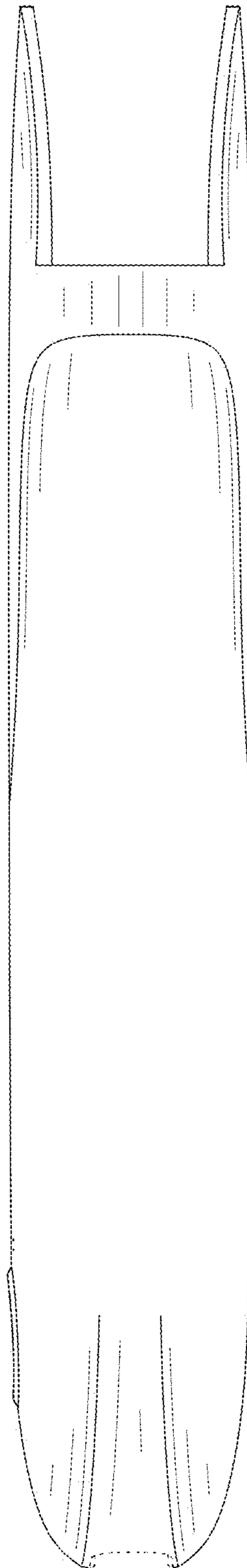

FIG. 22



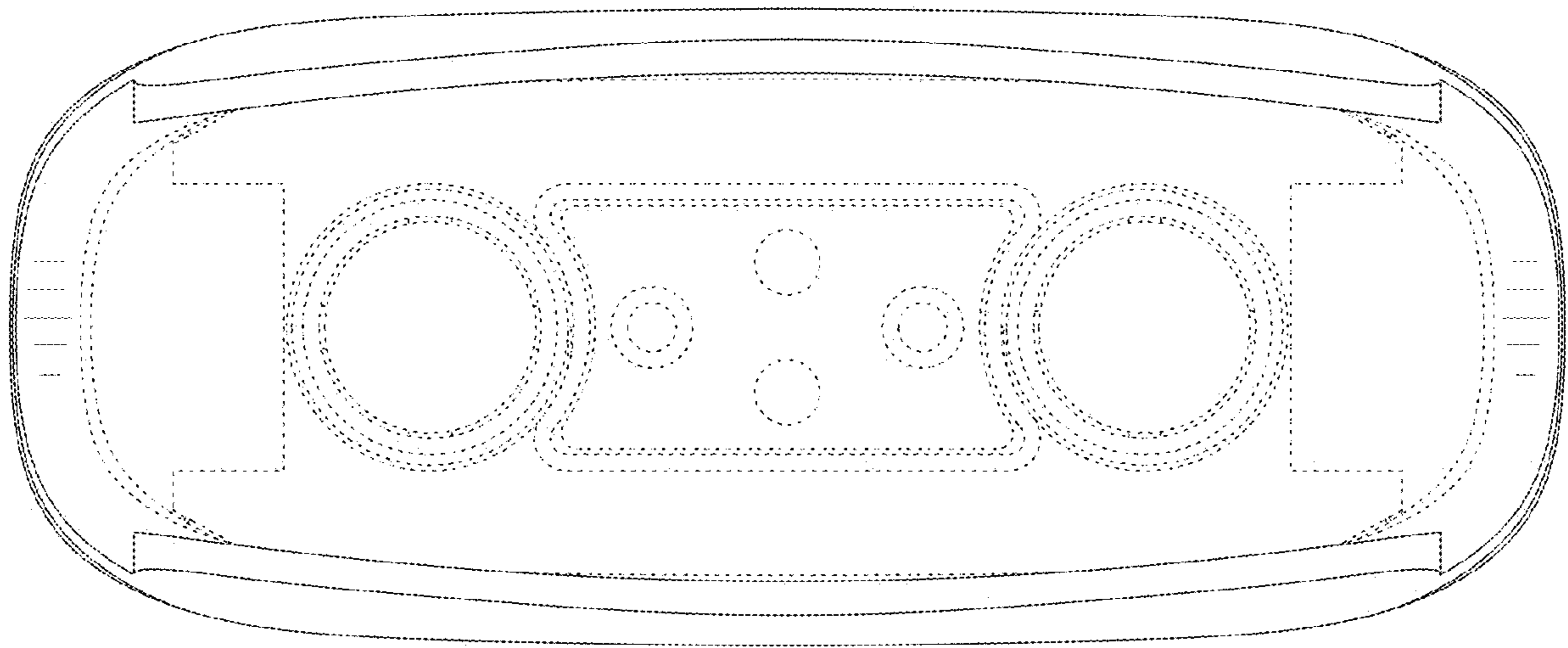

FIG. 23

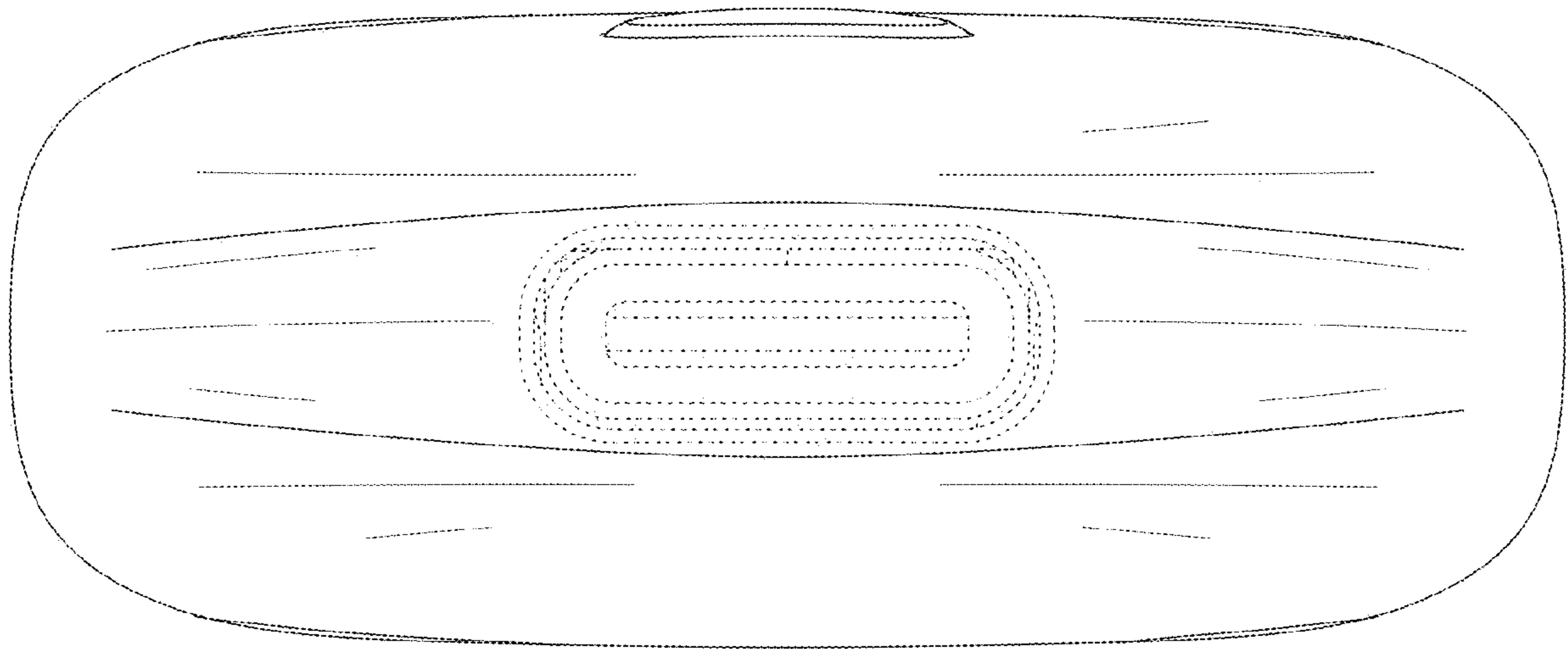

FIG. 24

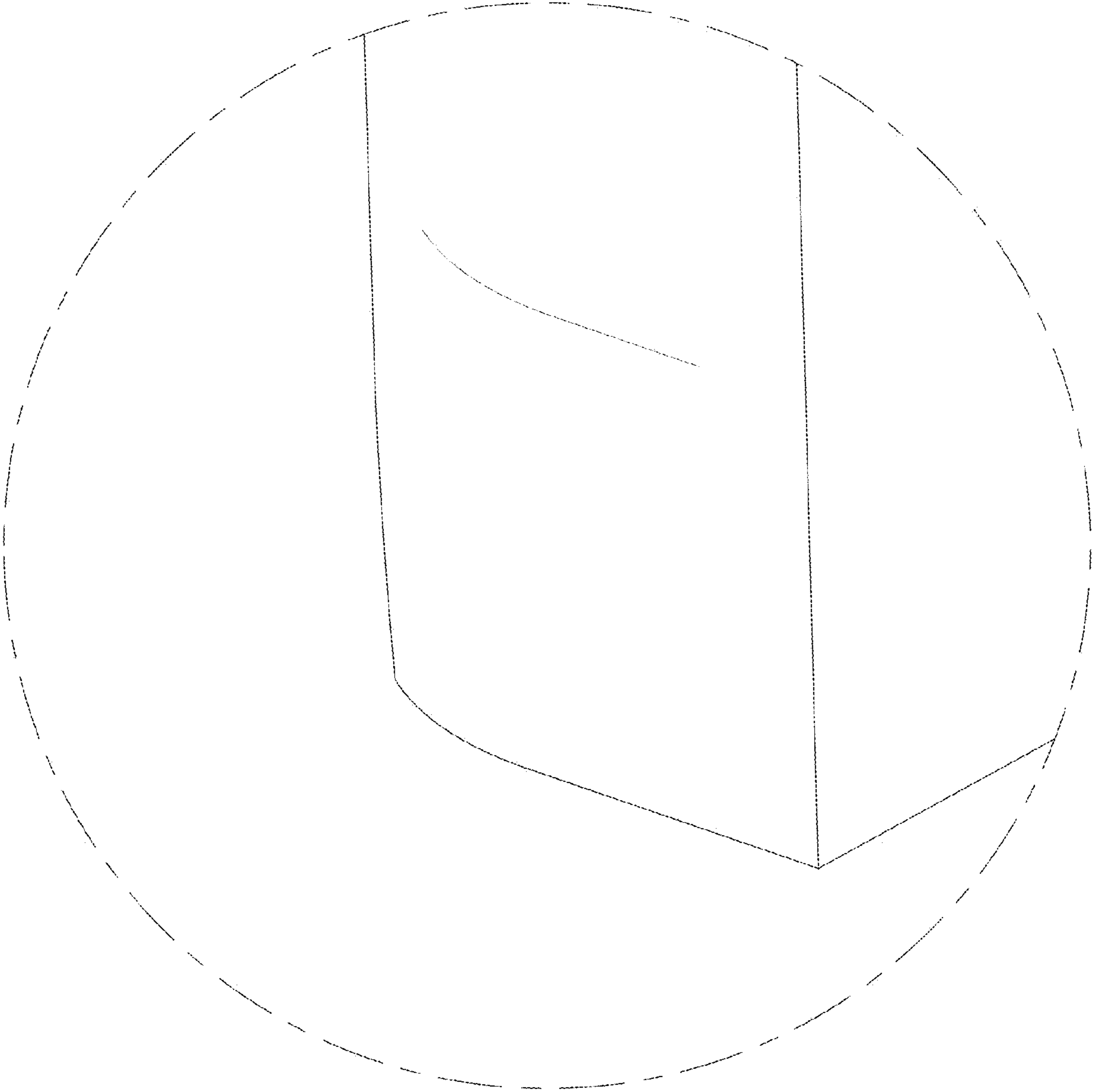

FIG. 25