



US00D949457S

(12) **United States Design Patent** (10) **Patent No.:** **US D949,457 S**
Henriksen et al. (45) **Date of Patent:** **** Apr. 19, 2022**

(54) **LAMP**

(71) Applicant: **Space Copenhagen Design ApS**,
Copenhagen (DK)

(72) Inventors: **Signe Bindslev Henriksen**,
Copenhagen (DK); **Peter Bundgaard Rützou**,
Copenhagen (DK)

(73) Assignee: **SPACE COPENHAGEN DESIGN**
APS, København K (DK)

(**) Term: **15 Years**

(21) Appl. No.: **29/739,182**

(22) Filed: **Jun. 23, 2020**

(30) **Foreign Application Priority Data**

Dec. 23, 2019 (EM) 007448618-0001

(51) **LOC (13) Cl.** **26-05**

(52) **U.S. Cl.**
USPC **D26/104**; D26/40

(58) **Field of Classification Search**

USPC D26/24, 37-52, 93-94, 104-107, 113,
D26/118-120, 123-124; D14/172,
D14/194-195, 204, 215-216; D23/366
CPC F21Y 2115/10; F21Y 2103/10; F21Y
2103/00; F21Y 2107/30; F21Y 2107/40;
F21Y 2113/13; F21Y 2103/33; F21Y
2105/10; F21Y 2113/00; F21Y 2113/17;
F21Y 2113/20; F21S 6/003; F21S 6/002;
F21S 6/00; F21S 9/02; F21S 6/005; F21S
10/023; F21S 2/00; F21S 8/03; F21S
2/005; F21S 6/001; F21S 6/006; F21S
6/008; F21S 8/036; F21S 9/022; F21S
9/037; F21V 21/26; F21V 23/04; F21V
21/06; F21V 21/30; F21V 21/22; F21V
3/00; F21V 17/007; F21V 21/403; F21V
23/002; F21V 23/0485; F21V 33/0012;
F21V 5/04; F21V 7/0091; F21V 1/16;
F21V 21/14; F21V 21/35; F21V 21/40;
F21V 23/003; F21V 23/005; F21V

23/0435; F21V 23/0442; F21V 23/06;
F21V 27/00; F21V 29/51; F21V 31/005;
F21V 33/0024; F21V 33/0048; F21V
14/02; F21V 14/04; F21V 14/06; F21V
14/08; F21V 15/01; F21V 17/02; F21V
17/104; F21V 17/105; F21V 17/18; F21V
19/02; F21V 1/00; F21V 1/06; F21V
1/12; F21V 1/143; F21V 1/22; F21V
21/005; F21V 21/08; F21V 21/0885;
F21V 21/116; F21V 21/15; F21V 21/28;
F21V

(Continued)

(56) **References Cited**

U.S. PATENT DOCUMENTS

D298,573 S * 11/1988 Komamura D26/37
D464,454 S * 10/2002 Suzuki D26/40

(Continued)

FOREIGN PATENT DOCUMENTS

CN 202030286636.3 * 10/2020
CN 202130328257.0 * 9/2021

Primary Examiner — Marissa J Cash
Assistant Examiner — William B Melliar
(74) *Attorney, Agent, or Firm* — Cantor Colburn LLP

(57) **CLAIM**

We claim, the ornamental design for a lamp, as shown and described.

DESCRIPTION

FIG. 1 is a perspective view of a lamp, showing our new design;
FIG. 2 is a front view thereof;
FIG. 3 is a side view thereof, the opposite side view being a mirror image;

(Continued)

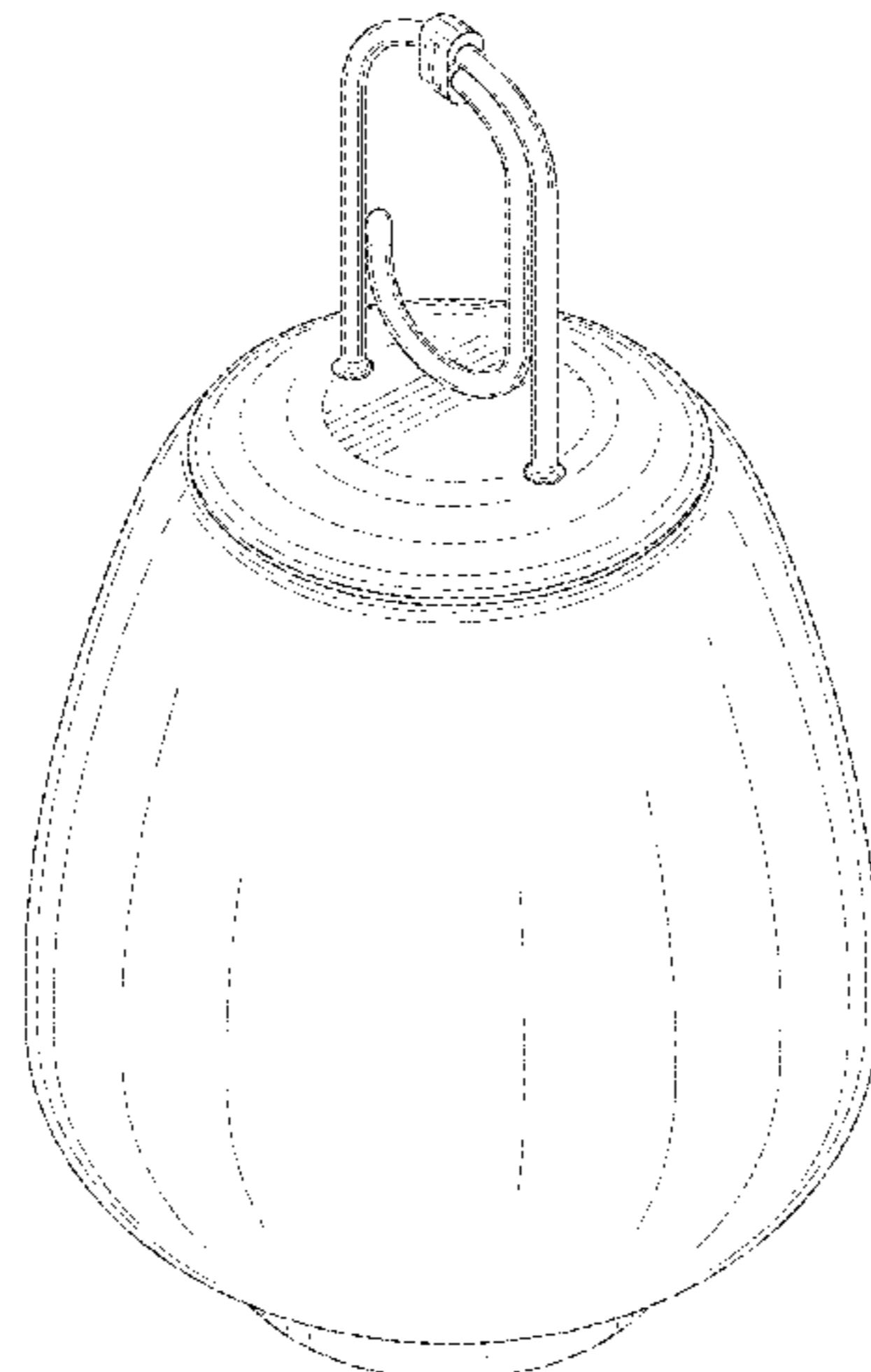

FIG. 4 is a rear view thereof;
FIG. 5 is a top view thereof; and,
FIG. 6 is a bottom view thereof.

1 Claim, 6 Drawing Sheets

(58) **Field of Classification Search**

CPC 21/29; F21V 21/38; F21V 23/026; F21V
23/0414; F21V 23/0464; F21V 29/503;
F21V 29/508; F21V 29/73; F21V 33/004;
F21V 33/0052; F21V 33/0076; F21V
5/00; F21V 7/0008; F21V 7/0016; F21V
7/0083; F21V 7/05; F21V 7/10; F21V
9/00; F21V 9/40

See application file for complete search history.

(56)

References Cited

U.S. PATENT DOCUMENTS

D603,374	S	*	11/2009	Peters	D14/216
D605,337	S	*	12/2009	Zhang	D26/93
D652,972	S	*	1/2012	Lee	D26/41
D766,878	S	*	9/2016	Park	D14/216
D783,872	S	*	4/2017	Aksnes	D26/41
D791,992	S	*	7/2017	Hsu	D26/41
D815,335	S	*	4/2018	Lin	D26/110
D838,257	S	*	1/2019	Manz	D14/216
D845,527	S	*	4/2019	Hsu	D26/41
D861,964	S	*	10/2019	Lin	D26/110
D903,173	S	*	11/2020	Zhu	D26/41
D915,123	S	*	4/2021	Dos Santos Sabino Serra	D7/348
D929,559	S	*	8/2021	Ren	D23/366

* cited by examiner

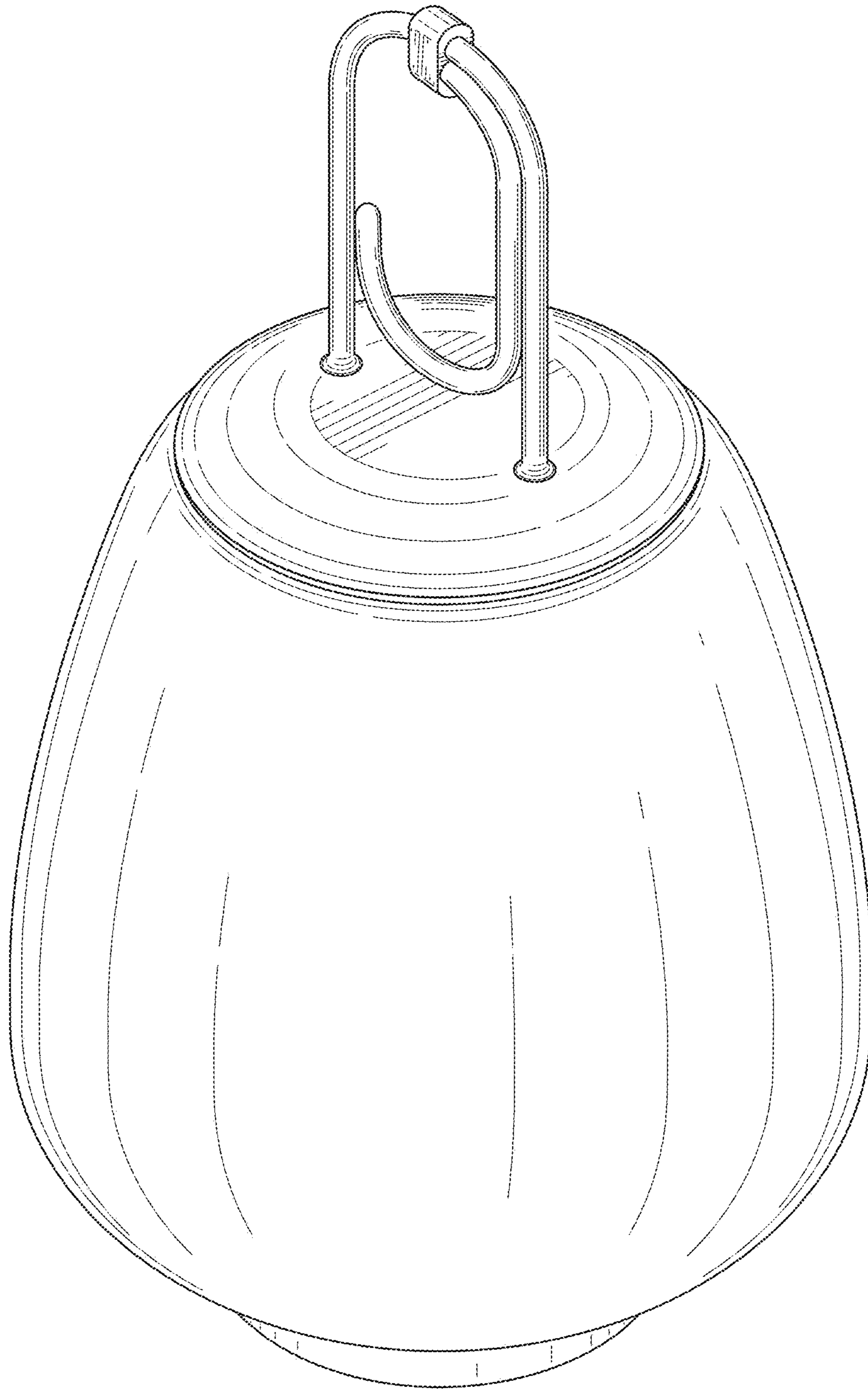

FIG. 1

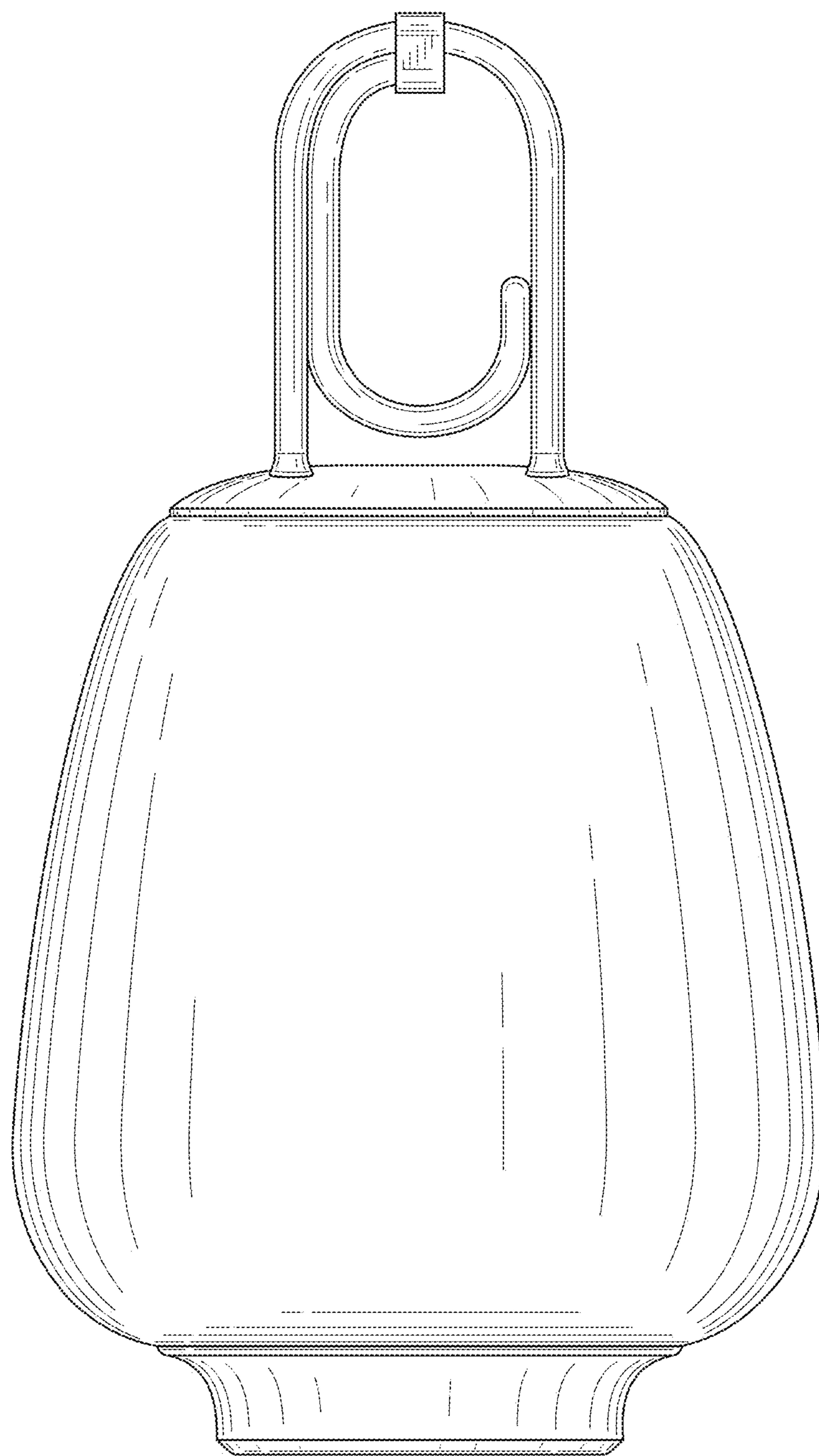

FIG. 2

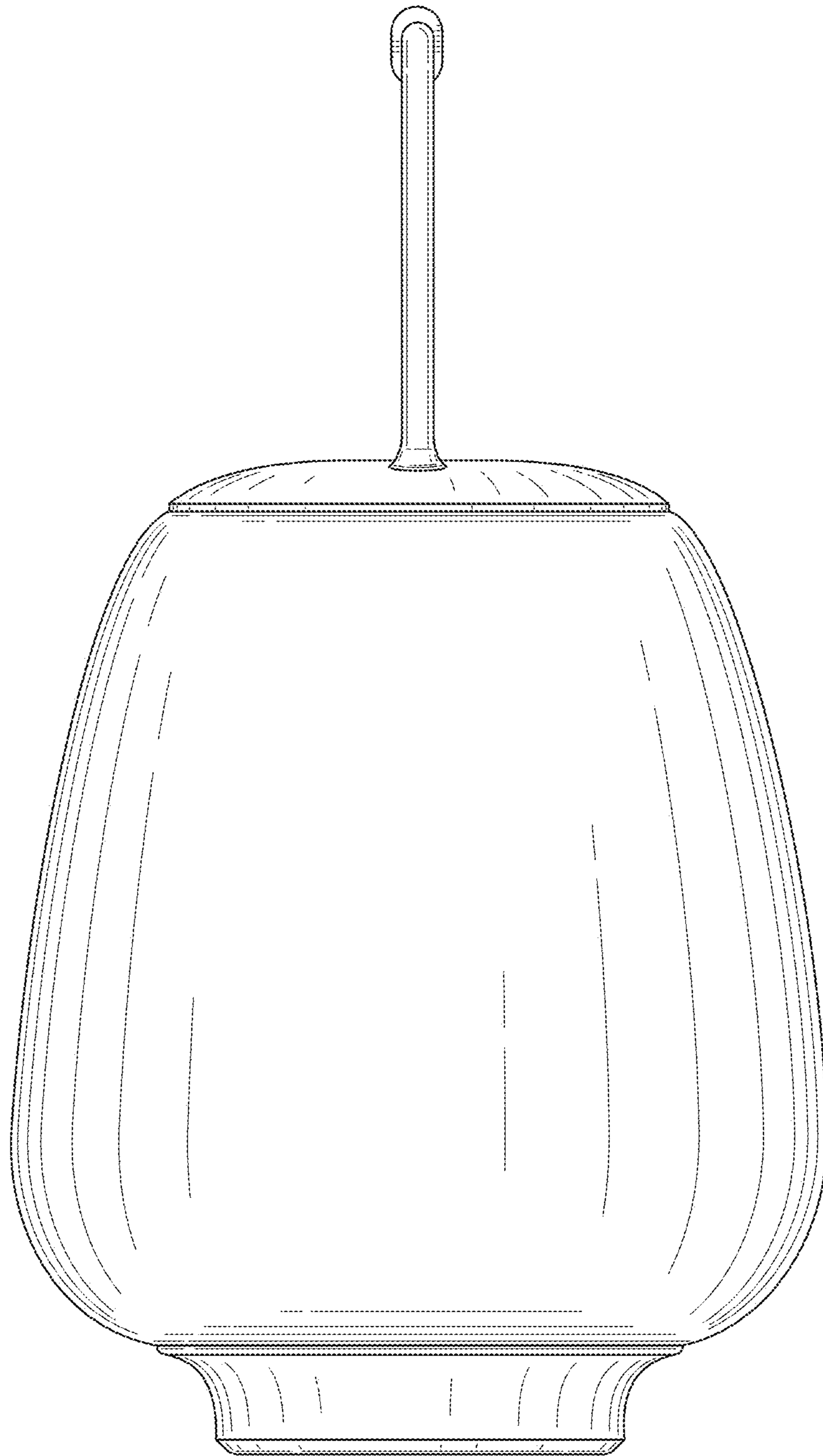

FIG. 3

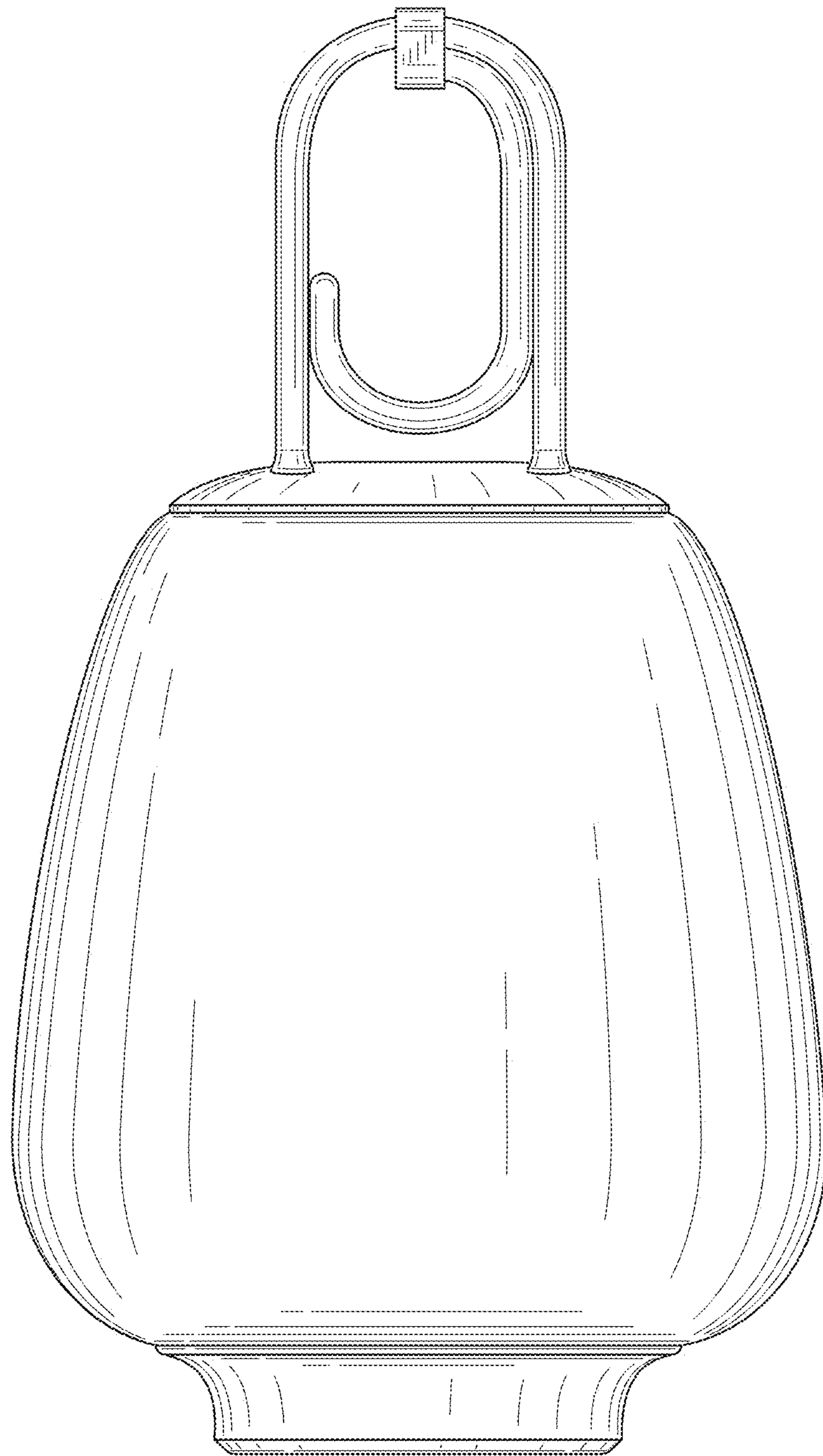

FIG. 4

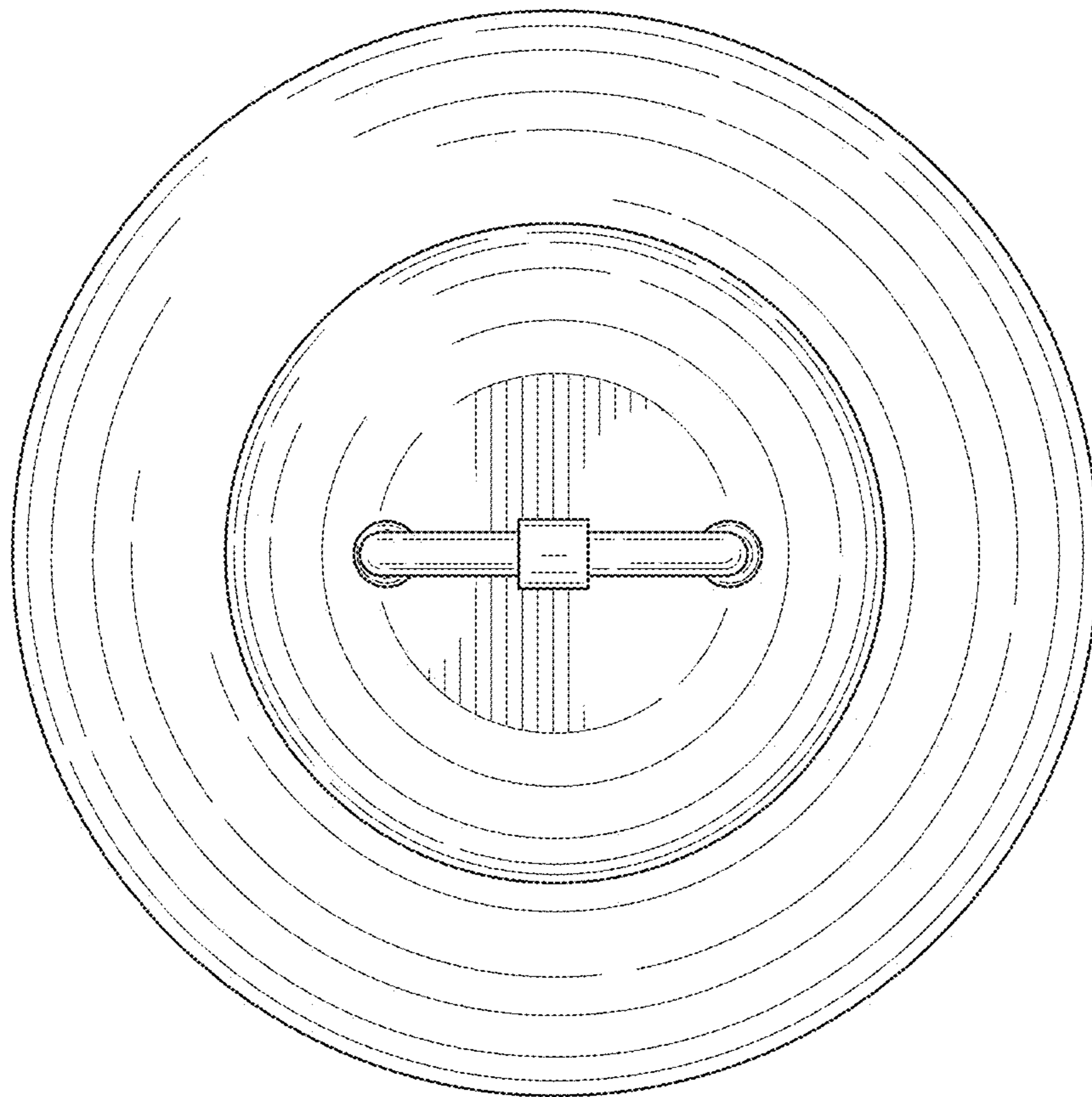

FIG. 5

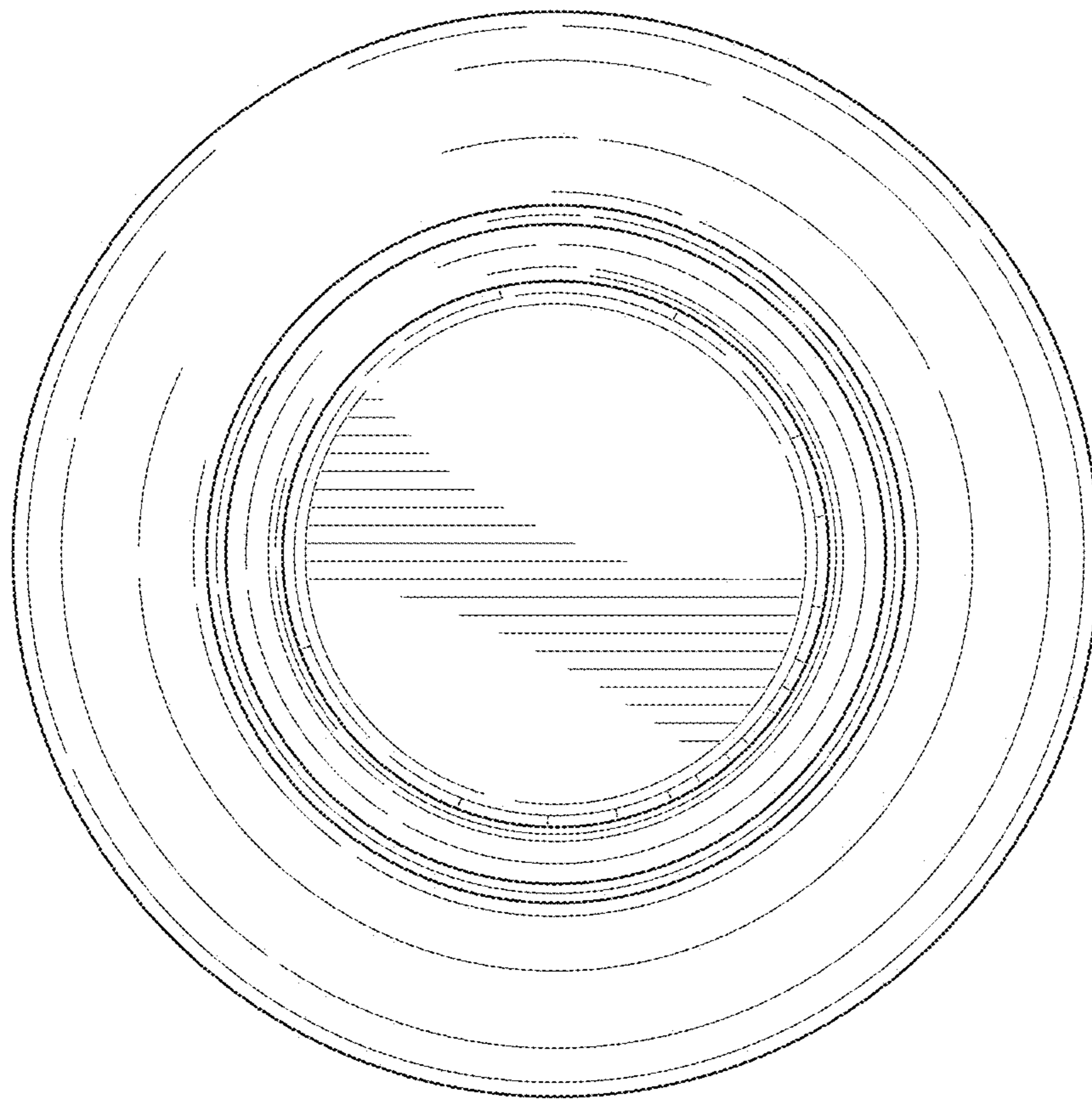

FIG. 6