

US00D949428S

(12) **United States Design Patent** (10) **Patent No.:** **US D949,428 S**
Sedic (45) **Date of Patent:** **** Apr. 19, 2022**

(54) **PERSONAL MASSAGER**
(71) Applicant: **Filip Sedic**, Stockholm (SE)
(72) Inventor: **Filip Sedic**, Stockholm (SE)
(73) Assignee: **LELO Inc.**, San Jose, CA (US)
(**) Term: **15 Years**
(21) Appl. No.: **29/779,820**
(22) Filed: **Apr. 21, 2021**

D857,224 S * 8/2019 Fuhner D24/215
D861,911 S * 10/2019 Fuhner D24/215
D875,267 S * 2/2020 Zeng D24/214
D879,990 S * 3/2020 Qiu D24/215
D879,992 S * 3/2020 Li D24/215
D882,109 S * 4/2020 Qiu D24/215
D884,206 S * 5/2020 Haddock D24/215
D884,914 S * 5/2020 Gao D24/215
D890,945 S * 7/2020 Lee D24/215
D890,946 S * 7/2020 Lee D24/215
D897,552 S * 9/2020 Meissner D24/215
D898,937 S * 10/2020 Haddock D24/215
D905,264 S * 12/2020 Tsang D24/215
D915,616 S * 4/2021 Lee D24/215

(Continued)

Related U.S. Application Data

(63) Continuation of application No. 29/706,282, filed on Sep. 19, 2019, now Pat. No. Des. 920,530.
(51) **LOC (13) Cl.** **28-03**
(52) **U.S. Cl.** **D24/215**
USPC **D24/215**
(58) **Field of Classification Search**
USPC D24/119, 133, 141, 188, 200, 211, 212, D24/213, 214, 215; D30/160
CPC A61H 2201/1628; A61H 2201/1645; A61H 19/44; A61H 19/50; A61H 19/40; A61H 19/34; A61H 2015/0042
See application file for complete search history.

OTHER PUBLICATIONS

Amazon, "ENIGMA Deep Rose", Oct. 29, 2021. <https://www.lelo.com/enigma>. Shown on p. 1. (Year: 2021).*

(Continued)

Primary Examiner — Michael A Maharajh
(74) *Attorney, Agent, or Firm* — Evan Feldstein

(57) **CLAIM**

I claim the ornamental design for a personal massager, as shown and described.

DESCRIPTION

FIG. 1 is a perspective view of a personal massager.
FIG. 2 is a left side view of the personal massager.
FIG. 3 is a right side view of the personal massager.
FIG. 4 is a rear view of the personal massager.
FIG. 5 is a front view of the personal massager.
FIG. 6 is a bottom view of the personal massager; and,
FIG. 7 is a top view of the personal massager.
The broken lines in the drawings are for the purpose of illustrating portions of the personal massager, which form no part of the claimed design.

1 Claim, 7 Drawing Sheets

(56) **References Cited**

U.S. PATENT DOCUMENTS

D681,219 S * 4/2013 Chen D24/215
D702,363 S * 4/2014 Tai D24/215
D712,054 S * 8/2014 Tai A61H 19/40
D795,446 S * 8/2017 Marshall D24/215
D796,054 S * 8/2017 Chen D24/215
D796,055 S * 8/2017 Chen D24/215
D825,073 S * 8/2018 Lenke D24/215
D836,792 S * 12/2018 Fuhner D24/215
D850,644 S * 6/2019 Sedic D24/215
D854,181 S * 7/2019 Wei D24/215

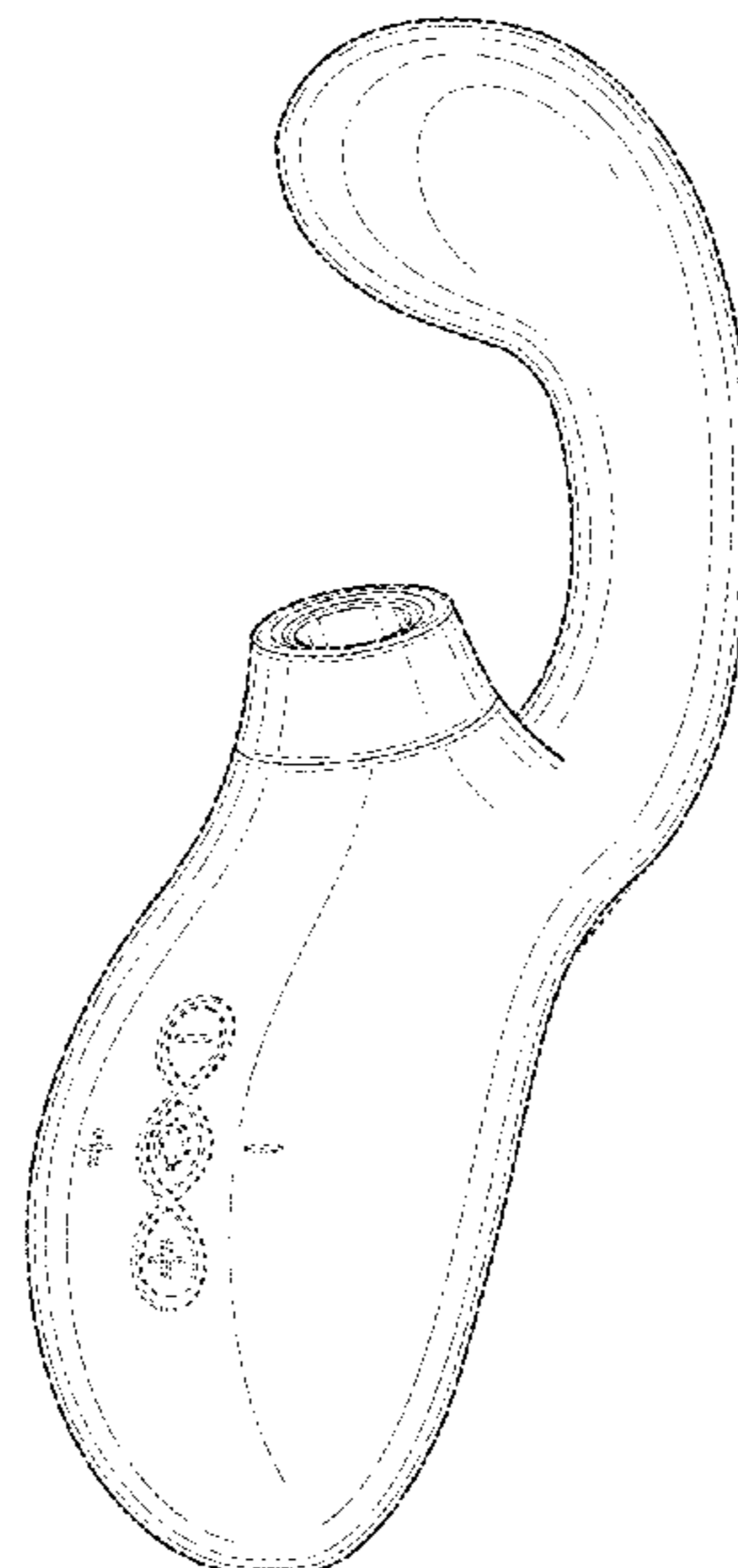

(56)

References Cited

U.S. PATENT DOCUMENTS

D917,062 S * 4/2021 Lee D24/215
D920,530 S * 5/2021 Sedic D24/215
11,007,113 B2 * 5/2021 Haddock A61H 23/02
2017/0027809 A1 * 2/2017 Lenke A61H 19/40
2017/0367926 A1 * 12/2017 Verreault G08C 23/04

OTHER PUBLICATIONS

Amazon, "LELO Enigma", Sep. 7, 2021. https://www.amazon.com/LELO-Stimulation-Massager-Waterproof-Vibrating/dp/B08XNHDT6D/ref=cm_cr_ar_p_d_pl_foot_top?ie=UTF8&th=1. Shown on p. 1. (Year: 2021).*

* cited by examiner

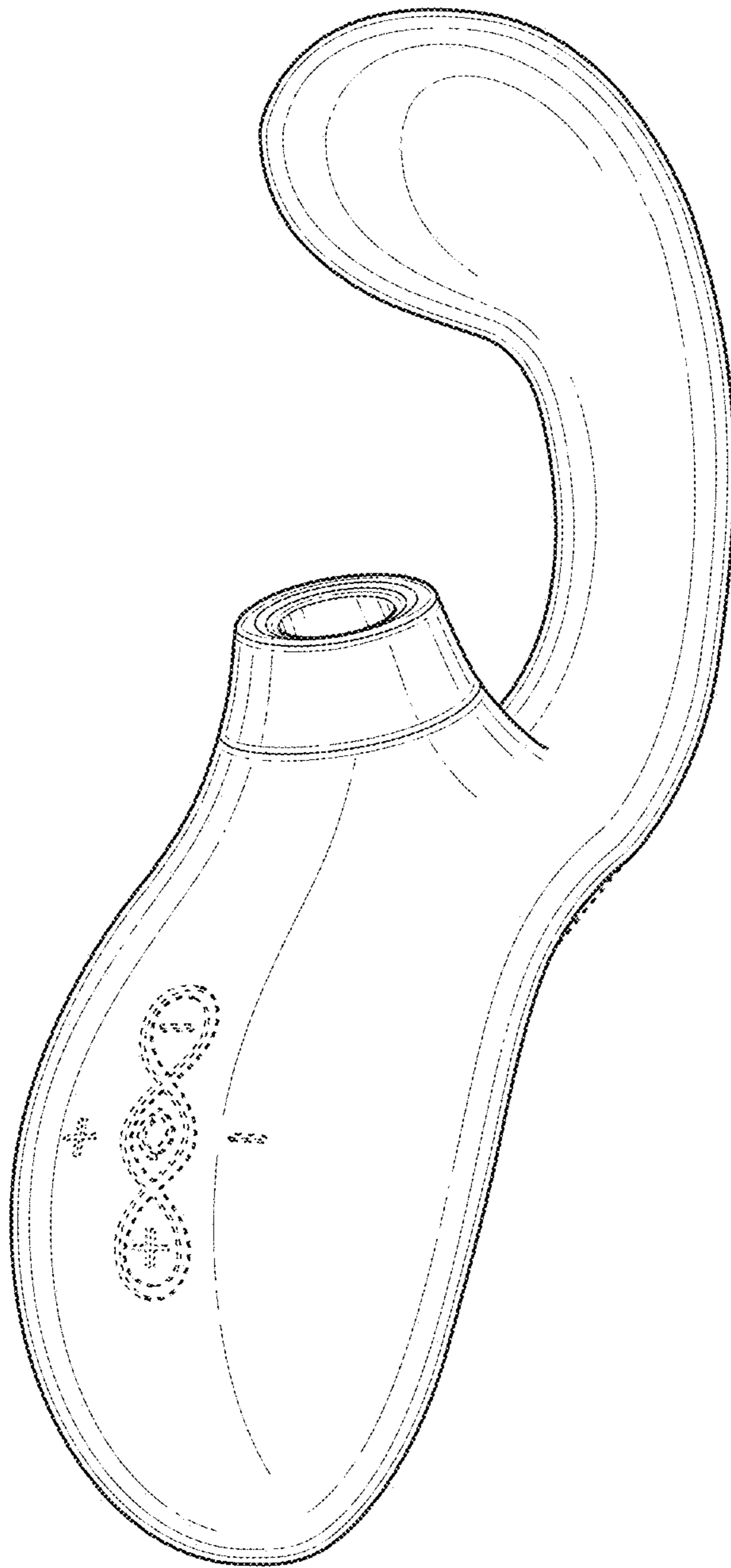

FIG. 1

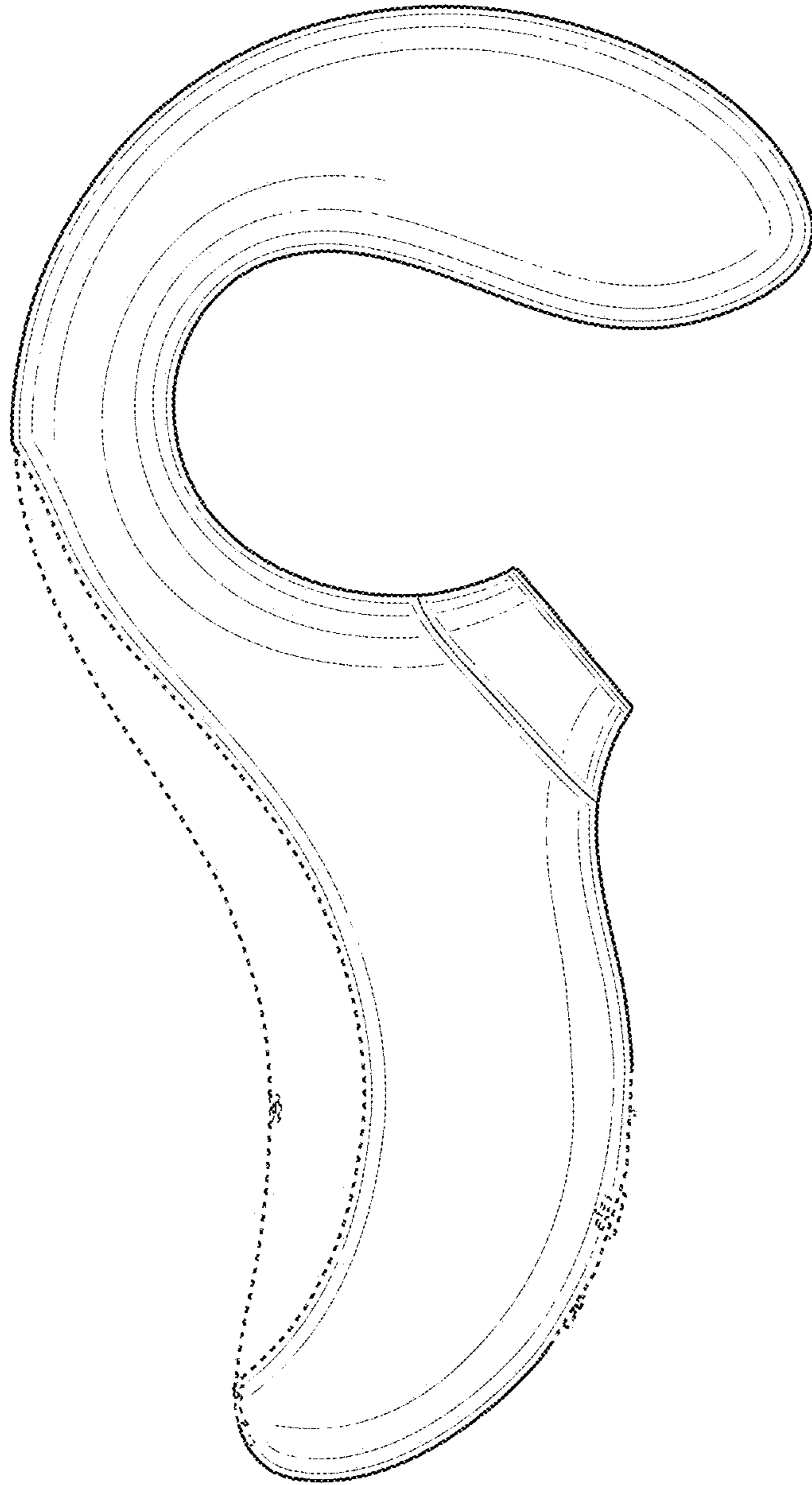

FIG. 2

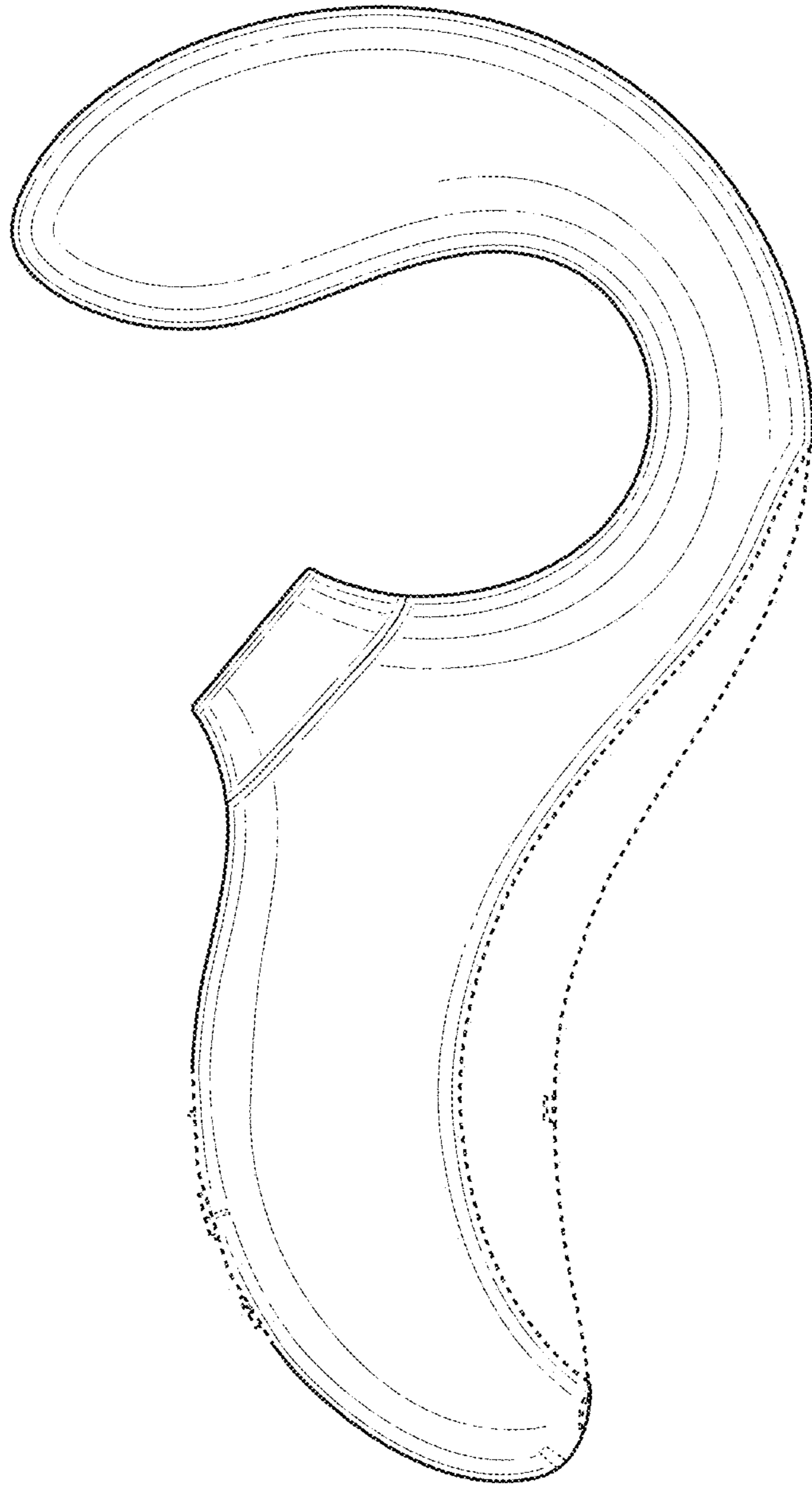

FIG. 3

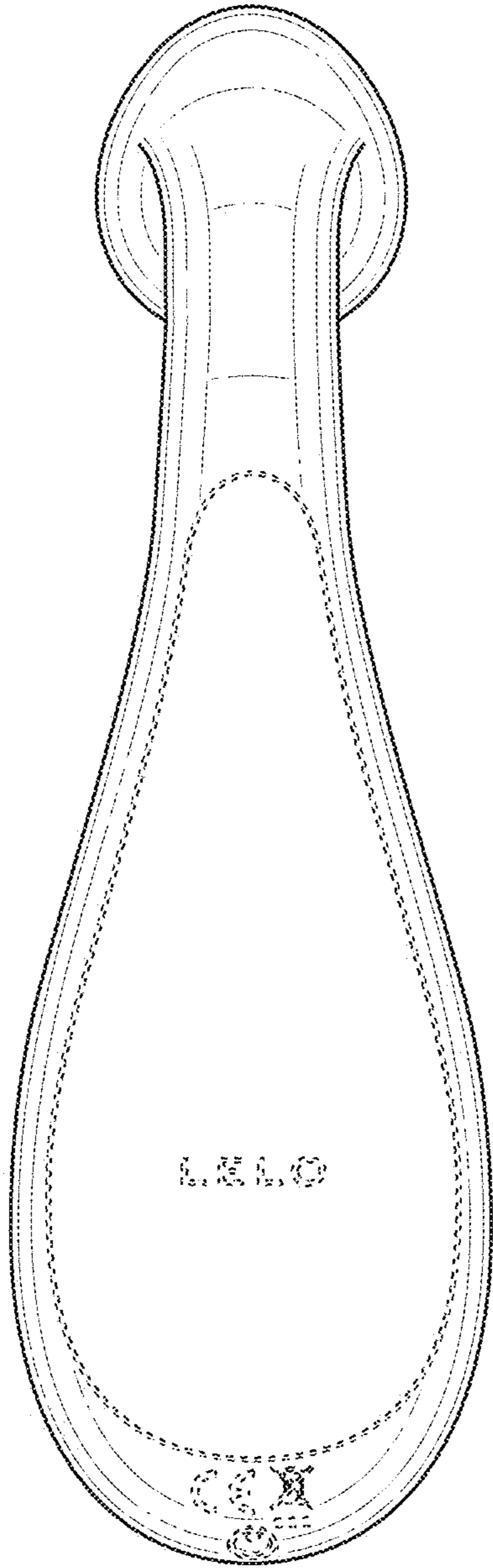

FIG. 4

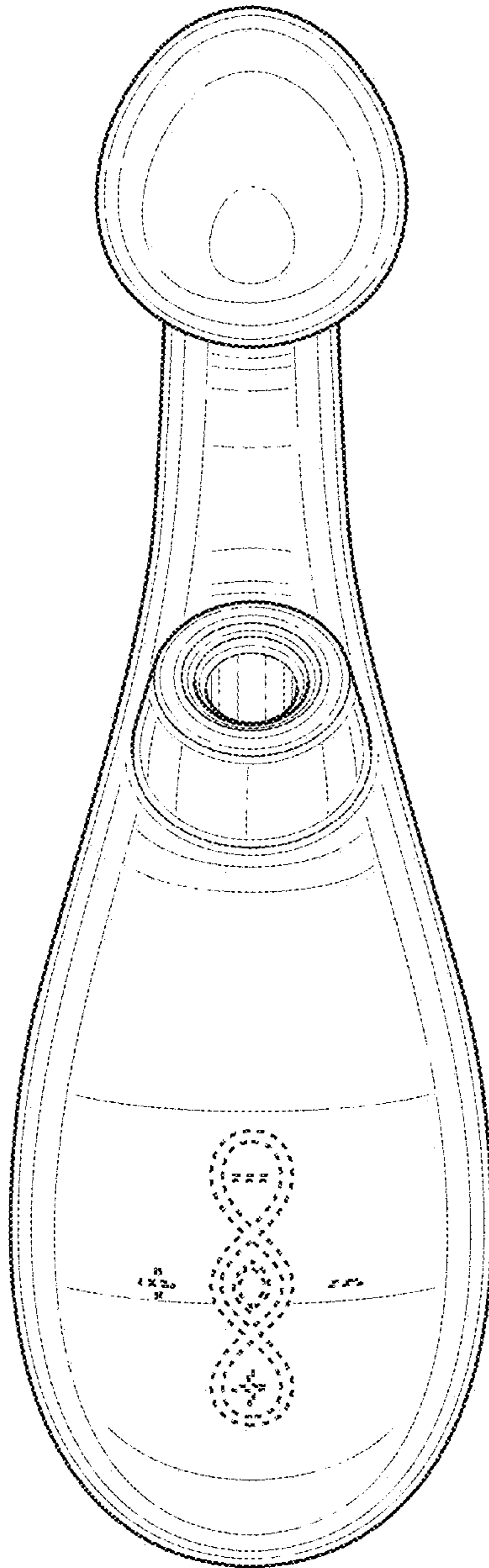

FIG. 5

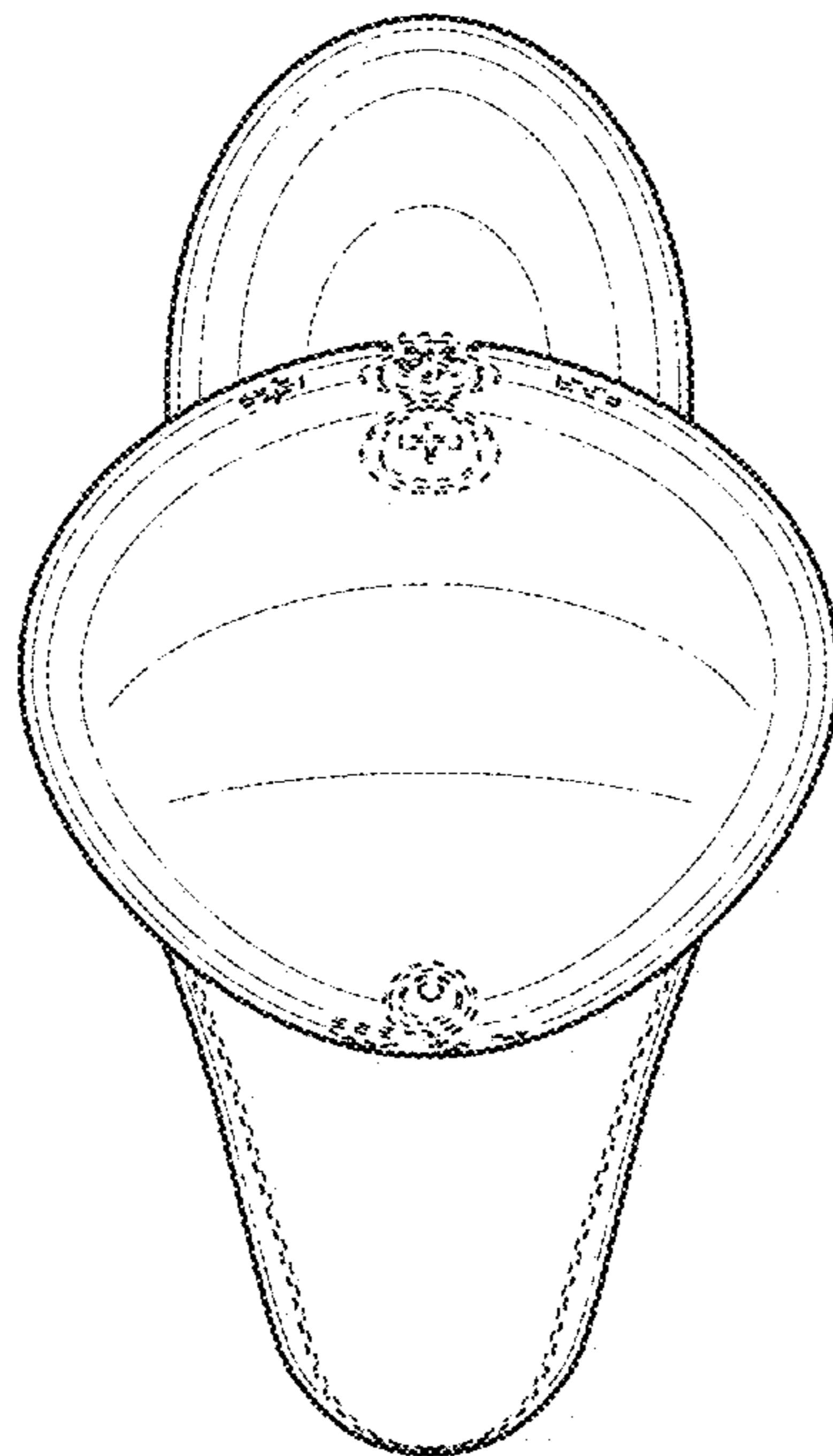

FIG. 6

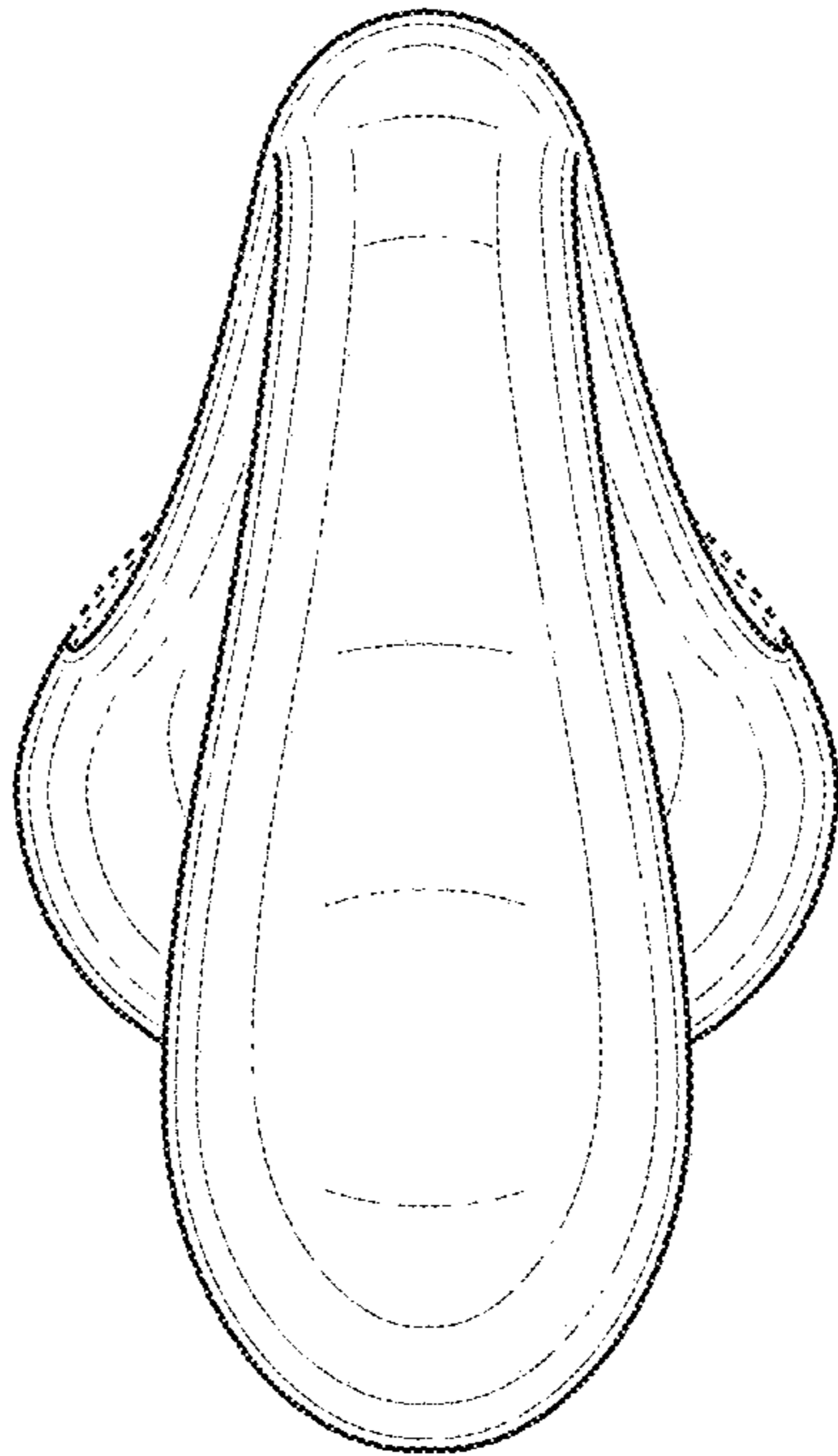

FIG. 7