

US00D949364S

(12) **United States Design Patent**
Carr

(10) **Patent No.:** **US D949,364 S**

(45) **Date of Patent:** **** Apr. 19, 2022**

(54) **MESSAGE TOOL**

(71) Applicant: **Daniel Edward Carr**, Los Angeles, CA
(US)

(72) Inventor: **Daniel Edward Carr**, Los Angeles, CA
(US)

(**) Term: **15 Years**

(21) Appl. No.: **29/727,934**

(22) Filed: **Mar. 13, 2020**

(51) **LOC (13) Cl.** **28-03**

(52) **U.S. Cl.**
USPC **D24/211**

(58) **Field of Classification Search**
USPC D24/200, 211, 212, 213, 214, 215;
D28/10, 13, 21; D30/160; D7/653, 693;
D32/40

CPC A61H 39/04; A61H 2205/021
See application file for complete search history.

(56) **References Cited**

U.S. PATENT DOCUMENTS

D418,942 S *	1/2000	Chen	D28/22
6,077,239 A *	6/2000	Lin	A61H 7/003 601/134
D434,183 S *	11/2000	Fraenkel	D28/22
D472,642 S *	4/2003	Henckel	D24/211
D524,445 S *	7/2006	Liang	D24/211
D542,926 S *	5/2007	Louis	D24/214
D574,110 S *	7/2008	Griffith	D28/21
D624,193 S *	9/2010	Katzenberger	D24/214
D634,022 S *	3/2011	Scappaticci	D24/215
D638,549 S *	5/2011	Scappaticci	D24/214
D645,568 S *	9/2011	Walker	D24/214
D683,862 S *	6/2013	Hartman	D24/214
D684,702 S *	6/2013	Cho	D24/215
D686,333 S *	7/2013	Innes	D24/215
D700,351 S *	2/2014	Kojima	D24/215

D712,056 S *	8/2014	Deramo	D24/215
D715,452 S *	10/2014	Schiavon	D24/200
RE45,657 E *	8/2015	Cho	D24/215
D752,238 S *	3/2016	Stock	D24/214
D752,239 S *	3/2016	Stock	D24/214
D753,317 S *	4/2016	Eddy	D24/214
D754,360 S *	4/2016	Stock	D24/214
D754,869 S *	4/2016	Stock	D24/214
D757,281 S *	5/2016	Hsieh	D24/200
D767,780 S *	9/2016	Pursel	D24/214
D788,934 S *	6/2017	Hirokawa	D24/215
D792,600 S *	7/2017	van den Dries	D24/215
D792,601 S *	7/2017	van den Dries	D24/215
D825,068 S *	8/2018	van den Dries	D24/200
D825,069 S *	8/2018	Capobianco	D24/200
D827,848 S *	9/2018	Iwagami	D24/215
D828,924 S *	9/2018	Maroney	D24/200
D828,926 S *	9/2018	Stock	D24/214
D834,212 S *	11/2018	Willis	D24/214
D834,720 S *	11/2018	Willis	D24/214
D850,642 S *	6/2019	Yokoyama	D24/215

(Continued)

Primary Examiner — Michael A Maharajh

(74) *Attorney, Agent, or Firm* — Cohen IP Law Group,
P.C.; Michael N. Cohen

(57) **CLAIM**

The ornamental design for a massage tool, as shown and described.

DESCRIPTION

FIG. 1: is a bottom perspective view of the massage tool showing my new design;
FIG. 2: is a top perspective view thereof;
FIG. 3: is a top plan view thereof;
FIG. 4: is a bottom plan view thereof;
FIG. 5: is a left side view thereof;
FIG. 6: is a right side view thereof;
FIG. 7: is a front view thereof; and,
FIG. 8: is a rear view thereof.

1 Claim, 8 Drawing Sheets

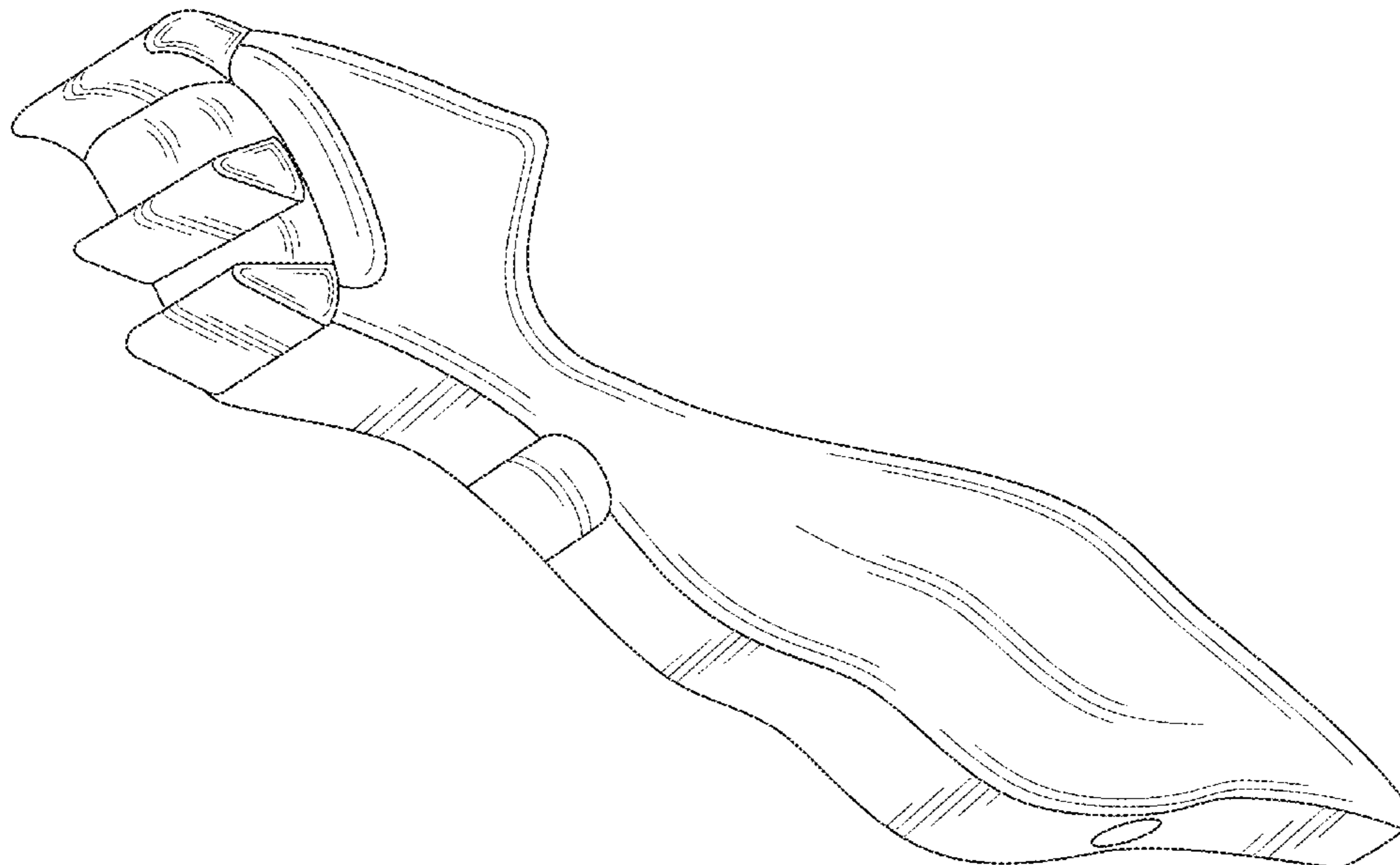

(56)

References Cited

U.S. PATENT DOCUMENTS

D858,788 S * 9/2019 Giddings A61H 7/007
D24/215
D861,185 S * 9/2019 Pihlavamaki D24/214
D863,585 S * 10/2019 Weitzner D24/214
D865,204 S * 10/2019 Matsushita D24/211
D865,988 S * 11/2019 Pudhnum D24/214
D866,781 S * 11/2019 Maroney D24/200
D874,060 S * 1/2020 Galekovic D28/21
D882,808 S * 4/2020 Miller D24/215
D890,940 S * 7/2020 Shin D24/200
D894,417 S * 8/2020 Paterson D24/214
D894,418 S * 8/2020 Paterson D24/214
D895,131 S * 9/2020 Liu D24/214
D897,036 S * 9/2020 Alejandro D28/21
D903,884 S * 12/2020 Rollins D24/200
D904,638 S * 12/2020 Shiota D24/215
D908,900 S * 1/2021 Rollins D24/200
D908,905 S * 1/2021 Braden D24/215
D908,906 S * 1/2021 Braden D24/215
D910,867 S * 2/2021 Kaminski, Jr. D24/214
D912,262 S * 3/2021 Rubinshteyn D24/214
2014/0213944 A1 * 7/2014 Kojima A61H 7/007
601/137
2014/0213945 A1 * 7/2014 Kojima A61H 39/04
601/137
2017/0340509 A1 * 11/2017 van den Dries B32B 3/266
2020/0060918 A1 * 2/2020 Bezkor A61H 1/008

* cited by examiner

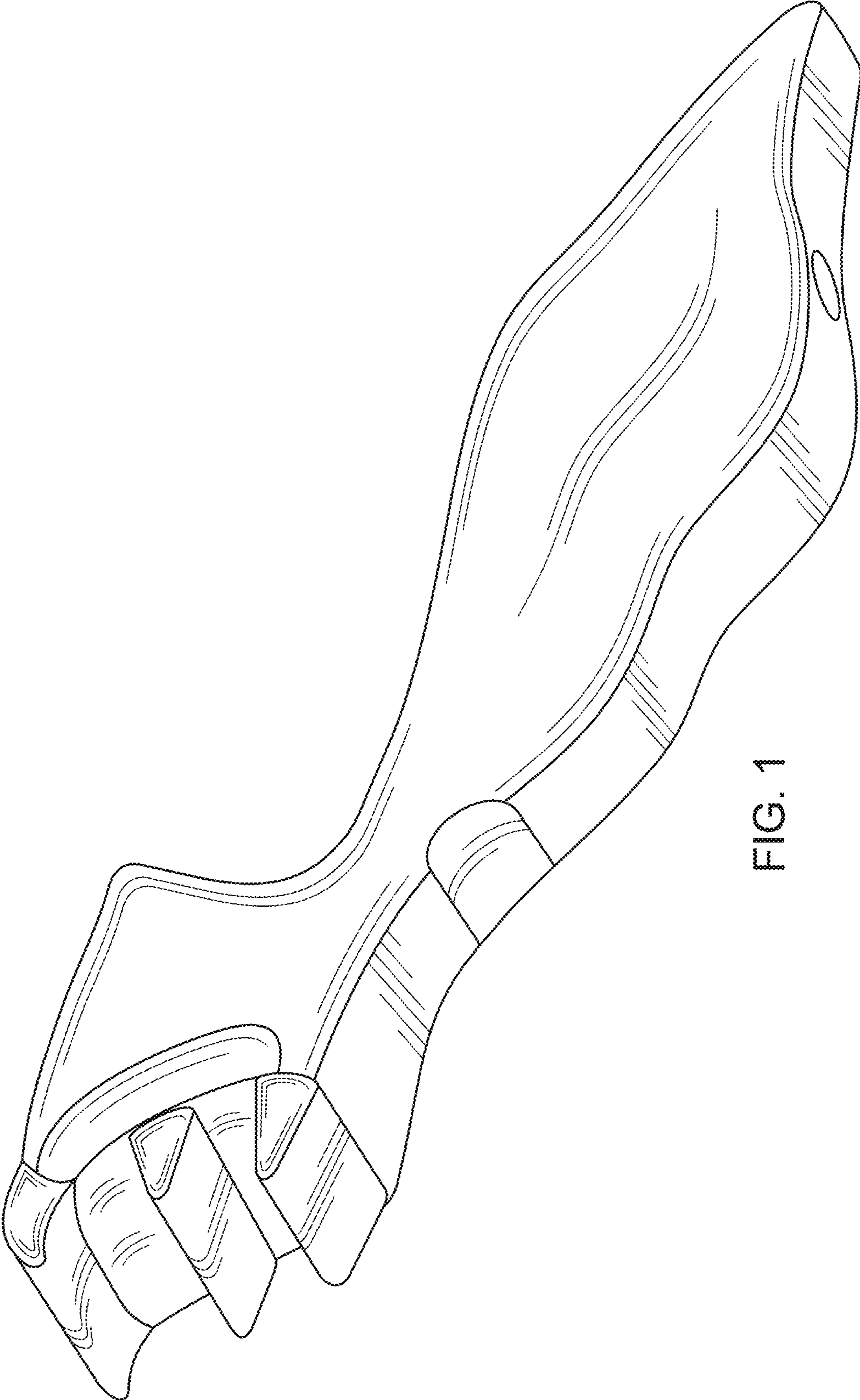

FIG. 1

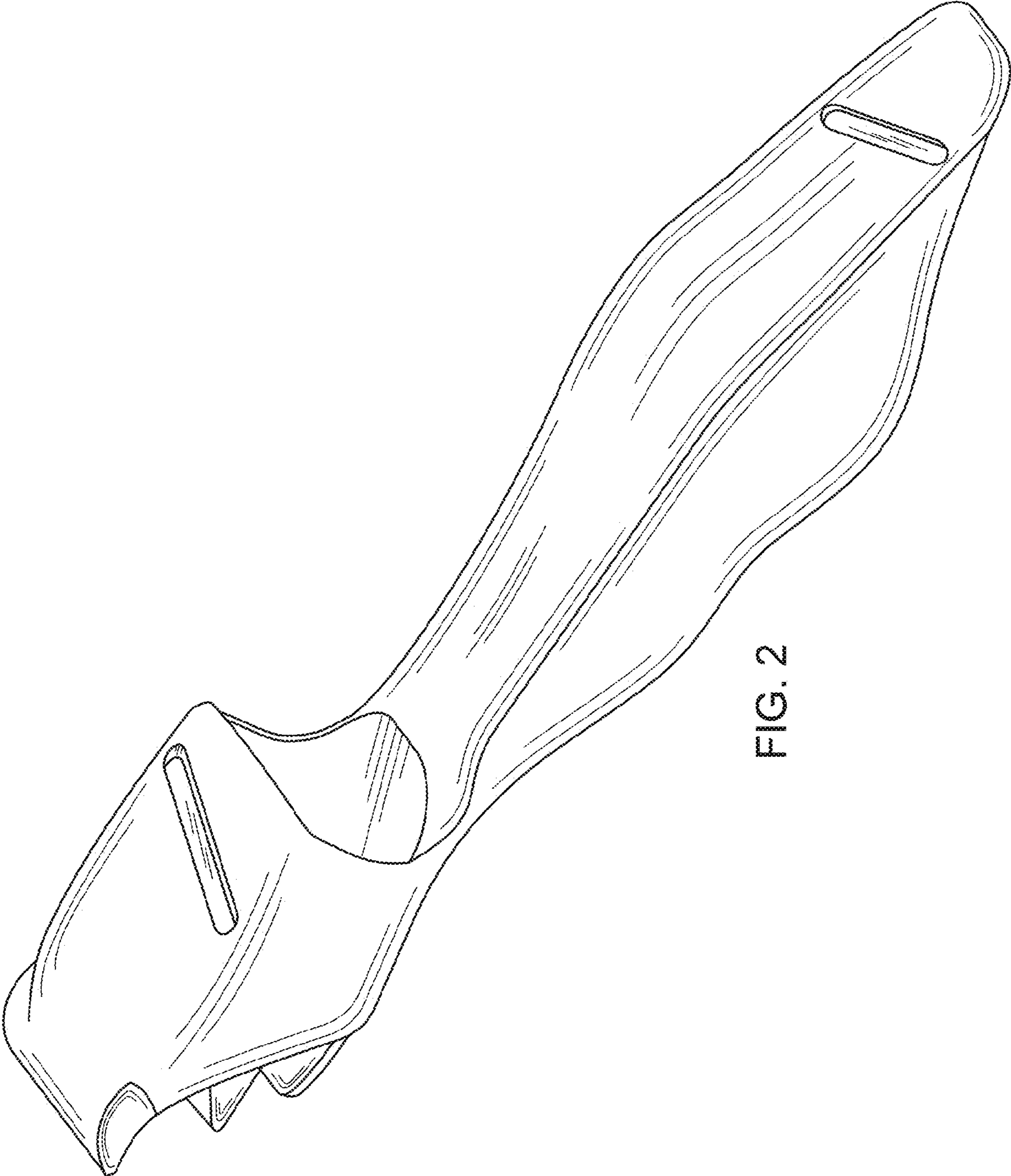

FIG. 2

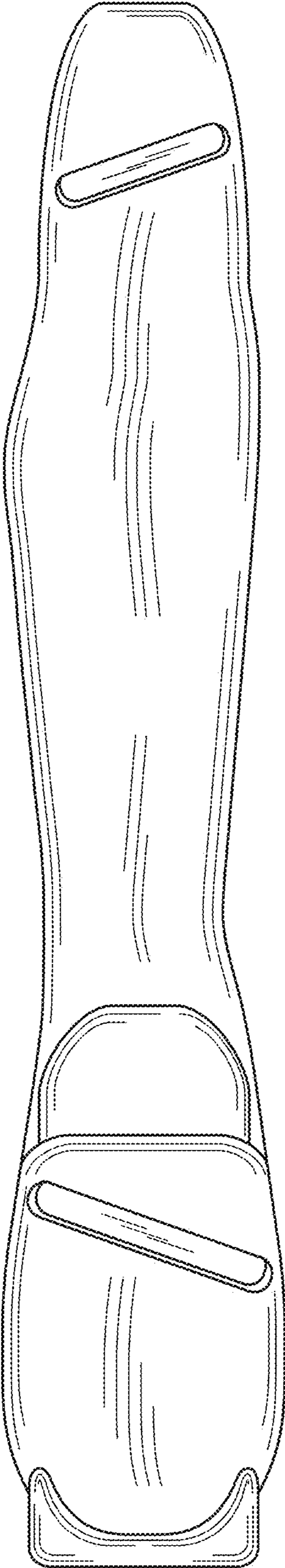

FIG. 3

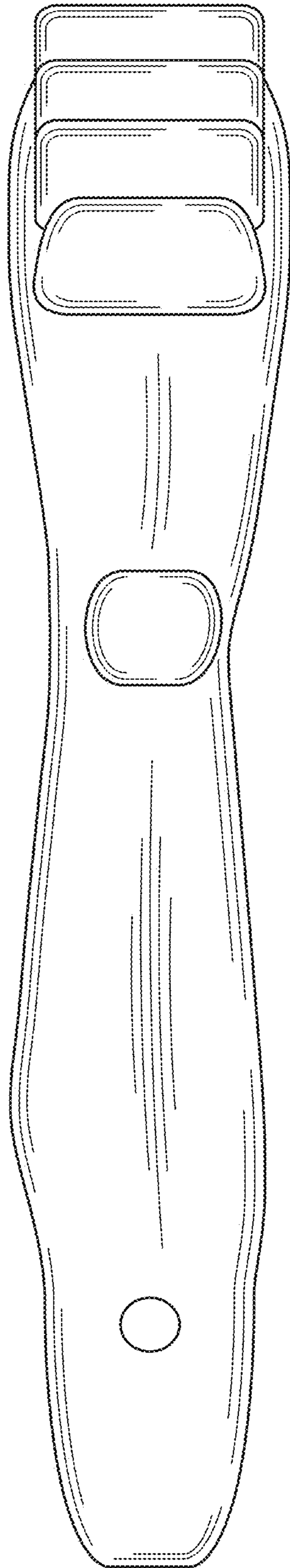

FIG. 4

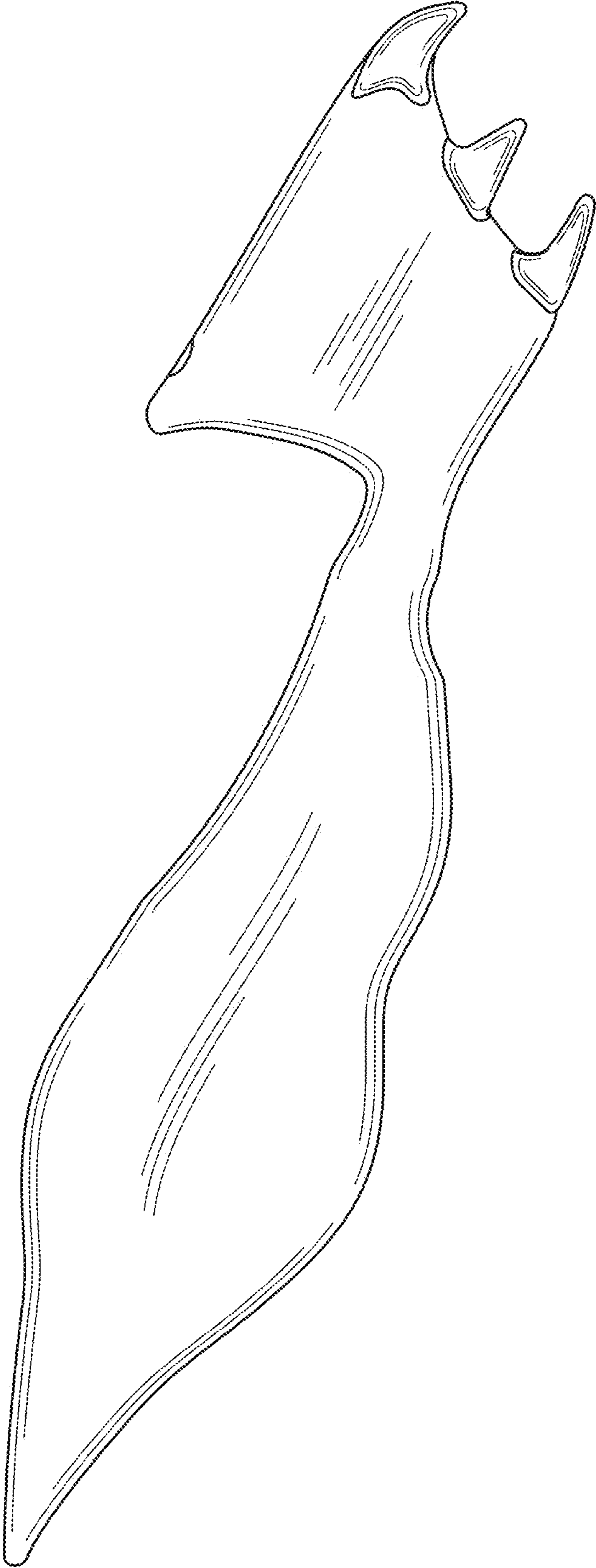

FIG. 5

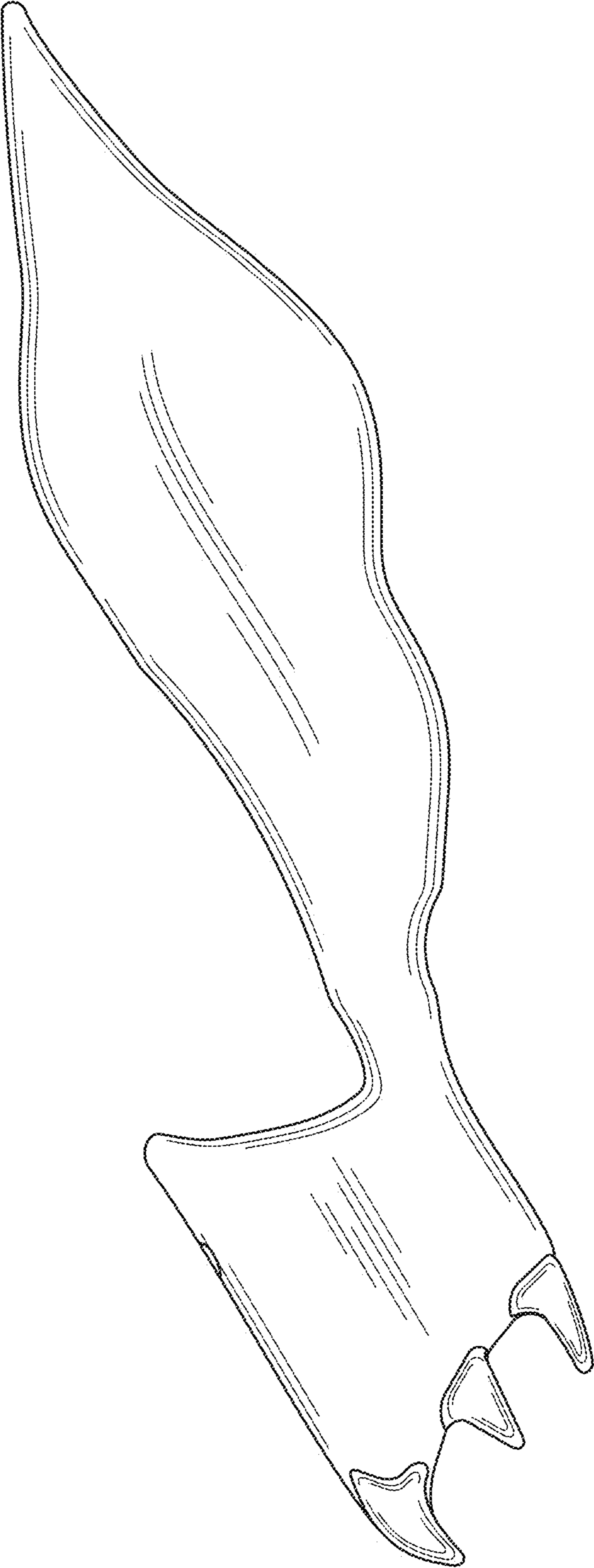

FIG. 6

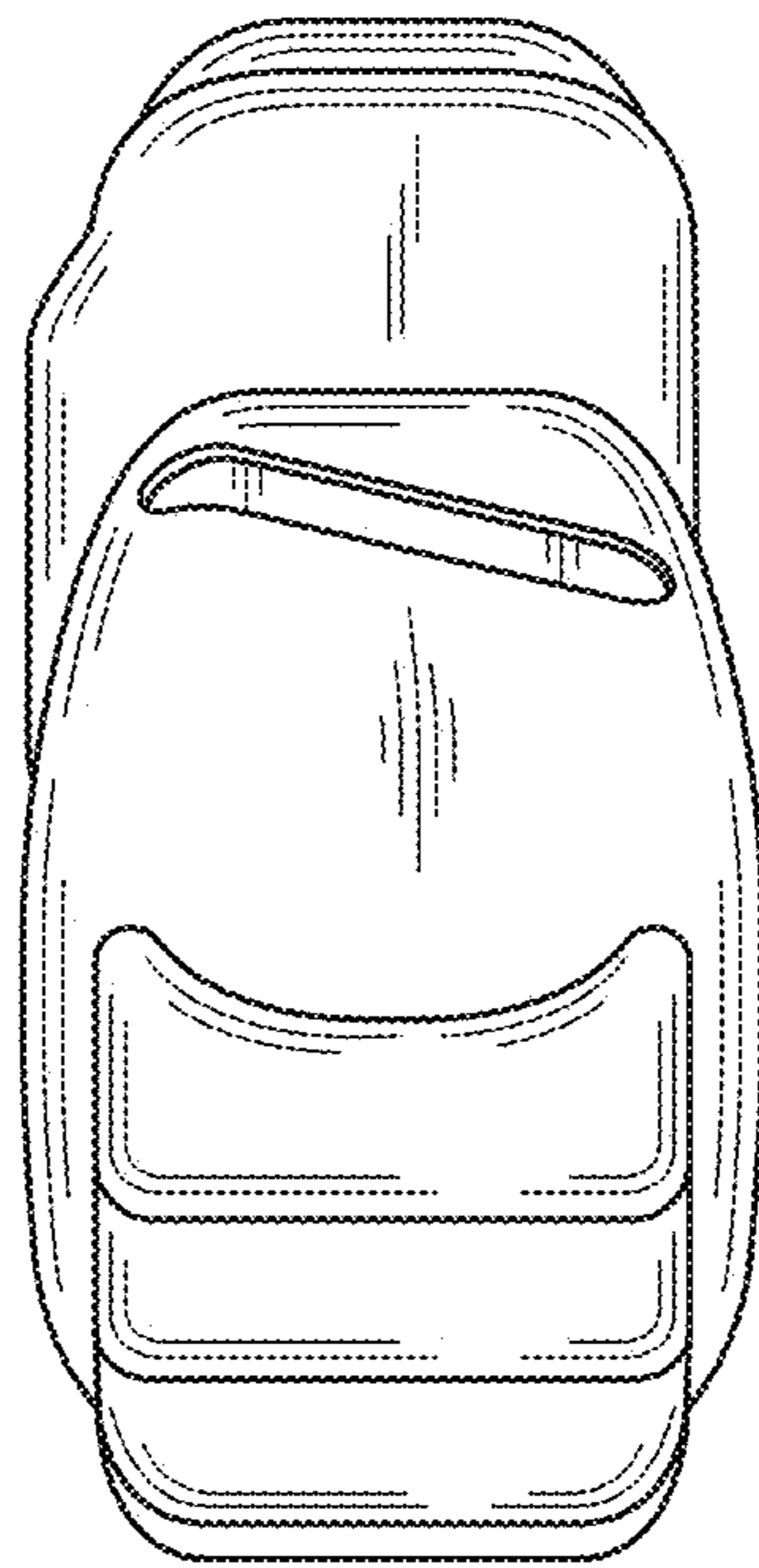

FIG. 7

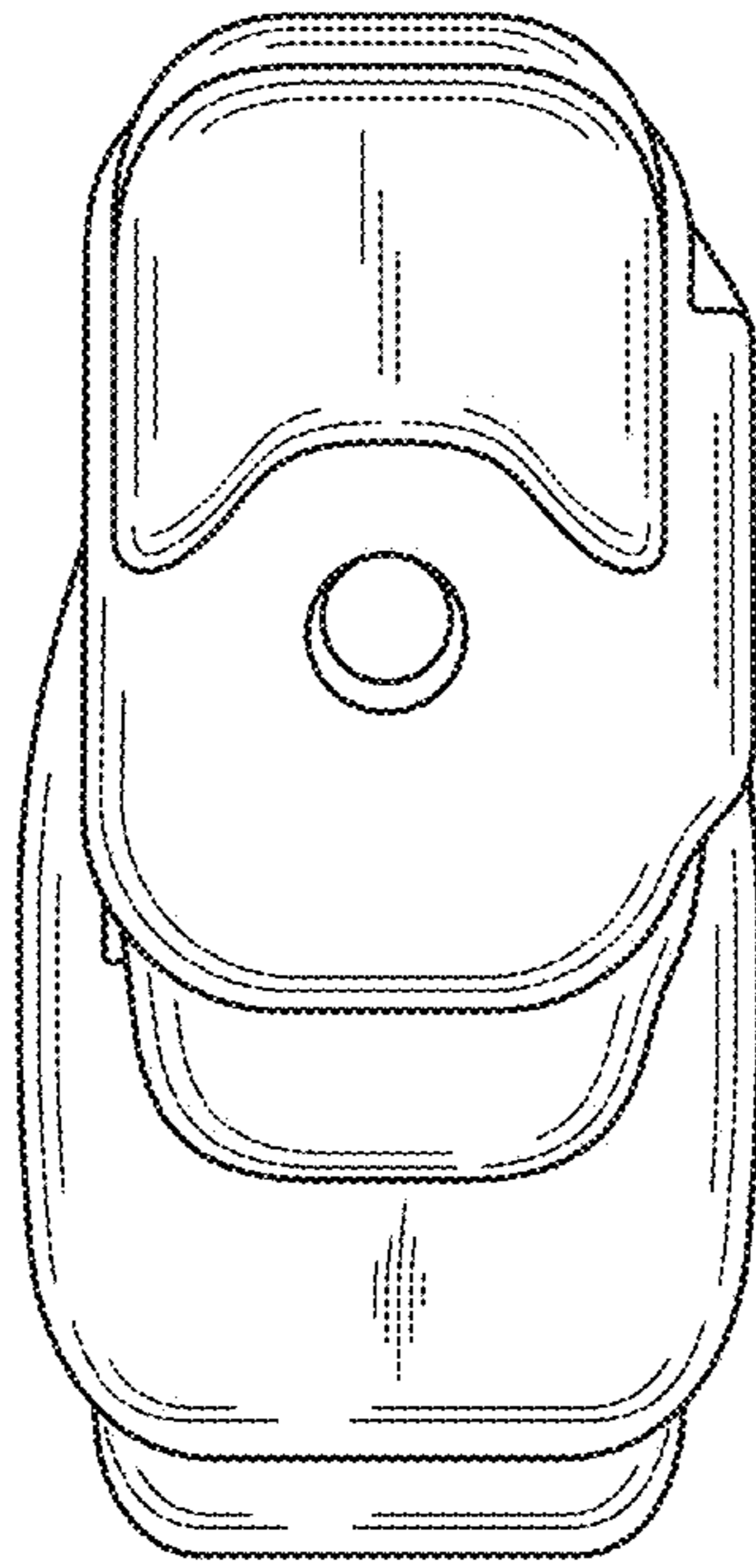

FIG. 8