



US00D949360S

(12) **United States Design Patent** (10) **Patent No.:** **US D949,360 S**  
**Lombardo et al.** (45) **Date of Patent:** **\*\* Apr. 19, 2022**

(54) **ROLLER DEVICE**

(71) Applicant: **Church & Dwight Co., Inc.**, Princeton, NJ (US)

(72) Inventors: **LoriAnn Lombardo**, East Hanover, NJ (US); **Aaron Szymanski**, Thomaston, CT (US)

(73) Assignee: **Church & Dwight Co., Inc.**, Princeton, NJ (US)

(\*\*) Term: **15 Years**

(21) Appl. No.: **29/706,193**

(22) Filed: **Sep. 18, 2019**

(51) **LOC (13) Cl.** ..... **28-03**

(52) **U.S. Cl.**  
USPC ..... **D24/211**

(58) **Field of Classification Search**  
USPC ..... D24/200, 211, 212, 213, 214, 215;  
D4/122

(Continued)

(56) **References Cited**

**U.S. PATENT DOCUMENTS**

622,350 A 4/1899 Hans  
926,245 A 6/1909 Coon

(Continued)

**FOREIGN PATENT DOCUMENTS**

AT 55/1994-0001 2/1994  
AU 125274 5/1945

(Continued)

**OTHER PUBLICATIONS**

Amazon, "Finishing Touch Flawless Facial Massager", Oct. 3, 2020. [https://www.amazon.com/Finishing-Touch-Flawless-Facial-Massage/dp/B08DXVZ6QP/ref=cm\\_cr\\_ar\\_p\\_d\\_product\\_top?ie=UTF8](https://www.amazon.com/Finishing-Touch-Flawless-Facial-Massage/dp/B08DXVZ6QP/ref=cm_cr_ar_p_d_product_top?ie=UTF8). Shwon on p. 1. (Year: 2020).\*

(Continued)

*Primary Examiner* — Cynthia Ramirez

*Assistant Examiner* — Michael A Maharajh

(74) *Attorney, Agent, or Firm* — Womble Bond Dickinson (US) LLP

(57) **CLAIM**

The ornamental design for a roller device, as shown and described.

**DESCRIPTION**

FIG. 1 is a front perspective view of a first embodiment of a roller device showing our new design;

FIG. 2 is a front view of the roller device;

FIG. 3 is a back view of the roller device;

FIG. 4 is a side view of the roller device;

FIG. 5 is another side view of the roller device;

FIG. 6 is another side view of the roller device;

FIG. 7 is another side view of the roller device;

FIG. 8 is a top plan view of the roller device;

FIG. 9 is a bottom plan view of the roller device;

FIG. 10 is a front perspective view of a second embodiment of a roller device;

FIG. 11 is a front view of the roller device;

FIG. 12 is a back view of the roller device;

FIG. 13 is a side view of the roller device;

FIG. 14 is another side view of the roller device;

FIG. 15 is another side view of the roller device;

FIG. 16 is another side view of the roller device;

FIG. 17 is a top plan view of the roller device;

FIG. 18 is a bottom plan view of the roller device;

FIG. 19 is a front perspective view of a third embodiment of a roller device;

FIG. 20 is a front view of the roller device;

FIG. 21 is a back view of the roller device;

FIG. 22 is a side view of the roller device;

FIG. 23 is another side view of the roller device;

FIG. 24 is another side view of the roller device;

FIG. 25 is another view of the roller device;

FIG. 26 is a top plan view of the roller device;

FIG. 27 is a bottom plan view of the roller device;

FIG. 28 is a front perspective view of a fourth embodiment of a roller device;

FIG. 29 is a front view of the roller device;

(Continued)



FIG. 30 is a back view of the roller device;  
 FIG. 31 is a side view of the roller device;  
 FIG. 32 is another side view of the roller device;  
 FIG. 33 is another side view of the roller device;  
 FIG. 34 is another side view of the roller device;  
 FIG. 35 is a top plan view of the roller device; and,  
 FIG. 36 is a bottom plan view of the roller device.  
 The particles shown in the handle of the roller device are movable and transition based upon the position of the device. The broken lines in the drawings are for the purpose of illustrating portions of the roller device, which form no part of the claimed design.

1 Claim, 32 Drawing Sheets

D863,580	S	*	10/2019	Lee	.....	D24/211
D863,581	S	*	10/2019	Lee	.....	D24/211
D865,201	S	*	10/2019	Gaquiere	.....	D24/211
D865,202	S	*	10/2019	Gaquiere	.....	D24/211
D865,203	S	*	10/2019	Eschbach	.....	D24/211
D865,293	S	*	10/2019	Adams	.....	D28/58
D890,941	S	*	7/2020	Gaquiere	.....	D24/211
D895,823	S	*	9/2020	Khubani	.....	D24/211
2005/0187498	A1		8/2005	Miller		
2011/0125067	A1*		5/2011	Filho	.....	A61H 15/0092 601/19
2012/0109041	A1		5/2012	Munz		
2013/0048011	A1*		2/2013	Bickford	.....	A45D 40/28 132/320
2015/0057579	A1		2/2015	Martinez		
2015/0374409	A1*		12/2015	Chopdat	.....	A61B 17/54 606/131

(58) **Field of Classification Search**  
 CPC ..... A61H 15/00; A61H 2015/0014; A61H  
 15/0092  
 See application file for complete search history.

(56) **References Cited**  
 U.S. PATENT DOCUMENTS

1,270,635	A		6/1918	Ljungstrom		
1,744,423	A		1/1930	Toadvine		
1,923,317	A		8/1933	Lipsner		
1,947,042	A		2/1934	Gennan		
2,057,396	A		10/1936	Seidel		
D114,731	S	*	5/1939	Tresenberg	.....	D24/211
2,472,385	A		6/1949	Rollman		
2,787,261	A		4/1957	McDonald et al.		
D206,258	S	*	11/1966	Roth	.....	D4/122
4,813,404	A		3/1989	Vallis		
4,884,560	A		12/1989	Kuracina		
D306,524	S	*	3/1990	Marshall	.....	D4/122
5,127,395	A		7/1992	Bontemps		
5,152,281	A		10/1992	Koll		
D336,163	S	*	6/1993	Chien-Min	.....	D4/122
5,267,399	A		12/1993	Johnston		
D352,130	S	*	11/1994	Zierhut	.....	401/208
5,666,963	A		9/1997	Swenson et al.		
D385,060	S	*	10/1997	Burrell	.....	D28/7
D414,875	S		10/1999	Sirois et al.		
6,648,904	B2		11/2003	Altshuler et al.		
D483,571	S	*	12/2003	Khubani	.....	D4/122
D498,397	S	*	11/2004	Mitchell	.....	D8/14
D549,834	S	*	8/2007	Huang	.....	D24/211
7,481,783	B1		1/2009	Kelley		
D661,168	S	*	6/2012	Furling	.....	D8/51
D661,491	S	*	6/2012	Bunnag	.....	D4/122
D671,747	S	*	12/2012	Guyton	.....	D4/122
D671,748	S	*	12/2012	Guyton	.....	D4/122
D676,975	S	*	2/2013	Bickford	.....	D24/211
D677,391	S	*	3/2013	Bickford	.....	D24/211
D677,392	S	*	3/2013	Bickford	.....	D24/211
D678,540	S	*	3/2013	Bickford	.....	D24/211
D678,541	S	*	3/2013	Bickford	.....	D24/211
D678,542	S	*	3/2013	Bickford	.....	D24/211
D690,944	S	*	10/2013	Lee	.....	D4/122
D706,981	S	*	6/2014	Clough	.....	D28/44.1
D781,498	S	*	3/2017	Pel	.....	D28/58
D781,499	S	*	3/2017	Pel	.....	D28/58
D820,522	S	*	6/2018	Colin	.....	D28/58
D824,596	S	*	7/2018	Gobber	.....	A45D 29/00 D28/58
D829,919	S	*	10/2018	Davis	.....	D24/211
D841,176	S	*	2/2019	Gaquiere	.....	D24/211
D849,259	S	*	5/2019	Gaquiere	.....	D24/211

FOREIGN PATENT DOCUMENTS

CA			2101825			2/1995
CN			2061052			8/1990
CN			2236303			10/1996
CN			2239494			11/1996
CN			2272286			1/1998
CN			2278466			4/1998
CN			2292552			9/1998
CN			2413685			1/2001
CN			1454584			11/2003
CN			300779815			5/2008
CN			302002689			7/2012
CN			302002753			7/2012
CN			203073458			7/2013
CN			302562252			9/2013
CN			302621013			10/2013
CN			302727467			1/2014
CN			203436539			2/2014
CN			303084499			1/2015
CN			303171515			4/2015
CN			303781867			8/2016
CN			303798174			8/2016
CN			304147157			5/2017
CN			304433868			12/2017
CN			304510814			2/2018
CN			304977058			1/2019
DE			345284			12/1921
DE			M9305491-0001			4/1994
EM			001322069-000			4/2012
EM			004068971-000			7/2017
EP			0667138			8/1995
EP			1797847			6/2007
EP			2493350			5/2015
GB			191201630			10/1912
GB			2036141			4/1994
GB			2036347			6/1994
GB			2036348			6/1994
GB			2538219			11/2016
JP			H07106216			11/1995
JP			H1033609			2/1998
JP			D1485808			12/2013
JP			D1600550			3/2018
KR			300267784.0000			10/2000
KR			2020000020252			11/2000
KR			200243032			10/2001
KR			300710897.0000			10/2013
KR			300829518.0000			12/2015
KR			300979290.0000			11/2018

OTHER PUBLICATIONS

Flawlessbeauty, "Flawless Ice Roller", Dec. 14, 2020. <https://www.flawlessbeauty.com/ICE.dtm>. Shown on p. 1. (Year: 2020).\*

\* cited by examiner





**FIG. 1**

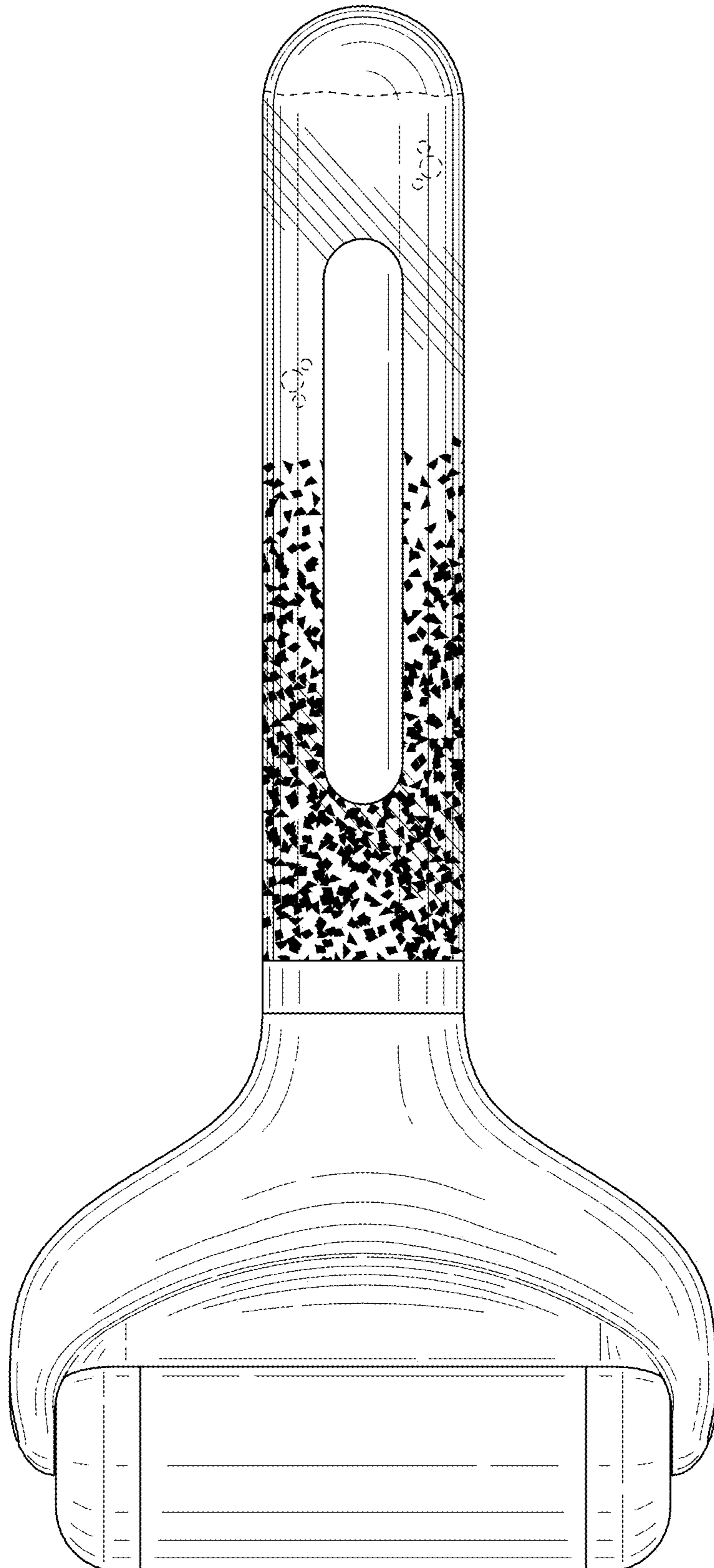
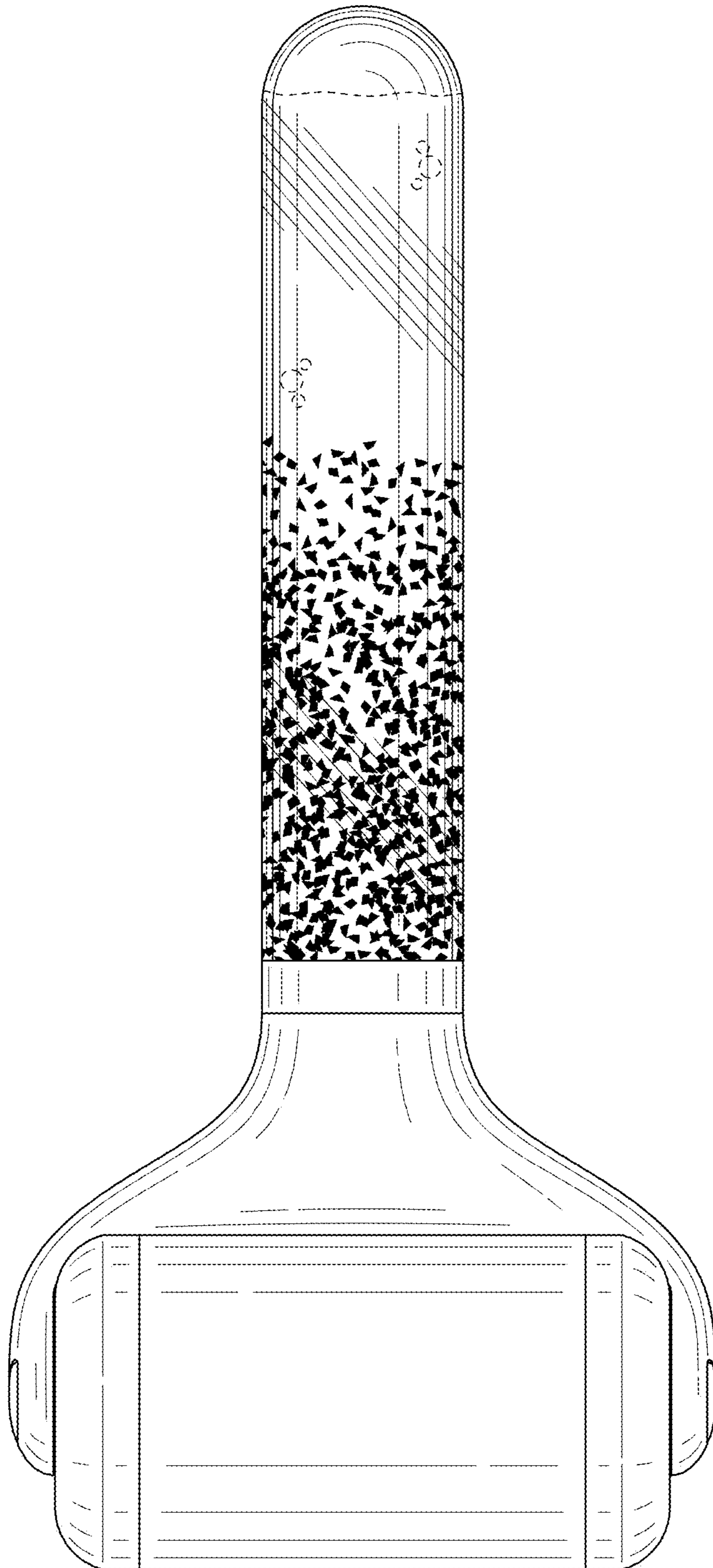


FIG. 2



**FIG. 3**

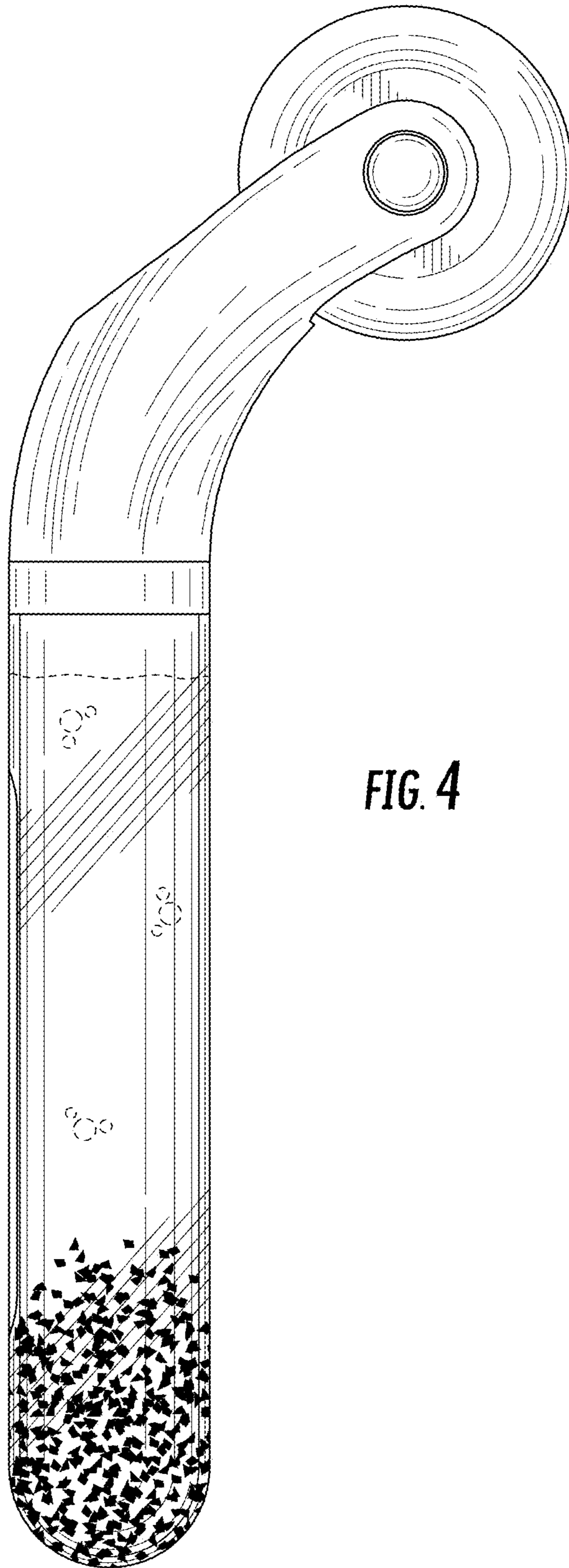


FIG. 4



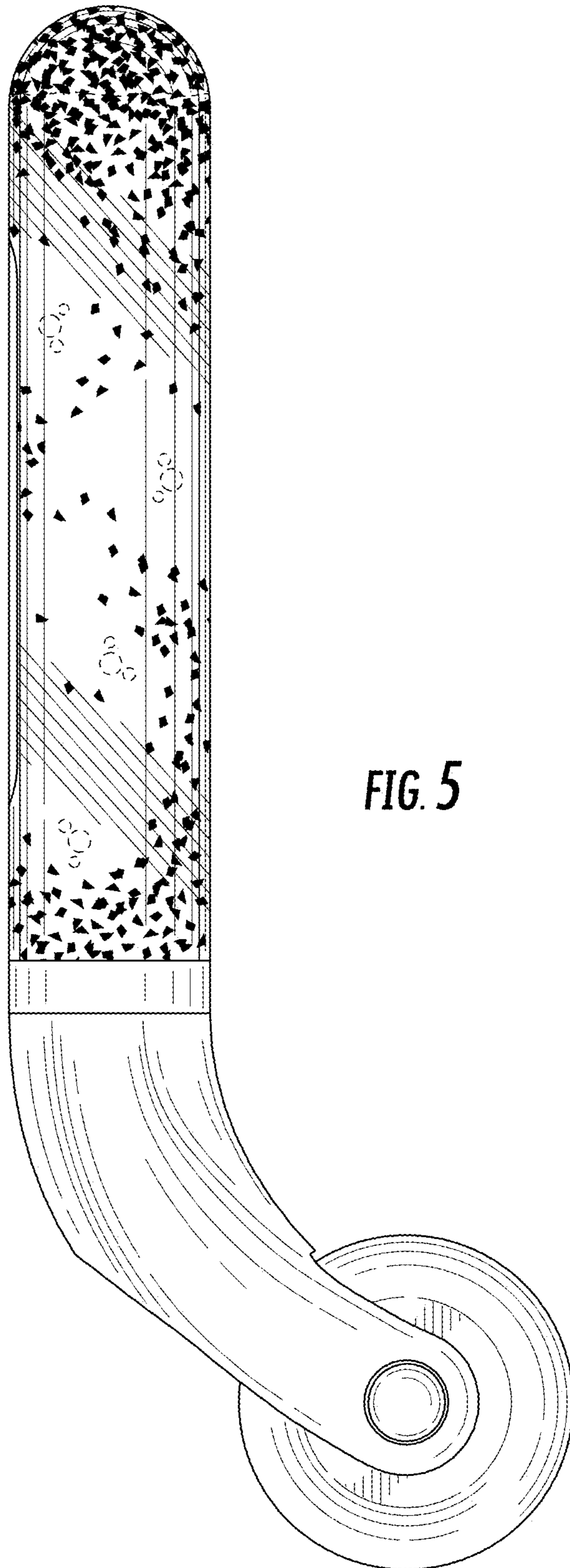


FIG. 5

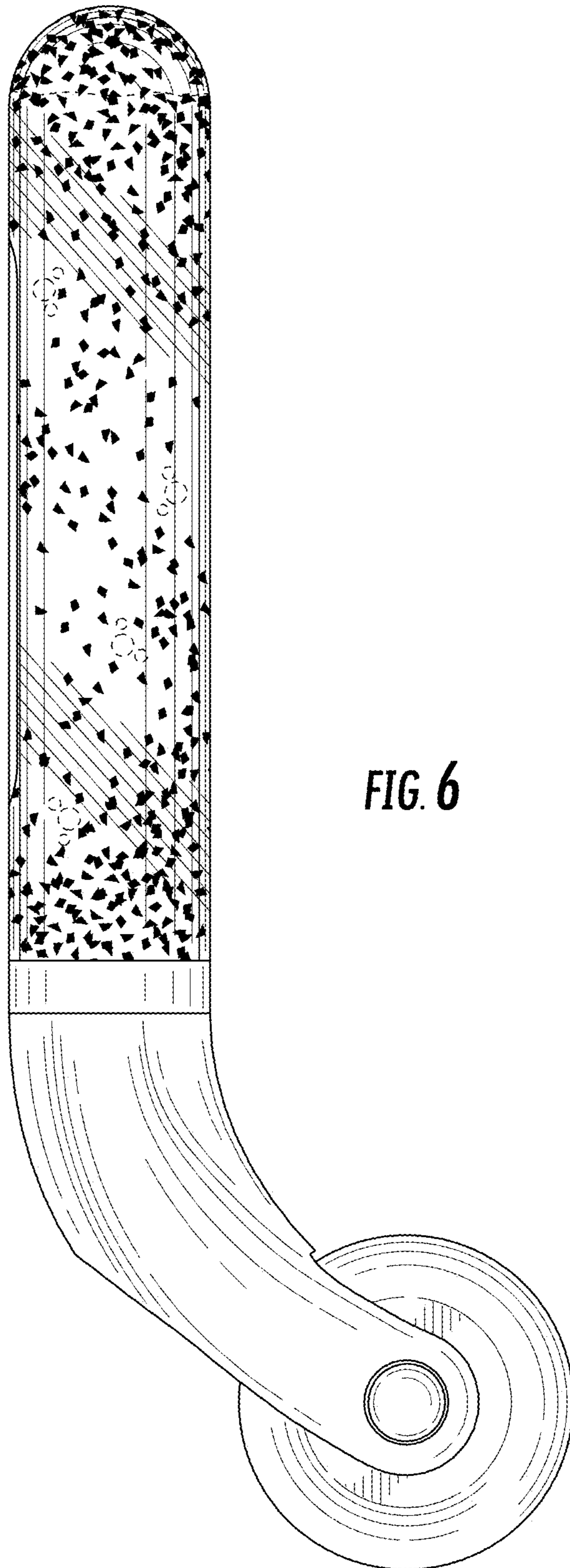


FIG. 6



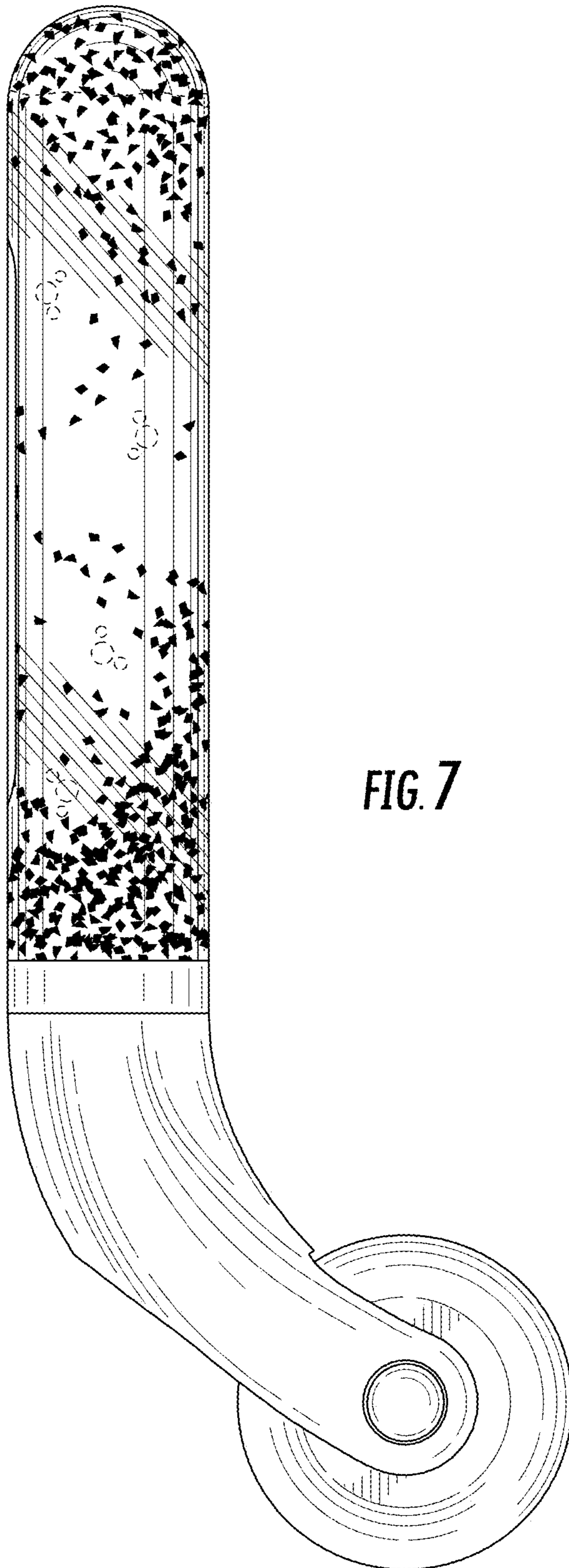


FIG. 7

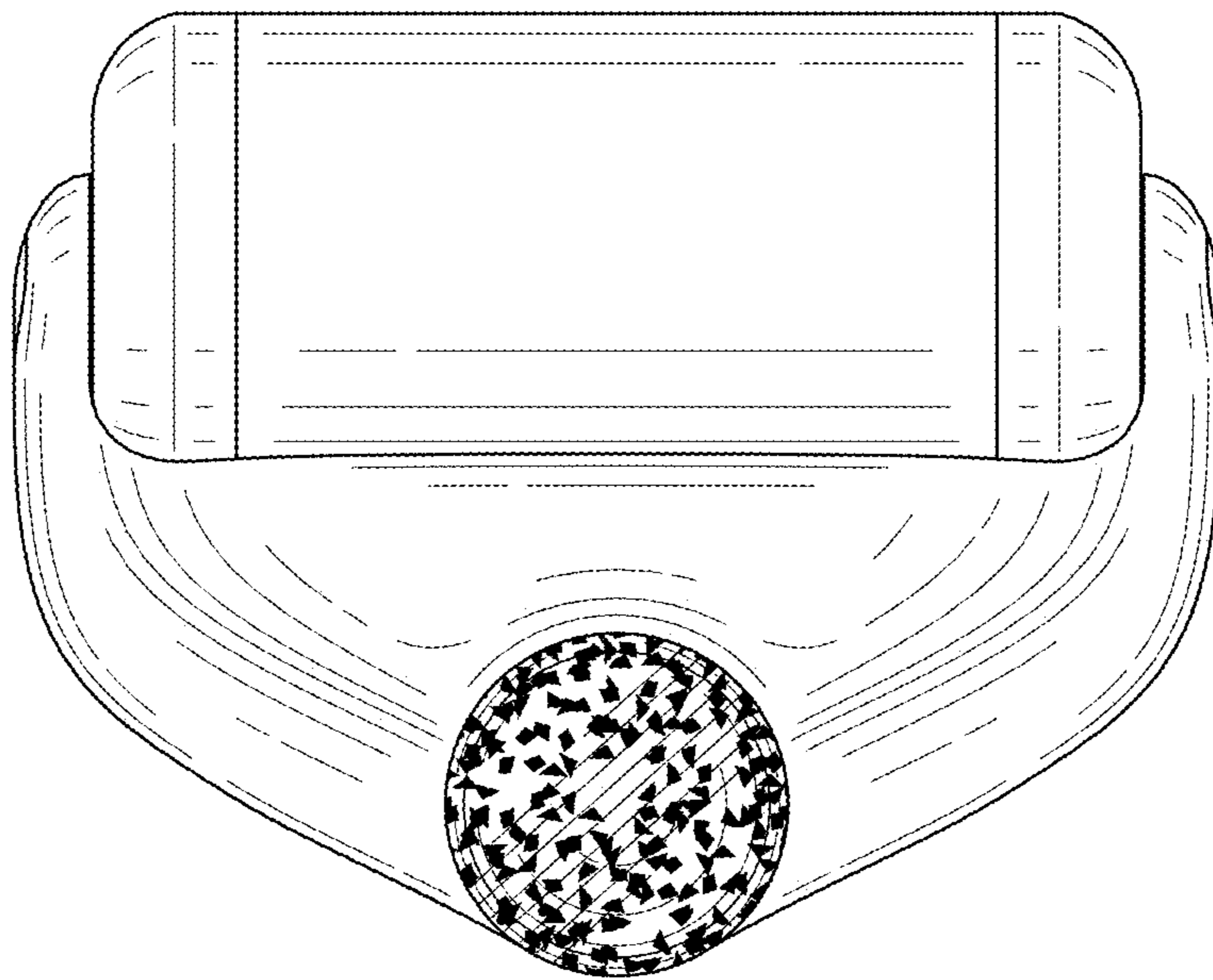


FIG. 8

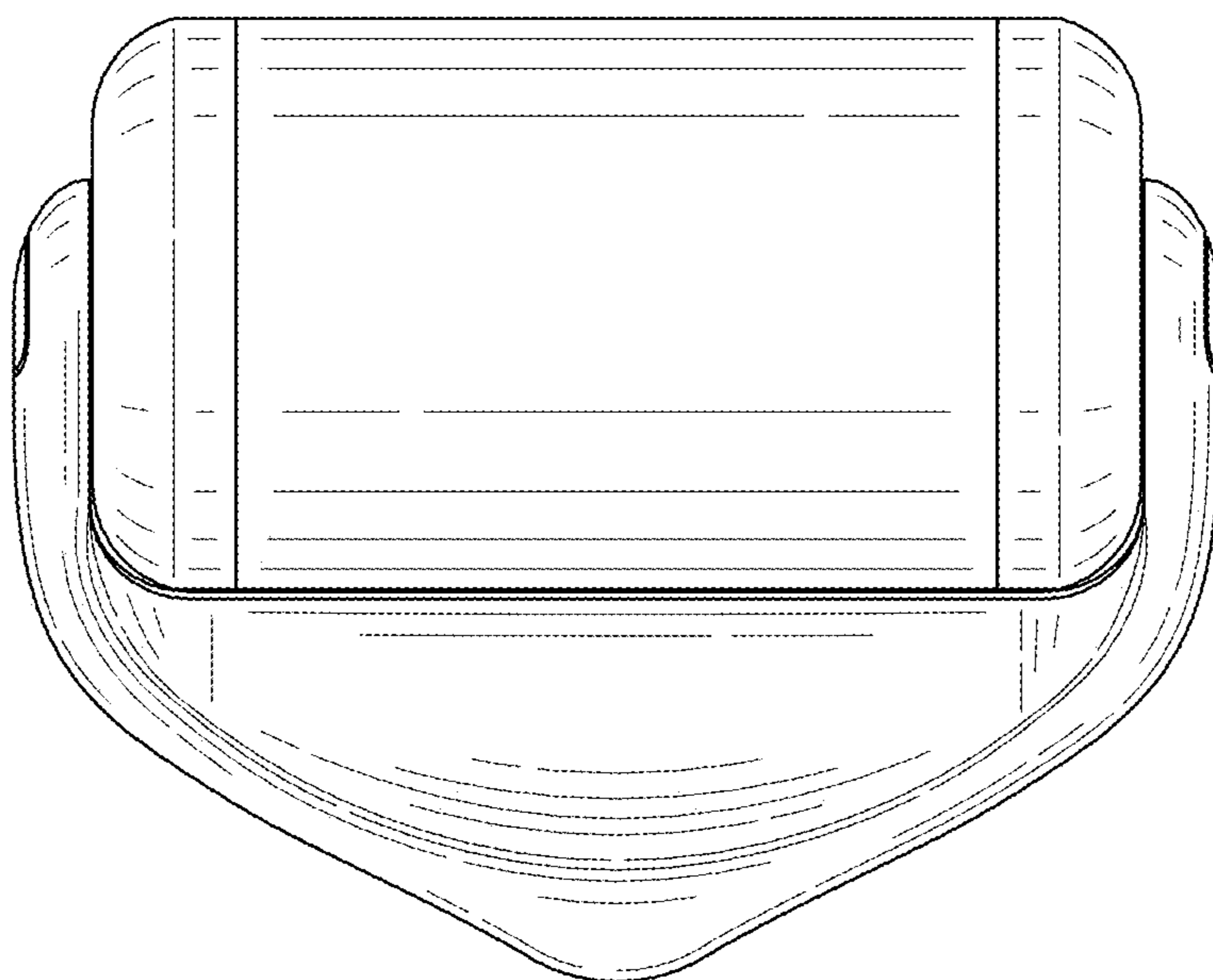
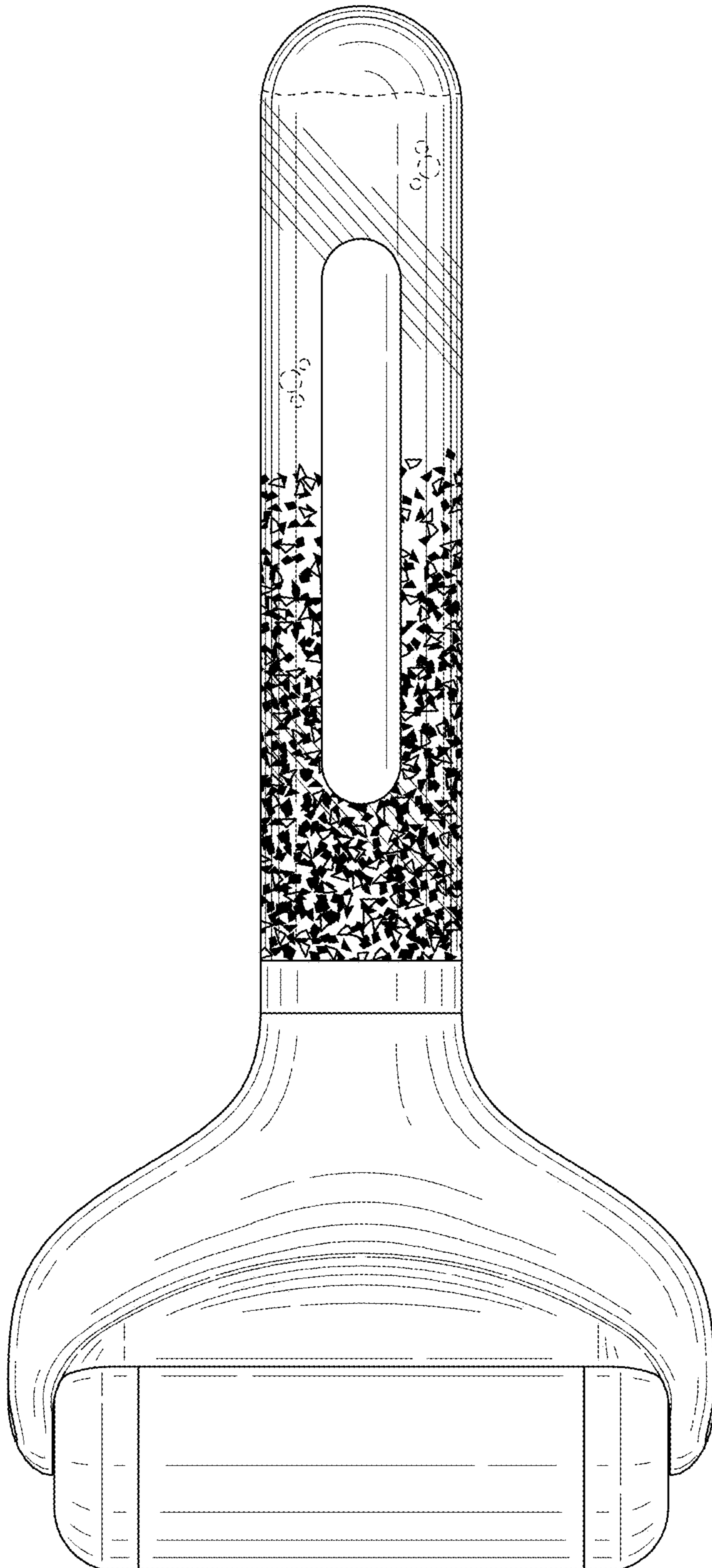


FIG. 9



**FIG. 10**





**FIG. 11**

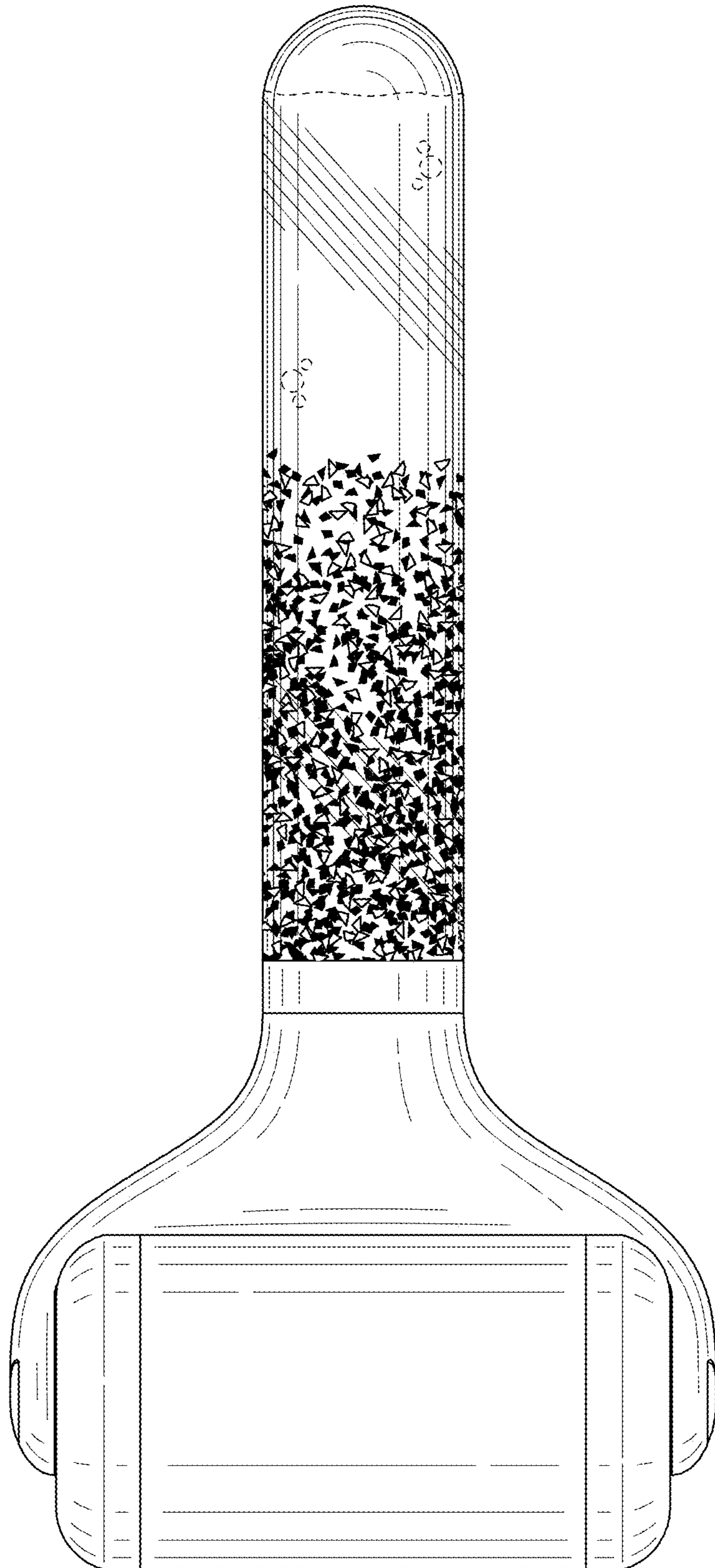
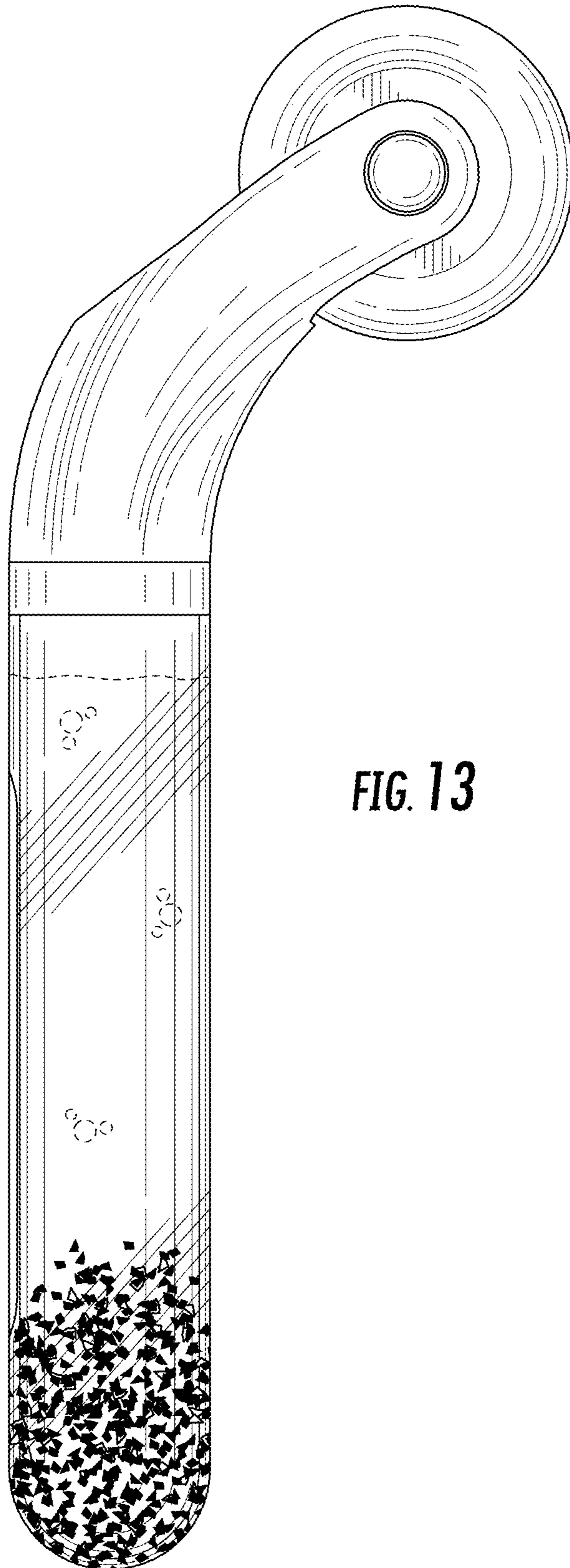


FIG. 12



**FIG. 13**



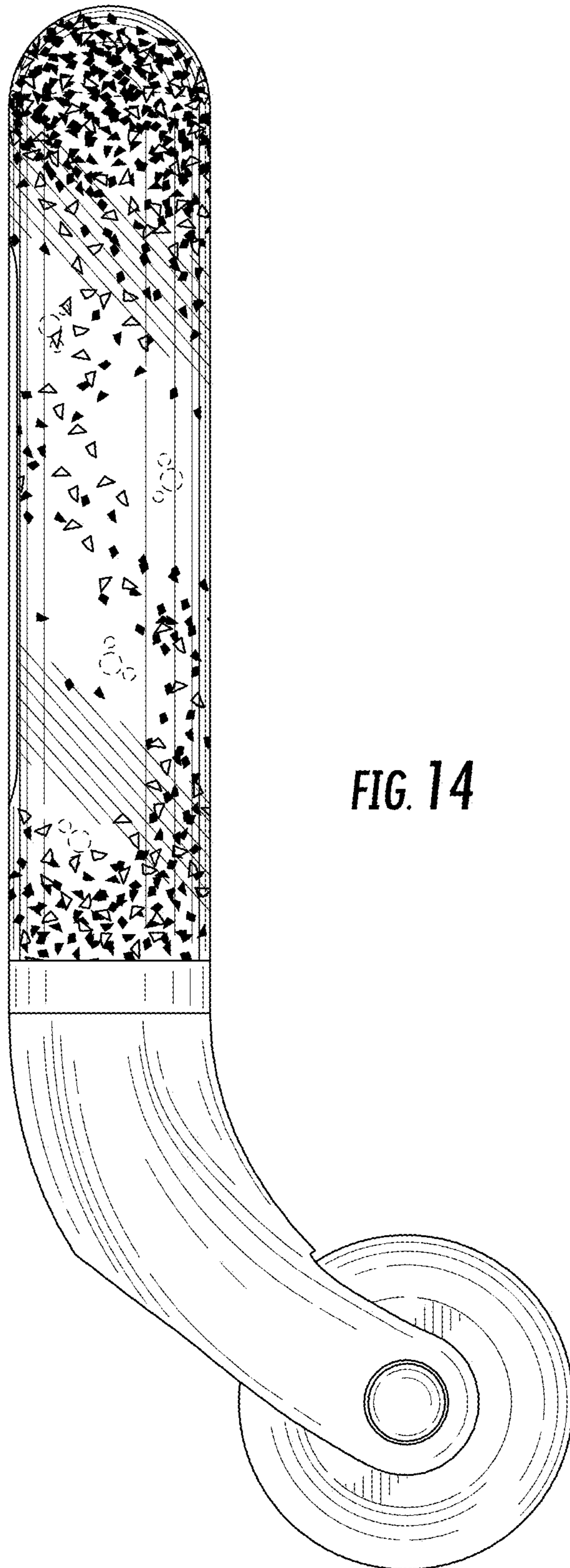
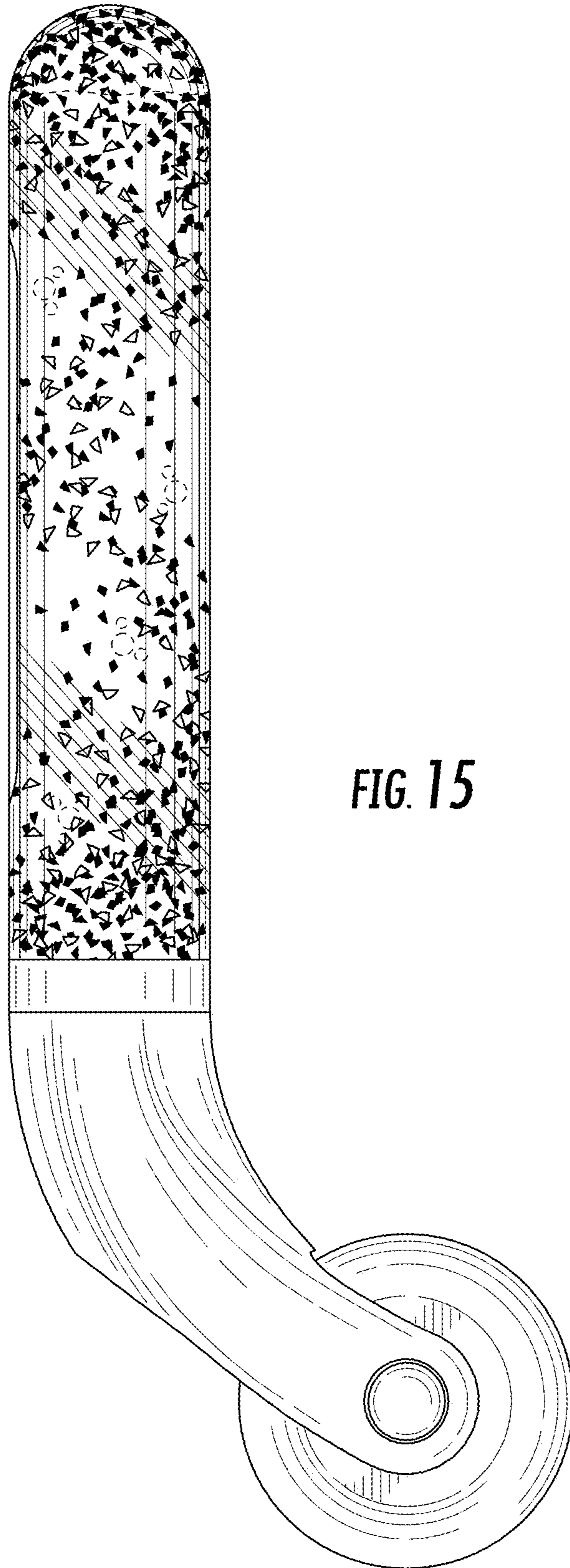


FIG. 14



**FIG. 15**

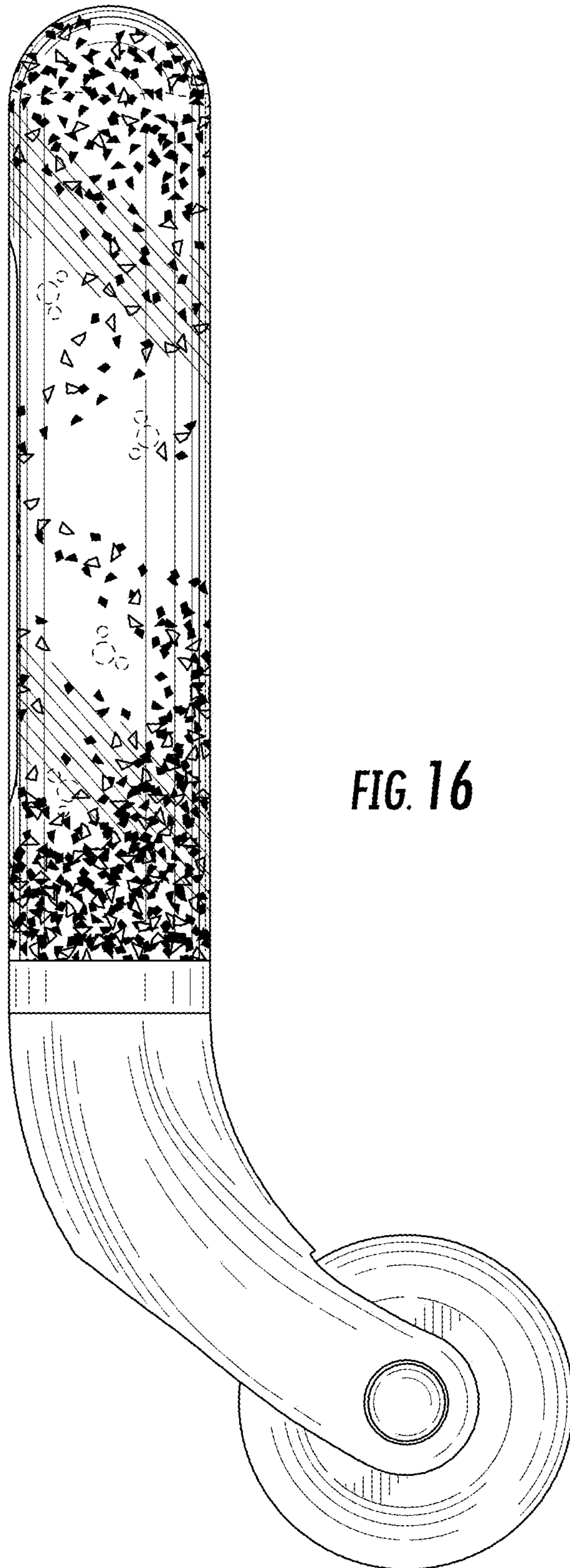
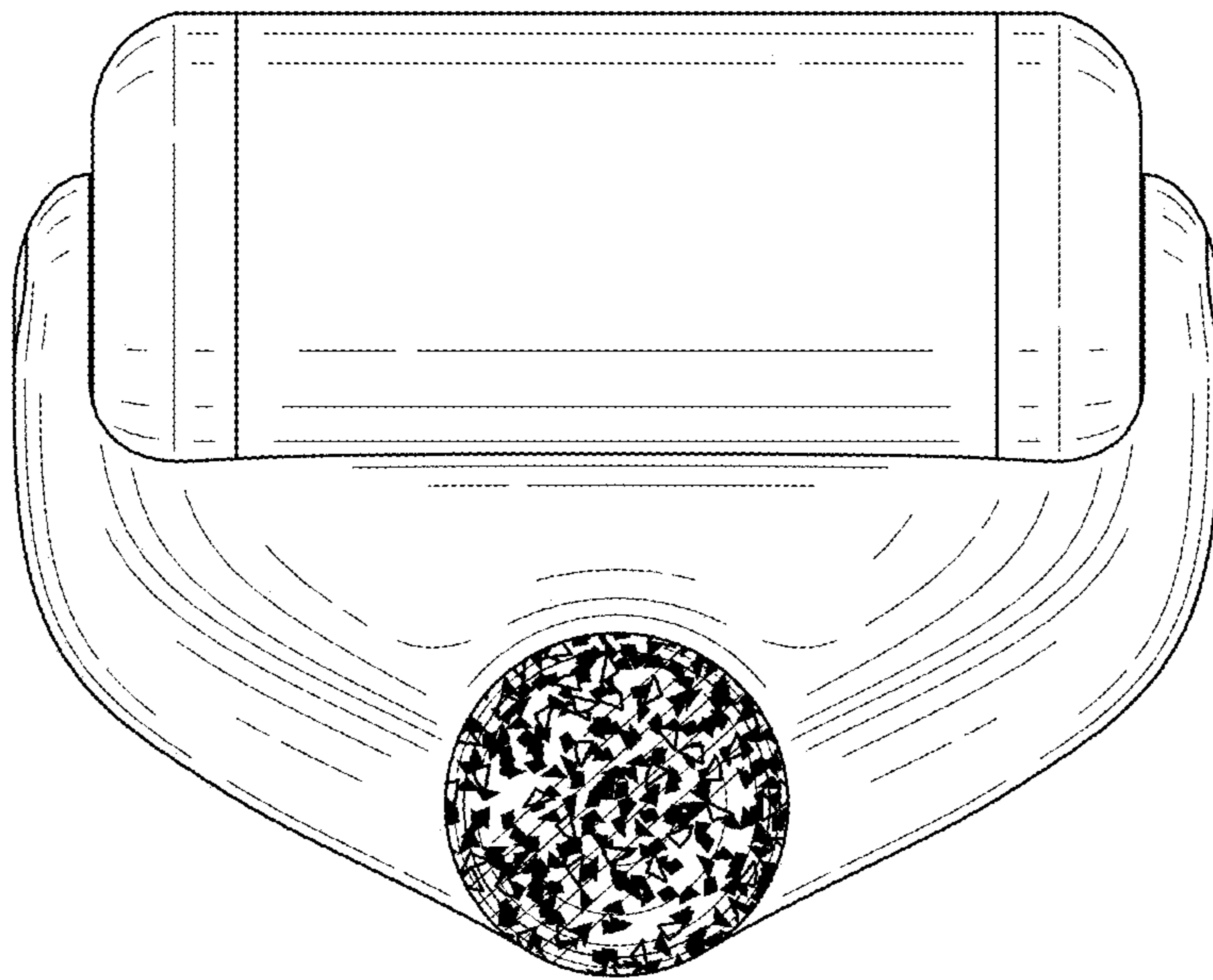
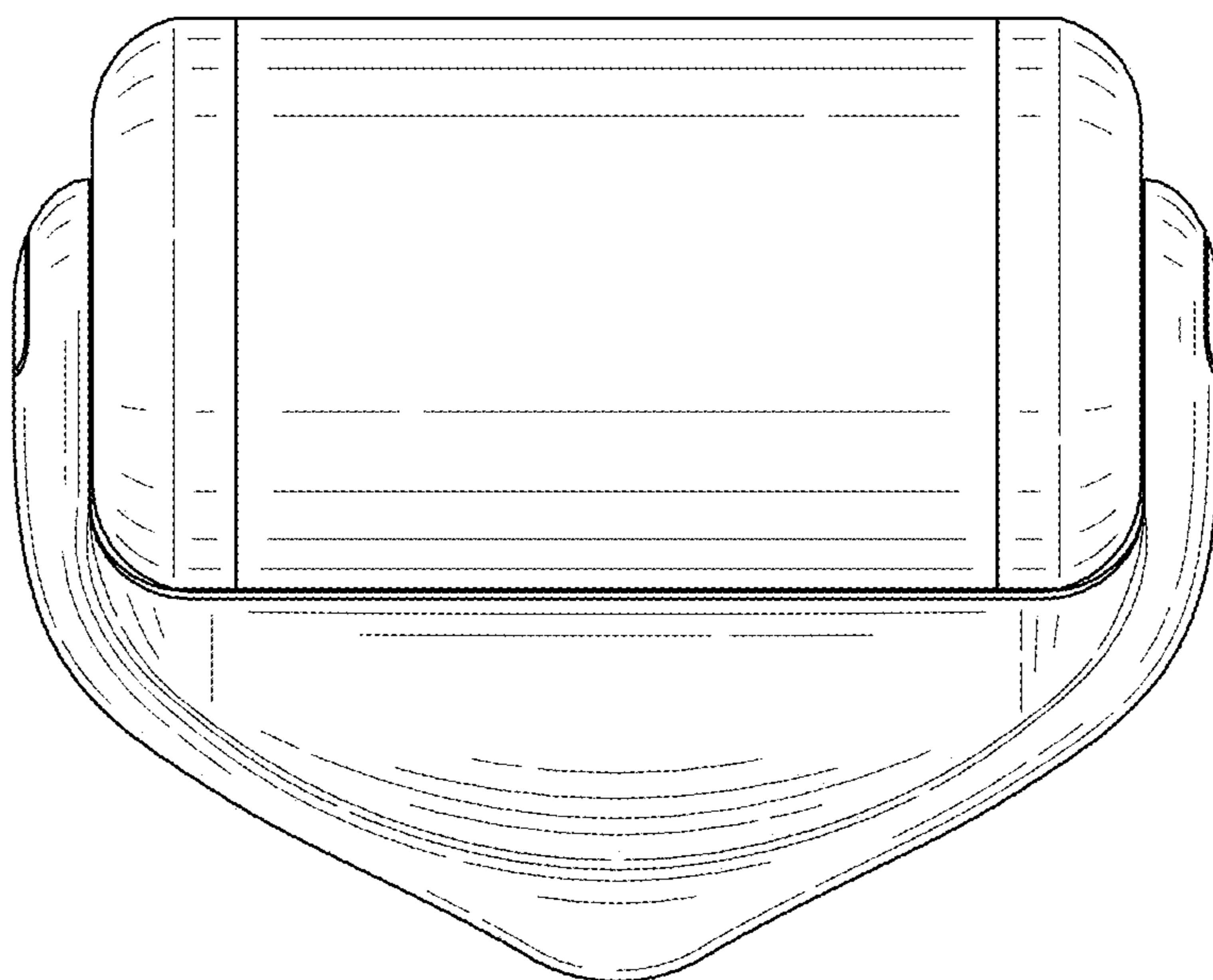


FIG. 16





**FIG. 17**



**FIG. 18**



**FIG. 19**

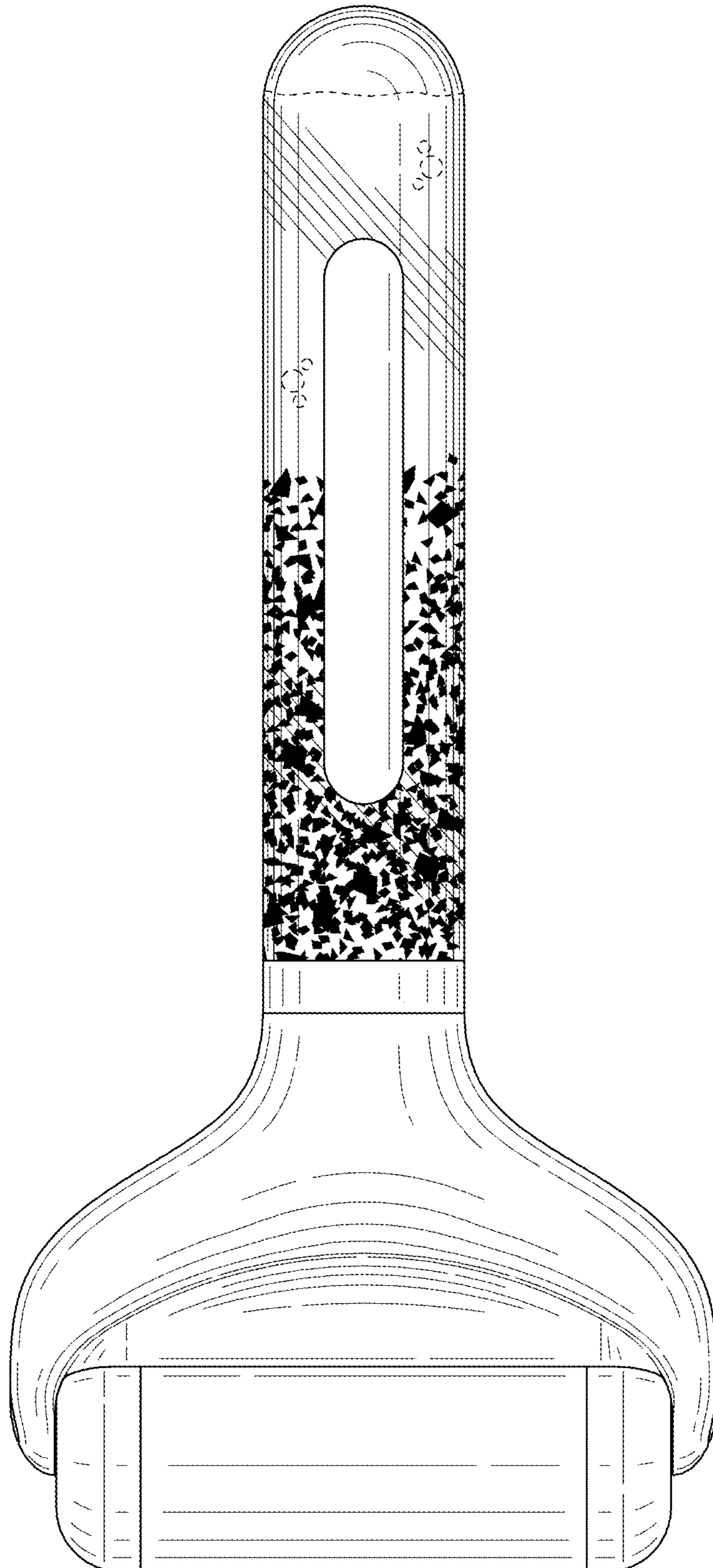


FIG. 20

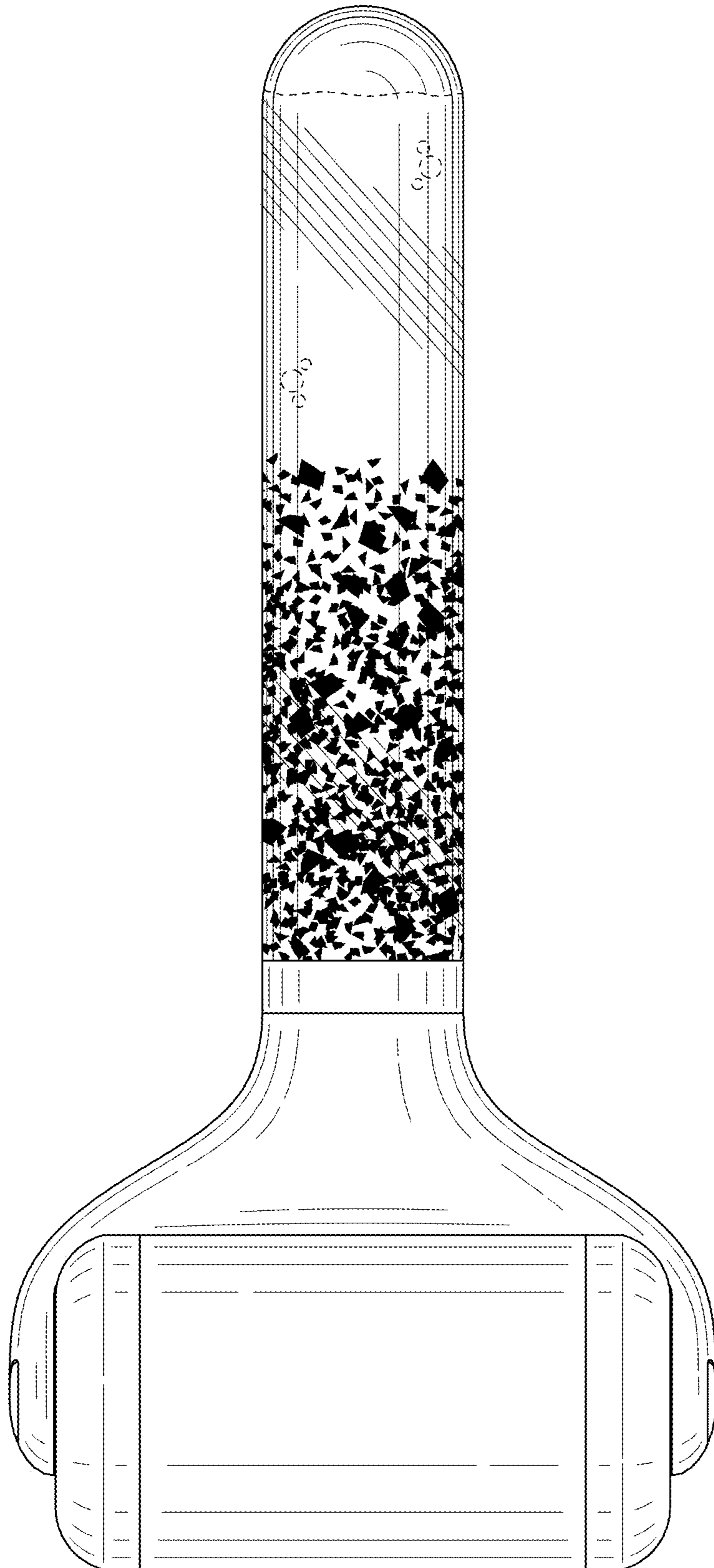


FIG. 21



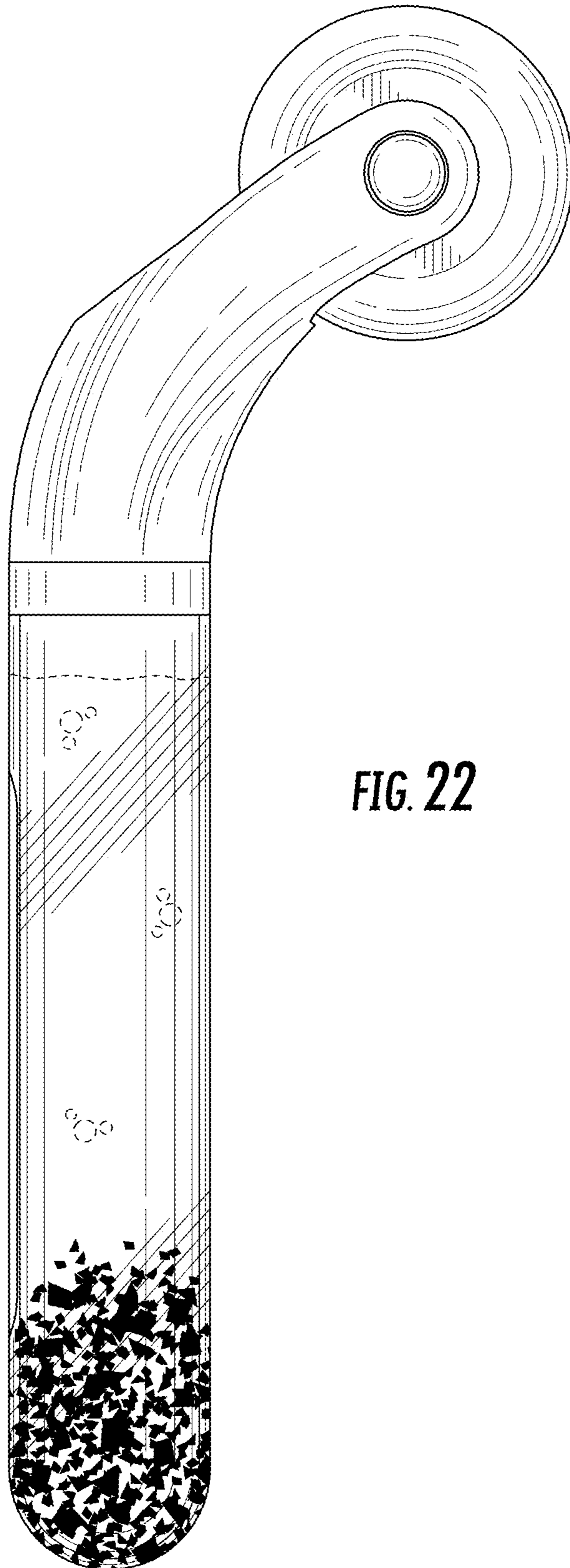
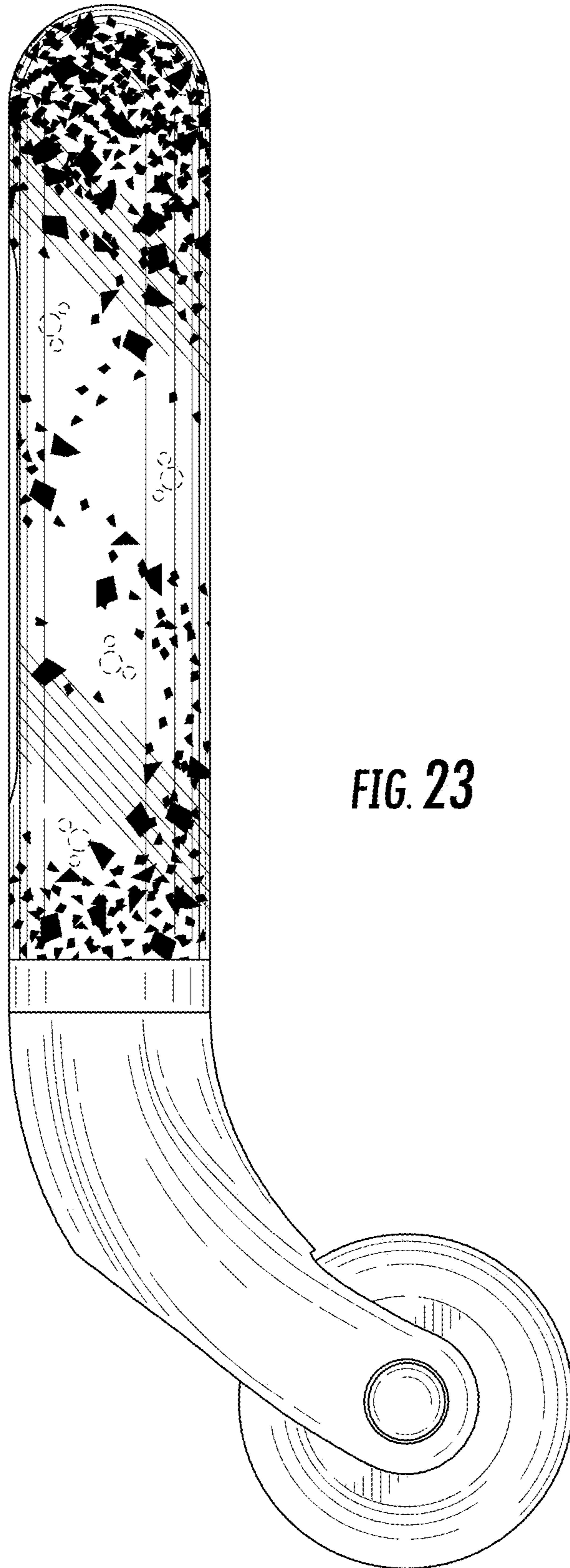


FIG. 22



**FIG. 23**

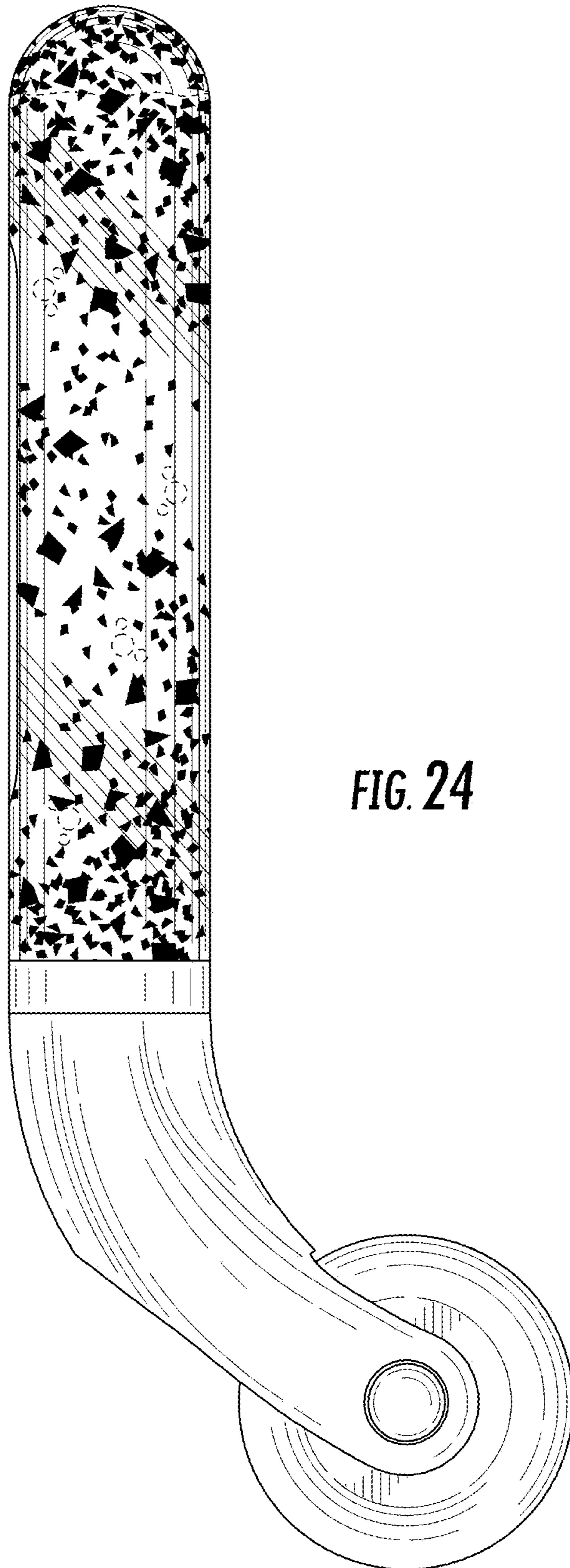


FIG. 24

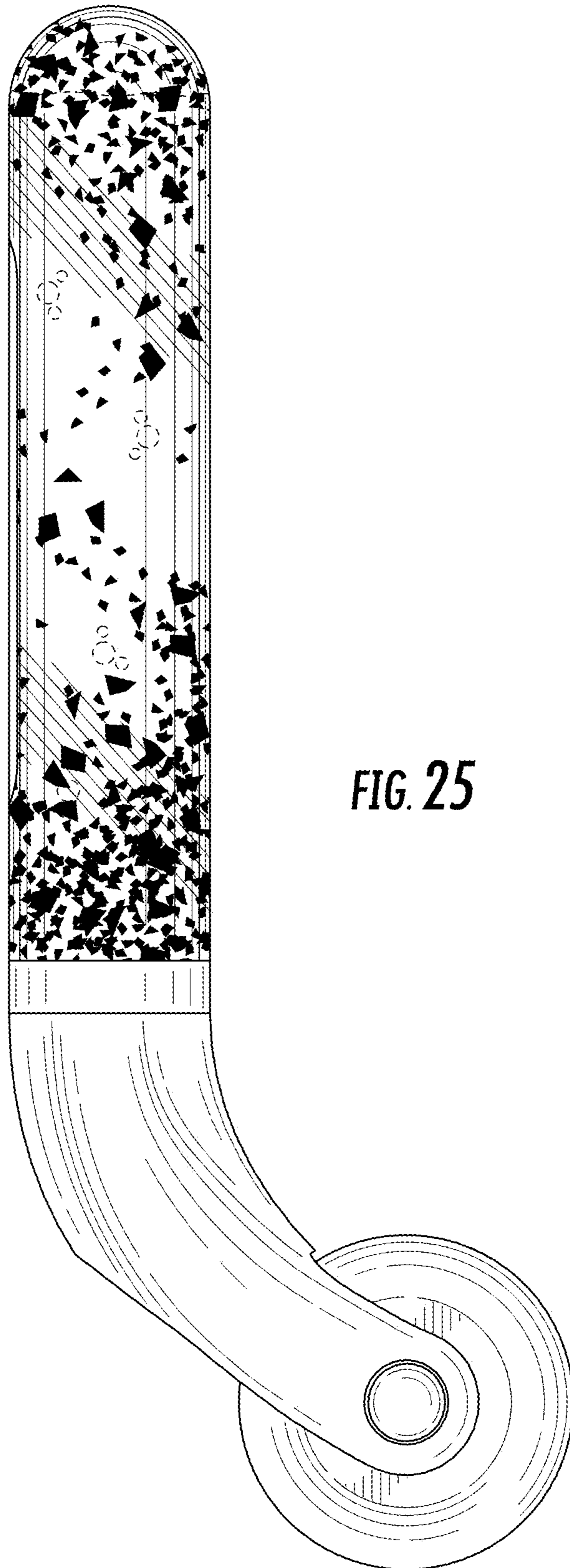


FIG. 25



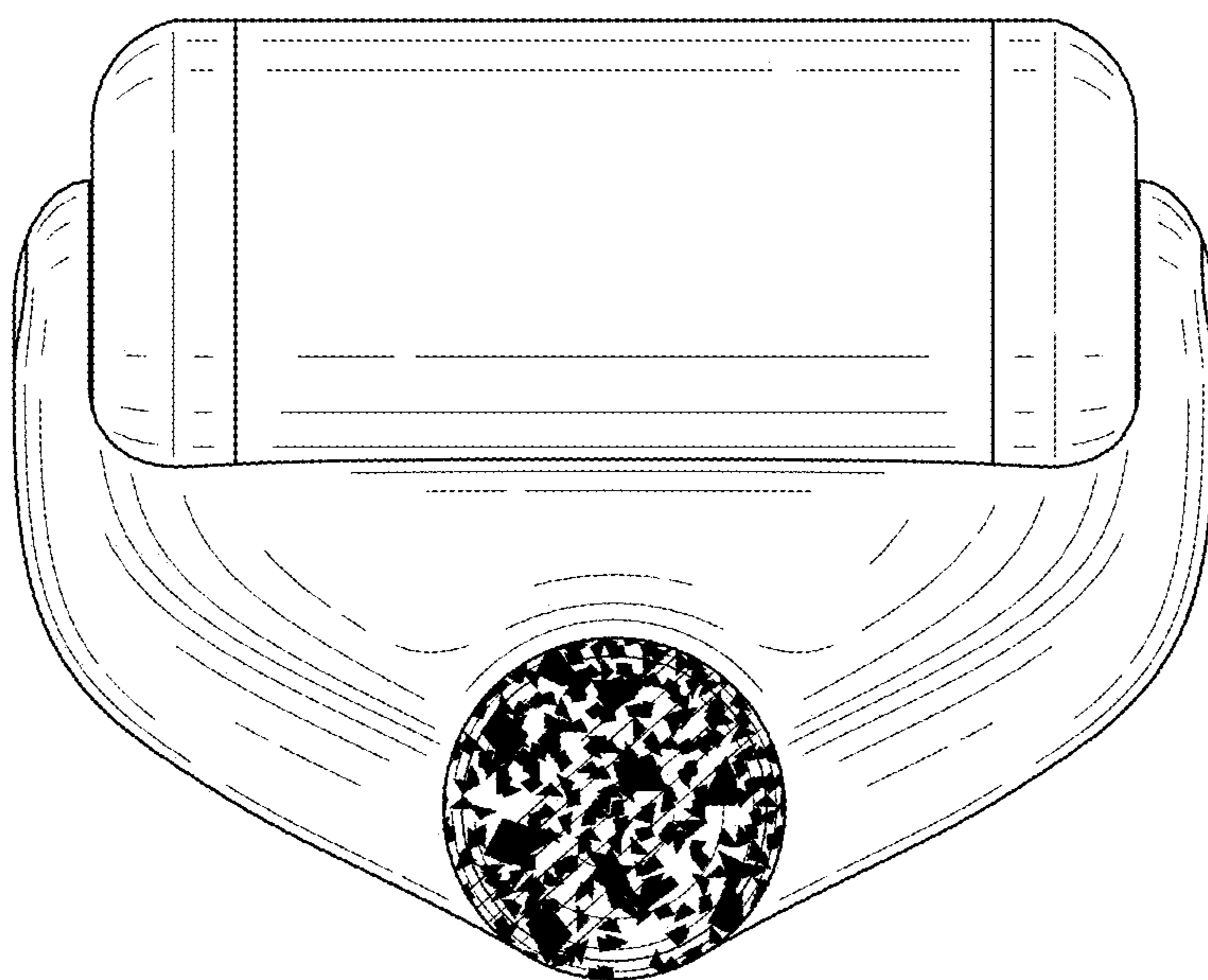


FIG. 26

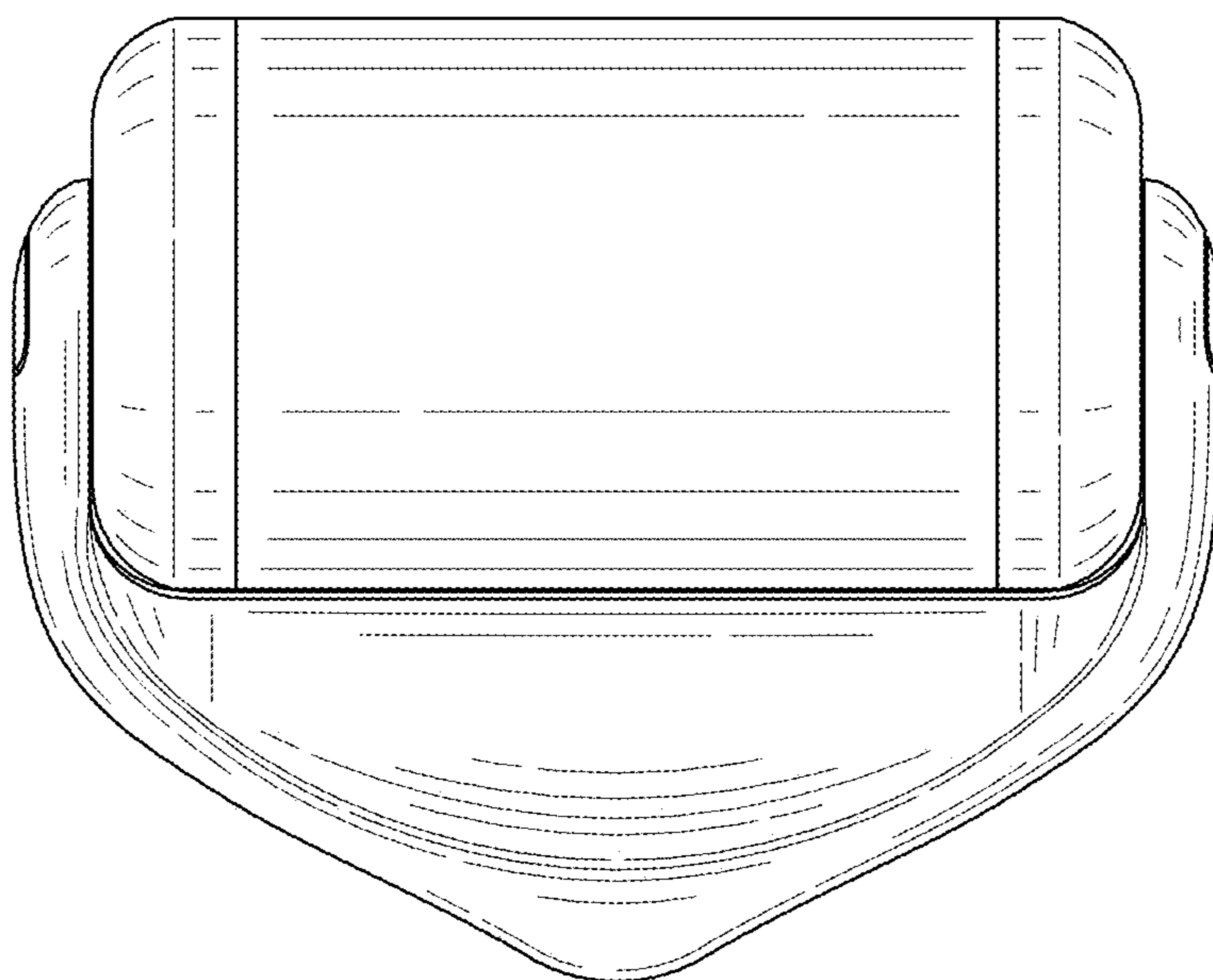


FIG. 27



FIG. 28

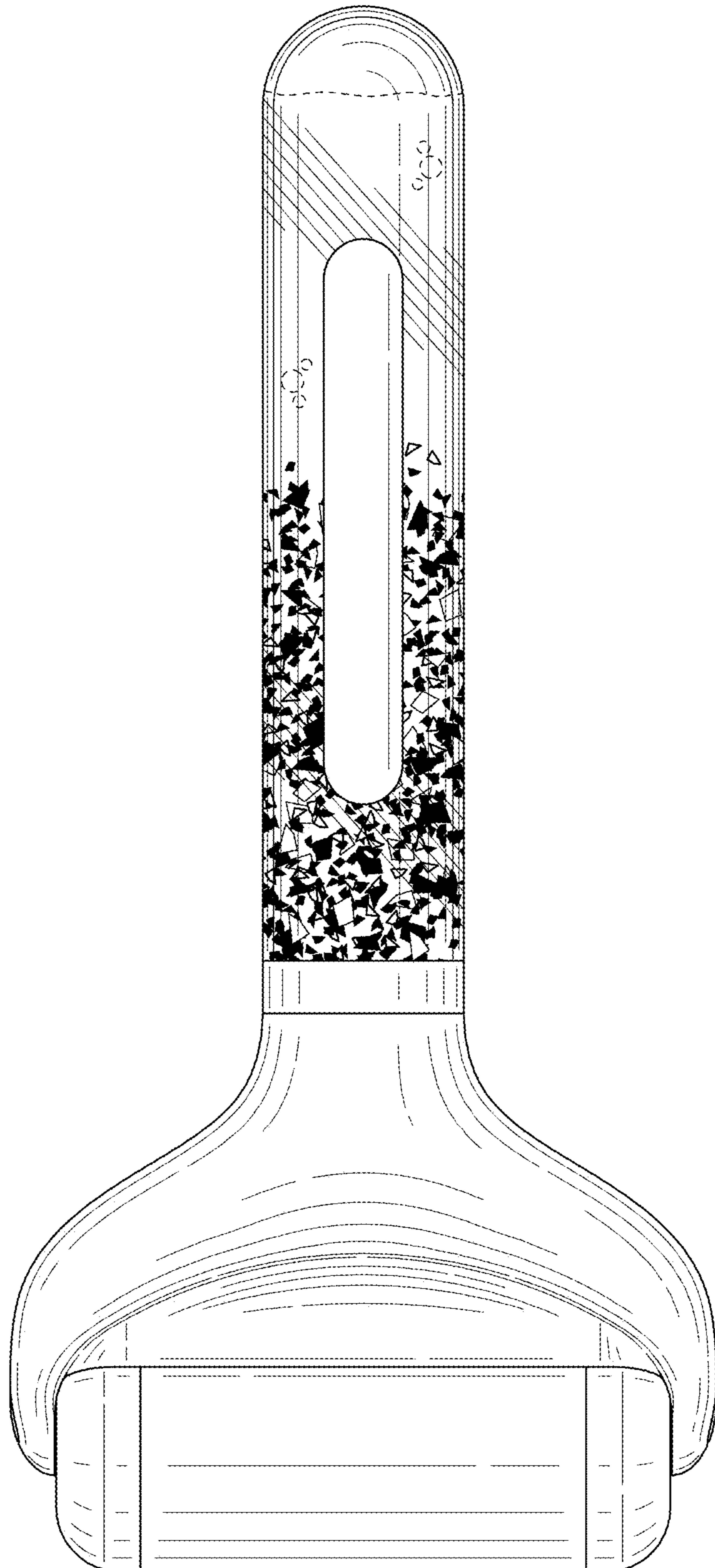
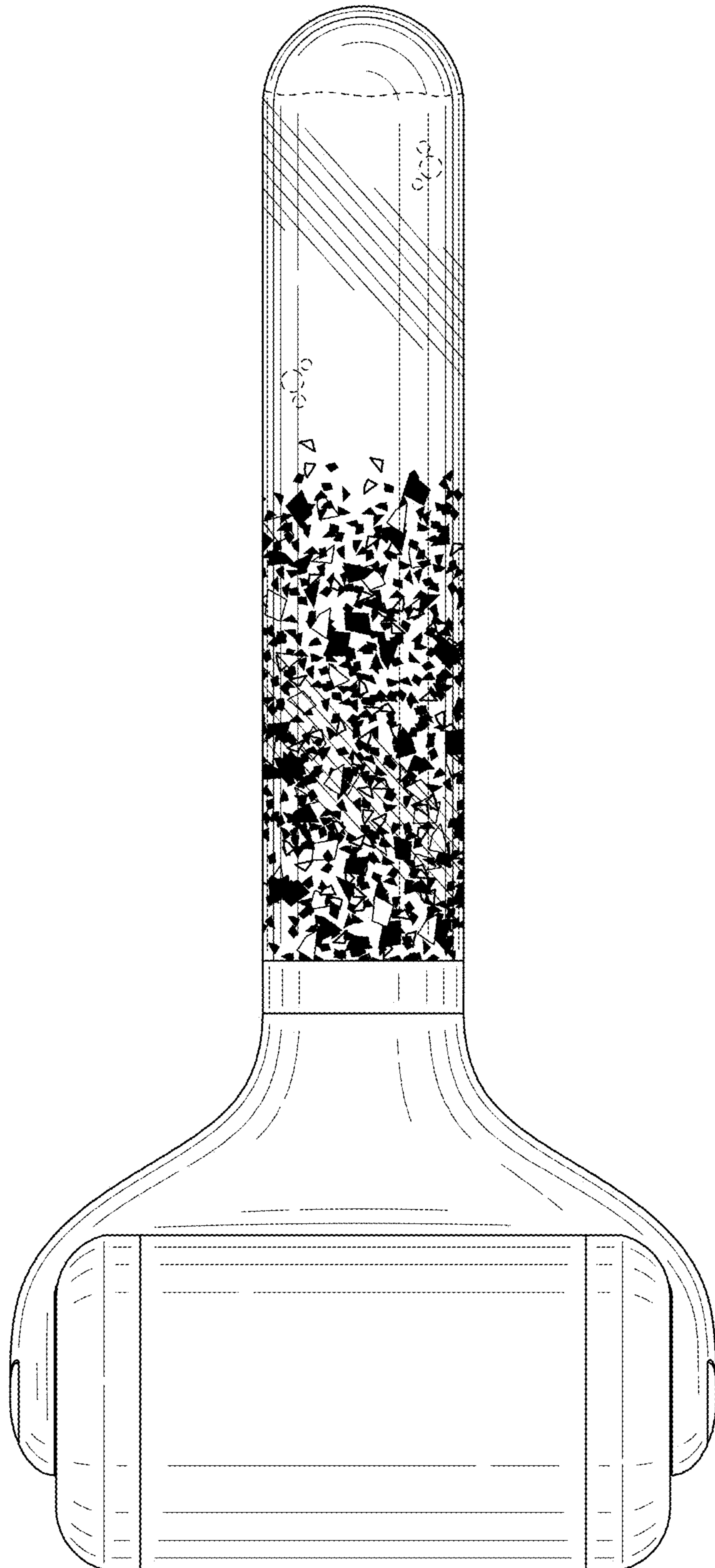
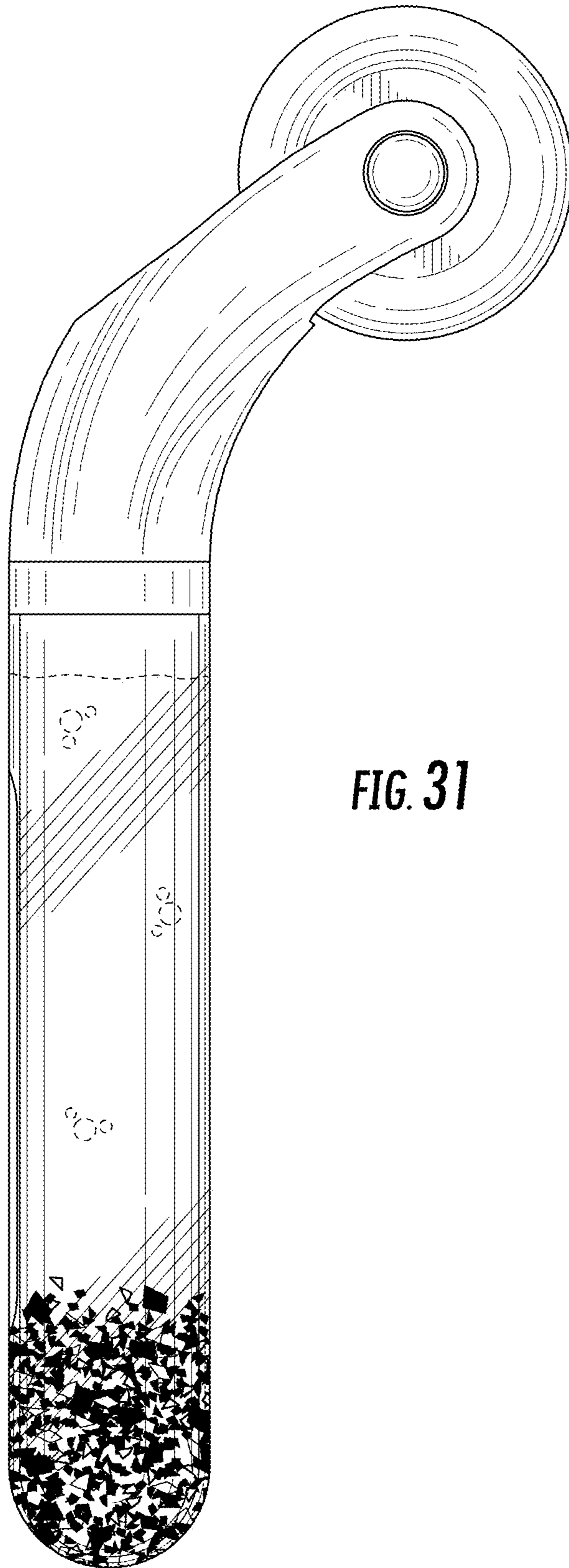


FIG. 29

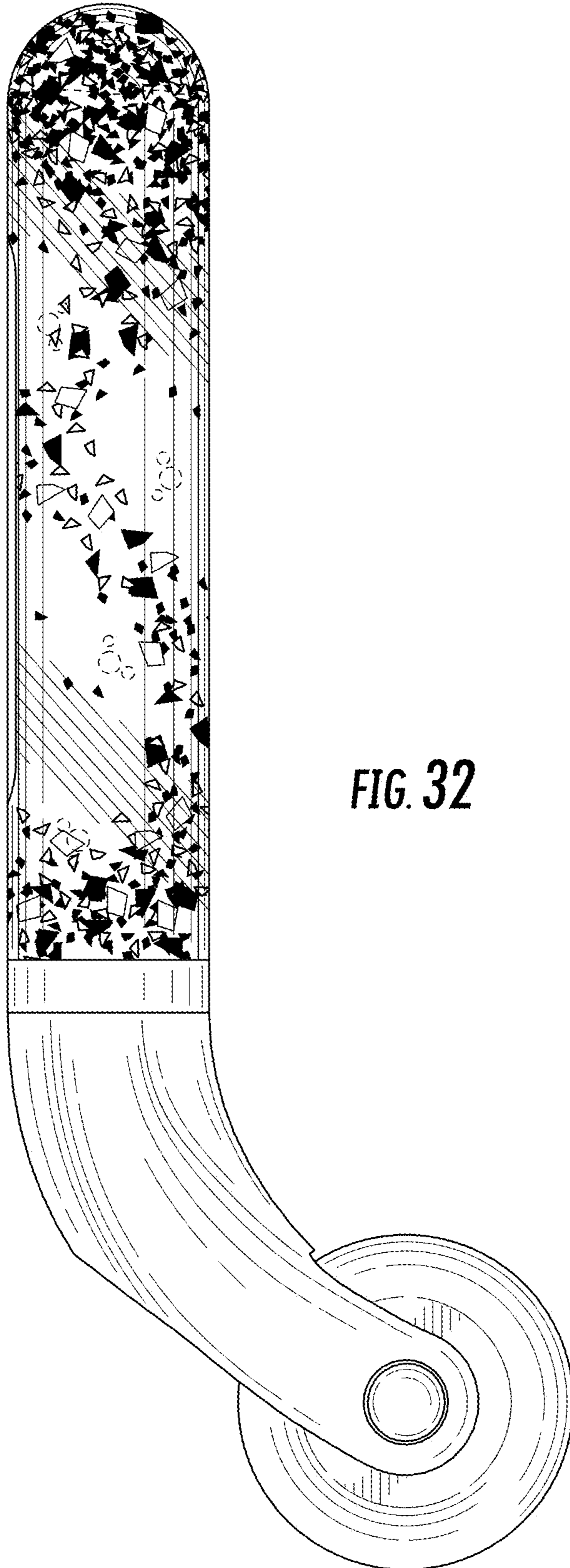


**FIG. 30**

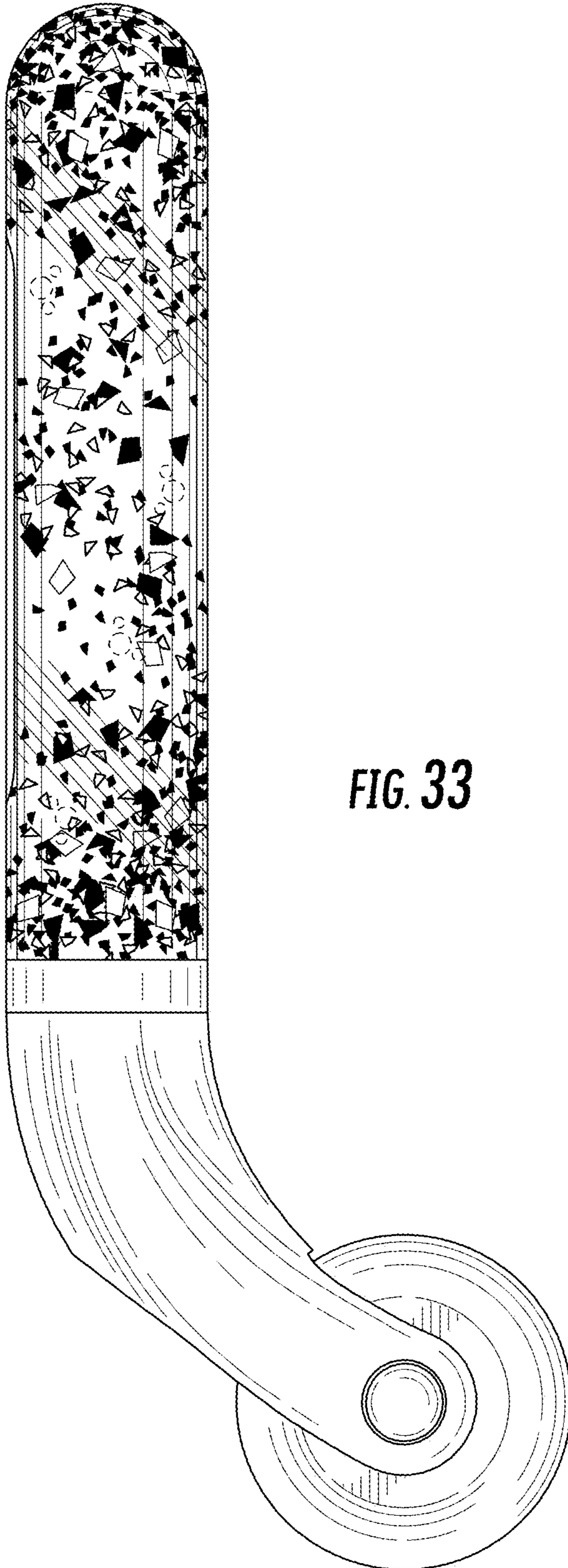




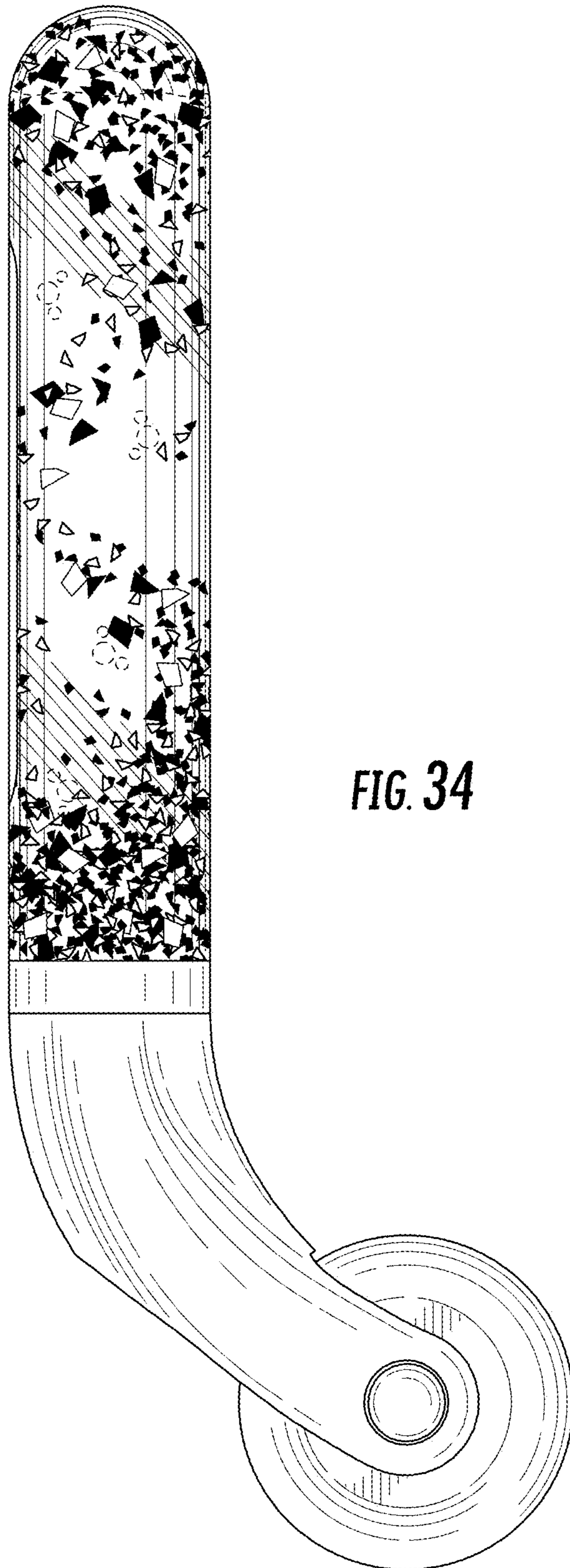
**FIG. 31**



**FIG. 32**

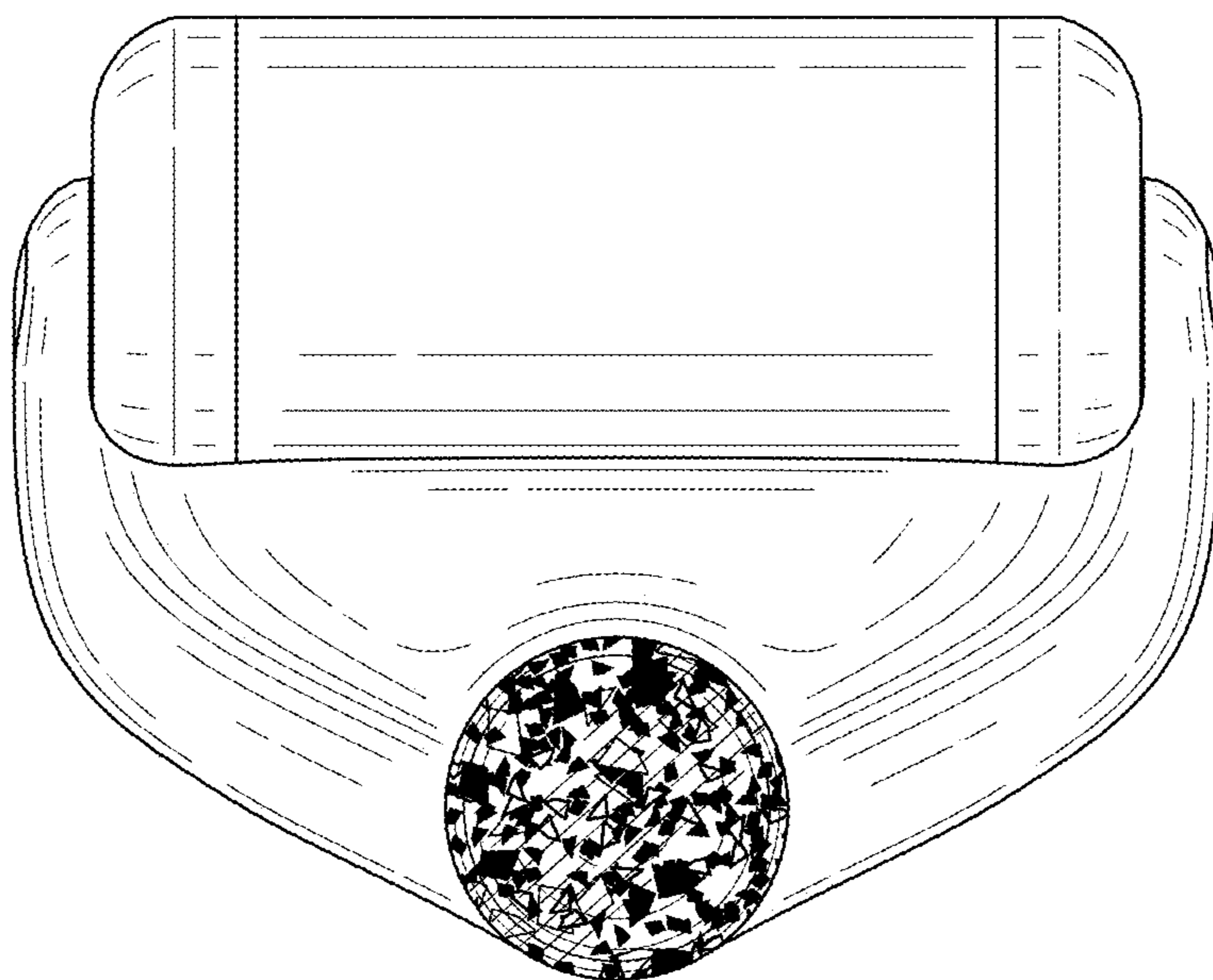


**FIG. 33**

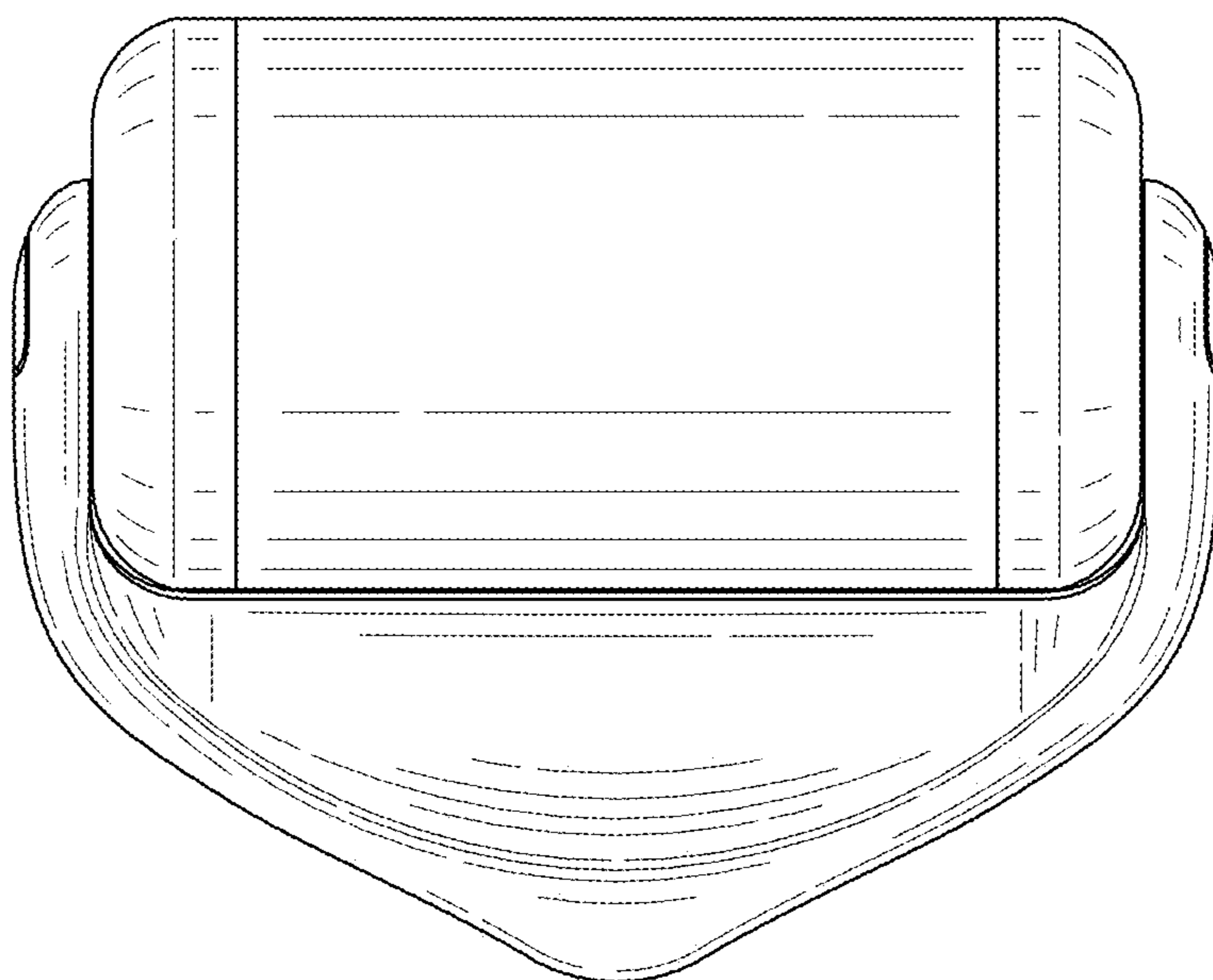


**FIG. 34**





**FIG. 35**



**FIG. 36**