



US00D949353S

(12) **United States Design Patent**  
**Foy**

(10) **Patent No.:** **US D949,353 S**  
(45) **Date of Patent:** **\*\* Apr. 19, 2022**

(54) **SPA**  
(71) Applicant: **9213-4550 QUÉBEC INC.,**  
Drummondville (CA)  
(72) Inventor: **Jérôme Foy, Orford (CA)**  
(73) Assignee: **9213-4550 QUÉBEC INC.,**  
Drummondville (CA)

(\*\*) Term: **15 Years**

(21) Appl. No.: **29/758,257**

(22) Filed: **Nov. 13, 2020**

(30) **Foreign Application Priority Data**

Jun. 5, 2020 (CA) ..... CA 196071

(51) **LOC (13) Cl.** ..... **23-02**

(52) **U.S. Cl.**  
USPC ..... **D24/204**

(58) **Field of Classification Search**  
USPC ..... D24/201–205, 213; D23/276–278,  
D23/280.1–280.3; D25/2

CPC ..... A61H 33/6005; A61H 33/6021; A61H  
33/6089; A61H 33/6094; A61H 2035/004;  
A61H 35/006; A47K 3/022; A47K 3/062  
See application file for complete search history.

(56) **References Cited**

**U.S. PATENT DOCUMENTS**

D559,960 S \* 1/2008 Breymaier ..... D23/277  
D559,991 S \* 1/2008 Dragovich ..... D24/204

D575,406 S \* 8/2008 Layfield ..... D24/204  
D702,846 S \* 4/2014 Larsen ..... D24/204  
D730,534 S \* 5/2015 Larsen ..... D24/204  
D783,846 S \* 4/2017 Goulet ..... D24/204  
D800,328 S \* 10/2017 Harder ..... D24/204  
10,149,574 B1 \* 12/2018 Harder ..... A61H 33/60  
D837,992 S \* 1/2019 Harder ..... D24/204  
D913,511 S \* 3/2021 Baker ..... D24/204  
2003/0014811 A1 \* 1/2003 Hammock ..... A47K 3/062  
4/541.1  
2015/0196167 A1 \* 7/2015 Dragovic ..... A47K 3/06  
4/584  
2018/0243165 A1 \* 8/2018 Koops ..... A61H 33/6005

\* cited by examiner

*Primary Examiner* — Anhdao Doan

(74) *Attorney, Agent, or Firm* — Norton Rose Fulbright  
Canada LLP; Alexandre Daoust

(57) **CLAIM**

I claim the ornamental design for a spa, as shown and described.

**DESCRIPTION**

FIG. 1 is a perspective view of a spa;  
FIG. 2 is a top view thereof;  
FIG. 3 is a front view thereof;  
FIG. 4 is a rear view thereof;  
FIG. 5 is a right side view thereof; and,  
FIG. 6 is a left side view thereof.  
The broken lines depict portions of the spa that form no part of the claimed design.

**1 Claim, 6 Drawing Sheets**

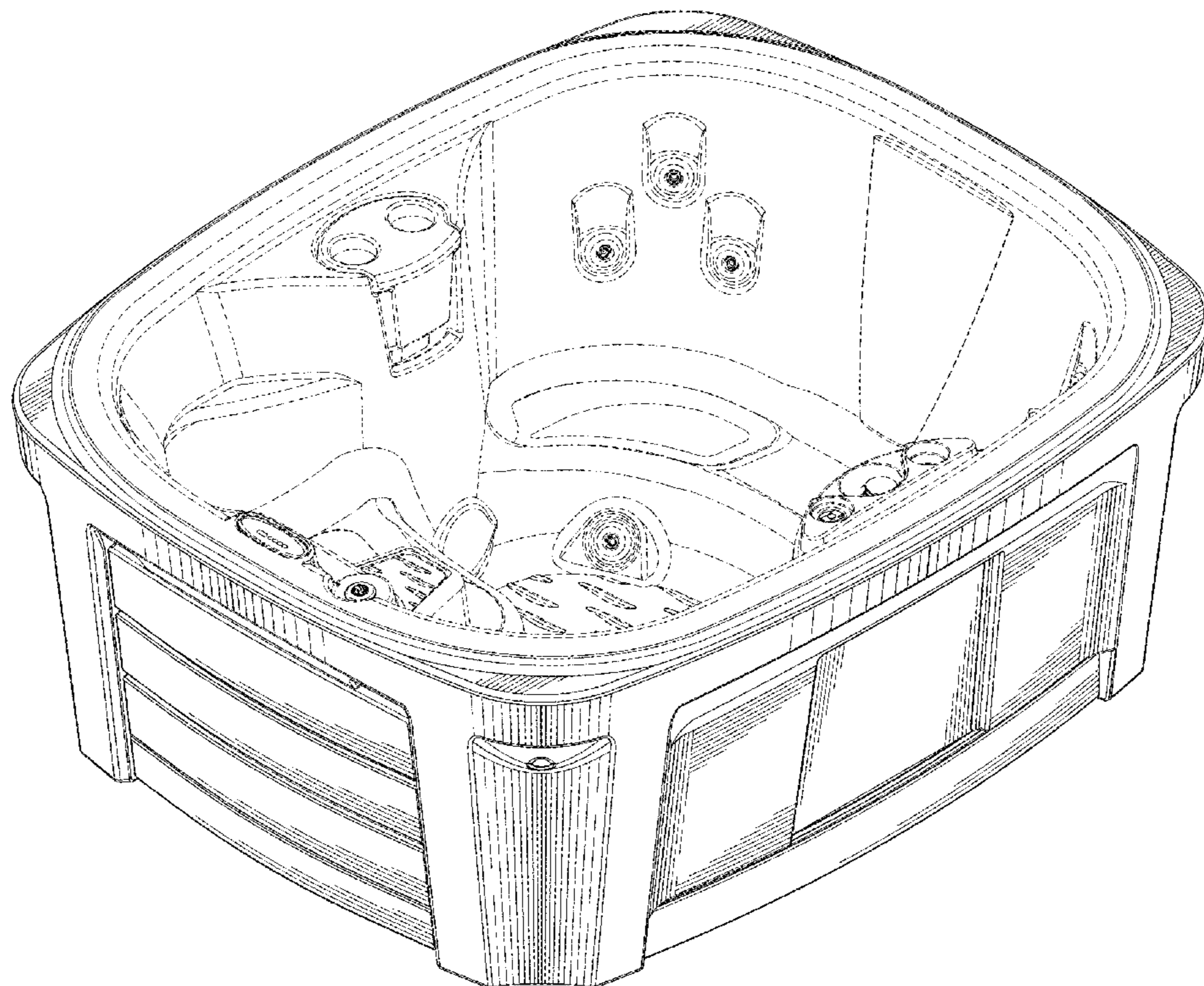

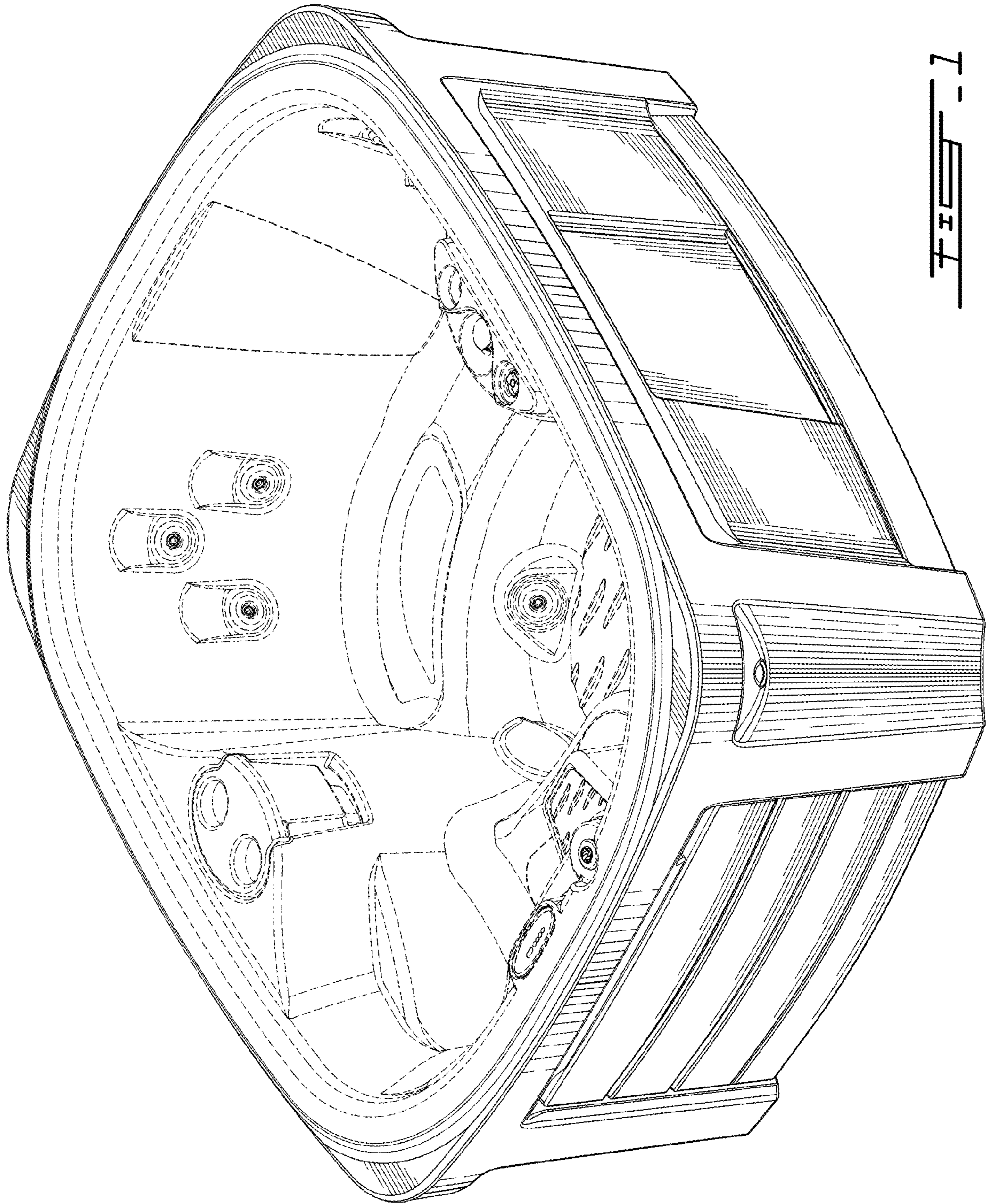

FIG. 1

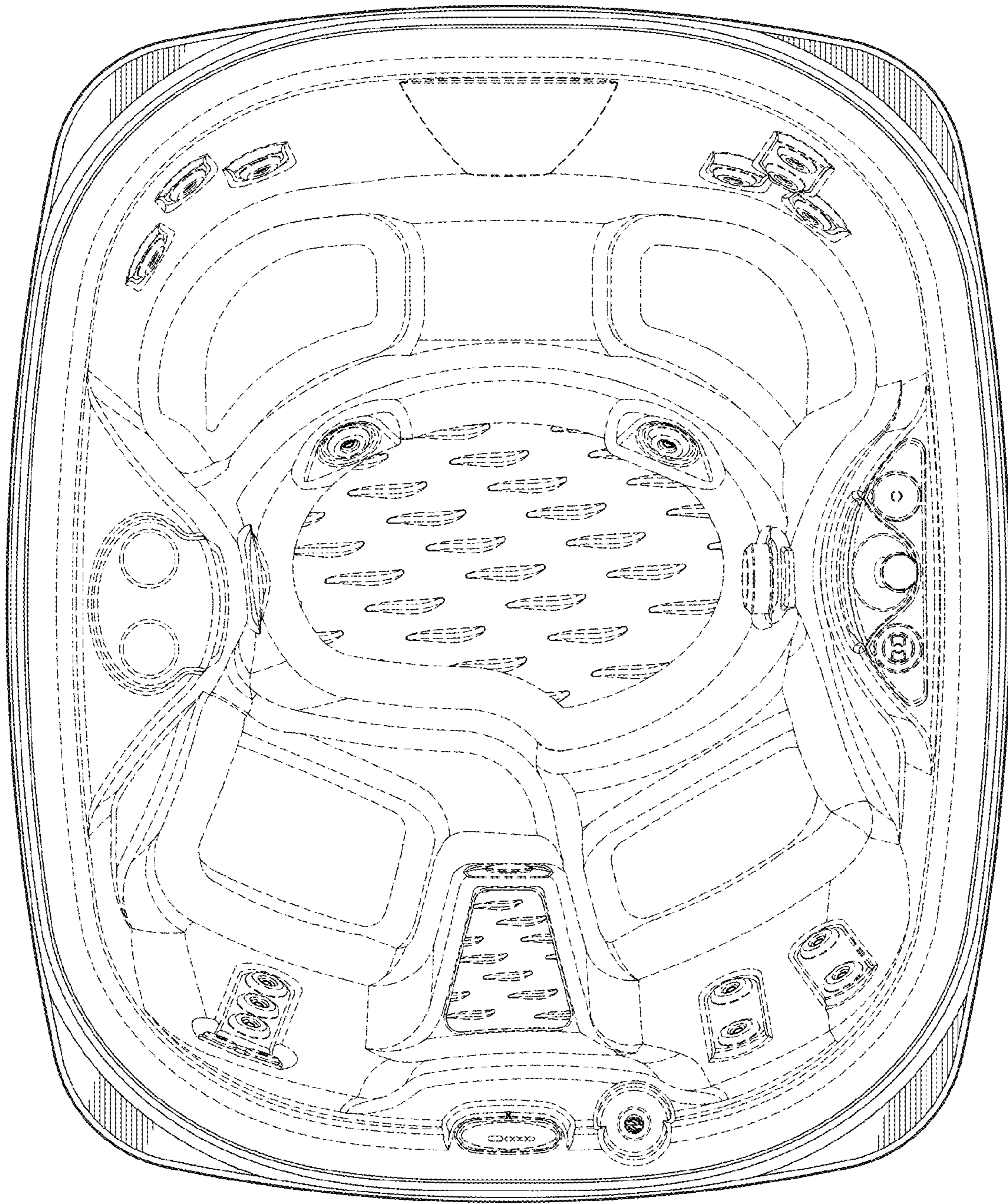

FIG. 2

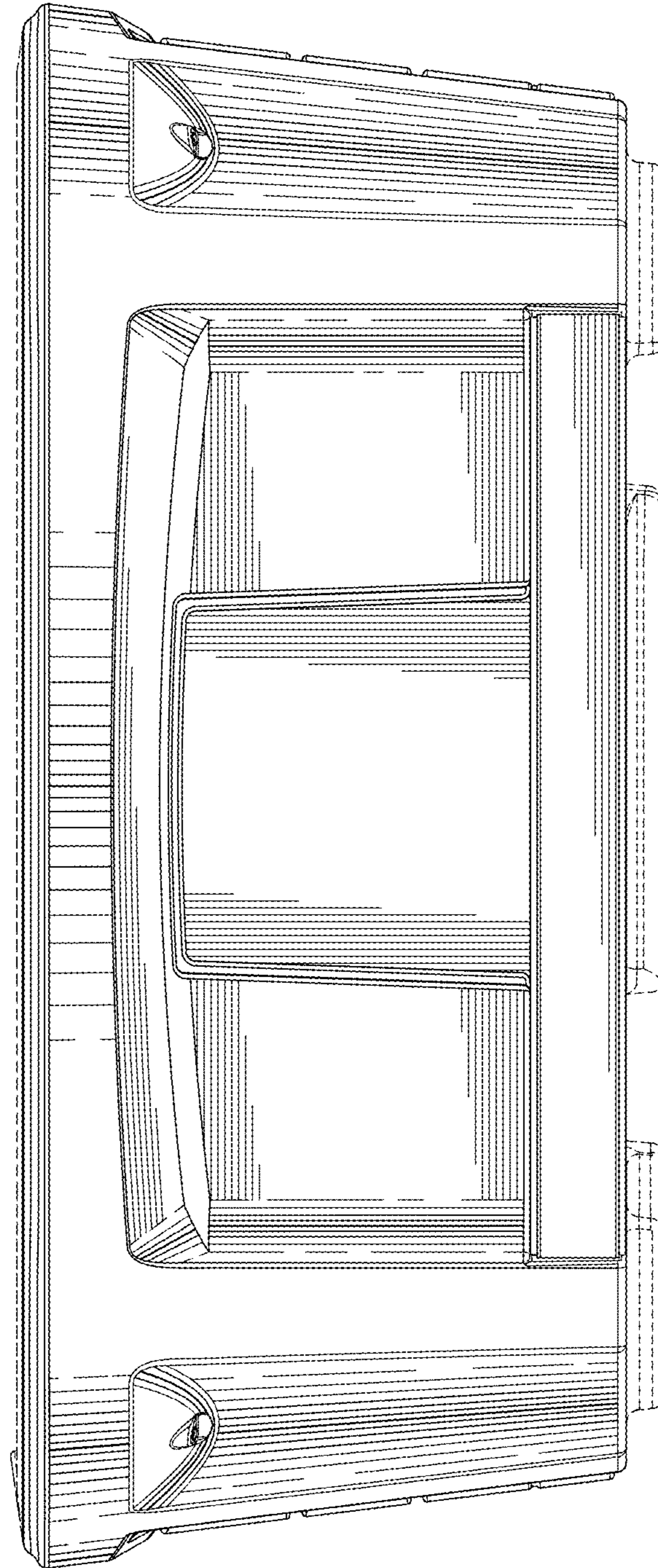

FIG. 3

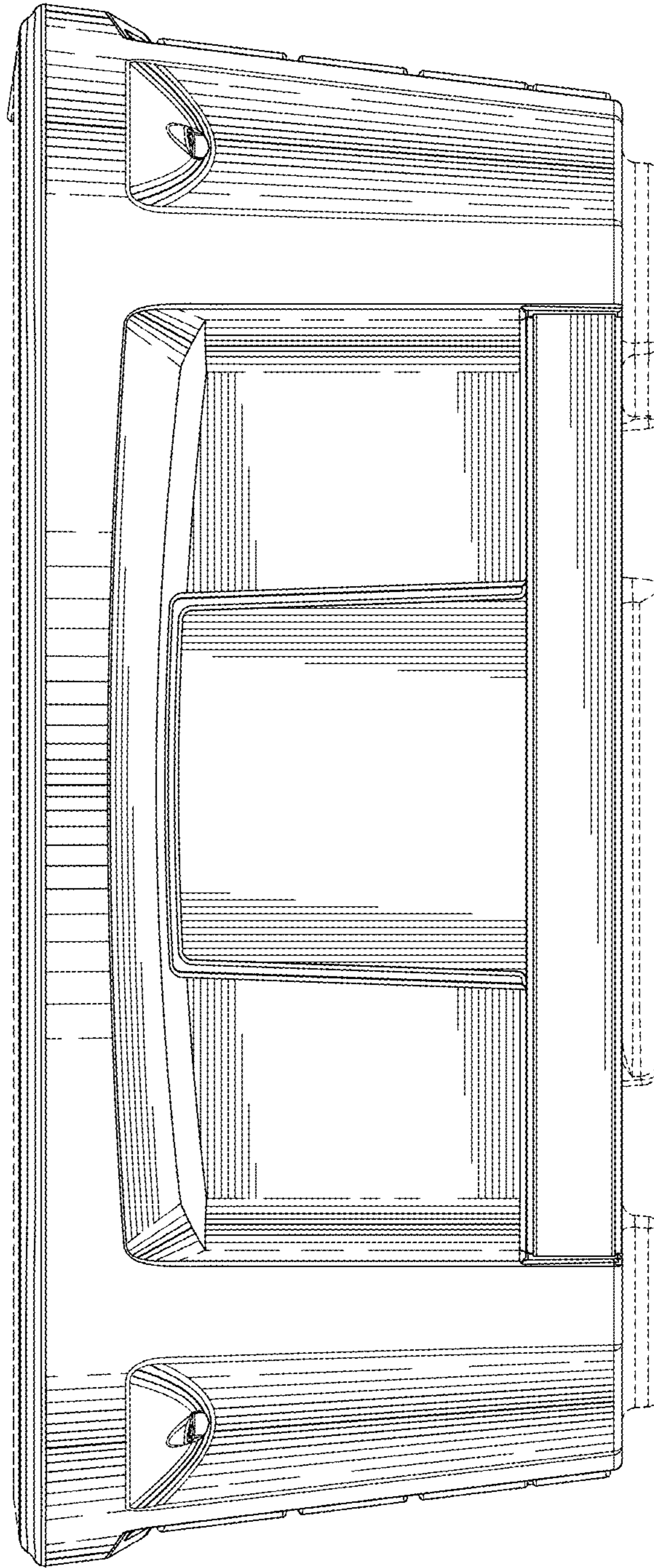
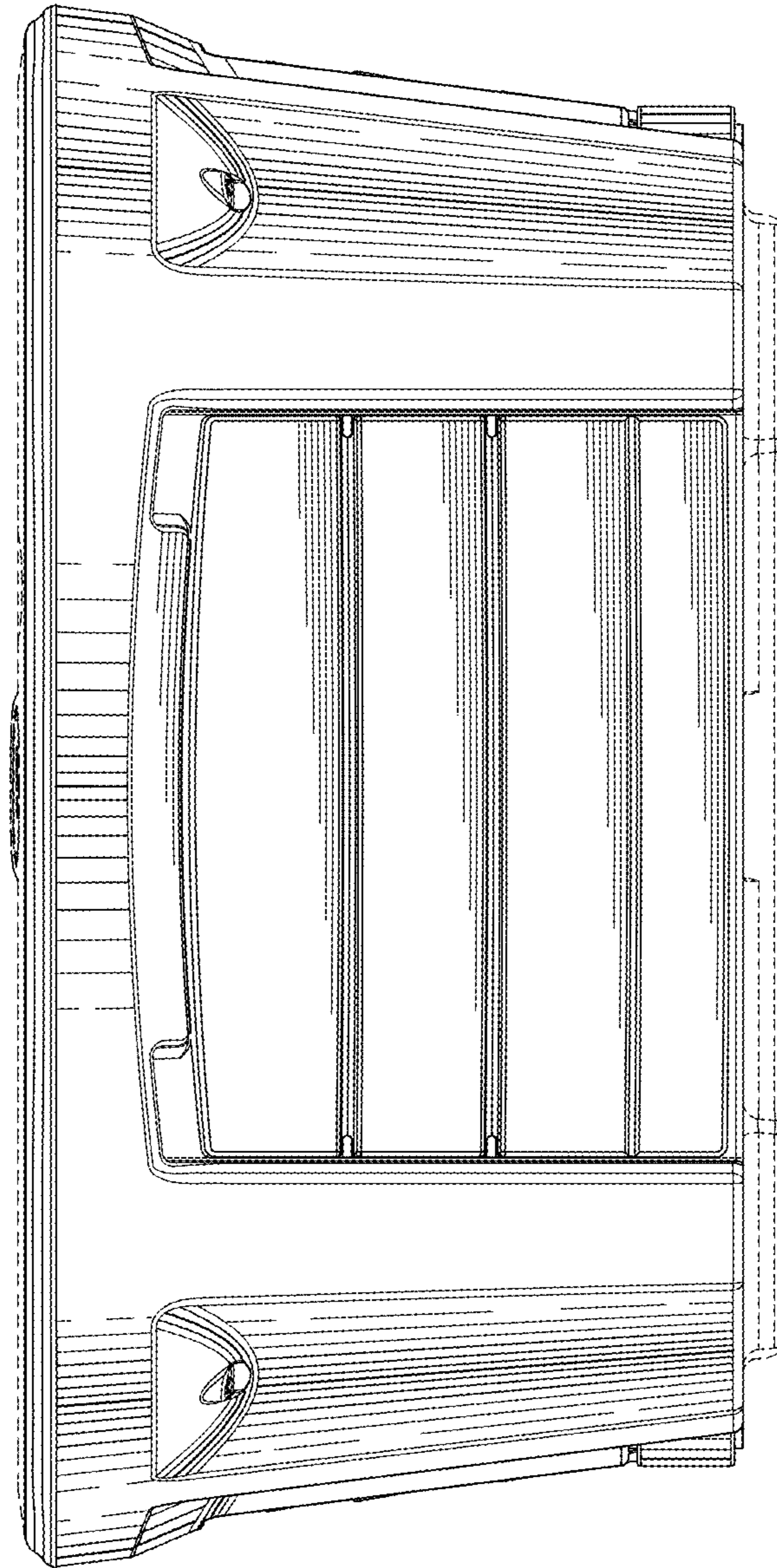

FIG. 4



*FIG. 5*

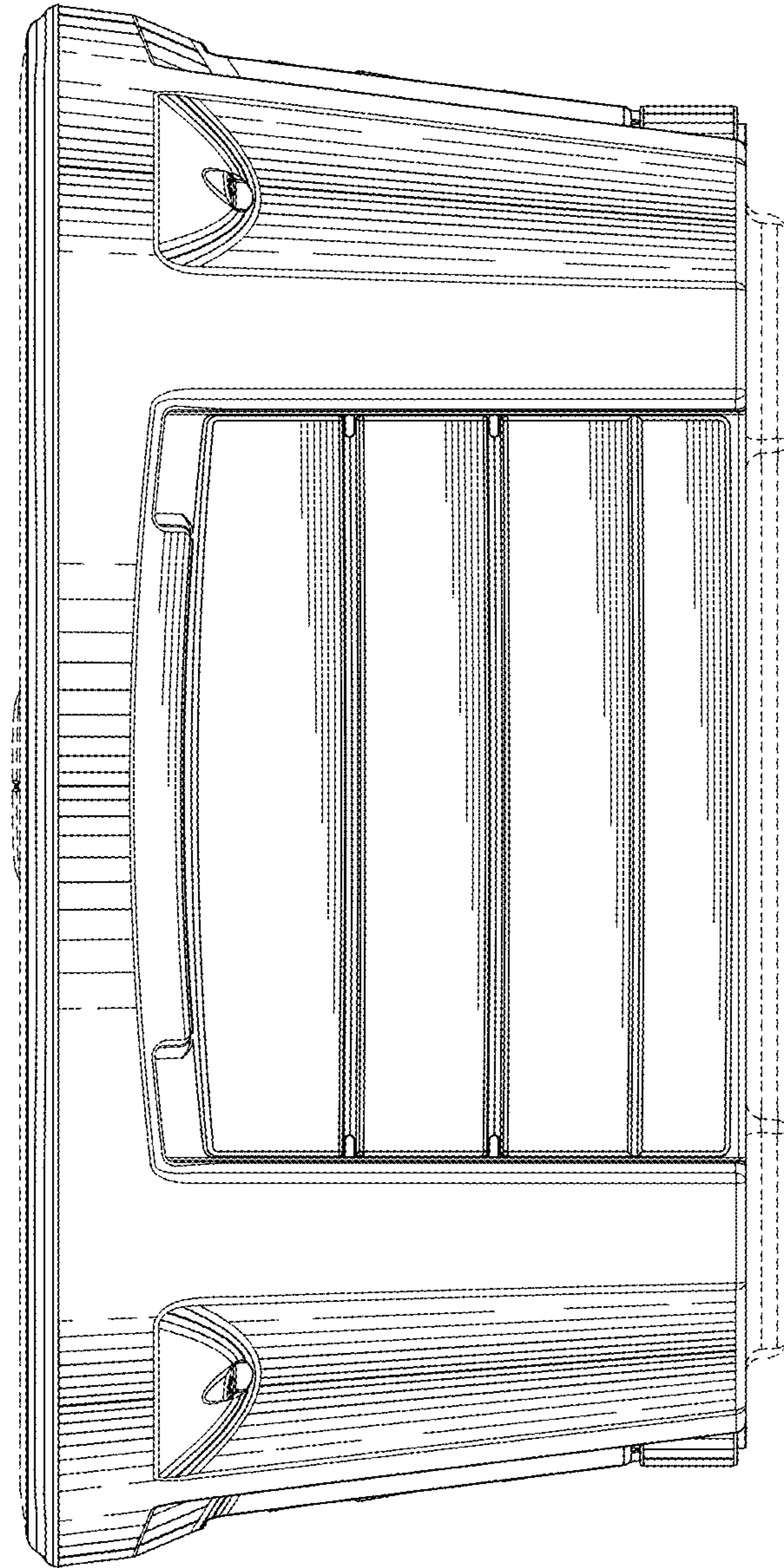

FIG. 6