



US00D949319S

(12) **United States Design Patent**
Jung et al.

(10) **Patent No.:** **US D949,319 S**

(45) **Date of Patent:** **** Apr. 19, 2022**

- (54) **EXHAUST DUCT**
- (71) Applicant: **ASM IP Holding B.V.**, Almere (NL)
- (72) Inventors: **DongRak Jung**, Cheonan-si (KR);
WooChan Kim, Hwaseong-si (KR);
Byeongpil Park, Hwaseong-si (KR)
- (73) Assignee: **ASM IP Holding B.V.**, Almere (NL)
- (**) Term: **15 Years**
- (21) Appl. No.: **29/702,874**
- (22) Filed: **Aug. 22, 2019**
- (51) **LOC (13) Cl.** **23-03**
- (52) **U.S. Cl.**
USPC **D23/393**
- (58) **Field of Classification Search**
USPC D23/259, 260, 318, 322, 343, 347, 348,
D23/354, 355, 370, 371, 373, 381, 382,
D23/385, 386, 387, 388, 389, 390, 392,
D23/393
CPC F24F 7/02; F24F 13/00; F24F 13/02; F24F
13/0209; F24F 13/06; F24F 13/0604;
F24F 13/10; F24F 13/12; F24F 13/14;
F24F 13/15; F24F 13/16; F24F 13/18;
F24F 13/20; B08B 15/007; E04F 17/026;
C23C 16/4408; C23C 16/4409; C23C
16/4583
See application file for complete search history.

D142,841 S	11/1945	D'Algodt
2,410,420 A	11/1946	Bennett
2,441,253 A	5/1948	Sarver
2,480,557 A	8/1949	Cummins
2,563,931 A	8/1951	Harrison
2,660,061 A	11/1953	Lewis
2,745,640 A	5/1956	Cushman
2,847,320 A	8/1958	Bulloff

(Continued)

FOREIGN PATENT DOCUMENTS

AT	520629	6/2019
CN	1186873	7/1998

(Continued)

OTHER PUBLICATIONS

Exhaust V Band Clamp, Jul. 12, 2017, Amazon, site visited Nov. 15, 2021: <https://www.amazon.com/dp/B073WTNXVQ/> (Year: 2017).*

(Continued)

Primary Examiner — Jack Reickel
Assistant Examiner — Bobby W Jones, II
(74) *Attorney, Agent, or Firm* — Snell & Wilmer L.L.P.

(57) **CLAIM**

The ornamental design for an exhaust duct, as shown and described.

DESCRIPTION

FIG. 1 is a top perspective view of an exhaust duct showing our new design;
FIG. 2 is a bottom perspective view thereof;
FIG. 3 is a top plan view thereof;
FIG. 4 is a bottom plan view thereof;
FIG. 5 is a front elevational view thereof;
FIG. 6 is a rear elevational view thereof;
FIG. 7 is a right side elevational view thereof;
FIG. 8 is a left side elevational view thereof; and,
FIG. 9 is a cross-sectional view thereof.

1 Claim, 7 Drawing Sheets

- (56) **References Cited**
U.S. PATENT DOCUMENTS
- | | | |
|-------------|---------|-----------------|
| D30,036 S | 1/1899 | Rhind |
| D31,889 S | 11/1899 | Gill |
| D56,051 S | 8/1920 | Cohn |
| 2,059,480 A | 11/1936 | Obermaier |
| 2,161,626 A | 6/1939 | Loughner et al. |
| 2,240,163 A | 4/1941 | Pick |
| 2,266,416 A | 12/1941 | Duclos |
| 2,280,778 A | 4/1942 | Andersen |

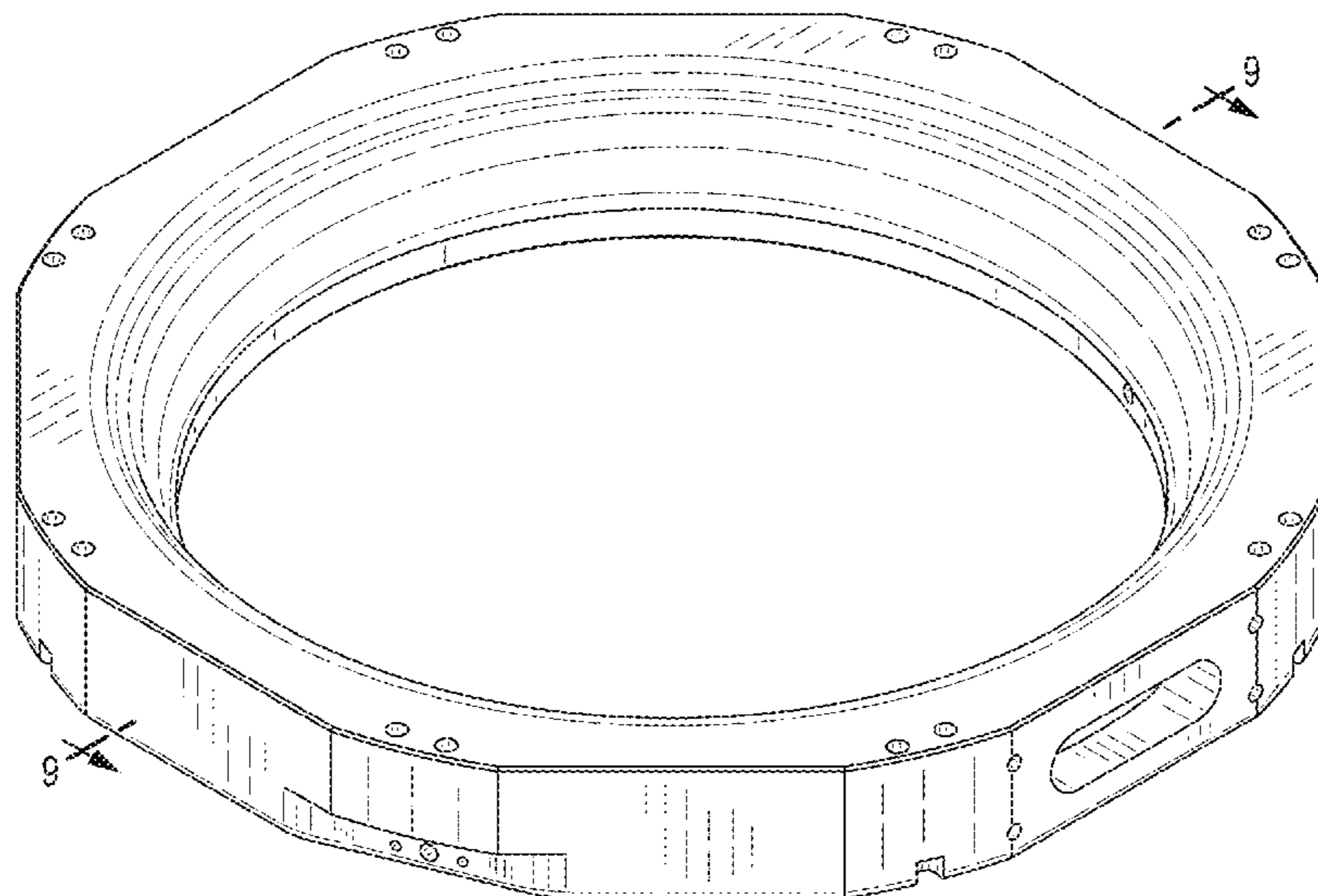

(56)

References Cited

U.S. PATENT DOCUMENTS

2,990,045 A	6/1961	Root	4,479,831 A	10/1984	Sandow
3,038,951 A	6/1962	Mead	4,480,284 A	10/1984	Tojo et al.
3,089,507 A	5/1963	Drake et al.	4,484,061 A	11/1984	Zelinka et al.
3,094,396 A	6/1963	Flugge et al.	4,488,506 A	12/1984	Heinecke et al.
3,197,682 A	7/1965	Klass et al.	4,495,024 A	1/1985	Bok
3,232,437 A	2/1966	Hultgren	4,496,828 A	1/1985	Kusmierz et al.
3,263,502 A	8/1966	Springfield	4,499,354 A	2/1985	Hill et al.
3,332,286 A	7/1967	Strong	4,502,094 A	2/1985	Lewin et al.
3,410,349 A	11/1968	Troutman	4,504,439 A	3/1985	Elter et al.
3,420,622 A	1/1969	Donges et al.	4,512,113 A	4/1985	Budinger
3,588,192 A	6/1971	Drutchas et al.	4,512,841 A	4/1985	Cunningham et al.
3,634,740 A	1/1972	Stevko	4,520,421 A	5/1985	Sakitani et al.
3,647,387 A	3/1972	Benson	4,527,005 A	7/1985	McKelvey et al.
3,647,716 A	3/1972	Koches	4,534,816 A	8/1985	Chen et al.
3,713,899 A	1/1973	Sebestyen	4,537,001 A	8/1985	Uppstrom
3,718,429 A	2/1973	Williamson	4,548,688 A	10/1985	Mathews
3,796,182 A	3/1974	Rosler	4,551,192 A	11/1985	Di Milia et al.
3,814,128 A	6/1974	Grantham	4,554,611 A	11/1985	Lewin
3,833,492 A	9/1974	Bollyky	4,560,590 A	12/1985	Bok
3,854,443 A	12/1974	Baerg	4,570,328 A	2/1986	Price et al.
3,862,397 A	1/1975	Anderson et al.	4,575,408 A	3/1986	Bok
3,867,205 A	2/1975	Schley	4,575,636 A	3/1986	Caprari
3,885,504 A	5/1975	Baermann	4,578,560 A	3/1986	Tanaka et al.
3,887,790 A	6/1975	Ferguson	4,579,080 A	4/1986	Martin et al.
3,904,371 A	9/1975	Neti	4,579,378 A	4/1986	Snyders
3,913,058 A	10/1975	Nishio et al.	4,579,623 A	4/1986	Suzuki et al.
3,913,617 A	10/1975	van Laar	4,581,520 A	4/1986	Vu et al.
3,916,270 A	10/1975	Wachtler et al.	4,590,326 A	5/1986	Woldy
3,947,685 A	3/1976	Meinel	4,611,966 A	9/1986	Johnson
3,960,559 A	6/1976	Suzuki	4,620,998 A	11/1986	Lalvani
3,962,004 A	6/1976	Sonneborn	4,622,918 A	11/1986	Bok
3,983,401 A	9/1976	Livesay	4,624,728 A	11/1986	Bithell et al.
3,997,638 A	12/1976	Manning et al.	D288,556 S	3/1987	Wallgren
4,048,110 A	9/1977	Vanderspurt	4,653,541 A	3/1987	Oehlschlaeger et al.
4,054,071 A	10/1977	Patejak	4,654,226 A	3/1987	Jackson et al.
4,058,430 A	11/1977	Suntola et al.	4,655,592 A	4/1987	Allemand
4,079,944 A	3/1978	Durley et al.	4,662,987 A	5/1987	Bok
4,093,491 A	6/1978	Whelpton et al.	4,664,769 A	5/1987	Cuomo et al.
4,099,041 A	7/1978	Berkman et al.	4,670,126 A	6/1987	Messer et al.
D249,341 S	9/1978	Mertz	4,681,134 A	7/1987	Paris
4,126,027 A	11/1978	Smith et al.	4,693,211 A	9/1987	Ogami et al.
4,134,425 A	1/1979	Gussefeld et al.	4,700,089 A	10/1987	Fujii et al.
4,145,699 A	3/1979	Hu et al.	4,707,815 A	11/1987	Yamasaki
4,149,237 A	4/1979	Freitas	4,717,461 A	1/1988	Strahl et al.
4,152,760 A	5/1979	Freitas et al.	4,718,637 A	1/1988	Contin
4,157,751 A	6/1979	Grundken et al.	4,720,407 A	1/1988	Sculke
4,164,959 A	8/1979	Wurzbarger	4,721,533 A	1/1988	Phillippi et al.
4,176,630 A	12/1979	Elmer	4,721,534 A	1/1988	Phillippi et al.
4,179,530 A	12/1979	Koppl et al.	4,722,298 A	2/1988	Rubin et al.
4,181,330 A	1/1980	Kojima	4,724,272 A	2/1988	Raniere et al.
4,184,188 A	1/1980	Briglia	4,725,204 A	2/1988	Powell
4,194,536 A	3/1980	Stine et al.	4,735,259 A	4/1988	Vincent
4,217,463 A	8/1980	Swearingen	4,738,618 A	4/1988	Massey et al.
4,229,064 A	10/1980	Vetter et al.	4,738,748 A	4/1988	Kisa
4,234,449 A	11/1980	Wolson et al.	4,747,367 A	5/1988	Posa
4,314,763 A	2/1982	Steigmeier et al.	4,749,416 A	6/1988	Greenspan
4,322,592 A	3/1982	Martin	4,750,520 A	6/1988	Heim et al.
4,324,611 A	4/1982	Vogel et al.	4,753,192 A	6/1988	Goldsmith et al.
4,333,735 A	6/1982	Hardy	4,753,856 A	6/1988	Haluska et al.
4,355,912 A	10/1982	Haak	4,756,794 A	7/1988	Yoder
4,384,918 A	5/1983	Abe	4,764,076 A	8/1988	Layman et al.
4,389,973 A	6/1983	Suntola et al.	4,770,590 A	9/1988	Hugues et al.
D269,850 S	7/1983	Preisler et al.	4,771,015 A	9/1988	Kanai
4,393,013 A	7/1983	McMenamin	4,775,281 A	10/1988	Prentakis
4,401,507 A	8/1983	Engle	4,776,744 A	10/1988	Stonestreet et al.
4,412,133 A	10/1983	Eckes et al.	4,780,169 A	10/1988	Stark et al.
4,413,022 A	11/1983	Suntola et al.	4,781,511 A	11/1988	Harada et al.
4,414,492 A	11/1983	Hanlet	4,789,294 A	12/1988	Sato et al.
4,436,674 A	3/1984	McMenamin	4,790,258 A	12/1988	Drage et al.
4,444,990 A	4/1984	Villar	4,802,441 A	2/1989	Waugh
D274,122 S	6/1984	Stahel et al.	4,808,387 A	2/1989	Datta et al.
4,454,370 A	6/1984	Voznick	4,812,201 A	3/1989	Sakai et al.
4,455,193 A	6/1984	Jeuch et al.	4,812,217 A	3/1989	George et al.
4,465,716 A	8/1984	Baber et al.	4,821,674 A	4/1989	deBoer et al.
4,466,766 A	8/1984	Geren et al.	4,827,430 A	5/1989	Aid et al.
			4,828,224 A	5/1989	Crabb et al.
			4,830,515 A	5/1989	Cortes
			4,837,113 A *	6/1989	Luttmer C23C 16/306

(56)

References Cited

U.S. PATENT DOCUMENTS

4,837,185 A	6/1989	Yau et al.	5,154,301 A	10/1992	Kos
4,854,263 A	8/1989	Chang et al.	5,158,128 A	10/1992	Inoue et al.
4,854,266 A	8/1989	Simson et al.	D330,900 S	11/1992	Wakegijig
4,857,137 A	8/1989	Tachi et al.	5,167,716 A	12/1992	Boitnott et al.
4,857,382 A	8/1989	Liu et al.	5,167,761 A	12/1992	Westendorp et al.
4,858,557 A	8/1989	Pozzetti et al.	5,174,881 A	12/1992	Iwasaki et al.
4,863,374 A	9/1989	Vukovich	5,176,451 A	1/1993	Sasada
4,867,629 A	9/1989	Iwasawa et al.	5,178,639 A	1/1993	Nishi
4,871,523 A	10/1989	Datta et al.	5,178,682 A	1/1993	Tsukamoto et al.
4,874,273 A	10/1989	Tokisue et al.	5,180,273 A	1/1993	Sakaya et al.
4,882,199 A	11/1989	Sadoway et al.	5,180,435 A	1/1993	Markunas et al.
4,886,162 A	12/1989	Ambrogio	5,181,779 A	1/1993	Shia et al.
4,916,091 A	4/1990	Freeman et al.	5,182,232 A	1/1993	Chhabra et al.
4,917,556 A	4/1990	Stark et al.	5,183,511 A	2/1993	Yamazaki et al.
4,920,918 A	5/1990	Adams et al.	D333,606 S	3/1993	Kanemitsu et al.
4,925,388 A	5/1990	Iseki et al.	5,192,717 A	3/1993	Kawakami
4,931,135 A	6/1990	Horiuchi et al.	5,193,912 A	3/1993	Saunders
4,934,831 A	6/1990	Volbrecht	5,193,969 A	3/1993	Rush et al.
4,938,815 A	7/1990	McNeilly	5,194,401 A	3/1993	Adams et al.
D309,702 S	8/1990	Hall	5,199,603 A	4/1993	Prescott
4,949,848 A	8/1990	Kos	5,208,961 A	5/1993	Lajoie
4,950,624 A	8/1990	Inuzima et al.	5,213,650 A	5/1993	Wang et al.
4,956,538 A	9/1990	Moslehi	5,221,556 A	6/1993	Hawkins et al.
4,958,061 A	9/1990	Wakabayashi et al.	5,225,366 A	7/1993	Yoder
D311,126 S	10/1990	Crowley	5,226,383 A	7/1993	Bhat
4,962,063 A	10/1990	Maydan et al.	5,226,713 A	7/1993	Matsumura
4,976,996 A	12/1990	Monkowski et al.	5,226,967 A	7/1993	Chen et al.
4,978,567 A	12/1990	Miller	5,228,114 A	7/1993	Suzuki
4,984,904 A	1/1991	Nakano et al.	5,232,508 A	8/1993	Arena et al.
4,985,114 A	1/1991	Okudaira	5,234,526 A	8/1993	Chen et al.
4,986,215 A	1/1991	Yamada	5,242,501 A	9/1993	McDiarmid
4,987,102 A	1/1991	Nguyen et al.	5,242,539 A	9/1993	Kumihashi et al.
4,987,856 A	1/1991	Hey	5,243,195 A	9/1993	Nishi
4,989,992 A	2/1991	Piai	5,243,202 A	9/1993	Mori et al.
4,991,614 A	2/1991	Hammel	5,246,218 A	9/1993	Yap et al.
5,002,632 A	3/1991	Loewenstein et al.	5,246,500 A	9/1993	Samata et al.
5,013,691 A	5/1991	Lory et al.	5,249,960 A	10/1993	Monoe
5,022,961 A	6/1991	Izumi et al.	5,259,881 A	11/1993	Edwards et al.
5,027,746 A	7/1991	Frijlink	5,261,167 A	11/1993	Sakata
5,028,366 A	7/1991	Harakal et al.	5,266,526 A	11/1993	Aoyama
D320,148 S	9/1991	Andrews	5,268,989 A	12/1993	Moslehi et al.
5,049,029 A	9/1991	Mitsui et al.	5,271,967 A	12/1993	Kramer et al.
5,053,247 A	10/1991	Moore	5,273,609 A	12/1993	Moslehi
5,057,436 A	10/1991	Ball	5,277,932 A	1/1994	Spencer
5,060,322 A	10/1991	Delepine	5,278,494 A	1/1994	Obigane
5,061,083 A	10/1991	Grimm et al.	5,279,886 A	1/1994	Kawai et al.
5,062,386 A	11/1991	Christensen	5,279,986 A	1/1994	Maloney et al.
5,064,337 A	11/1991	Asakawa et al.	5,280,894 A	1/1994	Witcraft et al.
5,065,698 A	11/1991	Koike	5,281,274 A	1/1994	Yoder
5,067,437 A	11/1991	Watanabe et al.	5,284,519 A	2/1994	Gadgil
5,069,591 A	12/1991	Kinoshita	5,288,684 A	2/1994	Yamazaki et al.
5,071,258 A	12/1991	Usher et al.	5,294,572 A	3/1994	Granneman et al.
5,074,017 A	12/1991	Toya et al.	5,294,778 A	3/1994	Carman et al.
5,082,517 A	1/1992	Moslehi	5,298,089 A	3/1994	Bowe et al.
5,084,126 A	1/1992	McKee	D346,433 S *	4/1994	Cooper D23/259
5,088,444 A	2/1992	Ohmine et al.	5,305,417 A	4/1994	Najm et al.
5,097,890 A	3/1992	Nakao	5,306,666 A	4/1994	Izumi
5,098,638 A	3/1992	Sawada	5,306,946 A	4/1994	Yamamoto
5,098,865 A	3/1992	Machado	5,308,650 A	5/1994	Krummel et al.
5,104,514 A	4/1992	Quartarone	5,310,410 A	5/1994	Begin et al.
5,107,170 A	4/1992	Ishikawa et al.	5,310,456 A	5/1994	Kadomura
5,108,192 A	4/1992	Mailliet et al.	5,312,245 A	5/1994	Brannen et al.
5,110,407 A	5/1992	Ono et al.	5,313,061 A	5/1994	Drew et al.
5,114,683 A	5/1992	Hirase	5,314,538 A	5/1994	Maeda et al.
5,116,018 A	5/1992	Friemoth et al.	5,314,570 A	5/1994	Ikegaya et al.
5,117,121 A	5/1992	Watanabe et al.	5,315,092 A	5/1994	Takahashi et al.
D327,534 S	6/1992	Manville	5,320,218 A	6/1994	Yamashita et al.
5,119,760 A	6/1992	McMillan et al.	5,326,427 A	7/1994	Jerbic
5,124,272 A	6/1992	Saito et al.	5,328,810 A	7/1994	Lowrey et al.
5,125,358 A	6/1992	Ueda et al.	5,335,309 A	8/1994	Fujii et al.
5,125,710 A	6/1992	Gianelo	5,336,327 A	8/1994	Lee
5,130,003 A	7/1992	Conrad	5,338,362 A	8/1994	Imahashi
5,134,965 A	8/1992	Tokuda et al.	5,340,261 A	8/1994	Oosawa et al.
5,137,286 A	8/1992	Whitford	5,346,961 A	9/1994	Shaw et al.
5,151,296 A	9/1992	Tokunaga	5,348,774 A	9/1994	Golecki et al.
			5,350,480 A	9/1994	Gray
			5,354,433 A	10/1994	Granneman et al.
			5,354,580 A	10/1994	Goela et al.
			5,356,478 A	10/1994	Chen et al.

(56)

References Cited

U.S. PATENT DOCUMENTS

5,356,672 A	10/1994	Schmitt et al.	5,576,629 A	11/1996	Turner
5,360,269 A	11/1994	Ogawa et al.	5,577,331 A	11/1996	Suzuki
5,364,667 A	11/1994	Rhieu	5,583,736 A	12/1996	Anderson et al.
D353,452 S	12/1994	Groenhoff	5,584,936 A	12/1996	Pickering et al.
5,374,315 A	12/1994	Deboer et al.	5,586,585 A	12/1996	Bonora et al.
D354,898 S	1/1995	Nagy	5,589,002 A	12/1996	Su
5,380,367 A	1/1995	Bertone	5,589,110 A	12/1996	Motoda et al.
5,382,311 A	1/1995	Ishikawa et al.	5,595,606 A	1/1997	Fujikawa et al.
5,387,265 A	2/1995	Kakizaki et al.	5,601,641 A	2/1997	Stephens
5,388,945 A	2/1995	Garric et al.	5,602,060 A	2/1997	Kobayashi et al.
5,393,577 A	2/1995	Uesugi et al.	5,604,410 A	2/1997	Vollkommer et al.
5,397,395 A	3/1995	Sano et al.	5,611,448 A	3/1997	Chen
5,403,630 A	4/1995	Matsui et al.	5,616,264 A	4/1997	Nishi et al.
5,404,082 A	4/1995	Hernandez et al.	5,616,947 A	4/1997	Tamura
5,407,449 A	4/1995	Zinger	5,621,982 A	4/1997	Yamashita
5,407,867 A	4/1995	Iwasaki et al.	5,632,919 A	5/1997	MacCracken et al.
5,413,813 A	5/1995	Cruse et al.	D380,527 S	7/1997	Velez
5,414,221 A	5/1995	Gardner	5,645,646 A	7/1997	Beinglass et al.
5,415,753 A	5/1995	Hurwitt et al.	5,650,013 A	7/1997	Yamazaki
5,418,382 A	5/1995	Blackwood et al.	5,650,351 A	7/1997	Wu
5,421,893 A	6/1995	Perlov	5,653,807 A	8/1997	Crumbaker
5,422,139 A	6/1995	Fischer	5,656,093 A	8/1997	Burkhart et al.
5,423,942 A	6/1995	Robbins et al.	5,661,263 A	8/1997	Salvaggio
5,426,137 A	6/1995	Allen	5,662,470 A	9/1997	Huussen et al.
5,427,824 A	6/1995	Inushima et al.	5,663,899 A	9/1997	Zvonar et al.
5,430,011 A	7/1995	Tanaka et al.	5,665,608 A	9/1997	Chapple-Sokol et al.
5,431,734 A	7/1995	Chapple-Sokol et al.	5,667,592 A	9/1997	Boitnott et al.
5,443,646 A	8/1995	Yamada et al.	5,670,786 A	9/1997	Meyer et al.
5,443,648 A	8/1995	Ohkase	5,679,215 A	10/1997	Barnes et al.
5,443,686 A	8/1995	Jones et al.	5,681,779 A	10/1997	Pasch et al.
5,444,217 A	8/1995	Moore	D386,076 S	11/1997	Moore
5,447,294 A	9/1995	Sakata et al.	5,683,517 A	11/1997	Shan
5,453,124 A	9/1995	Moslehi et al.	5,685,912 A	11/1997	Nishizaka
D363,464 S	10/1995	Fukasawa	5,685,914 A	11/1997	Hills et al.
5,456,207 A	10/1995	Gedridge et al.	5,690,742 A	11/1997	Ogata et al.
5,456,757 A	10/1995	Aruga et al.	5,695,567 A	12/1997	Kordina
5,461,214 A	10/1995	Peck et al.	5,697,706 A	12/1997	Ciaravino et al.
5,462,899 A	10/1995	Ikeda	5,698,036 A	12/1997	Ishii et al.
5,463,176 A	10/1995	Eckert	5,700,729 A	12/1997	Lee et al.
5,464,313 A	11/1995	Ohsawa	5,708,825 A	1/1998	Sotomayor
5,474,410 A	12/1995	Ozawa et al.	5,709,745 A	1/1998	Larkin et al.
5,474,612 A	12/1995	Sato et al.	5,711,811 A	1/1998	Suntola et al.
5,480,488 A	1/1996	Bittner et al.	5,716,133 A	2/1998	Hosokawa et al.
5,480,818 A	1/1996	Matsumoto et al.	5,718,574 A	2/1998	Shimazu
5,482,559 A	1/1996	Imai et al.	5,720,927 A	2/1998	Cripe et al.
5,484,484 A	1/1996	Yamaga et al.	D392,855 S	3/1998	Pillow
5,494,439 A	2/1996	Goldstein et al.	5,724,748 A	3/1998	Brooks
5,494,494 A	2/1996	Mizuno et al.	5,728,223 A	3/1998	Murakami et al.
5,496,408 A	3/1996	Motoda et al.	5,728,425 A	3/1998	Ebe et al.
5,501,740 A	3/1996	Besen et al.	5,730,801 A	3/1998	Tepman et al.
5,503,875 A	4/1996	Imai et al.	5,730,802 A	3/1998	Ishizumi et al.
5,504,042 A	4/1996	Cho et al.	5,732,597 A	3/1998	Devenyi
5,510,277 A	4/1996	Cunningham et al.	5,732,744 A	3/1998	Barr et al.
5,512,102 A	4/1996	Yamazaki	5,736,314 A	4/1998	Hayes et al.
5,514,439 A	5/1996	Sibley	5,753,835 A	5/1998	Gustin
5,518,549 A	5/1996	Hellwig	5,754,390 A	5/1998	Sandhu et al.
5,519,234 A	5/1996	Paz de Araujo	5,759,281 A	6/1998	Gurary et al.
5,520,743 A	5/1996	Takahashi et al.	5,761,328 A	6/1998	Solberg et al.
5,523,616 A	6/1996	Yasuhide	5,766,365 A	6/1998	Umutoy et al.
5,527,111 A	6/1996	Lysen et al.	5,768,125 A	6/1998	Zinger et al.
5,527,417 A	6/1996	Iida et al.	5,769,952 A	6/1998	Komino
5,531,218 A	7/1996	Krebs	5,775,889 A	7/1998	Kobayashi et al.
5,531,835 A	7/1996	Fodor et al.	5,777,838 A	7/1998	Tamagawa et al.
5,537,311 A	7/1996	Stevens	5,779,203 A	7/1998	Edlinger
5,540,059 A	7/1996	Yokokawa	5,781,693 A	7/1998	Ballance et al.
5,540,898 A	7/1996	Davidson	5,782,979 A	7/1998	Kaneno
5,554,557 A	9/1996	Koh	5,790,750 A	8/1998	Anderson
5,556,275 A	9/1996	Sakata et al.	5,791,782 A	8/1998	Wooten et al.
5,558,717 A	9/1996	Zhao et al.	5,792,272 A *	8/1998	van Os H01J 37/32862 118/723 R
5,559,046 A	9/1996	Oishi et al.	5,796,074 A	8/1998	Edelstein et al.
5,562,383 A	10/1996	Iwai et al.	5,801,104 A	9/1998	Schuegraf et al.
5,562,947 A	10/1996	White et al.	5,801,945 A	9/1998	Comer
5,562,952 A	10/1996	Nakahigashi et al.	5,806,980 A	9/1998	Berrian
5,569,402 A	10/1996	Meisser et al.	5,813,851 A	9/1998	Nakao
5,574,247 A	11/1996	Nishitani et al.	5,818,716 A	10/1998	Chin et al.
			5,819,092 A	10/1998	Ferguson et al.
			5,819,434 A	10/1998	Herchen et al.
			5,820,366 A	10/1998	Lee

(56)

References Cited

U.S. PATENT DOCUMENTS

5,820,685 A	10/1998	Kurihira et al.	5,997,768 A	12/1999	Scully
5,820,686 A	10/1998	Moore	5,998,870 A	12/1999	Lee et al.
5,826,129 A	10/1998	Hasebe et al.	6,000,732 A	12/1999	Scheler et al.
5,827,420 A	10/1998	Shirazi et al.	6,001,183 A	12/1999	Gurary et al.
5,827,435 A	10/1998	Samukawa	6,001,267 A	12/1999	Van Os et al.
5,827,757 A	10/1998	Robinson, Jr. et al.	6,004,204 A	12/1999	Luxton et al.
5,836,483 A	11/1998	Disel	D419,652 S	1/2000	Hall et al.
5,837,058 A	11/1998	Chen et al.	6,013,553 A	1/2000	Wallace
5,837,320 A	11/1998	Hampden-Smith et al.	6,013,920 A	1/2000	Gordon et al.
5,844,683 A	12/1998	Pavloski et al.	6,014,677 A	1/2000	Hayashi et al.
5,846,332 A	12/1998	Zhao et al.	6,015,459 A	1/2000	Jamison et al.
5,851,294 A	12/1998	Young et al.	6,015,465 A	1/2000	Kholodenko et al.
5,851,299 A	12/1998	Cheng et al.	6,017,779 A	1/2000	Miyasaka
5,852,445 A	12/1998	Yoshikawa et al.	6,017,818 A	1/2000	Lu
5,852,879 A	12/1998	Schumaier	6,022,180 A	2/2000	Motoyama et al.
5,853,484 A	12/1998	Jeong	6,022,802 A	2/2000	Jang
D403,949 S	1/1999	Nakamura	6,024,799 A *	2/2000	Chen C23C 16/455
D404,370 S	1/1999	Kimura			118/715
D404,372 S	1/1999	Ishii	6,025,117 A	2/2000	Nakano et al.
5,855,680 A	1/1999	Soininen et al.	6,027,163 A	2/2000	Longenecker et al.
5,855,681 A	1/1999	Maydan et al.	6,029,602 A	2/2000	Bhatnagar
5,855,687 A	1/1999	DuBois et al.	6,030,900 A	2/2000	Grassl et al.
5,855,726 A	1/1999	Soraoka et al.	6,033,215 A	3/2000	Ohsawa
5,857,777 A	1/1999	Schuh	6,035,101 A	3/2000	Sajoto et al.
5,861,233 A	1/1999	Sekine et al.	6,035,804 A	3/2000	Arami et al.
5,862,302 A	1/1999	Okase	6,039,809 A	3/2000	Toyama et al.
5,863,123 A	1/1999	Lee et al.	6,042,652 A	3/2000	Hyun
5,865,205 A	2/1999	Wilmer	6,044,860 A	4/2000	Neu
5,866,795 A	2/1999	Wang et al.	6,045,260 A	4/2000	Schwartz et al.
5,871,586 A	2/1999	Crawley et al.	6,048,154 A	4/2000	Wytman
5,872,065 A	2/1999	Sivaramakrishnan	6,050,506 A	4/2000	Guo et al.
5,873,942 A	2/1999	Park	6,053,982 A	4/2000	Halpin et al.
5,877,095 A	3/1999	Tamura et al.	6,053,983 A	4/2000	Saeki et al.
5,879,128 A	3/1999	Tietz et al.	6,054,013 A	4/2000	Collins et al.
5,879,459 A	3/1999	Gadgil et al.	6,054,678 A	4/2000	Miyazaki
5,880,980 A	3/1999	Rothacher et al.	6,060,691 A	5/2000	Minami et al.
5,882,165 A	3/1999	Maydan et al.	6,060,721 A	5/2000	Huang
5,884,640 A	3/1999	Fishkin et al.	6,063,196 A	5/2000	Li et al.
5,888,304 A	3/1999	Umotoy et al.	6,066,204 A	5/2000	Haven
5,891,251 A	4/1999	MacLeish et al.	6,068,441 A	5/2000	Raaijmakers et al.
5,893,741 A	4/1999	Huang	6,071,572 A	6/2000	Mosely et al.
5,897,348 A	4/1999	Wu	6,072,163 A	6/2000	Armstrong et al.
5,897,378 A	4/1999	Eriguchi	6,073,973 A	6/2000	Boscaljon et al.
5,897,379 A	4/1999	Ulrich et al.	6,074,154 A	6/2000	Ueda et al.
D409,894 S	5/1999	McClurg	6,074,443 A	6/2000	Venkatesh
5,904,170 A	5/1999	Harvey et al.	6,074,514 A	6/2000	Bjorkman et al.
D411,516 S	6/1999	Imafuku et al.	6,077,027 A	6/2000	Kawamura et al.
5,908,672 A	6/1999	Ryu	6,079,356 A	6/2000	Umotoy et al.
5,915,200 A	6/1999	Tokumasu et al.	6,079,927 A	6/2000	Muka
5,915,562 A	6/1999	Nyseth et al.	6,083,321 A	7/2000	Lei et al.
5,916,365 A	6/1999	Sherman	6,086,677 A	7/2000	Umotoy et al.
D412,270 S	7/1999	Fredrickson	6,090,212 A	7/2000	Mahawili
5,920,798 A	7/1999	Higuchi et al.	6,090,659 A	7/2000	Laibowitz et al.
5,928,426 A	7/1999	Aitchison	6,091,062 A	7/2000	Pfahnl et al.
D412,512 S	8/1999	Boisvert	6,093,252 A	7/2000	Wengert et al.
5,937,142 A	8/1999	Moslehi et al.	6,093,253 A	7/2000	Lofgren
5,937,323 A	8/1999	Orczyk et al.	6,095,083 A	8/2000	Rice et al.
5,939,886 A	8/1999	Turner et al.	6,096,133 A	8/2000	Yuuki et al.
5,947,718 A *	9/1999	Weaver H01L 21/67109 432/77	6,096,267 A	8/2000	Kishkovich
5,950,327 A	9/1999	Peterson et al.	6,099,302 A	8/2000	Hong et al.
5,950,925 A	9/1999	Fukunaga et al.	6,099,649 A	8/2000	Schmitt et al.
5,954,375 A	9/1999	Trickle et al.	6,099,651 A	8/2000	Sajoto et al.
5,961,775 A	10/1999	Fujimura	6,102,565 A	8/2000	Kita et al.
5,968,275 A	10/1999	Lee et al.	6,104,002 A	8/2000	Hirose et al.
5,970,621 A	10/1999	Bazydola	6,104,011 A	8/2000	Juliano
5,972,196 A	10/1999	Murphy et al.	6,104,401 A	8/2000	Parsons
5,975,492 A	11/1999	Brenes	6,106,625 A	8/2000	Koai et al.
5,979,506 A	11/1999	Aarseth	6,106,678 A	8/2000	Shufflebotham
5,982,931 A	11/1999	Ishimaru	6,110,531 A	8/2000	Paz de Araujo et al.
5,984,391 A	11/1999	Vanderpot et al.	6,113,703 A	9/2000	Anderson et al.
5,987,480 A	11/1999	Donohue et al.	6,119,710 A	9/2000	Brown
5,989,342 A	11/1999	Ikeda et al.	6,121,061 A	9/2000	Van Bilsen et al.
5,992,453 A	11/1999	Zimmer	6,121,158 A	9/2000	Benchikha et al.
5,997,588 A	12/1999	Goodwin	6,122,036 A	9/2000	Yamasaki et al.
			6,124,600 A	9/2000	Moroishi et al.
			6,125,789 A	10/2000	Gupta et al.
			6,126,744 A	10/2000	Hawkins et al.
			6,126,848 A	10/2000	Li et al.
			6,127,249 A	10/2000	Hu

(56)

References Cited

- U.S. PATENT DOCUMENTS
- 6,129,044 A 10/2000 Zhao et al.
6,129,546 A 10/2000 Sada
6,132,207 A 10/2000 Stoutjesdijk
6,134,807 A 10/2000 Komino
6,135,460 A 10/2000 Wise et al.
6,137,240 A 10/2000 Bogdan
6,139,239 A 10/2000 Snijders
6,140,252 A 10/2000 Cho et al.
6,143,079 A * 11/2000 Halpin C23C 16/4584
118/620
- 6,143,082 A 11/2000 McInerney et al.
6,146,463 A 11/2000 Yudovsky et al.
6,148,761 A 11/2000 Majewski et al.
6,151,446 A 11/2000 Hunter et al.
6,152,070 A 11/2000 Fairbairn et al.
6,156,151 A 12/2000 Komino et al.
6,158,941 A 12/2000 Muka et al.
6,160,244 A 12/2000 Ohashi
6,161,500 A 12/2000 Kopacz et al.
6,162,323 A 12/2000 Koshimizu
6,164,894 A 12/2000 Cheng
6,174,809 B1 1/2001 Kang et al.
6,176,929 B1 1/2001 Fukunaga et al.
6,178,918 B1 1/2001 Van Os et al.
6,179,955 B1 1/2001 Shin et al.
6,180,979 B1 1/2001 Hofman et al.
6,182,603 B1 2/2001 Shang et al.
6,183,564 B1 2/2001 Reynolds et al.
6,183,565 B1 2/2001 Granneman et al.
6,187,672 B1 2/2001 Zhao et al.
6,187,691 B1 2/2001 Fukuda
6,190,037 B1 2/2001 Das et al.
6,190,113 B1 2/2001 Bui et al.
6,190,634 B1 2/2001 Lieber et al.
6,191,399 B1 2/2001 Van Bilsen
6,194,037 B1 2/2001 Terasaki et al.
6,200,897 B1 3/2001 Wang et al.
6,201,999 B1 3/2001 Jevtic
6,203,613 B1 3/2001 Gates et al.
6,203,618 B1 3/2001 Hashizume et al.
6,207,932 B1 3/2001 Yoo
6,207,936 B1 3/2001 de Waard
6,209,221 B1 4/2001 Beulens
6,210,485 B1 4/2001 Zhao et al.
6,212,789 B1 4/2001 Kato
6,213,708 B1 4/2001 Allen
6,214,122 B1 4/2001 Thompson
6,214,717 B1 4/2001 Yan et al.
6,217,658 B1 4/2001 Orczyk et al.
6,217,662 B1 4/2001 Kong et al.
6,218,288 B1 4/2001 Li et al.
6,225,020 B1 5/2001 Jung et al.
6,225,602 B1 5/2001 Buiijze et al.
6,225,745 B1 5/2001 Srivastava
6,230,650 B1 5/2001 Yamazaki
6,231,290 B1 5/2001 Kikuchi et al.
6,235,858 B1 5/2001 Swarup et al.
6,238,734 B1 5/2001 Senzaki et al.
6,239,715 B1 5/2001 Belton
6,240,875 B1 6/2001 Wijck et al.
6,241,822 B1 6/2001 Ide
6,242,359 B1 6/2001 Misra
6,243,654 B1 6/2001 Johnson et al.
6,245,665 B1 6/2001 Yokoyama
6,247,245 B1 6/2001 Ishii
6,250,250 B1 6/2001 Maishev et al.
6,255,221 B1 7/2001 Hudson et al.
6,257,758 B1 7/2001 Culbertson
6,261,648 B1 7/2001 Akiba et al.
6,264,467 B1 7/2001 Lue et al.
6,265,113 B1 7/2001 Rosasco et al.
6,265,311 B1 7/2001 Hautala et al.
6,270,572 B1 8/2001 Kim et al.
6,271,148 B1 8/2001 Kao
6,271,320 B1 8/2001 Keller et al.
- 6,274,496 B1 8/2001 Leusink et al.
6,274,878 B1 8/2001 Li et al.
6,281,098 B1 8/2001 Wang
6,281,141 B1 8/2001 Das et al.
6,283,692 B1 9/2001 Perlov et al.
6,284,050 B1 9/2001 Shi et al.
6,284,149 B1 9/2001 Li et al.
6,287,965 B1 9/2001 Kang et al.
6,287,988 B1 9/2001 Nagamine et al.
6,293,700 B1 9/2001 Lund et al.
D449,873 S 10/2001 Bronson
6,296,710 B1 10/2001 Allen et al.
6,296,711 B1 10/2001 Loan et al.
6,296,909 B1 10/2001 Spitsberg
6,297,539 B1 10/2001 Ma et al.
6,299,133 B2 10/2001 Waragai et al.
6,302,964 B1 10/2001 Umotoy et al.
6,303,523 B2 10/2001 Cheung
6,305,898 B1 10/2001 Yamagishi et al.
6,311,016 B1 10/2001 Yanagawa et al.
6,312,525 B1 11/2001 Bright et al.
6,315,512 B1 11/2001 Tabrizi et al.
6,316,162 B1 11/2001 Jung et al.
6,316,371 B1 11/2001 Oosterlaken et al.
6,320,320 B1 11/2001 Bailey et al.
6,321,680 B2 11/2001 Cook et al.
6,321,780 B1 11/2001 Iwabuchi
D451,893 S 12/2001 Robson
D452,220 S 12/2001 Robson
6,325,858 B1 12/2001 Wengert
6,326,322 B1 12/2001 Kim et al.
6,326,597 B1 12/2001 Lubomirsky et al.
6,328,561 B1 12/2001 Hasper et al.
6,329,297 B1 12/2001 Balish
6,333,275 B1 12/2001 Mayer et al.
6,335,049 B1 1/2002 Basceri
6,335,240 B1 1/2002 Kim et al.
6,342,427 B1 1/2002 Choi et al.
6,343,239 B1 1/2002 Toda et al.
6,344,084 B1 2/2002 Koinuma et al.
6,344,232 B1 2/2002 Jones et al.
6,346,419 B1 2/2002 Ryerson et al.
6,347,636 B1 2/2002 Xia
6,350,391 B1 2/2002 Livshits et al.
6,352,049 B1 3/2002 Yin et al.
6,352,945 B1 3/2002 Matsuki
6,357,984 B1 3/2002 Zinger et al.
6,363,294 B1 3/2002 Coronel et al.
D455,024 S 4/2002 Mimick et al.
6,367,410 B1 4/2002 Leahey et al.
6,368,773 B1 4/2002 Jung et al.
6,368,987 B1 4/2002 Kopacz et al.
6,370,796 B1 4/2002 Zucker
6,372,583 B1 4/2002 Tyagi
6,374,831 B1 4/2002 Chandran
6,375,312 B1 4/2002 Ikeda et al.
6,375,749 B1 4/2002 Boydston et al.
6,375,750 B1 4/2002 Van Os et al.
6,379,466 B1 4/2002 Sahin et al.
D457,609 S 5/2002 Piano
6,383,300 B1 5/2002 Saito et al.
6,383,566 B1 5/2002 Zagdoun
6,383,955 B1 5/2002 Matsuki
6,387,207 B1 5/2002 Janakiraman
6,387,827 B1 5/2002 Mertens et al.
6,390,753 B1 5/2002 de Ridder et al.
6,390,754 B2 5/2002 Yamaga et al.
6,391,803 B1 5/2002 Kim et al.
6,395,650 B1 5/2002 Callegari et al.
6,398,184 B1 6/2002 Sowada et al.
6,399,022 B1 6/2002 Schuler et al.
6,402,806 B1 6/2002 Schmitt et al.
6,410,433 B1 6/2002 Hautala et al.
6,410,459 B2 6/2002 Blalock et al.
6,410,463 B1 6/2002 Matsuki
6,413,321 B1 7/2002 Kim et al.
6,413,583 B1 7/2002 Moghadam et al.
6,420,279 B1 7/2002 Ono et al.
6,423,949 B1 7/2002 Chen et al.

(56)

References Cited

U.S. PATENT DOCUMENTS

D461,233 S	8/2002	Whalen	6,528,752 B1	3/2003	Ishii et al.
D461,882 S	8/2002	Piano	6,528,767 B2	3/2003	Bagley et al.
6,428,859 B1	8/2002	Chiang et al.	6,530,994 B1	3/2003	Mahawili
6,429,465 B1	8/2002	Yagi et al.	6,531,193 B2	3/2003	Fonash et al.
6,432,206 B1	8/2002	Tolt	6,531,412 B2	3/2003	Conti et al.
6,432,255 B1	8/2002	Sun et al.	6,534,133 B1	3/2003	Kaloyeros et al.
6,432,479 B2	8/2002	Chang et al.	6,534,395 B2	3/2003	Werkhoven et al.
6,432,849 B1	8/2002	Endo et al.	6,536,950 B1	3/2003	Green
6,433,298 B1	8/2002	Ishii	6,539,891 B1	4/2003	Kang et al.
6,435,798 B1	8/2002	Satoh	6,540,469 B2	4/2003	Matsunaga et al.
6,435,865 B1	8/2002	Tseng et al.	6,540,838 B2	4/2003	Sneh et al.
6,436,819 B1	8/2002	Zhang	6,544,906 B2	4/2003	Rotondaro et al.
6,437,444 B2	8/2002	Andideh	6,552,209 B1	4/2003	Lei et al.
6,438,502 B1	8/2002	Awtrey	6,558,517 B2	5/2003	Basceri
6,439,822 B1	8/2002	Kimura et al.	6,558,755 B2	5/2003	Berry et al.
6,440,261 B1	8/2002	Tepman et al.	6,559,026 B1	5/2003	Rossman et al.
6,441,350 B1	8/2002	Stoddard et al.	6,562,094 B2	5/2003	Denker et al.
6,445,574 B1	9/2002	Saw et al.	6,565,763 B1	5/2003	Asakawa et al.
6,446,573 B2	9/2002	Hirayama et al.	6,566,278 B1	5/2003	Harvey et al.
6,447,232 B1	9/2002	Davis et al.	6,569,239 B2	5/2003	Arai et al.
6,447,651 B1	9/2002	Ishikawa et al.	6,569,971 B2	5/2003	Roh et al.
6,447,937 B1	9/2002	Murakawa et al.	6,573,030 B1	6/2003	Fairbairn et al.
6,448,192 B1	9/2002	Kaushik	6,574,644 B2	6/2003	Hsu et al.
6,450,117 B1	9/2002	Murugesh et al.	6,576,062 B2	6/2003	Matsuse
6,450,757 B1	9/2002	Saeki	6,576,064 B2	6/2003	Griffiths et al.
6,451,713 B1	9/2002	Tay et al.	6,576,300 B1	6/2003	Berry et al.
6,454,860 B2	9/2002	Metzner et al.	6,576,564 B2	6/2003	Agarwal
6,454,909 B1	9/2002	Matsuse et al.	6,578,589 B1	6/2003	Mayusumi
6,455,098 B2	9/2002	Tran et al.	6,579,833 B1	6/2003	McNallan et al.
6,455,225 B1	9/2002	Kong et al.	6,580,050 B1	6/2003	Miller et al.
6,455,445 B2	9/2002	Matsuki	6,582,174 B1	6/2003	Hayashi
6,460,482 B1	10/2002	Kuibira et al.	6,583,048 B1	6/2003	Vincent et al.
6,461,435 B1	10/2002	Littau et al.	6,583,572 B2	6/2003	Veltrop et al.
6,461,436 B1	10/2002	Campbell et al.	6,587,108 B1	7/2003	Guerlain et al.
6,461,439 B1	10/2002	Granneman et al.	6,589,352 B1	7/2003	Yudovsky et al.
6,468,924 B2	10/2002	Lee	6,589,707 B2	7/2003	Lee et al.
6,471,779 B1	10/2002	Nishio et al.	6,589,868 B2	7/2003	Rossman
6,472,266 B1	10/2002	Yu et al.	6,590,251 B2	7/2003	Kang et al.
6,474,987 B1	11/2002	Huang et al.	6,594,550 B1	7/2003	Okrah
6,475,276 B1	11/2002	Elers et al.	6,596,398 B1	7/2003	Russo et al.
6,475,902 B1	11/2002	Hausmann et al.	6,596,653 B2	7/2003	Tan
6,475,930 B1	11/2002	Junker et al.	6,598,559 B1	7/2003	Vellore et al.
6,478,872 B1	11/2002	Chae et al.	6,602,806 B1	8/2003	Xia et al.
6,481,945 B1	11/2002	Hasper et al.	6,607,602 B1	8/2003	Granneman et al.
6,482,331 B2	11/2002	Lu et al.	6,607,868 B2	8/2003	Choi
6,482,663 B1	11/2002	Buckland	6,607,948 B1	8/2003	Sugiyama et al.
6,483,989 B1	11/2002	Okada et al.	6,608,745 B2	8/2003	Tsuruta et al.
6,488,774 B1	12/2002	Horie et al.	6,610,375 B2	8/2003	Akiba et al.
6,490,493 B1	12/2002	Dharnipragada	6,613,685 B1	9/2003	Granneman et al.
6,492,625 B1	12/2002	Boguslavskiy et al.	6,616,986 B2	9/2003	Sherman
6,494,065 B2	12/2002	Babbitt	6,617,253 B1	9/2003	Chu et al.
6,494,998 B1	12/2002	Brcka	6,620,251 B2	9/2003	Kitano
6,496,819 B1	12/2002	Bello et al.	6,624,064 B1	9/2003	Sahin
6,497,734 B1	12/2002	Barber et al.	6,627,268 B1	9/2003	Fair et al.
6,497,767 B1	12/2002	Okase et al.	6,627,503 B2	9/2003	Ma et al.
6,498,091 B1	12/2002	Chen et al.	6,630,030 B1	10/2003	Suntola et al.
6,499,533 B2	12/2002	Yamada	6,632,478 B2	10/2003	Gaillard et al.
6,500,487 B1	12/2002	Holst et al.	6,633,364 B2	10/2003	Hayashi
6,502,530 B1	1/2003	Turlot et al.	6,635,115 B1	10/2003	Fairbairn et al.
6,503,079 B2	1/2003	Kogano et al.	6,635,117 B1	10/2003	Kinnard et al.
6,503,330 B1	1/2003	Sneh et al.	6,635,578 B1	10/2003	Xu et al.
6,503,365 B1	1/2003	Kim et al.	6,638,839 B2	10/2003	Deng et al.
6,503,562 B1	1/2003	Saito et al.	6,640,145 B2	10/2003	Hoffberg et al.
6,503,826 B1	1/2003	Oda	6,645,304 B2	11/2003	Yamaguchi
6,506,009 B1	1/2003	Nulman et al.	6,648,974 B1	11/2003	Ogliari et al.
6,506,253 B2	1/2003	Sakuma	6,649,921 B1	11/2003	Cekic et al.
6,507,410 B1	1/2003	Robertson et al.	6,652,924 B2	11/2003	Sherman
6,511,539 B1	1/2003	Raaijmakers	6,656,281 B1	12/2003	Ueda
6,514,313 B1	2/2003	Spiegelman	6,656,282 B2	12/2003	Kim et al.
6,514,666 B1	2/2003	Choi et al.	6,660,662 B2	12/2003	Ishikawa et al.
6,521,295 B1	2/2003	Remington	6,662,817 B2	12/2003	Yamagishi
6,521,547 B1	2/2003	Chang et al.	6,663,332 B1	12/2003	Sluijk et al.
6,527,884 B1	3/2003	Takakuwa et al.	6,673,196 B1	1/2004	Oyabu
6,528,171 B1	3/2003	Endler et al.	6,676,290 B1	1/2004	Lu
6,528,430 B2	3/2003	Kwan	6,676,759 B1	1/2004	Takagi
			6,679,194 B2	1/2004	Ham et al.
			6,682,971 B2	1/2004	Tsuneda et al.
			6,682,973 B1	1/2004	Paton et al.
			6,683,274 B1	1/2004	Kwon et al.

(56)

References Cited

U.S. PATENT DOCUMENTS

D486,891 S	2/2004	Cronce	6,847,014 B1	1/2005	Benjamin et al.
6,684,659 B1	2/2004	Tanaka et al.	6,849,241 B2	2/2005	Dauelsberg et al.
6,684,719 B2	2/2004	Gehner et al.	6,849,857 B2	2/2005	Ichiki et al.
6,686,281 B2	2/2004	Yamazaki et al.	6,854,580 B2	2/2005	Braford
6,688,784 B1	2/2004	Templeton	6,858,524 B2	2/2005	Haukka et al.
6,689,220 B1	2/2004	Nguyen	6,858,547 B2	2/2005	Metzner
6,692,575 B1	2/2004	Omstead et al.	6,861,642 B2	3/2005	Ichiki et al.
6,692,576 B2	2/2004	Halpin et al.	6,863,019 B2	3/2005	Shamouilian
6,696,367 B1	2/2004	Aggarwal	6,863,281 B2	3/2005	Endou et al.
6,699,003 B2	3/2004	Saeki	6,864,041 B2	3/2005	Brown
6,699,399 B1	3/2004	Qian et al.	6,867,086 B1	3/2005	Chen et al.
6,700,089 B1	3/2004	Hirooka	6,867,859 B1	3/2005	Powell
6,709,989 B2	3/2004	Ramdani et al.	6,872,258 B2	3/2005	Park et al.
6,710,364 B2	3/2004	Guldi et al.	6,872,259 B2	3/2005	Strang
6,710,857 B2	3/2004	Kondo	D504,142 S	4/2005	Horner-Richardson et al.
6,712,949 B2	3/2004	Gopal	6,874,247 B1	4/2005	Hsu
6,713,824 B1	3/2004	Mikata	6,874,480 B1	4/2005	Ismailov
6,715,949 B1	4/2004	Fisher et al.	6,875,477 B2	4/2005	Trickett et al.
6,716,571 B2	4/2004	Gabriel	6,875,677 B1	4/2005	Conley, Jr. et al.
6,719,499 B1	4/2004	Kuznetsov et al.	6,876,017 B2	4/2005	Goodner
6,720,260 B1	4/2004	Fair et al.	6,876,191 B2	4/2005	de Ridder
6,720,531 B1	4/2004	Jacobson et al.	6,878,206 B2	4/2005	Tzu et al.
6,722,837 B2	4/2004	Inui	6,878,402 B2	4/2005	Chiang et al.
6,723,642 B1	4/2004	Lim et al.	6,883,733 B1	4/2005	Lind
6,730,614 B1	5/2004	Lim et al.	6,884,066 B2	4/2005	Nguyen et al.
6,732,006 B2	5/2004	Haanstra et al.	6,884,295 B2	4/2005	Ishii
6,734,090 B2	5/2004	Agarwala et al.	6,884,319 B2	4/2005	Kim
6,734,631 B2	5/2004	Juestel et al.	6,884,475 B2	4/2005	Basceri
6,737,716 B1	5/2004	Matsuo et al.	D505,590 S	5/2005	Greiner
6,740,853 B1	5/2004	Johnson et al.	6,889,211 B1	5/2005	Yoshiura et al.
6,743,475 B2	6/2004	Skarp et al.	6,889,864 B2	5/2005	Lindfors et al.
6,743,738 B2	6/2004	Todd et al.	6,890,596 B2	5/2005	Sarigiannis et al.
6,745,095 B1	6/2004	Ben-Dov	6,895,158 B2	5/2005	Alyward et al.
6,746,240 B2	6/2004	de Ridder et al.	6,899,507 B2	5/2005	Yamagishi et al.
6,746,308 B1	6/2004	Bode et al.	6,902,395 B2	6/2005	Oosterlaken et al.
6,749,671 B2	6/2004	Holst et al.	6,909,839 B2	6/2005	Wang et al.
6,753,507 B2	6/2004	Fure et al.	6,911,092 B2	6/2005	Sneh
6,755,221 B2	6/2004	Jeong et al.	6,913,152 B2	7/2005	Zuk
6,756,085 B2	6/2004	Waldfried	6,913,796 B2	7/2005	Albano et al.
6,756,293 B2	6/2004	Li et al.	6,916,398 B2	7/2005	Chen et al.
6,756,318 B2	6/2004	Nguyen et al.	6,916,559 B2	7/2005	Murakawa et al.
6,759,098 B2	7/2004	Han	6,917,755 B2	7/2005	Nguyen et al.
6,760,981 B2	7/2004	Leap	6,924,078 B2	8/2005	Lee et al.
6,767,447 B2	7/2004	Uno et al.	6,928,890 B2	8/2005	Gehner et al.
D494,552 S	8/2004	Tezuka et al.	6,929,699 B2	8/2005	Whitesell
6,776,849 B2	8/2004	Aggarwal et al.	6,929,700 B2	8/2005	Tan et al.
6,780,704 B1	8/2004	Raaijmakers et al.	6,930,041 B2	8/2005	Agarwal
6,783,875 B2	8/2004	Yamada et al.	6,930,059 B2	8/2005	Conley, Jr. et al.
6,784,033 B1	8/2004	Yamazaki	6,935,269 B2	8/2005	Lee et al.
6,784,108 B1	8/2004	Donohoe et al.	6,939,579 B2	9/2005	Bondestam et al.
D496,008 S	9/2004	Takahashi et al.	6,939,817 B2	9/2005	Sandhu et al.
6,786,997 B1	9/2004	Yamazaki	6,942,753 B2	9/2005	Choi et al.
D497,536 S	10/2004	Fujiwara	6,949,204 B1	9/2005	Lenz et al.
D497,977 S	11/2004	Engelbrektsson	6,951,587 B1	10/2005	Narushima
6,811,960 B2	11/2004	Lee et al.	6,952,656 B1	10/2005	Cordova et al.
6,812,157 B1	11/2004	Gadgil	6,953,609 B2	10/2005	Carollo
6,815,350 B2	11/2004	Kim et al.	6,955,741 B2	10/2005	Yamagishi
6,815,352 B1	11/2004	Tamura et al.	6,955,836 B2	10/2005	Kumagai et al.
6,818,864 B2	11/2004	Ptak	6,955,928 B1	10/2005	Brennan
6,820,570 B2	11/2004	Kilpela et al.	6,963,052 B2	11/2005	Kuibira et al.
6,821,910 B2	11/2004	Adomaitis et al.	6,972,055 B2	12/2005	Sferlazzo
6,824,665 B2	11/2004	Shelnut et al.	6,972,478 B1	12/2005	Waite et al.
6,825,134 B2	11/2004	Law et al.	6,974,781 B2	12/2005	Timmermans et al.
D499,620 S	12/2004	Horner-Richardson et al.	6,975,921 B2	12/2005	Verhaar
6,827,789 B2	12/2004	Lee et al.	6,976,822 B2	12/2005	Woodruff
6,828,235 B2	12/2004	Takano	RE38,937 E	1/2006	Nakamura
6,831,004 B2	12/2004	Byun	6,981,832 B2	1/2006	Zinger et al.
6,833,024 B2	12/2004	Holst et al.	6,982,046 B2	1/2006	Srivastava et al.
6,835,039 B2	12/2004	Van Den Berg	6,982,103 B2	1/2006	Basceri et al.
6,838,122 B2	1/2005	Basceri et al.	6,984,591 B1	1/2006	Buchanan et al.
6,841,201 B2	1/2005	Shanov et al.	6,984,595 B1	1/2006	Yamazaki
6,843,202 B2	1/2005	Kusuda	6,985,788 B2	1/2006	Haanstra et al.
6,846,146 B2	1/2005	Inui	6,986,914 B2	1/2006	Elers et al.
6,846,515 B2	1/2005	Vrtis	6,987,155 B2	1/2006	Roh et al.
6,846,742 B2	1/2005	Rossman	6,990,430 B2	1/2006	Hosek
			7,005,227 B2	2/2006	Yueh et al.
			7,005,391 B2	2/2006	Min
			7,008,879 B2	3/2006	Lee et al.
			7,010,580 B1	3/2006	Fu et al.

(56)

References Cited

U.S. PATENT DOCUMENTS

7,017,514 B1	3/2006	Shepherd et al.	7,207,763 B2	4/2007	Lee
7,018,941 B2	3/2006	Cui et al.	7,208,198 B2	4/2007	Basceri et al.
7,021,330 B2	4/2006	Maula et al.	7,208,389 B1	4/2007	Tipton et al.
7,021,881 B2	4/2006	Yamagishi	7,210,925 B2	5/2007	Adachi
7,036,453 B2	5/2006	Ishikawa et al.	7,211,524 B2	5/2007	Ryu et al.
7,041,609 B2	5/2006	Vaartstra	7,211,525 B1	5/2007	Shanker
7,045,430 B2	5/2006	Ahn et al.	7,214,630 B1	5/2007	Varadarajan et al.
7,049,226 B2	5/2006	Chung et al.	7,217,617 B2	5/2007	Basceri
7,049,247 B2	5/2006	Gates et al.	7,223,014 B2	5/2007	Lojen
7,052,584 B2	5/2006	Basceri	7,208,413 B2	6/2007	Byun et al.
7,053,009 B2	5/2006	Conley, Jr. et al.	7,234,476 B2	6/2007	Arai
7,055,263 B2	6/2006	Wu et al.	7,235,137 B2	6/2007	Kitayama et al.
7,055,875 B2	6/2006	Bonora	7,235,482 B2	6/2007	Wu
7,062,161 B2	6/2006	Kusuda et al.	7,235,501 B2	6/2007	Ahn et al.
D524,600 S	7/2006	Austin et al.	7,238,596 B2	7/2007	Kouvetakis et al.
D525,127 S	7/2006	Cogley et al.	7,238,616 B2	7/2007	Agarwal
7,070,178 B2	7/2006	Van Der Toorn et al.	7,238,653 B2	7/2007	Lee et al.
7,071,051 B1	7/2006	Jeon et al.	D549,815 S	8/2007	Murphy
7,073,834 B2	7/2006	Matsumoto et al.	7,256,375 B2	8/2007	Oosterlaken
7,074,690 B1	7/2006	Gauri et al.	7,265,061 B1	9/2007	Cho et al.
7,077,614 B1	7/2006	Hasper et al.	7,274,867 B2	9/2007	Peukert
7,080,545 B2	7/2006	Dimeo et al.	D553,104 S	10/2007	Oohashi et al.
7,084,060 B1	8/2006	Furukawa	7,279,256 B2	10/2007	Son
7,084,079 B2	8/2006	Conti et al.	7,290,813 B2	11/2007	Bonora
7,085,623 B2	8/2006	Siegers	7,294,581 B2	11/2007	Haverkort et al.
7,086,347 B2	8/2006	Howald et al.	7,296,460 B2	11/2007	Dimeo et al.
7,088,003 B2	8/2006	Gates et al.	7,297,641 B2	11/2007	Todd et al.
7,090,394 B2	8/2006	Hashikura et al.	7,298,009 B2	11/2007	Yan et al.
7,092,287 B2	8/2006	Beulens et al.	7,301,623 B1	11/2007	Madsen et al.
7,098,149 B2	8/2006	Lukas	D556,704 S	12/2007	Nakamura et al.
7,098,150 B2	8/2006	Misra et al.	D557,226 S	12/2007	Uchino et al.
7,100,459 B2	9/2006	Gehner et al.	D558,021 S	12/2007	Lawrence
7,101,763 B1	9/2006	Anderson et al.	7,307,028 B2	12/2007	Goto et al.
7,108,753 B2	9/2006	Wood	7,307,178 B2	12/2007	Kiyomori et al.
7,109,098 B1	9/2006	Ramaswamy et al.	7,312,148 B2	12/2007	Ramaswamy et al.
7,109,114 B2	9/2006	Chen et al.	7,312,162 B2	12/2007	Ramaswamy et al.
7,111,232 B1	9/2006	Bascom	7,312,494 B2	12/2007	Ahn et al.
7,115,305 B2	10/2006	Bronikowski et al.	D559,993 S	1/2008	Nagakubo et al.
7,115,838 B2	10/2006	Kurara et al.	D559,994 S	1/2008	Nagakubo et al.
7,122,085 B2	10/2006	Shero et al.	7,320,544 B2	1/2008	Hsieh
7,122,222 B2	10/2006	Xiao et al.	7,323,401 B2	1/2008	Ramaswamy et al.
7,122,844 B2	10/2006	Nakamura et al.	D562,357 S	2/2008	Hardy
7,129,165 B2	10/2006	Basol et al.	7,326,656 B2	2/2008	Brask et al.
7,132,360 B2	11/2006	Schaeffer et al.	7,326,657 B2	2/2008	Xia et al.
7,135,421 B2	11/2006	Ahn et al.	7,327,948 B1	2/2008	Shrinivasan
7,140,558 B2	11/2006	McCracken et al.	7,329,947 B2	2/2008	Adachi et al.
7,141,499 B2	11/2006	Raaijmakers	7,335,611 B2	2/2008	Ramaswamy et al.
7,143,897 B1	12/2006	Guzman et al.	7,351,057 B2	4/2008	Berenbak et al.
7,144,809 B2	12/2006	Elers et al.	7,354,482 B2	4/2008	Konishi et al.
7,147,766 B2	12/2006	Uzoh et al.	7,354,847 B2	4/2008	Chan et al.
7,153,542 B2	12/2006	Nguyen et al.	7,354,873 B2	4/2008	Fukazawa et al.
D535,673 S	1/2007	Conway et al.	7,356,762 B2	4/2008	van Driel
7,156,380 B2	1/2007	Soininen	7,357,138 B2	4/2008	Ji et al.
7,163,393 B2	1/2007	Adachi et al.	7,361,447 B2	4/2008	Jung
7,163,721 B2	1/2007	Zhang et al.	7,375,035 B2	5/2008	Heden et al.
7,163,900 B2	1/2007	Weber	7,376,520 B2	5/2008	Wong
7,168,852 B2	1/2007	Linnarsson	7,378,618 B1	5/2008	Sorabji et al.
7,172,497 B2	2/2007	Basol et al.	7,379,785 B2	5/2008	Higashi et al.
7,173,216 B2	2/2007	Ptak	D571,383 S	6/2008	Ota et al.
7,183,229 B2	2/2007	Yamanaka	D571,831 S	6/2008	Ota et al.
7,186,648 B1	3/2007	Rozbicki	7,381,644 B1	6/2008	Soubramonium et al.
7,192,824 B2	3/2007	Ahn et al.	7,387,685 B2	6/2008	Choi et al.
7,192,892 B2	3/2007	Ahn et al.	7,393,207 B2	7/2008	Imai
7,195,479 B2	3/2007	Beatty et al.	7,393,418 B2	7/2008	Yokogawa
7,195,693 B2	3/2007	Cowans	7,393,736 B2	7/2008	Ahn et al.
D541,125 S	4/2007	Gaudron	7,393,765 B2	7/2008	Hanawa et al.
7,198,447 B2	4/2007	Morimitsu et al.	7,396,491 B2	7/2008	Marking et al.
7,199,513 B2	4/2007	Huber et al.	7,399,388 B2	7/2008	Moghadam et al.
7,201,943 B2	4/2007	Park et al.	7,399,570 B2	7/2008	Lee et al.
7,202,148 B2	4/2007	Chen et al.	7,402,534 B2	7/2008	Mahajani
7,202,512 B2	4/2007	Chen et al.	7,405,166 B2	7/2008	Liang et al.
7,204,886 B2	4/2007	Chen et al.	7,405,454 B2	7/2008	Ahn et al.
7,204,887 B2	4/2007	Kawamura et al.	D575,713 S	8/2008	Ratcliffe
7,205,246 B2	4/2007	MacNeil et al.	7,408,225 B2	8/2008	Shinriki et al.
7,205,247 B2	4/2007	Lee et al.	7,410,290 B2	8/2008	Tanaka
			7,410,666 B2	8/2008	Elers
			7,411,352 B2	8/2008	Madocks
			7,414,281 B1	8/2008	Fastow
			D576,001 S	9/2008	Brunderman

(56)

References Cited

U.S. PATENT DOCUMENTS

7,422,635 B2	9/2008	Zheng et al.	7,638,951 B2	12/2009	DeVincentis et al.
7,422,636 B2	9/2008	Ishizaka	7,640,142 B2	12/2009	Tachikawa et al.
7,422,653 B2	9/2008	Blahnik et al.	7,645,341 B2	1/2010	Kennedy et al.
7,422,775 B2	9/2008	Ramaswamy et al.	7,645,484 B2	1/2010	Ishizaka
7,425,224 B2	9/2008	Nguyen	7,648,895 B2	1/2010	Kurokawa et al.
7,427,571 B2	9/2008	Lindeboom et al.	7,648,927 B2	1/2010	Singh et al.
7,429,532 B2	9/2008	Ramaswamy et al.	7,651,269 B2	1/2010	Comendant
7,431,966 B2	10/2008	Derderian et al.	7,651,583 B2	1/2010	Kent et al.
7,432,476 B2	10/2008	Morita et al.	7,651,955 B2	1/2010	Ranish et al.
7,437,060 B2	10/2008	Wang et al.	7,651,959 B2	1/2010	Fukazawa et al.
7,442,275 B2	10/2008	Cowans	7,651,961 B2	1/2010	Clark
7,456,429 B2	11/2008	Levy	D609,652 S	2/2010	Nagasaka
D583,395 S	12/2008	Ueda	D609,655 S	2/2010	Sugimoto
7,467,632 B2	12/2008	Lee et al.	7,661,299 B2	2/2010	Kusunoki
7,473,655 B2	1/2009	Wang et al.	7,662,689 B2	2/2010	Boyanov et al.
7,475,588 B2	1/2009	Dimeo et al.	7,670,432 B2	3/2010	Li
7,476,291 B2	1/2009	Wang et al.	7,674,726 B2	3/2010	Hasper et al.
7,479,198 B2	1/2009	Guffrey	7,678,197 B2	3/2010	Maki
7,482,247 B1	1/2009	Papasouliotis	7,678,715 B2	3/2010	Mungekar et al.
7,482,283 B2	1/2009	Yamasaki et al.	7,682,454 B2	3/2010	Sneh
D585,968 S	2/2009	Elkins et al.	7,682,657 B2	3/2010	Sherman
7,489,389 B2	2/2009	Shibazaki et al.	D613,829 S	4/2010	Griffin et al.
7,494,882 B2	2/2009	Vitale	D614,153 S	4/2010	Fondurulia et al.
7,497,614 B2	3/2009	Gaff	D614,258 S	4/2010	Kojima
7,498,242 B2	3/2009	Kumar et al.	D614,267 S	4/2010	Breda
7,501,292 B2	3/2009	Matsushita et al.	D614,268 S	4/2010	Breda
7,501,355 B2	3/2009	Bhatia et al.	D614,593 S	4/2010	Lee
7,503,980 B2	3/2009	Kida et al.	7,690,881 B2	4/2010	Yamagishi
7,504,344 B2	3/2009	Matsuki et al.	7,691,205 B2	4/2010	Ikedo
D590,933 S	4/2009	Vansell	7,692,171 B2	4/2010	Kaszuba et al.
7,514,058 B1	4/2009	Hitzman et al.	7,695,808 B2	4/2010	Tuma
7,514,375 B1	4/2009	Shanker et al.	D616,390 S *	5/2010	Sato D13/182
D593,585 S	6/2009	Ota et al.	D616,394 S	5/2010	Sato
D593,969 S	6/2009	Li	7,712,435 B2	5/2010	Yoshizaki et al.
7,541,297 B2	6/2009	Mallick et al.	7,713,874 B2	5/2010	Milligan
7,544,398 B1	6/2009	Chang et al.	7,716,993 B2	5/2010	Ozawa et al.
7,547,363 B2	6/2009	Tomiyasu et al.	7,718,930 B2	5/2010	Kawasaki et al.
7,547,633 B2 *	6/2009	Ranish H01L 21/67115 438/687	7,720,560 B2	5/2010	Menser et al.
7,550,396 B2	6/2009	Frohberg et al.	7,723,648 B2	5/2010	Tsukamoto et al.
D596,476 S	7/2009	Welch	7,725,012 B2	5/2010	Aggarwal et al.
7,561,982 B2	7/2009	Rund et al.	7,727,864 B2	6/2010	Elers
7,563,715 B2	7/2009	Haukka et al.	7,727,880 B1	6/2010	Chattopadhyay et al.
7,566,079 B1 *	7/2009	Callahan F24F 13/0209 285/314	7,732,343 B2	6/2010	Niroomand et al.
7,566,891 B2	7/2009	Rocha-Alvarez et al.	7,736,437 B2	6/2010	Cadwell et al.
7,569,193 B2	8/2009	Ferron et al.	7,736,528 B2	6/2010	Okita et al.
7,575,968 B2	8/2009	Sadaka et al.	7,736,600 B2	6/2010	Clark et al.
7,579,285 B2	8/2009	Zimmerman et al.	7,737,035 B1	6/2010	Lind et al.
7,579,785 B2	8/2009	Shinmen et al.	7,740,437 B2	6/2010	de Ridder et al.
D600,223 S	9/2009	Aggarwal	7,740,705 B2	6/2010	Li
7,582,555 B1	9/2009	Lang	7,745,346 B2	6/2010	Hausmann et al.
7,582,575 B2	9/2009	Fukazawa et al.	7,748,760 B2	7/2010	Kushida
7,589,003 B2	9/2009	Kouvetakis et al.	7,749,563 B2	7/2010	Zheng et al.
7,589,028 B1	9/2009	Cho et al.	7,753,584 B2	7/2010	Gambino et al.
7,589,029 B2	9/2009	Derderian et al.	7,754,621 B2	7/2010	Putjkonen
7,591,601 B2	9/2009	Matsuoka et al.	7,758,698 B2	7/2010	Bang et al.
7,591,907 B2	9/2009	Chen et al.	7,763,869 B2	7/2010	Matsushita et al.
D602,575 S	10/2009	Breda	7,767,262 B2	8/2010	Clark
7,598,513 B2	10/2009	Kouvetakis et al.	7,771,796 B2	8/2010	Kohno et al.
7,601,223 B2	10/2009	Lindfors et al.	7,780,440 B2	8/2010	Shibagaki et al.
7,601,225 B2	10/2009	Tuominen et al.	7,780,789 B2	8/2010	Wu et al.
7,601,652 B2	10/2009	Singh et al.	7,781,352 B2	8/2010	Fukazawa et al.
7,611,640 B1	11/2009	Howald et al.	7,789,559 B2	9/2010	Waser et al.
7,611,751 B2	11/2009	Elers	7,789,965 B2	9/2010	Matsushita et al.
7,611,980 B2	11/2009	Wells et al.	7,790,633 B1	9/2010	Tarafdar et al.
7,618,226 B2	11/2009	Takizawa	7,794,546 B2	9/2010	Li
7,621,672 B2	11/2009	Ripley	7,798,096 B2	9/2010	Mahajani et al.
7,622,369 B1	11/2009	Lee et al.	7,799,300 B2	9/2010	Lindfors et al.
7,622,378 B2	11/2009	Liu et al.	7,799,706 B2	9/2010	Yeom et al.
7,623,940 B2	11/2009	Huskamp et al.	7,803,722 B2	9/2010	Liang
D606,952 S	12/2009	Lee	D625,977 S	10/2010	Watson et al.
7,625,820 B1	12/2009	Papasouliotis	7,795,160 B2	10/2010	Wang et al.
7,629,277 B2	12/2009	Ghatnagar	7,806,587 B2	10/2010	Kobayashi
7,632,549 B2	12/2009	Goundar	7,807,566 B2	10/2010	Tsuji et al.
			7,807,578 B2	10/2010	Bencher et al.
			7,816,278 B2	10/2010	Reed et al.
			7,824,492 B2	11/2010	Tois et al.
			7,825,040 B1	11/2010	Fukazawa et al.
			7,829,460 B2	11/2010	Streck et al.
			7,833,348 B2	11/2010	Wada et al.

(56)

References Cited

U.S. PATENT DOCUMENTS

7,833,353 B2	11/2010	Furukawahara et al.	D651,291 S	12/2011	Liebson et al.
7,838,084 B2	11/2010	Derderian et al.	8,071,451 B2	12/2011	Berry
7,842,518 B2	11/2010	Miyajima	8,071,452 B2	12/2011	Raisanen
7,842,622 B1	11/2010	Lee et al.	8,072,578 B2	12/2011	Yasuda et al.
D629,874 S	12/2010	Hermans	8,076,230 B2	12/2011	Wei
7,850,449 B2	12/2010	Yang et al.	8,076,237 B2	12/2011	Uzoh
7,851,019 B2	12/2010	Tuominen et al.	8,076,250 B1	12/2011	Rajagopalan
7,851,232 B2	12/2010	van Schravendijk et al.	8,076,251 B2	12/2011	Akae et al.
7,858,519 B2	12/2010	Liu et al.	8,078,310 B2	12/2011	Nishimoto et al.
7,858,533 B2	12/2010	Liu et al.	8,082,946 B2	12/2011	Laverdiere et al.
7,865,070 B2	1/2011	Nakamura	8,084,104 B2	12/2011	Shinriki et al.
7,871,198 B2	1/2011	Rempe et al.	8,084,372 B2	12/2011	You et al.
7,874,726 B2	1/2011	Jacobs et al.	D652,896 S	1/2012	Gether
7,884,918 B2	2/2011	Hattori	8,092,604 B2	1/2012	Tomiyasu et al.
7,888,233 B1	2/2011	Gauri	8,092,606 B2	1/2012	Park et al.
7,894,474 B1	2/2011	Bell	8,100,583 B2	1/2012	Aggarwal
D634,329 S	3/2011	Wastrom	D653,734 S	2/2012	Sisk
D634,719 S	3/2011	Yasuda et al.	D654,882 S	2/2012	Honma et al.
7,897,215 B1	3/2011	Fair et al.	D654,884 S	2/2012	Honma
7,897,217 B2	3/2011	Faguet	D655,055 S	2/2012	Toll
7,902,009 B2	3/2011	Simonelli et al.	8,110,099 B2	2/2012	Hersey et al.
7,902,582 B2	3/2011	Forbes et al.	8,114,734 B2	2/2012	Yang et al.
7,906,174 B1	3/2011	Wu et al.	8,119,466 B2	2/2012	Avouris
7,910,288 B2	3/2011	Abatchev et al.	8,119,527 B1	2/2012	Chadrashekar et al.
7,910,452 B2	3/2011	Roh et al.	D655,260 S	3/2012	Honma et al.
7,910,494 B2	3/2011	Dip et al.	D655,261 S	3/2012	Honma et al.
7,915,139 B1	3/2011	Lang	D655,599 S	3/2012	Durham
7,915,667 B2	3/2011	Knoeffler et al.	8,129,290 B2	3/2012	Balseanu et al.
7,919,142 B2	4/2011	Yeom et al.	8,137,462 B2	3/2012	Fondurulia et al.
7,919,416 B2	4/2011	Lee et al.	8,137,465 B1	3/2012	Shrinivasan et al.
7,923,382 B2	4/2011	Huotari et al.	8,138,104 B2	3/2012	Balseanu et al.
7,925,378 B2	4/2011	Gilchrist et al.	8,138,676 B2	3/2012	Mills
7,935,940 B1	5/2011	Smargiassi	8,142,862 B2	3/2012	Lee et al.
7,939,447 B2	5/2011	Bauer et al.	8,143,174 B2	3/2012	Xia et al.
7,942,969 B2	5/2011	Riker et al.	8,147,242 B2	4/2012	Shibagaki et al.
7,946,762 B2	5/2011	Yednak	8,152,922 B2	4/2012	Schmidt et al.
7,951,262 B2	5/2011	Koshiishi et al.	8,158,512 B2	4/2012	Ji et al.
7,955,516 B2	6/2011	Chandrachood et al.	8,172,947 B2	5/2012	Shibata et al.
7,955,646 B2	6/2011	Cruse et al.	8,173,554 B2	5/2012	Lee et al.
7,955,650 B2	6/2011	Tsuji	8,174,400 B2	5/2012	Park et al.
7,957,708 B2	6/2011	Karschnia et al.	8,178,436 B2	5/2012	King et al.
7,963,736 B2	6/2011	Takizawa et al.	8,187,679 B2	5/2012	Dickey et al.
7,967,913 B2	6/2011	Hua et al.	8,187,951 B1	5/2012	Wang
7,972,980 B2	7/2011	Lee et al.	8,192,901 B2	6/2012	Kageyama
7,977,256 B2	7/2011	Liu et al.	8,196,234 B2	6/2012	Glunk
7,981,751 B2	7/2011	Zhu et al.	8,197,915 B2	6/2012	Oka et al.
D643,055 S	8/2011	Takahashi	8,198,168 B2	6/2012	Tanioku
7,989,365 B2	8/2011	Park et al.	8,202,575 B2	6/2012	Monsma et al.
7,989,736 B2	8/2011	Park et al.	8,206,506 B2	6/2012	Kadkhodayan et al.
7,992,318 B2	8/2011	Kawaji	8,216,380 B2	7/2012	White et al.
7,993,457 B1	8/2011	Krotov et al.	8,227,032 B2	7/2012	Dussarrat et al.
7,994,070 B1	8/2011	Dip et al.	8,231,799 B2	7/2012	Bera et al.
7,994,721 B2	8/2011	Espiau et al.	D665,055 S	8/2012	Yanagisawa et al.
7,997,795 B2	8/2011	Schwagerman et al.	8,241,991 B2	8/2012	Hsieh et al.
7,998,875 B2	8/2011	DeYoung	8,241,992 B2	8/2012	Clevenger et al.
8,003,174 B2	8/2011	Fukazawa	8,242,028 B1	8/2012	van Schravendijk
8,003,919 B2	8/2011	Goto et al.	8,242,031 B2	8/2012	Mallick et al.
8,004,198 B2	8/2011	Bakre et al.	8,246,900 B2	8/2012	Kasai et al.
8,020,315 B2	9/2011	Nishimura	8,252,114 B2	8/2012	Vukovic
8,030,129 B2	10/2011	Jeong	8,252,659 B2	8/2012	Huyghabaert et al.
8,033,771 B1	10/2011	Gage et al.	8,252,691 B2	8/2012	Beynet et al.
8,038,835 B2	10/2011	Hayashi et al.	8,253,204 B2	8/2012	Lee et al.
8,041,197 B2	10/2011	Kasai et al.	8,267,633 B2	9/2012	Obikane
8,041,450 B2	10/2011	Takizawa et al.	8,272,516 B2	9/2012	Salvador
8,043,972 B1	10/2011	Liu et al.	8,278,176 B2	10/2012	Bauer et al.
8,046,193 B2	10/2011	Yetter et al.	8,282,769 B2	10/2012	Iizuka
8,047,711 B2	11/2011	Ploechinger	8,282,847 B2	10/2012	Romano
8,048,783 B2	11/2011	Chung et al.	8,282,992 B2 *	10/2012	Myo C23C 16/4558 427/248.1
8,051,799 B2	11/2011	Itagaki et al.	8,287,648 B2	10/2012	Reed et al.
8,052,794 B2	11/2011	Sumakeris et al.	8,291,857 B2 *	10/2012	Lam C23C 16/4558 118/723 ME
8,055,378 B2	11/2011	Numakura	8,293,016 B2	10/2012	Bahng et al.
8,060,252 B2	11/2011	Gage et al.	8,293,642 B2	10/2012	Kim
8,083,853 B2	11/2011	Choi et al.	8,298,336 B2	10/2012	Wang et al.
RE43,023 E	12/2011	Nakashima et al.	8,298,951 B1	10/2012	Nakano
D649,986 S	12/2011	Fujikata et al.	8,307,472 B1	11/2012	Saxon et al.
			8,309,173 B2	11/2012	Tuominen et al.
			8,318,327 B2	11/2012	O'Donnell

(56)

References Cited

U.S. PATENT DOCUMENTS

8,323,413 B2	12/2012	Son	8,647,993 B2	2/2014	Lavoie et al.
8,324,699 B2	12/2012	Ichijo et al.	8,651,788 B1	2/2014	Budde
8,328,939 B2	12/2012	Choi et al.	8,664,627 B1	3/2014	Ishikawa et al.
8,329,599 B2	12/2012	Fukazawa et al.	8,667,654 B2	3/2014	Gros-Jean
8,333,839 B2	12/2012	Oh	8,668,957 B2	3/2014	Dussarrat et al.
8,334,219 B2	12/2012	Lee et al.	8,669,185 B2	3/2014	Onizawa
8,338,809 B2	12/2012	Yang et al.	8,679,958 B2	3/2014	Takamure et al.
8,349,083 B2	1/2013	Takasuka et al.	D702,188 S	4/2014	Jacobs
D676,943 S	2/2013	Kluss	8,683,943 B2	4/2014	Onodera et al.
8,367,528 B2	2/2013	Bauer et al.	8,697,198 B2	4/2014	Lee
8,372,204 B2	2/2013	Nakamura	8,703,002 B2	4/2014	Matsudo et al.
8,378,464 B2	2/2013	Kato et al.	8,709,162 B2	4/2014	Leung et al.
8,382,370 B2	2/2013	Aggarwal et al.	8,710,580 B2	4/2014	Sakuma et al.
8,382,939 B2*	2/2013	Kutney H01J 37/32834 156/345.34	8,711,338 B2	4/2014	Liu et al.
			D705,745 S	5/2014	Kurs et al.
			D705,762 S	5/2014	Yu
			8,664,127 B2	5/2014	Bhatia et al.
			8,720,965 B2	5/2014	Hino et al.
			8,721,791 B2	5/2014	Choi et al.
			8,722,510 B2	5/2014	Watanabe et al.
8,393,091 B2	3/2013	Kawamoto	8,722,546 B2	5/2014	Fukazawa et al.
8,394,466 B2	3/2013	Hong et al.	8,726,837 B2	5/2014	Patalay et al.
8,398,773 B2	3/2013	Jdira et al.	8,728,832 B2	5/2014	Raisanen et al.
8,402,918 B2	3/2013	Kadkhodayan et al.	8,728,956 B2	5/2014	Lavoie et al.
8,404,499 B2	3/2013	Moffatt	8,741,062 B2	6/2014	Lindfors et al.
8,415,258 B2	4/2013	Akae	8,741,065 B2	6/2014	Odagiri et al.
8,415,259 B2	4/2013	Lee et al.	8,742,668 B2	6/2014	Nakano et al.
8,415,587 B2	4/2013	Millman et al.	8,758,512 B2	6/2014	Lee
8,419,959 B2	4/2013	Bettencourt et al.	8,759,223 B2	6/2014	Sapre et al.
8,425,682 B2	4/2013	Wang et al.	D709,536 S	7/2014	Yoshimura et al.
8,430,620 B1	4/2013	Blank et al.	D709,537 S	7/2014	Kuwabara et al.
8,440,259 B2	5/2013	Chiang et al.	8,764,085 B2	7/2014	Urabe
8,443,484 B2	5/2013	Ozaki et al.	8,771,791 B2	7/2014	Lee et al.
8,444,120 B2	5/2013	Gregg et al.	8,771,807 B2	7/2014	Xiao et al.
8,445,075 B2	5/2013	Xu et al.	8,779,502 B2	7/2014	Sakuma et al.
8,450,191 B2	5/2013	Wang	8,784,950 B2	7/2014	Fukazawa et al.
8,454,749 B2	6/2013	Li	8,784,951 B2	7/2014	Fukazawa et al.
8,465,811 B2	6/2013	Ueda	8,785,215 B2	7/2014	Kobayashi et al.
8,465,903 B2	6/2013	Weidman et al.	8,785,311 B2	7/2014	Miyoshi
8,466,411 B2	6/2013	Arai	8,790,743 B1	7/2014	Omari
8,470,187 B2	6/2013	Ha	8,790,749 B2	7/2014	Omori et al.
8,470,718 B2	6/2013	Lee	8,802,201 B2	8/2014	Raisanen et al.
8,484,846 B2	7/2013	Dhindsa	8,809,170 B2	8/2014	Bauer
8,492,170 B2	7/2013	Xie et al.	D712,358 S	9/2014	Allen et al.
8,496,377 B2	7/2013	Harr et al.	D712,359 S	9/2014	Allen et al.
8,496,756 B2	7/2013	Cruse et al.	8,820,809 B2	9/2014	Ando et al.
8,497,213 B2	7/2013	Yasui et al.	8,821,640 B2	9/2014	Cleary et al.
8,501,599 B2	8/2013	Ueno et al.	8,821,985 B2	9/2014	Shao et al.
8,506,162 B2	8/2013	Schick et al.	8,823,672 B2	9/2014	Kim
8,506,713 B2	8/2013	Takagi	8,828,886 B2	9/2014	Samukawa et al.
8,507,720 B2	8/2013	Shay	8,841,182 B1	9/2014	Chen et al.
8,524,612 B2	9/2013	Li et al.	8,845,806 B2	9/2014	Aida et al.
8,529,701 B2	9/2013	Morita	8,846,502 B2	9/2014	Haukka et al.
8,535,767 B1	9/2013	Kimura	D715,410 S	10/2014	Lohmann
8,536,068 B2	9/2013	Weidman et al.	8,859,368 B2	10/2014	Deniz
D691,974 S	10/2013	Osada et al.	8,860,955 B2	10/2014	Rodnick et al.
8,551,892 B2	10/2013	Nakano	8,864,202 B1	10/2014	Schrameyer
8,557,712 B1	10/2013	Antonelli et al.	8,864,375 B2	10/2014	Abe et al.
8,562,272 B2	10/2013	Lenz	D716,742 S	11/2014	Jang et al.
8,563,443 B2	10/2013	Fukazawa	8,876,974 B2	11/2014	Wan
8,569,184 B2	10/2013	Oka	8,877,300 B2	11/2014	Lee
D693,200 S	11/2013	Saunders	8,877,655 B2	11/2014	Shero et al.
8,573,152 B2	11/2013	de la Llera et al.	8,882,923 B2	11/2014	Saido et al.
8,573,154 B2	11/2013	Yorozuya	8,883,270 B2	11/2014	Shero et al.
8,586,484 B2	11/2013	Matsuyama et al.	8,895,108 B2	11/2014	Lee
8,591,659 B1	11/2013	Fang et al.	8,895,395 B1	11/2014	Kerber et al.
8,592,005 B2	11/2013	Ueda	8,900,935 B2	12/2014	Guo et al.
D694,790 S	12/2013	Matsumoto et al.	8,900,999 B1	12/2014	Wu et al.
D695,240 S	12/2013	Iida et al.	8,901,016 B2	12/2014	Jeongseok et al.
8,608,885 B2	12/2013	Goto et al.	8,911,553 B2	12/2014	Baluja et al.
8,614,047 B2	12/2013	Ayothi et al.	8,911,826 B2	12/2014	Adachi et al.
8,616,765 B2	12/2013	Darabnia et al.	8,912,101 B2	12/2014	Tsuji et al.
8,617,411 B2	12/2013	Singh	D720,838 S	1/2015	Yamagishi et al.
D697,038 S	1/2014	Matsumoto et al.	8,927,906 B2	1/2015	Tadokoro et al.
8,623,770 B1	1/2014	Gao et al.	8,932,802 B2	1/2015	Wu et al.
8,633,115 B2	1/2014	Chang et al.	8,933,375 B2	1/2015	Dunn et al.
D698,904 S	2/2014	Milligan et al.	8,940,646 B1	1/2015	Chandrasekharan
8,642,488 B2	2/2014	Liu et al.	D723,153 S	2/2015	Borkholder
8,647,439 B2	2/2014	Sanchez et al.	8,945,305 B2	2/2015	Marsh
8,647,722 B2	2/2014	Kobayashi et al.			

(56)

References Cited

U.S. PATENT DOCUMENTS

8,945,306 B2	2/2015	Tsuda		D743,513 S	11/2015	Yamagishi
8,945,339 B2	2/2015	Kakimoto		9,174,178 B2	11/2015	Berger et al.
8,946,830 B2	2/2015	Jung et al.		9,175,394 B2	11/2015	Yudovsky et al.
8,956,971 B2	2/2015	Huakka		9,177,784 B2	11/2015	Raisanen et al.
8,956,983 B2	2/2015	Swaminathan		9,184,047 B2	11/2015	Liu et al.
D723,330 S	3/2015	York		9,184,054 B1	11/2015	Huang et al.
D724,553 S	3/2015	Choi		9,190,263 B2	11/2015	Ishikawa et al.
D724,701 S	3/2015	Yamagishi et al.		9,190,264 B2	11/2015	Yuasa et al.
D725,168 S	3/2015	Yamagishi		9,196,483 B1	11/2015	Lee et al.
8,967,608 B2	3/2015	Mitsumori et al.		D745,641 S	12/2015	Blum
8,969,934 B1	3/2015	Cheng et al.		9,202,727 B2	12/2015	Dunn et al.
8,974,868 B2	3/2015	Ishikawa et al.		9,214,333 B1	12/2015	Sims et al.
8,980,006 B2	3/2015	Huh et al.		9,214,340 B2	12/2015	Kurita et al.
8,986,456 B2	3/2015	Fondurulia et al.		9,219,006 B2	12/2015	Chatterjee
8,991,214 B2	3/2015	Hoshino et al.		9,223,203 B2	12/2015	Farm et al.
8,991,887 B2	3/2015	Shin et al.		9,228,259 B2	1/2016	Haukka et al.
8,993,054 B2	3/2015	Jung et al.		9,240,412 B2	1/2016	Xie et al.
8,993,457 B1	3/2015	Ramkumar et al.		9,245,742 B2	1/2016	Haukka
D726,365 S	4/2015	Weigensberg		9,252,024 B2	2/2016	Lam et al.
D726,884 S	4/2015	Yamagishi et al.		9,252,238 B1	2/2016	Trevino et al.
8,999,102 B2	4/2015	Miyoshi et al.		9,257,274 B2	2/2016	Kang et al.
9,004,744 B1	4/2015	Kemp		9,263,298 B2	2/2016	Matsumoto et al.
9,005,539 B2	4/2015	Halpin et al.		9,267,204 B2	2/2016	Honma
9,017,481 B1 *	4/2015	Petti	H01J 37/32449 118/724	9,267,850 B2	2/2016	Aggarwal
				D751,176 S	3/2016	Schoenherr et al.
9,017,933 B2	4/2015	Liu et al.		9,275,834 B1	3/2016	Park et al.
9,018,093 B2	4/2015	Tsuji et al.		9,281,277 B2	3/2016	Baek et al.
9,018,111 B2	4/2015	Milligan et al.		9,284,642 B2	3/2016	Nakano
9,018,567 B2	4/2015	de Ridder et al.		9,287,273 B2	3/2016	Ragnarsson et al.
9,021,985 B2	5/2015	Alokozai et al.		9,297,705 B2	3/2016	Aggarwal
9,023,737 B2	5/2015	Beynet et al.		9,299,557 B2	3/2016	Tolle et al.
9,023,738 B2	5/2015	Kato et al.		9,299,595 B2	3/2016	Dunn et al.
9,029,244 B2	5/2015	Won et al.		D753,269 S	4/2016	Yamagishi et al.
9,029,253 B2	5/2015	Milligan et al.		D753,629 S	4/2016	Plattard
9,029,272 B1	5/2015	Nakano		9,305,836 B1	4/2016	Gates et al.
D732,145 S	6/2015	Yamagishi		9,309,598 B2	4/2016	Wang et al.
D732,644 S	6/2015	Yamagishi et al.		9,309,978 B2	4/2016	Hatch et al.
D733,257 S	6/2015	Schoenherr et al.		9,310,684 B2	4/2016	Meyers et al.
D733,261 S	6/2015	Yamagishi et al.		9,312,155 B2	4/2016	Mori
D733,262 S	6/2015	Kang		9,315,897 B2	4/2016	Byun
9,057,388 B2	6/2015	Comeau et al.		9,324,811 B2	4/2016	Weeks
9,064,815 B2	6/2015	Zhang et al.		9,324,846 B1	4/2016	Camillo
D733,843 S	7/2015	Yamagishi		D756,929 S	5/2016	Harek et al.
D734,377 S	7/2015	Hirakida		9,331,200 B1	5/2016	Wang et al.
9,076,635 B2	7/2015	Gross et al.		9,337,031 B2	5/2016	Kim et al.
9,076,726 B2	7/2015	Kauerauf et al.		9,337,054 B2	5/2016	Hunks et al.
D735,836 S	8/2015	Yamagishi et al.		9,337,057 B2	5/2016	Park et al.
D736,348 S	8/2015	Tan		9,341,296 B2	5/2016	Yednak
9,095,869 B2	8/2015	Kilpi et al.		9,343,297 B1	5/2016	Fukazawa et al.
9,096,931 B2	8/2015	Yednak et al.		9,343,308 B2	5/2016	Isii
9,099,423 B2	8/2015	Weeks et al.		9,343,343 B2	5/2016	Mori
9,099,505 B2	8/2015	Kusakabe et al.		9,343,350 B2	5/2016	Arai
9,111,972 B2	8/2015	Takeshita et al.		9,349,620 B2	5/2016	Kamata et al.
9,117,657 B2	8/2015	Nakano et al.		9,353,440 B2	5/2016	Ge et al.
9,117,866 B2	8/2015	Marquardt et al.		9,353,441 B2	5/2016	Chung
D739,222 S	9/2015	Chadbourne		9,355,876 B2	5/2016	Reuter et al.
9,123,510 B2	9/2015	Nakano et al.		9,355,882 B2	5/2016	Wu et al.
9,123,577 B2	9/2015	Fujimoto et al.		D759,137 S	6/2016	Hassan
9,127,358 B2	9/2015	Inoue et al.		D759,193 S	6/2016	Gutierrez et al.
9,127,362 B2 *	9/2015	Scheible	C23C 14/3407	9,362,107 B2	6/2016	Thadani et al.
9,129,897 B2	9/2015	Pore et al.		9,362,137 B2	6/2016	Kang et al.
9,136,108 B2	9/2015	Matsushita et al.		9,362,180 B2	6/2016	Lee et al.
9,136,180 B2	9/2015	Machkaoutsan		9,365,924 B2	6/2016	Nonaka
9,142,393 B2	9/2015	Okabe et al.		9,368,352 B2	6/2016	Takamure et al.
9,142,437 B2	9/2015	Fosnight et al.		9,370,863 B2	6/2016	Tsuji et al.
9,142,764 B1	9/2015	Wang		9,378,969 B2	6/2016	Hsu et al.
9,153,441 B2	10/2015	Takamure et al.		9,384,987 B2	7/2016	Jung et al.
9,163,310 B2	10/2015	Lee		9,390,909 B2	7/2016	Pasquale et al.
9,166,012 B2	10/2015	Sim et al.		9,394,608 B2	7/2016	Shero et al.
9,169,975 B2	10/2015	Sarin et al.		9,396,934 B2	7/2016	Tolle
9,171,714 B2	10/2015	Mori		9,396,956 B1	7/2016	Fukazawa
9,171,715 B2	10/2015	Matero		9,399,228 B2	7/2016	Breiling et al.
9,171,716 B2	10/2015	Fukuda		D764,196 S	8/2016	Handler et al.
D742,202 S	11/2015	Cyphers et al.		9,404,587 B2	8/2016	Shugrue
D743,357 S	11/2015	Vyne		9,412,564 B2	8/2016	Milligan
				9,412,581 B2	8/2016	Thadani et al.
				9,412,582 B2	8/2016	Sasaki et al.
				9,418,885 B2	8/2016	Sung et al.
				9,425,078 B2	8/2016	Tang et al.

(56)

References Cited

U.S. PATENT DOCUMENTS

9,428,833	B1	8/2016	Duvall et al.	9,754,779	B1	9/2017	Ishikawa
9,443,725	B2	9/2016	Liu et al.	9,754,818	B2	9/2017	Shiu et al.
9,447,498	B2	9/2016	Shiba et al.	9,759,489	B2	9/2017	Kaneko
9,449,793	B2	9/2016	Shaji et al.	9,765,432	B2	9/2017	Ge et al.
9,449,795	B2	9/2016	Sabri et al.	9,773,818	B2	9/2017	Kimura
9,449,987	B1	9/2016	Miyata et al.	D800,782	S	10/2017	Bever et al.
9,455,138	B1	9/2016	Fukazawa	9,778,561	B2	10/2017	Marks et al.
9,455,177	B1	9/2016	Park et al.	9,780,225	B2	10/2017	Venkatasubramanian et al.
9,464,352	B2	10/2016	Nakano et al.	9,786,491	B2	10/2017	Suzuki et al.
9,472,432	B1	10/2016	Blank	9,786,570	B2	10/2017	Kang et al.
9,474,163	B2	10/2016	Tolle et al.	9,790,595	B2	10/2017	Jung et al.
9,478,414	B2	10/2016	Kobayashi et al.	9,793,115	B2	10/2017	Tolle
9,478,415	B2	10/2016	Kimura	9,793,135	B1	10/2017	Zaitsu et al.
D770,993	S	11/2016	Yoshida et al.	9,793,148	B2	10/2017	Yamagishi et al.
9,484,191	B2	11/2016	Winkler	9,798,308	B2	10/2017	Mimura
9,496,225	B1	11/2016	Adusumilli et al.	9,799,736	B1	10/2017	Ebrish et al.
9,514,927	B2	12/2016	Tolle et al.	D801,942	S	11/2017	Riker et al.
9,514,932	B2	12/2016	Mallick et al.	D802,546	S	11/2017	Jang et al.
9,520,289	B2	12/2016	Park et al.	9,808,246	B2	11/2017	Shelton et al.
9,523,148	B1	12/2016	Pore et al.	9,812,319	B1	11/2017	Fukazawa et al.
D777,546	S	1/2017	Ishii et al.	9,812,320	B1	11/2017	Pore et al.
9,543,180	B2	1/2017	Kamiya	9,812,372	B2	11/2017	Choi et al.
9,556,516	B2	1/2017	Takamure	9,820,289	B1	11/2017	Pawar et al.
9,558,931	B2	1/2017	Tang	9,824,884	B1	11/2017	Sims et al.
9,564,312	B2	2/2017	Henri et al.	9,824,893	B1	11/2017	Smith et al.
9,564,314	B2	2/2017	Takamure et al.	9,837,355	B2	12/2017	Briggs et al.
9,570,302	B1	2/2017	Chang et al.	9,847,221	B1	12/2017	McLaughlin et al.
9,574,268	B1	2/2017	Dunn et al.	9,850,573	B1	12/2017	Sun
9,576,952	B2	2/2017	Joshi et al.	D807,494	S	1/2018	Kim et al.
9,583,333	B2	2/2017	Chatterjee	D808,254	S	1/2018	Deleu
9,583,345	B2	2/2017	Chen et al.	9,859,151	B1	1/2018	Niskanen
D782,419	S	3/2017	Willette	9,865,455	B1	1/2018	Sims et al.
9,589,770	B2	3/2017	Winkler	9,865,456	B1	1/2018	Pandey et al.
9,605,342	B2	3/2017	Alokozai et al.	9,865,815	B2	1/2018	Hausmann
9,605,343	B2	3/2017	Winkler	9,868,131	B2	1/2018	Kilpi et al.
9,607,837	B1	3/2017	Namba	9,870,964	B1	1/2018	Yoshino et al.
D783,351	S	4/2017	Fujino et al.	9,875,891	B2	1/2018	Henri et al.
D784,276	S	4/2017	Tiner et al.	9,875,893	B2	1/2018	Takamure et al.
9,613,801	B2	4/2017	Carcasi et al.	9,881,788	B2	1/2018	Kim et al.
9,627,221	B1	4/2017	Zaitsu et al.	D810,705	S	2/2018	Krishnan et al.
D785,766	S	5/2017	Sato	9,887,082	B1	2/2018	Pore et al.
D787,458	S	5/2017	Kim et al.	9,890,456	B2	2/2018	Tolle et al.
9,640,416	B2	5/2017	Arai	9,891,521	B2	2/2018	Kang et al.
9,640,448	B2	5/2017	Ikegawa et al.	9,892,908	B2	2/2018	Pettinger et al.
9,640,542	B2	5/2017	Lee et al.	9,892,913	B2	2/2018	Margetis et al.
9,644,266	B2	5/2017	Nasu et al.	9,895,715	B2	2/2018	Haukka et al.
9,647,114	B2	5/2017	Margetis	9,899,291	B2	2/2018	Kato
9,653,267	B2	5/2017	Carducci et al.	9,899,405	B2	2/2018	Kim
9,657,845	B2	5/2017	Shugrue	9,905,420	B2	2/2018	Margetis et al.
9,659,799	B2	5/2017	Lawson	9,905,492	B2	2/2018	Tang et al.
9,663,857	B2	5/2017	Nakano et al.	9,909,214	B2	3/2018	Suemori
9,666,528	B1	5/2017	Bergendahl et al.	9,909,492	B2	3/2018	Jeswine
D789,888	S	6/2017	Jang et al.	9,911,676	B2	3/2018	Tang
D790,041	S	6/2017	Jang et al.	9,916,980	B1	3/2018	Knaepen
9,680,268	B1	6/2017	Finona	9,920,451	B2	3/2018	Sivaramakrishnan et al.
9,684,234	B2	6/2017	Darling et al.	9,922,824	B2	3/2018	Okada
9,685,320	B2	6/2017	Kang et al.	9,929,005	B1	3/2018	Shimamoto et al.
9,691,668	B2	6/2017	Chang et al.	9,929,011	B2	3/2018	Hawryluk et al.
9,691,771	B2	6/2017	Lansalot-Matras	9,929,055	B2	3/2018	Dube et al.
9,698,031	B2	7/2017	Kobayashi et al.	9,951,421	B2	4/2018	Lind
9,708,707	B2	7/2017	Ditizio et al.	9,960,033	B1	5/2018	Nozawa
9,708,708	B2	7/2017	Isobe et al.	9,960,072	B2	5/2018	Coomer
9,711,345	B2	7/2017	Shiba et al.	9,966,299	B2	5/2018	Tang et al.
D793,352	S	8/2017	Hill	9,984,869	B1	5/2018	Blanquart
D793,572	S	8/2017	Kozuka et al.	D819,580	S	6/2018	Krishnan et al.
D793,976	S	8/2017	Fukushima et al.	9,987,747	B2	6/2018	Hwang et al.
D795,208	S	8/2017	Sasaki et al.	9,991,138	B2	6/2018	Lin et al.
9,735,024	B2	8/2017	Zaitsu	9,996,004	B2	6/2018	Smith et al.
9,741,546	B2	8/2017	Carducci et al.	9,997,357	B2	6/2018	Arghavani et al.
9,741,559	B2	8/2017	Shimura et al.	9,997,373	B2	6/2018	Hudson
9,745,658	B2	8/2017	Kang et al.	10,032,628	B2	6/2018	Xie et al.
9,748,145	B1	8/2017	Kannan et al.	10,014,212	B2	7/2018	Chen et al.
D796,458	S	9/2017	Jang et al.	10,017,856	B1	7/2018	Arnepalli et al.
D796,670	S	9/2017	Dolk et al.	10,018,920	B2	7/2018	Chang et al.
D797,067	S	9/2017	Zhang et al.	10,023,960	B2	7/2018	Alokozai
				10,032,792	B2	7/2018	Kim et al.
				D825,614	S	8/2018	Bever et al.
				10,043,661	B2	8/2018	Kato et al.
				10,047,435	B2	8/2018	Haukka et al.

(56)

References Cited

U.S. PATENT DOCUMENTS

10,053,774 B2	8/2018	Tolle et al.	10,590,531 B1	3/2020	Shirako et al.
10,060,473 B2	8/2018	Davey et al.	10,600,637 B2	3/2020	Suzuki et al.
D827,592 S	9/2018	Ichino et al.	D880,437 S	4/2020	Lee et al.
10,083,836 B2	9/2018	Milligan	10,622,196 B2	4/2020	Nagayama et al.
D830,981 S	10/2018	Jeong et al.	10,648,788 B2	5/2020	Boyd et al.
10,087,522 B2	10/2018	Raisanen et al.	10,714,335 B2	7/2020	Kim et al.
10,087,525 B2	10/2018	Schmotzer et al.	10,763,139 B2	9/2020	Shindo
10,090,316 B2	10/2018	Ootsuka	D900,036 S	10/2020	Wuester et al.
10,103,040 B1	10/2018	Oosterlaken et al.	D903,477 S	12/2020	Goratela et al.
10,106,892 B1	10/2018	Siddiqui et al.	D913,980 S	3/2021	Lee et al.
RE47,145 E	11/2018	Hashimoto	D914,620 S	3/2021	Rokkam et al.
D833,581 S *	11/2018	Atwell D23/259	D917,825 S *	4/2021	Kirkland D34/29
10,121,671 B2	11/2018	Fu et al.	11,018,003 B2	5/2021	Huang et al.
10,134,617 B2	11/2018	Gurary et al.	D922,229 S	6/2021	Jun et al.
10,134,757 B2	11/2018	Chun et al.	2001/0000141 A1	4/2001	Zhou et al.
RE47,170 E	12/2018	Beynet et al.	2001/0001953 A1	5/2001	Griffiths et al.
10,147,600 B2	12/2018	Takamure et al.	2001/0002581 A1	6/2001	Nishikawa et al.
10,167,557 B2	1/2019	Hawkins et al.	2001/0003015 A1	6/2001	Chang et al.
10,177,024 B2	1/2019	Gomm et al.	2001/0003191 A1	6/2001	Kovacs et al.
10,177,025 B2	1/2019	Pore	2001/0003271 A1	6/2001	Otsuki
10,179,947 B2	1/2019	Fukazawa	2001/0004880 A1	6/2001	Cho et al.
10,186,420 B2	1/2019	Fukazawa	2001/0006070 A1	7/2001	Shang
10,190,213 B2	1/2019	Zhu et al.	2001/0007244 A1	7/2001	Matsuse
10,190,214 B2	1/2019	Shon et al.	2001/0007246 A1	7/2001	Ueda et al.
10,190,701 B2	1/2019	Raj et al.	2001/0007645 A1	7/2001	Honma
10,192,734 B2	1/2019	Sanchez et al.	2001/0014267 A1	8/2001	Yamaga et al.
10,193,429 B2	1/2019	Smith et al.	2001/0014514 A1	8/2001	Geusic
D840,364 S	2/2019	Ichino et al.	2001/0015343 A1	8/2001	Sprey et al.
10,204,788 B1	2/2019	Ye et al.	2001/0016273 A1	8/2001	Narasimhan et al.
10,211,308 B2	2/2019	Zhu et al.	2001/0017103 A1	8/2001	Takeshita et al.
10,229,833 B2	3/2019	Raisanen et al.	2001/0018267 A1	8/2001	Shinriki et al.
10,229,851 B2	3/2019	Briggs et al.	2001/0019777 A1	9/2001	Tanaka et al.
10,236,177 B1	3/2019	Kohen et al.	2001/0019900 A1	9/2001	Hasegawa
10,249,524 B2	4/2019	den Hartog Besselink et al.	2001/0020715 A1	9/2001	Yamasaki
10,249,577 B2	4/2019	Lee et al.	2001/0021591 A1	9/2001	Srinivasan et al.
10,262,859 B2	4/2019	Margetis et al.	2001/0022215 A1	9/2001	Donohoe
10,269,558 B2	4/2019	Blanquart et al.	2001/0024387 A1	9/2001	Raaijmakers et al.
10,276,355 B2	4/2019	White et al.	2001/0027026 A1	10/2001	Dhindsa et al.
D849,055 S	5/2019	Kneip	2001/0028924 A1	10/2001	Sherman
D849,662 S	5/2019	Rike	2001/0031535 A1	10/2001	Agnello et al.
10,283,353 B2	5/2019	Kobayashi et al.	2001/0031541 A1	10/2001	Madan et al.
10,287,684 B2	5/2019	Yanai et al.	2001/0034097 A1	10/2001	Lim et al.
10,290,508 B1	5/2019	Kubota et al.	2001/0038783 A1	11/2001	Nakashima et al.
10,297,440 B2	5/2019	Yamazaki et al.	2001/0039922 A1	11/2001	Nakahara
RE47,440 E	6/2019	Yudovsky et al.	2001/0039966 A1	11/2001	Walpole et al.
10,312,055 B2	6/2019	Suzuki	2001/0040511 A1	11/2001	Bushner et al.
10,312,129 B2	6/2019	Coomer	2001/0041250 A1	11/2001	Werkhoven et al.
10,319,588 B2	6/2019	Mattinen et al.	2001/0042511 A1	11/2001	Liu et al.
10,322,384 B2	6/2019	Stumpf et al.	2001/0042594 A1	11/2001	Shamouilian et al.
10,332,963 B1	6/2019	Xie	2001/0046765 A1	11/2001	Cappellani et al.
D855,089 S	7/2019	Hopkins	2001/0047761 A1	12/2001	Wijck et al.
10,340,125 B2	7/2019	Winkler	2001/0048981 A1	12/2001	Suzuki
10,340,135 B2	7/2019	Blanquart	2001/0049080 A1	12/2001	Asano
10,343,920 B2	7/2019	Haukka	2001/0049202 A1	12/2001	Maeda et al.
10,347,547 B2	7/2019	Varadarajan et al.	2001/0054388 A1	12/2001	Qian
10,354,873 B2	7/2019	Ko et al.	2002/0000195 A1	1/2002	Bang et al.
10,361,201 B2	7/2019	Xie et al.	2002/0000202 A1	1/2002	Yuda et al.
10,361,366 B2	7/2019	Hakamata et al.	2002/0001971 A1	1/2002	Cho
10,367,080 B2	7/2019	Tang et al.	2002/0001974 A1	1/2002	Chan
10,388,513 B1	8/2019	Blanquart	2002/0001976 A1	1/2002	Danek
10,395,917 B2	8/2019	Niskanen et al.	2002/0005400 A1	1/2002	Gat et al.
10,395,919 B2	8/2019	Masaru et al.	2002/0005943 A1	1/2002	Voinalovich
D859,136 S	9/2019	Tenander et al.	2002/0008270 A1	1/2002	Marsh
10,400,335 B2	9/2019	Ge et al.	2002/0009119 A1	1/2002	Matthew et al.
10,410,943 B2	9/2019	Jiang et al.	2002/0009560 A1	1/2002	Ozono
D864,134 S	10/2019	Watarai et al.	2002/0009861 A1	1/2002	Narwankar et al.
10,428,419 B2	10/2019	Huotari et al.	2002/0011210 A1	1/2002	Satoh et al.
10,435,790 B2	10/2019	Fukazawa et al.	2002/0011211 A1	1/2002	Halpin
D867,867 S	11/2019	Tenander et al.	2002/0011310 A1	1/2002	Kamarehi et al.
10,468,244 B2	11/2019	Li et al.	2002/0013792 A1	1/2002	Imielinski et al.
10,468,251 B2	11/2019	Ishikawa et al.	2002/0014204 A1	2/2002	Pyo
10,483,154 B1	11/2019	Smith et al.	2002/0014483 A1	2/2002	Suzuki et al.
10,510,871 B1	12/2019	More et al.	2002/0016829 A1	2/2002	Defosse
10,529,554 B2	1/2020	Ishikawa et al.	2002/0020429 A1	2/2002	Selbrede et al.
D876,504 S	2/2020	Lee et al.	2002/0022347 A1	2/2002	Park et al.
			2002/0023677 A1	2/2002	Zheng
			2002/0025688 A1	2/2002	Kato
			2002/0027945 A1	3/2002	Hirano et al.
			2002/0030047 A1	3/2002	Shao et al.

(56)

References Cited

U.S. PATENT DOCUMENTS

2002/0031644	A1	3/2002	Malofsky et al.	2002/0197849	A1	12/2002	Mandal
2002/0041931	A1	4/2002	Suntola et al.	2003/0000647	A1	1/2003	Yudovsky et al.
2002/0043337	A1	4/2002	Goodman et al.	2003/0002562	A1	1/2003	Yerlikaya et al.
2002/0045336	A1	4/2002	Locati et al.	2003/0003607	A1	1/2003	Kagoshima
2002/0048634	A1	4/2002	Basceri	2003/0003635	A1	1/2003	Paranjpe et al.
2002/0050648	A1	5/2002	Kishida et al.	2003/0003696	A1	1/2003	Gelatos et al.
2002/0062633	A1	5/2002	Denker et al.	2003/0003719	A1	1/2003	Lim et al.
2002/0064592	A1	5/2002	Datta et al.	2003/0008528	A1	1/2003	Xia et al.
2002/0064598	A1	5/2002	Wang et al.	2003/0010355	A1	1/2003	Nowak et al.
2002/0066532	A1	6/2002	Shih et al.	2003/0010451	A1	1/2003	Tzu
2002/0068458	A1	6/2002	Chiang et al.	2003/0010452	A1	1/2003	Park et al.
2002/0069222	A1	6/2002	McNeely	2003/0012632	A1	1/2003	Saeki
2002/0073922	A1	6/2002	Frankel et al.	2003/0013314	A1	1/2003	Ying et al.
2002/0073923	A1	6/2002	Saito et al.	2003/0015141	A1	1/2003	Takagi
2002/0076490	A1	6/2002	Chiang et al.	2003/0015294	A1	1/2003	Wang
2002/0076507	A1	6/2002	Chiang et al.	2003/0015596	A1	1/2003	Evans
2002/0076944	A1	6/2002	Wang et al.	2003/0017265	A1	1/2003	Basceri et al.
2002/0078893	A1	6/2002	Van Os et al.	2003/0017266	A1	1/2003	Basceri et al.
2002/0079714	A1	6/2002	Soucy et al.	2003/0017268	A1	1/2003	Hu
2002/0081826	A1	6/2002	Rotondaro et al.	2003/0019428	A1	1/2003	Ku et al.
2002/0086501	A1	7/2002	O'Donnell et al.	2003/0019580	A1	1/2003	Strang
2002/0088542	A1	7/2002	Nishikawa et al.	2003/0022468	A1	1/2003	Shioya et al.
2002/0090735	A1	7/2002	Kishkovich et al.	2003/0022523	A1	1/2003	Irino et al.
2002/0094378	A1	7/2002	O'Donnell et al.	2003/0023338	A1	1/2003	Chin et al.
2002/0094388	A1	7/2002	Fonash et al.	2003/0024901	A1	2/2003	Ishikawa
2002/0096211	A1	7/2002	Zheng	2003/0025146	A1	2/2003	Narwankar et al.
2002/0098627	A1	7/2002	Pomarede et al.	2003/0026904	A1	2/2003	Yadav et al.
2002/0099470	A1	7/2002	Zinger et al.	2003/0027431	A1	2/2003	Sneh et al.
2002/0100418	A1	8/2002	Sandhu et al.	2003/0029303	A1	2/2003	Hasegawa et al.
2002/0104481	A1	8/2002	Chiang et al.	2003/0029381	A1	2/2003	Nishibayashi
2002/0104751	A1*	8/2002	Drewery H01J 37/32477 204/192.1	2003/0029475	A1	2/2003	Hua et al.
2002/0108670	A1	8/2002	Baker et al.	2003/0032297	A1	2/2003	Lindstrom et al.
2002/0108714	A1	8/2002	Doering et al.	2003/0035002	A1	2/2003	Moles
2002/0109115	A1	8/2002	Cederstav et al.	2003/0035705	A1	2/2003	Johnson
2002/0110695	A1	8/2002	Yang et al.	2003/0036272	A1	2/2003	Shamouilian et al.
2002/0110991	A1	8/2002	Li	2003/0037800	A1	2/2003	Bailey et al.
2002/0112114	A1	8/2002	Blair et al.	2003/0040120	A1	2/2003	Allen et al.
2002/0114886	A1	8/2002	Chou et al.	2003/0040158	A1	2/2003	Saitoh
2002/0115252	A1	8/2002	Haukka et al.	2003/0040196	A1	2/2003	Lim et al.
2002/0117113	A1	8/2002	Tsuruno et al.	2003/0040841	A1	2/2003	Nasr et al.
2002/0122885	A1	9/2002	Ahn	2003/0041971	A1	3/2003	Kido et al.
2002/0123200	A1	9/2002	Yamamoto et al.	2003/0042419	A1	3/2003	Katsumata et al.
2002/0123230	A1	9/2002	Hubacek	2003/0045961	A1	3/2003	Nakao
2002/0123237	A1	9/2002	Nguyen et al.	2003/0049372	A1	3/2003	Cook et al.
2002/0124883	A1	9/2002	Zheng	2003/0049375	A1	3/2003	Nguyen et al.
2002/0124906	A1	9/2002	Suzuki et al.	2003/0049499	A1	3/2003	Murakawa et al.
2002/0127350	A1	9/2002	Ishikawa et al.	2003/0049580	A1	3/2003	Goodman
2002/0129768	A1	9/2002	Carpenter et al.	2003/0049937	A1	3/2003	Suzuki
2002/0132408	A1	9/2002	Ma et al.	2003/0054670	A1	3/2003	Wang et al.
2002/0134511	A1	9/2002	Ushioda et al.	2003/0057848	A1	3/2003	Yuasa et al.
2002/0136214	A1	9/2002	Do et al.	2003/0059535	A1	3/2003	Luo et al.
2002/0136909	A1	9/2002	Yang	2003/0059980	A1	3/2003	Chen et al.
2002/0139775	A1	10/2002	Chang	2003/0062359	A1	4/2003	Ho et al.
2002/0146512	A1	10/2002	Rossmann	2003/0065413	A1	4/2003	Liteplo et al.
2002/0151327	A1	10/2002	Levitt	2003/0066482	A1	4/2003	Pokharna et al.
2002/0152244	A1	10/2002	Dean et al.	2003/0066541	A1	4/2003	Sun et al.
2002/0155219	A1	10/2002	Wang et al.	2003/0066826	A1	4/2003	Lee et al.
2002/0155708	A1	10/2002	Lo et al.	2003/0070617	A1	4/2003	Kim et al.
2002/0157611	A1	10/2002	Bondestam et al.	2003/0071015	A1	4/2003	Chinn et al.
2002/0160112	A1	10/2002	Sakai et al.	2003/0072882	A1	4/2003	Niinisto et al.
2002/0164420	A1	11/2002	Derderian et al.	2003/0075925	A1	4/2003	Lindfors et al.
2002/0164423	A1	11/2002	Chiang et al.	2003/0077857	A1	4/2003	Xia et al.
2002/0168870	A1	11/2002	Matsuki	2003/0077883	A1	4/2003	Ohtake
2002/0170676	A1	11/2002	Mitrovic et al.	2003/0082296	A1	5/2003	Elers et al.
2002/0172768	A1	11/2002	Endo et al.	2003/0082307	A1	5/2003	Chung et al.
2002/0174106	A1	11/2002	Martin	2003/0085663	A1	5/2003	Horsky
2002/0179011	A1	12/2002	Jonnalagadda et al.	2003/0091938	A1	5/2003	Fairbairn et al.
2002/0181612	A1	12/2002	Warble et al.	2003/0094133	A1	5/2003	Yoshidome et al.
2002/0184111	A1	12/2002	Swanson	2003/0101938	A1	6/2003	Ronsse et al.
2002/0187650	A1	12/2002	Blalock et al.	2003/0109107	A1	6/2003	Hsieh et al.
2002/0187656	A1	12/2002	Tan et al.	2003/0109951	A1	6/2003	Hsiung et al.
2002/0188376	A1	12/2002	Derderian et al.	2003/0111013	A1	6/2003	Oosterlaken et al.
2002/0192370	A1	12/2002	Metzner et al.	2003/0111963	A1	6/2003	Tolmachev et al.
2002/0197402	A1	12/2002	Chiang et al.	2003/0113995	A1	6/2003	Xia et al.
				2003/0116087	A1	6/2003	Nguyen
				2003/0121608	A1	7/2003	Chen
				2003/0124792	A1	7/2003	Jeon et al.
				2003/0124818	A1	7/2003	Luo et al.
				2003/0124820	A1	7/2003	Johnsgard et al.

(56)

References Cited

U.S. PATENT DOCUMENTS

2003/0124842	A1	7/2003	Hytros et al.	2004/0013818	A1	1/2004	Moon et al.
2003/0127049	A1	7/2003	Han et al.	2004/0015300	A1	1/2004	Ganguli et al.
2003/0133854	A1	7/2003	Tabata et al.	2004/0016637	A1	1/2004	Yang
2003/0134038	A1	7/2003	Paranjpe	2004/0018304	A1	1/2004	Chung et al.
2003/0140851	A1	7/2003	Janakiraman et al.	2004/0018307	A1	1/2004	Park et al.
2003/0141527	A1	7/2003	Joo et al.	2004/0018723	A1	1/2004	Byun et al.
2003/0141820	A1	7/2003	White et al.	2004/0018750	A1	1/2004	Sophie et al.
2003/0143328	A1	7/2003	Chen	2004/0023125	A1	2/2004	Nozawa et al.
2003/0145789	A1	8/2003	Bauch et al.	2004/0023516	A1	2/2004	Londergan et al.
2003/0149506	A1	8/2003	Haanstra et al.	2004/0025786	A1	2/2004	Kontani et al.
2003/0150386	A1	8/2003	Shimada	2004/0025787	A1	2/2004	Selbrede et al.
2003/0153177	A1	8/2003	Tepman et al.	2004/0026372	A1	2/2004	Takenaka et al.
2003/0153186	A1	8/2003	Bar-Gadda	2004/0029052	A1	2/2004	Park et al.
2003/0157345	A1	8/2003	Beldi et al.	2004/0031564	A1	2/2004	Gottscho et al.
2003/0157432	A1	8/2003	Rottsegge	2004/0035358	A1	2/2004	Basceri et al.
2003/0157436	A1	8/2003	Manger et al.	2004/0036129	A1	2/2004	Forbes et al.
2003/0159653	A1	8/2003	Dando et al.	2004/0037339	A1	2/2004	Watson et al.
2003/0159656	A1	8/2003	Tan	2004/0037675	A1	2/2004	Zinger et al.
2003/0162412	A1	8/2003	Chung	2004/0038525	A1	2/2004	Meng et al.
2003/0168001	A1	9/2003	Sneh	2004/0043149	A1	3/2004	Gordon et al.
2003/0168008	A1	9/2003	Ohmi et al.	2004/0043544	A1	3/2004	Asai et al.
2003/0168012	A1	9/2003	Tamura et al.	2004/0048439	A1	3/2004	Soman
2003/0168174	A1	9/2003	Foree	2004/0048452	A1	3/2004	Sugawara et al.
2003/0168699	A1	9/2003	Honda	2004/0048492	A1	3/2004	Ishikawa et al.
2003/0168750	A1	9/2003	Basceri et al.	2004/0050325	A1	3/2004	Samoilov
2003/0168948	A1	9/2003	Yamagishi et al.	2004/0050496	A1	3/2004	Iwai et al.
2003/0170153	A1	9/2003	Bar-Gadda	2004/0052972	A1	3/2004	Schmitt
2003/0170583	A1	9/2003	Nakashima	2004/0056017	A1	3/2004	Renken
2003/0170945	A1	9/2003	Igeta et al.	2004/0062081	A1	4/2004	Drewes
2003/0173030	A1	9/2003	Ishii et al.	2004/0063289	A1	4/2004	Ohta
2003/0173490	A1	9/2003	Lappen	2004/0065255	A1	4/2004	Yang et al.
2003/0176074	A1	9/2003	Paterson et al.	2004/0069226	A1	4/2004	Yoshida et al.
2003/0178145	A1	9/2003	Anderson et al.	2004/0071897	A1	4/2004	Verplancken et al.
2003/0180458	A1	9/2003	Sneh	2004/0077182	A1	4/2004	Lim et al.
2003/0183156	A1	10/2003	Dando	2004/0079286	A1	4/2004	Lindfors
2003/0183856	A1	10/2003	Wieczorek et al.	2004/0079960	A1	4/2004	Shakuda
2003/0188682	A1	10/2003	Tois et al.	2004/0080697	A1	4/2004	Song
2003/0188685	A1	10/2003	Wang	2004/0082171	A1	4/2004	Shin et al.
2003/0190804	A1	10/2003	Glenn et al.	2004/0083961	A1	5/2004	Basceri
2003/0192875	A1	10/2003	Bieker et al.	2004/0083964	A1	5/2004	Ingle et al.
2003/0198587	A1	10/2003	Kaloyeros	2004/0083975	A1	5/2004	Tong et al.
2003/0200926	A1	10/2003	Dando et al.	2004/0087141	A1	5/2004	Ramanathan et al.
2003/0201541	A1	10/2003	Kim	2004/0087168	A1	5/2004	Granneman et al.
2003/0205096	A1	11/2003	Gehner et al.	2004/0089078	A1	5/2004	Gehner et al.
2003/0205202	A1	11/2003	Funaki et al.	2004/0089236	A1	5/2004	Yokogawa et al.
2003/0205327	A1	11/2003	Howald et al.	2004/0092073	A1	5/2004	Cabral et al.
2003/0207032	A1	11/2003	Ahn et al.	2004/0092120	A1	5/2004	Wicker
2003/0209323	A1	11/2003	Yokogaki	2004/0093963	A1	5/2004	Gehner et al.
2003/0209326	A1	11/2003	Lee et al.	2004/0094206	A1	5/2004	Ishida
2003/0209746	A1	11/2003	Horii	2004/0094402	A1	5/2004	Gopalraja
2003/0210901	A1	11/2003	Donald et al.	2004/0095074	A1	5/2004	Ishii et al.
2003/0211735	A1	11/2003	Rossman	2004/0099213	A1	5/2004	Adomaitis et al.
2003/0213435	A1	11/2003	Okuda et al.	2004/0099635	A1	5/2004	Nishikawa
2003/0213560	A1	11/2003	Wang et al.	2004/0101622	A1	5/2004	Park et al.
2003/0213562	A1	11/2003	Gondhalekar et al.	2004/0103914	A1	6/2004	Cheng et al.
2003/0215963	A1	11/2003	AmRhein et al.	2004/0105738	A1	6/2004	Ahn et al.
2003/0217915	A1	11/2003	Ouellet	2004/0106249	A1	6/2004	Huotari
2003/0219972	A1	11/2003	Green	2004/0115936	A1	6/2004	DePetrillo et al.
2003/0221780	A1	12/2003	Lei et al.	2004/0118342	A1	6/2004	Cheng et al.
2003/0226840	A1	12/2003	Dalton	2004/0121620	A1	6/2004	Pomarede et al.
2003/0228772	A1	12/2003	Cowans	2004/0124131	A1	7/2004	Aitchison
2003/0230986	A1	12/2003	Horsky et al.	2004/0124549	A1	7/2004	Curran
2003/0231698	A1	12/2003	Yamaguchi	2004/0126213	A1	7/2004	Pelzmann et al.
2003/0232138	A1	12/2003	Tuominen et al.	2004/0126929	A1	7/2004	Tang et al.
2003/0232491	A1	12/2003	Yamaguchi	2004/0126990	A1	7/2004	Ohta
2003/0232511	A1	12/2003	Metzner et al.	2004/0127069	A1	7/2004	Yamazaki et al.
2003/0234371	A1	12/2003	Ziegler	2004/0129211	A1	7/2004	Blonigan et al.
2004/0002224	A1	1/2004	Chono et al.	2004/0129671	A1	7/2004	Ji et al.
2004/0005147	A1	1/2004	Wang et al.	2004/0134429	A1	7/2004	Yamanaka
2004/0005753	A1	1/2004	Kostamo et al.	2004/0137756	A1	7/2004	Li et al.
2004/0009307	A1	1/2004	Koh et al.	2004/0142577	A1	7/2004	Sugawara et al.
2004/0009679	A1	1/2004	Yeo et al.	2004/0144311	A1	7/2004	Chen
2004/0010772	A1	1/2004	McKenna et al.	2004/0144323	A1	7/2004	Kai
2004/0011504	A1	1/2004	Ku et al.	2004/0144980	A1	7/2004	Ahn et al.
2004/0013577	A1	1/2004	Ganguli et al.	2004/0146644	A1	7/2004	Xia et al.
				2004/0151844	A1	8/2004	Zhang et al.
				2004/0151845	A1	8/2004	Nguyen et al.
				2004/0152287	A1	8/2004	Sherrill et al.
				2004/0159343	A1	8/2004	Shimbara et al.

(56)

References Cited

U.S. PATENT DOCUMENTS

2004/0168627	A1	9/2004	Conley et al.	2005/0054198	A1	3/2005	Um
2004/0168742	A1	9/2004	Kim et al.	2005/0054228	A1	3/2005	March
2004/0168769	A1	9/2004	Matsuoka et al.	2005/0056218	A1	3/2005	Sun et al.
2004/0169032	A1	9/2004	Murayama et al.	2005/0056780	A1	3/2005	Miller et al.
2004/0185177	A1	9/2004	Basceri et al.	2005/0059261	A1	3/2005	Basceri et al.
2004/0187304	A1	9/2004	Chen et al.	2005/0059262	A1	3/2005	Yin et al.
2004/0187777	A1	9/2004	Okamoto et al.	2005/0059264	A1	3/2005	Cheung
2004/0187784	A1	9/2004	Sferlazzo	2005/0061964	A1	3/2005	Nagano et al.
2004/0187790	A1	9/2004	Bader	2005/0063451	A1	3/2005	Abe et al.
2004/0187928	A1	9/2004	Ambrosina	2005/0064207	A1	3/2005	Senzaki et al.
2004/0198069	A1	10/2004	Metzner et al.	2005/0064719	A1	3/2005	Liu
2004/0200499	A1	10/2004	Harvey et al.	2005/0066893	A1	3/2005	Soininen
2004/0202786	A1	10/2004	Wongsenakhum et al.	2005/0069651	A1	3/2005	Miyoshi
2004/0203251	A1	10/2004	Kawaguchi et al.	2005/0070123	A1	3/2005	Hirano
2004/0206305	A1	10/2004	Choi et al.	2005/0070128	A1	3/2005	Xia et al.
2004/0208228	A1	10/2004	Hashikura et al.	2005/0070729	A1	3/2005	Kiyomori et al.
2004/0209477	A1	10/2004	Buxbaum et al.	2005/0072357	A1	4/2005	Shero et al.
2004/0211357	A1	10/2004	Gadgil	2005/0074576	A1	4/2005	Chaiken et al.
2004/0212947	A1	10/2004	Nguyen	2005/0074983	A1	4/2005	Shinriki et al.
2004/0213921	A1	10/2004	Leu	2005/0079124	A1	4/2005	Sanderson
2004/0214399	A1	10/2004	Ahn et al.	2005/0079691	A1	4/2005	Kim et al.
2004/0214445	A1	10/2004	Shimizu et al.	2005/0092247	A1	5/2005	Schmidt
2004/0217217	A1	11/2004	Han et al.	2005/0092249	A1	5/2005	Kilpela et al.
2004/0219793	A1	11/2004	Hishiya et al.	2005/0092733	A1	5/2005	Ito et al.
2004/0220699	A1	11/2004	Heden et al.	2005/0095770	A1	5/2005	Kumagai et al.
2004/0221807	A1	11/2004	Verghese et al.	2005/0095779	A1	5/2005	Park et al.
2004/0221808	A1	11/2004	Kawano	2005/0095859	A1	5/2005	Chen et al.
2004/0223893	A1	11/2004	Tabata et al.	2005/0098107	A1	5/2005	Du Bois et al.
2004/0226515	A1	11/2004	Yendler et al.	2005/0100669	A1	5/2005	Kools et al.
2004/0228968	A1	11/2004	Basceri	2005/0101154	A1	5/2005	Huang
2004/0231600	A1	11/2004	Lee	2005/0101843	A1	5/2005	Quinn et al.
2004/0231799	A1	11/2004	Lee et al.	2005/0106762	A1	5/2005	Chakrapani et al.
2004/0238523	A1	12/2004	Kuibira et al.	2005/0106893	A1	5/2005	Wilk
2004/0241322	A1	12/2004	Basceri et al.	2005/0107627	A1	5/2005	Dussarrat et al.
2004/0241998	A1	12/2004	Hanson	2005/0109461	A1	5/2005	Sun
2004/0245091	A1	12/2004	Karim et al.	2005/0110069	A1	5/2005	Kil et al.
2004/0247779	A1	12/2004	Selvamanickam et al.	2005/0112282	A1	5/2005	Gordon et al.
2004/0250600	A1	12/2004	Bevers et al.	2005/0115946	A1	6/2005	Shim et al.
2004/0253867	A1	12/2004	Matsumoto	2005/0118804	A1	6/2005	Byun et al.
2004/0261492	A1	12/2004	Zarkar et al.	2005/0118837	A1	6/2005	Todd
2004/0261712	A1	12/2004	Hayashi et al.	2005/0120805	A1	6/2005	Lane
2004/0261946	A1	12/2004	Endoh et al.	2005/0120962	A1	6/2005	Ushioda et al.
2004/0266011	A1	12/2004	Lee et al.	2005/0121145	A1	6/2005	Du Bois et al.
2005/0000428	A1	1/2005	Shero et al.	2005/0123690	A1	6/2005	Derderian et al.
2005/0001062	A1	1/2005	McCracken et al.	2005/0130427	A1	6/2005	Seok-Jun
2005/0003089	A1	1/2005	Won et al.	2005/0132957	A1	6/2005	El-Raghy
2005/0003600	A1	1/2005	Kasai et al.	2005/0133160	A1	6/2005	Kennedy et al.
2005/0003662	A1	1/2005	Jurisch et al.	2005/0133161	A1	6/2005	Carpenter et al.
2005/0008799	A1	1/2005	Tomiyasu et al.	2005/0136188	A1	6/2005	Chang
2005/0009325	A1	1/2005	Chung et al.	2005/0139160	A1	6/2005	Lei et al.
2005/0016470	A1	1/2005	Kang et al.	2005/0141591	A1	6/2005	Sakano
2005/0016956	A1	1/2005	Liu et al.	2005/0142361	A1	6/2005	Nakanishi
2005/0017272	A1	1/2005	Yamashita et al.	2005/0145338	A1	7/2005	Park et al.
2005/0019026	A1	1/2005	Wang et al.	2005/0148162	A1	7/2005	Chen et al.
2005/0019494	A1	1/2005	Moghadam et al.	2005/0150601	A1	7/2005	Srivastava
2005/0019960	A1	1/2005	Lee et al.	2005/0151184	A1	7/2005	Lee et al.
2005/0020071	A1	1/2005	Sonobe et al.	2005/0153571	A1	7/2005	Senzaki
2005/0023231	A1	2/2005	Huang et al.	2005/0160987	A1	7/2005	Kasai et al.
2005/0023624	A1	2/2005	Ahn et al.	2005/0161434	A1	7/2005	Sugawara et al.
2005/0026402	A1	2/2005	Jurgensen	2005/0172895	A1	8/2005	Kijima et al.
2005/0033075	A1	2/2005	Chi et al.	2005/0173003	A1	8/2005	Laverdiere et al.
2005/0034664	A1	2/2005	Koh et al.	2005/0175789	A1	8/2005	Helms
2005/0034674	A1	2/2005	Ono	2005/0178333	A1	8/2005	Loke et al.
2005/0037154	A1	2/2005	Koh et al.	2005/0181535	A1	8/2005	Yun et al.
2005/0037578	A1	2/2005	Chen et al.	2005/0181555	A1	8/2005	Haukka et al.
2005/0037610	A1	2/2005	Cha	2005/0183827	A1	8/2005	White et al.
2005/0037619	A1	2/2005	Granneman et al.	2005/0186688	A1	8/2005	Basceri
2005/0040144	A1	2/2005	Sellers	2005/0187647	A1	8/2005	Wang et al.
2005/0042778	A1	2/2005	Peukert	2005/0191828	A1	9/2005	Al-Bayati et al.
2005/0046825	A1	3/2005	Powell et al.	2005/0193948	A1	9/2005	Oohirabaru et al.
2005/0048797	A1	3/2005	Fukazawa	2005/0193952	A1	9/2005	Goodman et al.
2005/0051093	A1	3/2005	Makino et al.	2005/0199013	A1	9/2005	Vandroux et al.
2005/0051100	A1	3/2005	Chiang et al.	2005/0199342	A1	9/2005	Shajii et al.
2005/0051854	A1	3/2005	Cabral et al.	2005/0201908	A1	9/2005	Nakamura et al.
2005/0054175	A1	3/2005	Bauer	2005/0208217	A1	9/2005	Shinriki et al.
				2005/0208219	A1	9/2005	Basceri
				2005/0208718	A1	9/2005	Lim et al.
				2005/0211167	A1	9/2005	Gunji
				2005/0211384	A1	9/2005	Hayashi

(56)

References Cited

U.S. PATENT DOCUMENTS

2005/0212119	A1	9/2005	Shero	2006/0060930	A1	3/2006	Metz et al.
2005/0214457	A1	9/2005	Schmitt et al.	2006/0062910	A1	3/2006	Meiere
2005/0214458	A1	9/2005	Meiere	2006/0063346	A1	3/2006	Lee et al.
2005/0208778	A1	10/2005	Li	2006/0068097	A1	3/2006	Yamasaki et al.
2005/0218462	A1	10/2005	Ahn et al.	2006/0068104	A1	3/2006	Ishizaka
2005/0221021	A1	10/2005	Strang	2006/0068121	A1	3/2006	Lee et al.
2005/0221618	A1	10/2005	AmRhein et al.	2006/0068125	A1	3/2006	Radhakrishnan
2005/0223982	A1	10/2005	Park et al.	2006/0081558	A1	4/2006	Collins et al.
2005/0223994	A1	10/2005	Blomiley et al.	2006/0087638	A1	4/2006	Hirayanagi
2005/0227502	A1	10/2005	Schmitt et al.	2006/0090702	A1	5/2006	Koo et al.
2005/0229848	A1	10/2005	Shinriki	2006/0093756	A1	5/2006	Rajagopalan et al.
2005/0229849	A1	10/2005	Silvetti et al.	2006/0094236	A1	5/2006	Elkins et al.
2005/0229972	A1	10/2005	Hoshi et al.	2006/0096540	A1	5/2006	Choi
2005/0233477	A1	10/2005	Yamazaki et al.	2006/0099782	A1	5/2006	Ritenour
2005/0238807	A1	10/2005	Lin et al.	2006/0102968	A1	5/2006	Bojarczuk et al.
2005/0241176	A1	11/2005	Shero et al.	2006/0105566	A1	5/2006	Waldfried et al.
2005/0241763	A1	11/2005	Huang et al.	2006/0107898	A1	5/2006	Blomberg
2005/0241765	A1	11/2005	Dhindsa et al.	2006/0108221	A1	5/2006	Goodwin et al.
2005/0245058	A1	11/2005	Lee et al.	2006/0108331	A1	5/2006	Nozawa et al.
2005/0249876	A1	11/2005	Kawahara et al.	2006/0110930	A1	5/2006	Senzaki
2005/0250340	A1	11/2005	Chen et al.	2006/0110934	A1	5/2006	Fukuchi
2005/0251990	A1	11/2005	Choi	2006/0111037	A1*	5/2006	Poirier F16L 37/26 454/270
2005/0252447	A1	11/2005	Zhao et al.	2006/0113038	A1	6/2006	Gondhalekar et al.
2005/0252449	A1	11/2005	Nguyen et al.	2006/0113675	A1	6/2006	Chang et al.
2005/0252455	A1	11/2005	Moriya et al.	2006/0113806	A1	6/2006	Tsuji et al.
2005/0253061	A1	11/2005	Cameron et al.	2006/0118240	A1	6/2006	Holber et al.
2005/0255257	A1	11/2005	Choi et al.	2006/0118241	A1	6/2006	Ohmi et al.
2005/0255327	A1	11/2005	Chaney et al.	2006/0125099	A1	6/2006	Gordon et al.
2005/0258280	A1	11/2005	Goto et al.	2006/0127067	A1	6/2006	Wintenberger et al.
2005/0260347	A1	11/2005	Narwankar et al.	2006/0128142	A1	6/2006	Whelan et al.
2005/0260837	A1	11/2005	Walther et al.	2006/0128168	A1	6/2006	Ahn et al.
2005/0260850	A1	11/2005	Loke	2006/0130751	A1	6/2006	Volfovski et al.
2005/0263072	A1	12/2005	Balasubramanian et al.	2006/0130767	A1	6/2006	Herchen
2005/0263075	A1	12/2005	Wang et al.	2006/0137608	A1	6/2006	Choi et al.
2005/0263719	A1	12/2005	Ohdaira et al.	2006/0137609	A1	6/2006	Puchacz et al.
2005/0263932	A1	12/2005	Heugel	2006/0141155	A1	6/2006	Gordon et al.
2005/0268856	A1	12/2005	Miller et al.	2006/0144820	A1	7/2006	Sawin et al.
2005/0271812	A1	12/2005	Myo et al.	2006/0147626	A1	7/2006	Blomberg
2005/0271813	A1	12/2005	Kher et al.	2006/0148151	A1	7/2006	Murthy et al.
2005/0272247	A1	12/2005	Ikeda et al.	2006/0148180	A1	7/2006	Ahn et al.
2005/0274323	A1	12/2005	Seidel et al.	2006/0151117	A1	7/2006	Kasanami et al.
2005/0276928	A1	12/2005	Okumura et al.	2006/0154424	A1	7/2006	Yang et al.
2005/0277271	A1	12/2005	Beintner	2006/0156981	A1	7/2006	Fondurulia
2005/0282101	A1	12/2005	Adachi	2006/0162658	A1	7/2006	Weidman
2005/0282350	A1	12/2005	Chou et al.	2006/0162661	A1	7/2006	Jung et al.
2005/0284573	A1	12/2005	Egley et al.	2006/0162863	A1	7/2006	Kim et al.
2005/0284991	A1	12/2005	Saez	2006/0163612	A1	7/2006	Kouvetakis et al.
2005/0285097	A1	12/2005	Shang et al.	2006/0163683	A1	7/2006	Roth et al.
2005/0287725	A1	12/2005	Kitagawa	2006/0165892	A1	7/2006	Weidman
2005/0287771	A1	12/2005	Seamons et al.	2006/0166428	A1	7/2006	Kamioka
2006/0000411	A1	1/2006	Seo	2006/0172531	A1	8/2006	Lin et al.
2006/0006538	A1	1/2006	Allman et al.	2006/0175669	A1	8/2006	Kim et al.
2006/0009044	A1	1/2006	Igeta et al.	2006/0177855	A1	8/2006	Utermohlen
2006/0013674	A1	1/2006	Elliott et al.	2006/0182885	A1	8/2006	Lei et al.
2006/0013946	A1	1/2006	Park et al.	2006/0185589	A1	8/2006	Zehavi et al.
2006/0014384	A1	1/2006	Lee et al.	2006/0188360	A1	8/2006	Bonora et al.
2006/0014397	A1	1/2006	Seamons et al.	2006/0191555	A1	8/2006	Yoshida et al.
2006/0016783	A1	1/2006	Wu et al.	2006/0193979	A1	8/2006	Meiere et al.
2006/0019033	A1	1/2006	Muthukrishnan et al.	2006/0193980	A1	8/2006	Hasegawa
2006/0019502	A1	1/2006	Park et al.	2006/0196418	A1	9/2006	Lindfors et al.
2006/0021572	A1	2/2006	Wolden	2006/0196420	A1	9/2006	Ushakov et al.
2006/0021573	A1	2/2006	Monsma et al.	2006/0196421	A1	9/2006	Ronsse et al.
2006/0021703	A1	2/2006	Umotoy et al.	2006/0199357	A1	9/2006	Wan et al.
2006/0024439	A2	2/2006	Tuominen et al.	2006/0205194	A1	9/2006	Bauer
2006/0026314	A1	2/2006	Franchuk et al.	2006/0205223	A1	9/2006	Smayling
2006/0032443	A1	2/2006	Hasebe et al.	2006/0205231	A1	9/2006	Chou et al.
2006/0040054	A1	2/2006	Pearlstein et al.	2006/0208215	A1	9/2006	Metzner et al.
2006/0040508	A1	2/2006	Ji	2006/0211243	A1	9/2006	Ishizaka et al.
2006/0046518	A1	3/2006	Hill et al.	2006/0211259	A1	9/2006	Maes
2006/0048710	A1	3/2006	Horiguchi et al.	2006/0213437	A1	9/2006	Ishizaka et al.
2006/0051505	A1	3/2006	Kortshagen et al.	2006/0213439	A1	9/2006	Ishizaka
2006/0051520	A1	3/2006	Behle et al.	2006/0216942	A1	9/2006	Kim et al.
2006/0051925	A1	3/2006	Ahn et al.	2006/0219169	A1	10/2006	Chen et al.
2006/0057799	A1	3/2006	Horiguchi et al.	2006/0219361	A1	10/2006	Wang et al.
2006/0057828	A1	3/2006	Omura	2006/0219363	A1	10/2006	Matsumoto et al.
				2006/0223301	A1	10/2006	Vanhaelemeersch et al.
				2006/0223337	A1	10/2006	Ahn et al.
				2006/0226117	A1	10/2006	Bertram et al.

(56)

References Cited

U.S. PATENT DOCUMENTS

2006/0228496	A1	10/2006	Choi	2007/0056850	A1	3/2007	Ye et al.
2006/0228863	A1	10/2006	Zhang et al.	2007/0059948	A1	3/2007	Metzner et al.
2006/0228888	A1	10/2006	Lee et al.	2007/0062439	A1	3/2007	Wada et al.
2006/0228898	A1	10/2006	Wajda	2007/0062453	A1	3/2007	Ishikawa
2006/0236934	A1	10/2006	Choi et al.	2007/0062646	A1	3/2007	Ogawa et al.
2006/0240187	A1	10/2006	Weidman	2007/0065578	A1	3/2007	McDougall
2006/0240574	A1	10/2006	Yoshie	2007/0066010	A1	3/2007	Ando
2006/0240662	A1	10/2006	Conley et al.	2007/0066038	A1	3/2007	Sadjadi et al.
2006/0247404	A1	11/2006	Todd	2007/0066079	A1	3/2007	Kolster et al.
2006/0249253	A1	11/2006	Dando	2007/0066084	A1	3/2007	Wajda et al.
2006/0251827	A1	11/2006	Nowak	2007/0074665	A1	4/2007	Chacin et al.
2006/0252228	A1	11/2006	Jeng	2007/0077355	A1	4/2007	Chacin et al.
2006/0252351	A1	11/2006	Kundracik	2007/0082132	A1	4/2007	Shinriki
2006/0254514	A1	11/2006	Kang et al.	2007/0082500	A1	4/2007	Norman et al.
2006/0257563	A1	11/2006	Doh et al.	2007/0082508	A1	4/2007	Chiang et al.
2006/0257584	A1	11/2006	Derderian et al.	2007/0084405	A1	4/2007	Kim
2006/0258078	A1	11/2006	Lee et al.	2007/0087296	A1	4/2007	Kim et al.
2006/0258173	A1	11/2006	Xiao et al.	2007/0087533	A1*	4/2007	Nishikawa C23C 16/45591 438/478
2006/0260545	A1	11/2006	Ramaswamy et al.	2007/0087579	A1	4/2007	Kitayama et al.
2006/0263522	A1	11/2006	Byun	2007/0089670	A1	4/2007	Ikedo
2006/0263540	A1	11/2006	Ramaswamy et al.	2007/0095283	A1	5/2007	Galewski
2006/0264060	A1	11/2006	Ramaswamy et al.	2007/0095286	A1	5/2007	Baek et al.
2006/0264066	A1	11/2006	Bartholomew	2007/0096194	A1	5/2007	Streck et al.
2006/0266289	A1	11/2006	Vergheze et al.	2007/0098527	A1	5/2007	Hall et al.
2006/0269690	A1	11/2006	Watanabe et al.	2007/0107845	A1	5/2007	Ishizawa et al.
2006/0269692	A1	11/2006	Balseanu	2007/0111470	A1	5/2007	Smythe
2006/0275710	A1	12/2006	Yamazaki et al.	2007/0111545	A1	5/2007	Lee et al.
2006/0275933	A1	12/2006	Du Bois et al.	2007/0113788	A1	5/2007	Nozawa et al.
2006/0278524	A1	12/2006	Stowell	2007/0116872	A1	5/2007	Li et al.
2006/0283629	A1	12/2006	Kikuchi et al.	2007/0116873	A1	5/2007	Li et al.
2006/0286774	A1	12/2006	Singh et al.	2007/0116887	A1	5/2007	Faguet
2006/0286775	A1	12/2006	Singh et al.	2007/0116888	A1	5/2007	Faguet
2006/0286817	A1	12/2006	Kato et al.	2007/0119370	A1*	5/2007	Ma H01L 21/76873 118/723 E
2006/0286818	A1	12/2006	Wang et al.	2007/0120275	A1	5/2007	Liu
2006/0286819	A1	12/2006	Seutter	2007/0123037	A1	5/2007	Lee et al.
2006/0291982	A1	12/2006	Tanaka	2007/0123189	A1	5/2007	Saito et al.
2006/0292310	A1	12/2006	Le et al.	2007/0125762	A1	6/2007	Cui et al.
2006/0292845	A1	12/2006	Chiang et al.	2007/0128538	A1	6/2007	Fairbairn et al.
2007/0004204	A1	1/2007	Fukazawa et al.	2007/0128570	A1	6/2007	Goto et al.
2007/0006806	A1	1/2007	Imai	2007/0128858	A1	6/2007	Haukka et al.
2007/0010072	A1	1/2007	Bailey et al.	2007/0128876	A1	6/2007	Fukiage
2007/0012402	A1	1/2007	Sneh	2007/0128888	A1	6/2007	Goto et al.
2007/0014919	A1	1/2007	Hamalainen et al.	2007/0129621	A1	6/2007	Kellogg et al.
2007/0020160	A1	1/2007	Berkman et al.	2007/0131168	A1	6/2007	Gomi et al.
2007/0020167	A1	1/2007	Han et al.	2007/0134821	A1	6/2007	Thakur et al.
2007/0020830	A1	1/2007	Speranza	2007/0134919	A1	6/2007	Gunji et al.
2007/0020953	A1	1/2007	Tsai et al.	2007/0134942	A1	6/2007	Ahn et al.
2007/0022954	A1	2/2007	Iizuka et al.	2007/0137794	A1	6/2007	Qiu et al.
2007/0026148	A1	2/2007	Arai et al.	2007/0144442	A1	6/2007	Migita
2007/0026162	A1	2/2007	Wei et al.	2007/0146621	A1	6/2007	Yeom
2007/0026540	A1	2/2007	Nooten et al.	2007/0148347	A1	6/2007	Hatanpaa et al.
2007/0028842	A1	2/2007	Inagawa et al.	2007/0148350	A1	6/2007	Rahtu
2007/0031598	A1	2/2007	Okuyama et al.	2007/0148990	A1	6/2007	Deboer et al.
2007/0031599	A1	2/2007	Gschwandtner et al.	2007/0153625	A1	6/2007	Lundgren et al.
2007/0032004	A1	2/2007	Ramaswamy et al.	2007/0155138	A1	7/2007	Tomasini et al.
2007/0032045	A1	2/2007	Kasahara et al.	2007/0157466	A1	7/2007	Kida et al.
2007/0032054	A1	2/2007	Ramaswamy et al.	2007/0157683	A1	7/2007	Li
2007/0032082	A1	2/2007	Ramaswamy et al.	2007/0158026	A1	7/2007	Amikura
2007/0032095	A1	2/2007	Ramaswamy et al.	2007/0163440	A1	7/2007	Kim et al.
2007/0034477	A1	2/2007	Inui	2007/0163625	A1	7/2007	Lee
2007/0037343	A1	2/2007	Colombo et al.	2007/0163996	A1	7/2007	Horiguchi
2007/0037412	A1	2/2007	Dip et al.	2007/0166457	A1	7/2007	Yamoto et al.
2007/0042117	A1	2/2007	Kupurao et al.	2007/0166966	A1	7/2007	Todd et al.
2007/0042581	A1	2/2007	Sano et al.	2007/0166999	A1	7/2007	Vaarstra
2007/0044716	A1	3/2007	Tetsuka et al.	2007/0170372	A1	7/2007	Horsky
2007/0045244	A1	3/2007	Lee et al.	2007/0173071	A1	7/2007	Afzali-Ardakani et al.
2007/0047384	A1	3/2007	McLaughlin et al.	2007/0175393	A1	8/2007	Nishimura et al.
2007/0048953	A1	3/2007	Gealy et al.	2007/0175397	A1	8/2007	Tomiyasu et al.
2007/0049053	A1	3/2007	Mahajani	2007/0178235	A1	8/2007	Yamada et al.
2007/0051299	A1	3/2007	Ong et al.	2007/0181066	A1	8/2007	Cadwell et al.
2007/0051312	A1	3/2007	Sneh	2007/0184179	A1	8/2007	Waghray et al.
2007/0051471	A1	3/2007	Kawaguchi et al.	2007/0186849	A1	8/2007	Furuya
2007/0054049	A1	3/2007	Lindfors et al.	2007/0186952	A1	8/2007	Honda et al.
2007/0054499	A1	3/2007	Jang	2007/0187362	A1	8/2007	Nakagawa et al.
2007/0056843	A1	3/2007	Ye et al.	2007/0187363	A1	8/2007	Oka et al.
				2007/0190266	A1	8/2007	Fu et al.
				2007/0190362	A1	8/2007	Weidman

(56)

References Cited

U.S. PATENT DOCUMENTS

2007/0190744	A1	8/2007	Hiraiwa et al.	2008/0035055	A1	2/2008	Dip et al.
2007/0190782	A1	8/2007	Park	2008/0035306	A1	2/2008	White et al.
2007/0199510	A1	8/2007	Weiner et al.	2008/0035607	A1	2/2008	O'Hara et al.
2007/0202678	A1	8/2007	Plombon et al.	2008/0036354	A1	2/2008	Letz et al.
2007/0205788	A1	9/2007	Natsuhara et al.	2008/0038485	A1	2/2008	Fukazawa et al.
2007/0207275	A1	9/2007	Nowak et al.	2008/0038934	A1	2/2008	Vrtis et al.
2007/0209588	A1	9/2007	Li et al.	2008/0042165	A1	2/2008	Sugizaki
2007/0209590	A1	9/2007	Li	2008/0042192	A1	2/2008	Park et al.
2007/0210890	A1	9/2007	Hsu et al.	2008/0043803	A1	2/2008	Bandoh
2007/0212484	A1	9/2007	Li	2008/0044938	A1	2/2008	England et al.
2007/0212811	A1	9/2007	Hanawa et al.	2008/0050536	A1	2/2008	Aing et al.
2007/0212827	A1	9/2007	Girotra et al.	2008/0050538	A1	2/2008	Hirata
2007/0215048	A1	9/2007	Suzuki et al.	2008/0054332	A1	3/2008	Kim et al.
2007/0215580	A1	9/2007	Koshiishi et al.	2008/0054813	A1	3/2008	Espiau et al.
2007/0218200	A1	9/2007	Suzuki et al.	2008/0056860	A1	3/2008	Natume
2007/0218705	A1	9/2007	Matsuki et al.	2008/0057659	A1	3/2008	Forbes et al.
2007/0222131	A1	9/2007	Fukumoto et al.	2008/0061667	A1	3/2008	Gaertner et al.
2007/0224777	A1	9/2007	Hamelin	2008/0063798	A1	3/2008	Kher et al.
2007/0224833	A1	9/2007	Morisada et al.	2008/0066778	A1	3/2008	Matsushita et al.
2007/0227665	A1	10/2007	Matsumoto et al.	2008/0067146	A1	3/2008	Onishi et al.
2007/0231488	A1	10/2007	Von Kaenel	2008/0069955	A1	3/2008	Hong et al.
2007/0232031	A1	10/2007	Singh et al.	2008/0072821	A1	3/2008	Dalton et al.
2007/0232071	A1	10/2007	Balseanu et al.	2008/0075562	A1	3/2008	Maria et al.
2007/0232501	A1	10/2007	Tonomura	2008/0075838	A1	3/2008	Inoue et al.
2007/0234955	A1	10/2007	Suzuki et al.	2008/0075881	A1	3/2008	Won et al.
2007/0237697	A1	10/2007	Clark	2008/0076070	A1	3/2008	Koh et al.
2007/0237698	A1	10/2007	Clark	2008/0076266	A1	3/2008	Fukazawa et al.
2007/0237699	A1	10/2007	Clark	2008/0076281	A1	3/2008	Ciancanelli et al.
2007/0238305	A1	10/2007	Delgadino et al.	2008/0081104	A1	4/2008	Hasebe et al.
2007/0241688	A1	10/2007	DeVancentis et al.	2008/0081113	A1	4/2008	Clark
2007/0243317	A1	10/2007	Du Bois et al.	2008/0081121	A1	4/2008	Morita et al.
2007/0247075	A1	10/2007	Kim et al.	2008/0083710	A1	4/2008	Chen et al.
2007/0248767	A1	10/2007	Okura	2008/0083948	A1	4/2008	Lin et al.
2007/0249131	A1	10/2007	Allen et al.	2008/0085226	A1	4/2008	Fondurulia et al.
2007/0251444	A1	11/2007	Gros-Jean et al.	2008/0085610	A1	4/2008	Wang et al.
2007/0251456	A1	11/2007	Herchen et al.	2008/0087218	A1	4/2008	Shimada et al.
2007/0252233	A1	11/2007	Yamazaki et al.	2008/0087642	A1	4/2008	Sawin et al.
2007/0252244	A1	11/2007	Srividya et al.	2008/0087890	A1	4/2008	Ahn et al.
2007/0252532	A1	11/2007	DeVancentis et al.	2008/0092815	A1	4/2008	Chen et al.
2007/0254414	A1	11/2007	Miyanami	2008/0092821	A1	4/2008	Otsuka et al.
2007/0258506	A1	11/2007	Schwagerman et al.	2008/0099147	A1*	5/2008	Myo C23C 16/45565 156/345.34
2007/0258855	A1	11/2007	Turcot et al.	2008/0102203	A1	5/2008	Wu
2007/0259778	A1	11/2007	Spencer et al.	2008/0102205	A1	5/2008	Barry et al.
2007/0261868	A1	11/2007	Gross	2008/0102208	A1	5/2008	Wu et al.
2007/0264427	A1	11/2007	Shinriki et al.	2008/0102603	A1	5/2008	Kobayashi et al.
2007/0264793	A1	11/2007	Oh et al.	2008/0102630	A1	5/2008	Saito
2007/0264807	A1	11/2007	Leone et al.	2008/0105276	A1	5/2008	Yeh et al.
2007/0266932	A1	11/2007	Hiramatsu	2008/0110401	A1	5/2008	Fujikawa et al.
2007/0266945	A1	11/2007	Shuto et al.	2008/0113094	A1	5/2008	Casper
2007/0269983	A1	11/2007	Sneh	2008/0113096	A1	5/2008	Mahajani
2007/0275166	A1	11/2007	Thridandam et al.	2008/0113097	A1	5/2008	Mahajani et al.
2007/0277735	A1	12/2007	Mokhesi et al.	2008/0118334	A1	5/2008	Bonora
2007/0281082	A1	12/2007	Mokhesi et al.	2008/0121177	A1	5/2008	Bang et al.
2007/0281105	A1	12/2007	Mokhesi et al.	2008/0121626	A1	5/2008	Thomas et al.
2007/0281106	A1	12/2007	Lubomirsky et al.	2008/0121962	A1	5/2008	Forbes et al.
2007/0281496	A1	12/2007	Ingle et al.	2008/0124197	A1	5/2008	van der Meulen et al.
2007/0286957	A1	12/2007	Suzuki et al.	2008/0124908	A1	5/2008	Forbes et al.
2007/0289534	A1	12/2007	Lubomirsky et al.	2008/0124945	A1	5/2008	Miya et al.
2007/0292974	A1	12/2007	Mizuno et al.	2008/0124946	A1	5/2008	Xiao et al.
2007/0295602	A1	12/2007	Tiller et al.	2008/0128726	A1	6/2008	Sakata et al.
2007/0298362	A1	12/2007	Rocha-Alvarez et al.	2008/0129209	A1	6/2008	Deakins et al.
2007/0298565	A1	12/2007	Nieh et al.	2008/0132046	A1	6/2008	Walther
2008/0003425	A1	1/2008	Spencer et al.	2008/0133154	A1	6/2008	Krauss et al.
2008/0003824	A1	1/2008	Padhi et al.	2008/0134887	A1	6/2008	Sherer
2008/0003838	A1	1/2008	Haukka et al.	2008/0142483	A1	6/2008	Hua
2008/0006208	A1	1/2008	Ueno et al.	2008/0146033	A1	6/2008	Park
2008/0018004	A1	1/2008	Steidl	2008/0149031	A1	6/2008	Chu et al.
2008/0020591	A1	1/2008	Balseanu et al.	2008/0149593	A1	6/2008	Bai et al.
2008/0020593	A1	1/2008	Wang et al.	2008/0152463	A1	6/2008	Chidambaram et al.
2008/0023436	A1	1/2008	Gros-Jean et al.	2008/0153308	A1	6/2008	Ogawa et al.
2008/0026162	A1	1/2008	Dickey et al.	2008/0153311	A1	6/2008	Padhi et al.
2008/0026574	A1	1/2008	Brcka	2008/0156769	A1	7/2008	Weiner et al.
2008/0026597	A1	1/2008	Munro et al.	2008/0157157	A1	7/2008	Tonomura
2008/0029790	A1	2/2008	Ahn et al.	2008/0157365	A1	7/2008	Ott et al.
2008/0031708	A1	2/2008	Bonora et al.	2008/0173237	A1	7/2008	Collins
				2008/0173238	A1	7/2008	Nakashima et al.
				2008/0173240	A1	7/2008	Furukawahara
				2008/0173326	A1	7/2008	Gu et al.

(56)

References Cited

U.S. PATENT DOCUMENTS

2008/0176335	A1	7/2008	Alberti et al.	2008/0305014	A1	12/2008	Honda
2008/0176375	A1	7/2008	Erben et al.	2008/0305246	A1	12/2008	Choi et al.
2008/0176412	A1	7/2008	Komeda	2008/0305443	A1	12/2008	Nakamura
2008/0178608	A1	7/2008	Tandon et al.	2008/0314319	A1	12/2008	Hamano et al.
2008/0178805	A1	7/2008	Paterson et al.	2008/0314892	A1	12/2008	Graham
2008/0179104	A1	7/2008	Zhang	2008/0315292	A1	12/2008	Ji et al.
2008/0179291	A1	7/2008	Collins et al.	2008/0317972	A1	12/2008	Hendriks
2008/0179715	A1	7/2008	Coppa	2009/0000550	A1	1/2009	Tran et al.
2008/0182075	A1	7/2008	Chopra	2009/0000551	A1	1/2009	Choi et al.
2008/0182390	A1	7/2008	Lemmi et al.	2009/0000769	A1	1/2009	Lin et al.
2008/0182411	A1	7/2008	Elers	2009/0004875	A1	1/2009	Shen et al.
2008/0191193	A1	8/2008	Li et al.	2009/0011145	A1	1/2009	Yun
2008/0193643	A1	8/2008	Dip	2009/0011150	A1	1/2009	Jeon et al.
2008/0194105	A1	8/2008	Dominguez et al.	2009/0011608	A1	1/2009	Nabatame
2008/0194113	A1	8/2008	Kim et al.	2009/0014879	A1	1/2009	Park et al.
2008/0194169	A1	8/2008	Sterling et al.	2009/0017227	A1	1/2009	Fu et al.
2008/0199977	A1	8/2008	Weigel et al.	2009/0017631	A1	1/2009	Bencher
2008/0202416	A1	8/2008	Provencher	2009/0017733	A1	1/2009	Takahashi et al.
2008/0202689	A1	8/2008	Kim	2009/0020072	A1	1/2009	Mizunaga et al.
2008/0203487	A1	8/2008	Hohage et al.	2009/0023229	A1	1/2009	Matsushita
2008/0205483	A1	8/2008	Rempe et al.	2009/0029503	A1	1/2009	Arai
2008/0210162	A1	9/2008	Yonebayashi	2009/0029528	A1	1/2009	Sanchez et al.
2008/0210278	A1	9/2008	Orii et al.	2009/0029564	A1	1/2009	Yamashita et al.
2008/0211423	A1	9/2008	Shinmen et al.	2009/0031954	A1	2/2009	Nishikido et al.
2008/0211526	A1	9/2008	Shinma	2009/0033907	A1	2/2009	Watson
2008/0213696	A1	9/2008	Meeus et al.	2009/0035463	A1	2/2009	Dip
2008/0214003	A1	9/2008	Xia et al.	2009/0035584	A1	2/2009	Tran et al.
2008/0216077	A1	9/2008	Emani et al.	2009/0035927	A1	2/2009	Olsen et al.
2008/0216742	A1	9/2008	Takebayashi	2009/0035947	A1	2/2009	Horii
2008/0216958	A1	9/2008	Goto et al.	2009/0036292	A1	2/2009	Sun et al.
2008/0220619	A1	9/2008	Matsushita et al.	2009/0039475	A1	2/2009	Shioya
2008/0223130	A1	9/2008	Snell et al.	2009/0041952	A1	2/2009	Yoon et al.
2008/0224240	A1	9/2008	Ahn et al.	2009/0041984	A1	2/2009	Mayers et al.
2008/0228306	A1	9/2008	Yetter et al.	2009/0042344	A1	2/2009	Ye et al.
2008/0229811	A1	9/2008	Zhao et al.	2009/0042408	A1	2/2009	Maeda
2008/0230371	A1	9/2008	McHugh	2009/0045749	A1	2/2009	Ganachev et al.
2008/0233288	A1	9/2008	Clark	2009/0045829	A1	2/2009	Awazu
2008/0237572	A1	10/2008	Chui et al.	2009/0047426	A1	2/2009	Park et al.
2008/0241052	A1	10/2008	Hooper et al.	2009/0047433	A1	2/2009	Kim et al.
2008/0241384	A1	10/2008	Jeong	2009/0047447	A1	2/2009	Sawin et al.
2008/0241387	A1	10/2008	Keto	2009/0050621	A1	2/2009	Awazu
2008/0242116	A1	10/2008	Clark	2009/0052498	A1	2/2009	Halpin et al.
2008/0248310	A1	10/2008	Kim et al.	2009/0053023	A1	2/2009	Wakabayashi
2008/0248597	A1	10/2008	Qin et al.	2009/0053900	A1	2/2009	Nozawa et al.
2008/0257102	A1	10/2008	Packer	2009/0053906	A1	2/2009	Miya et al.
2008/0257494	A1	10/2008	Hayashi et al.	2009/0056112	A1	3/2009	Kobayashi
2008/0260345	A1	10/2008	Mertesdorf et al.	2009/0056629	A1	3/2009	Katz et al.
2008/0260963	A1	10/2008	Yoon et al.	2009/0057269	A1	3/2009	Katz et al.
2008/0261405	A1	10/2008	Yang et al.	2009/0061083	A1	3/2009	Chiang et al.
2008/0261413	A1	10/2008	Mahajani	2009/0061644	A1	3/2009	Chiang et al.
2008/0264337	A1	10/2008	Sano et al.	2009/0061647	A1	3/2009	Mallick et al.
2008/0264443	A1	10/2008	Shrinivasan et al.	2009/0075490	A1	3/2009	Dussarrat
2008/0267598	A1	10/2008	Nakamura	2009/0075491	A1	3/2009	Liu et al.
2008/0268171	A1	10/2008	Ma et al.	2009/0081879	A1	3/2009	Sukekawa et al.
2008/0268635	A1	10/2008	Yu et al.	2009/0084317	A1	4/2009	Wu
2008/0272424	A1	11/2008	Kim et al.	2009/0085156	A1	4/2009	Dewey et al.
2008/0274369	A1	11/2008	Lee et al.	2009/0087585	A1	4/2009	Lee et al.
2008/0276864	A1	11/2008	Koelmel et al.	2009/0087964	A1	4/2009	Maeda et al.
2008/0277647	A1	11/2008	Kouvetakis et al.	2009/0087967	A1	4/2009	Todd
2008/0277656	A1	11/2008	Park et al.	2009/0090382	A1	4/2009	Morisada
2008/0277715	A1	11/2008	Ohmi et al.	2009/0093080	A1	4/2009	Choi et al.
2008/0282970	A1	11/2008	Heys et al.	2009/0093094	A1	4/2009	Ye et al.
2008/0283962	A1	11/2008	Dyer	2009/0093100	A1	4/2009	Xia et al.
2008/0286463	A1	11/2008	Tiner et al.	2009/0095221	A1	4/2009	Tam et al.
2008/0289574	A1	11/2008	Jacobs et al.	2009/0104351	A1	4/2009	Kakegawa
2008/0289650	A1	11/2008	Arena	2009/0104594	A1	4/2009	Webb
2008/0289767	A1	11/2008	Tandou et al.	2009/0104789	A1	4/2009	Mallick et al.
2008/0291964	A1	11/2008	Shrimpling	2009/0107404	A1	4/2009	Ogliari et al.
2008/0295872	A1*	12/2008	Riker H01J 37/32477 134/105	2009/0108308	A1	4/2009	Yang et al.
2008/0298945	A1	12/2008	Cox	2009/0112458	A1	4/2009	Nakai
2008/0299326	A1	12/2008	Fukazawa	2009/0115064	A1	5/2009	Sandhu et al.
2008/0299758	A1	12/2008	Harada et al.	2009/0116936	A1	5/2009	Marubayashi et al.
2008/0302303	A1	12/2008	Choi et al.	2009/0117717	A1	5/2009	Tomasini et al.
2008/0303744	A1	12/2008	Hirayama et al.	2009/0117746	A1	5/2009	Masuda
				2009/0120580	A1	5/2009	Kagoshima et al.
				2009/0122293	A1	5/2009	Shibazaki
				2009/0122458	A1	5/2009	Lischer et al.
				2009/0124131	A1	5/2009	Breunsbach et al.
				2009/0130331	A1	5/2009	Asai

(56)

References Cited

U.S. PATENT DOCUMENTS

2009/0130859	A1	5/2009	Itatani et al.	2009/0286402	A1	11/2009	Xia et al.
2009/0136665	A1	5/2009	Choi et al.	2009/0286405	A1	11/2009	Okesaku et al.
2009/0136668	A1	5/2009	Gregg et al.	2009/0289300	A1	11/2009	Sasaki et al.
2009/0136683	A1	5/2009	Fukasawa et al.	2009/0291208	A1	11/2009	Gordon et al.
2009/0137055	A1	5/2009	Bognar	2009/0297710	A1	12/2009	Lindfors
2009/0139657	A1	6/2009	Lee et al.	2009/0297731	A1	12/2009	Goundar
2009/0142905	A1	6/2009	Yamazaki	2009/0298257	A1	12/2009	Lee et al.
2009/0142933	A1	6/2009	Yajima et al.	2009/0302002	A1	12/2009	Collins et al.
2009/0142935	A1	6/2009	Fukazawa et al.	2009/0302434	A1	12/2009	Pallem et al.
2009/0146322	A1	6/2009	Weling et al.	2009/0304558	A1	12/2009	Patton
2009/0147819	A1	6/2009	Goodman et al.	2009/0308315	A1	12/2009	de Ridder
2009/0155488	A1	6/2009	Nakano et al.	2009/0308425	A1	12/2009	Yednak
2009/0156015	A1	6/2009	Park et al.	2009/0311857	A1	12/2009	Todd et al.
2009/0156017	A1	6/2009	Fukazawa et al.	2009/0314208	A1	12/2009	Zhou et al.
2009/0159000	A1	6/2009	Aggarwal et al.	2009/0315093	A1	12/2009	Li et al.
2009/0159002	A1	6/2009	Bera et al.	2009/0317214	A1	12/2009	Hsiao et al.
2009/0159424	A1	6/2009	Liu et al.	2009/0320754	A1	12/2009	Oya
2009/0162647	A1	6/2009	Sun et al.	2009/0320881	A1	12/2009	Aitchison
2009/0162996	A1	6/2009	Ramaswamy et al.	2009/0324971	A1	12/2009	De Vries et al.
2009/0163038	A1	6/2009	Miyoshi	2009/0324989	A1	12/2009	Witz et al.
2009/0165715	A1	7/2009	Oh	2009/0325391	A1	12/2009	De Vusser et al.
2009/0165721	A1	7/2009	Pitney et al.	2009/0325469	A1	12/2009	Koo et al.
2009/0165722	A1	7/2009	Ha	2010/0000608	A1	1/2010	Goto et al.
2009/0166616	A1	7/2009	Uchiyama	2010/0001409	A1	1/2010	Humbert et al.
2009/0179365	A1	7/2009	Lerner et al.	2010/0003406	A1	1/2010	Lam et al.
2009/0183520	A1	7/2009	Yukimoto	2010/0006031	A1	1/2010	Choi et al.
2009/0186479	A1	7/2009	Okabe et al.	2010/0006923	A1	1/2010	Fujitsuka
2009/0186571	A1	7/2009	Haro	2010/0012036	A1	1/2010	Silva et al.
2009/0194233	A1	8/2009	Tamura et al.	2010/0014479	A1	1/2010	Kim
2009/0197015	A1	8/2009	Kudela et al.	2010/0015813	A1	1/2010	McGinnis et al.
2009/0197411	A1	8/2009	Dussarrat et al.	2010/0018460	A1	1/2010	Singh et al.
2009/0200494	A1	8/2009	Hatem	2010/0018913	A1	1/2010	Blum
2009/0200547	A1	8/2009	Griffin et al.	2010/0022097	A1	1/2010	Yamoto et al.
2009/0204403	A1	8/2009	Hollander et al.	2010/0024727	A1	2/2010	Kim et al.
2009/0206056	A1	8/2009	Xu	2010/0024872	A1	2/2010	Kishimoto
2009/0209081	A1	8/2009	Matero	2010/0025766	A1	2/2010	Nuttinck et al.
2009/0211523	A1	8/2009	Kuppurao et al.	2010/0025796	A1	2/2010	Dabiran
2009/0211525	A1	8/2009	Sarigiannis et al.	2010/0031884	A1	2/2010	Aggarwal et al.
2009/0214825	A1	8/2009	Sun et al.	2010/0032587	A1	2/2010	Hosch et al.
2009/0217871	A1	9/2009	Kim et al.	2010/0032842	A1	2/2010	Herdt et al.
2009/0221149	A1	9/2009	Hammond et al.	2010/0034719	A1	2/2010	Dussarrat et al.
2009/0221151	A1	9/2009	Honda et al.	2010/0040441	A1	2/2010	Obikane
2009/0223441	A1	9/2009	Arena et al.	2010/0041179	A1	2/2010	Lee
2009/0227094	A1	9/2009	Bateman	2010/0041243	A1	2/2010	Cheng et al.
2009/0230211	A1	9/2009	Kobayashi et al.	2010/0046321	A1	2/2010	McLaughlin et al.
2009/0232985	A1	9/2009	Dussarrat et al.	2010/0050943	A1	3/2010	Kato et al.
2009/0236014	A1	9/2009	Wilson	2010/0051584	A1	3/2010	Okita et al.
2009/0236276	A1	9/2009	Kurth et al.	2010/0051597	A1	3/2010	Morita et al.
2009/0239386	A1	9/2009	Suzaki et al.	2010/0055312	A1	3/2010	Kato et al.
2009/0242130	A1	10/2009	Tian et al.	2010/0055316	A1	3/2010	Honma
2009/0242957	A1	10/2009	Ma et al.	2010/0055318	A1	3/2010	Volf et al.
2009/0246374	A1	10/2009	Vukovic	2010/0055442	A1	3/2010	Kellock
2009/0246399	A1	10/2009	Goundar	2010/0055898	A1	3/2010	Chang et al.
2009/0246971	A1	10/2009	Reid et al.	2010/0058984	A1	3/2010	Marubayashi
2009/0250004	A1	10/2009	Yamada et al.	2010/0065758	A1	3/2010	Liu et al.
2009/0250955	A1	10/2009	Aoki	2010/0068009	A1	3/2010	Kimura
2009/0255901	A1	10/2009	Okita	2010/0068383	A1	3/2010	Kato et al.
2009/0256127	A1	10/2009	Feist et al.	2010/0068414	A1	3/2010	Takahashi et al.
2009/0261331	A1	10/2009	Yang et al.	2010/0068891	A1	3/2010	Hatanaka et al.
2009/0266296	A1	10/2009	Tachibana et al.	2010/0075037	A1	3/2010	Marsh et al.
2009/0267135	A1	10/2009	Tanaka et al.	2010/0075488	A1	3/2010	Collins et al.
2009/0267225	A1	10/2009	Eguchi	2010/0075507	A1	3/2010	Chang et al.
2009/0269506	A1*	10/2009	Okura C23C 16/4405 427/534	2010/0078601	A1	4/2010	Pallem et al.
2009/0269507	A1	10/2009	Yu et al.	2010/0078746	A1	4/2010	Jung
2009/0269941	A1	10/2009	Raisanen	2010/0081094	A1	4/2010	Hasebe et al.
2009/0275205	A1	11/2009	Kiehlbauch et al.	2010/0081293	A1	4/2010	Mallick et al.
2009/0275210	A1	11/2009	Shanker et al.	2010/0086703	A1	4/2010	Mangum et al.
2009/0277510	A1	11/2009	Shikata	2010/0087069	A1	4/2010	Miya et al.
2009/0277874	A1	11/2009	Rui et al.	2010/0089320	A1	4/2010	Kim
2009/0280248	A1	11/2009	Goodman et al.	2010/0089870	A1	4/2010	Hiroshima et al.
2009/0283041	A1	11/2009	Tomiyasu et al.	2010/0090149	A1	4/2010	Thompson et al.
2009/0283217	A1	11/2009	Lubomirsky et al.	2010/0092679	A1	4/2010	Lee et al.
2009/0284156	A1	11/2009	Banna et al.	2010/0092696	A1	4/2010	Shinriki
2009/0286400	A1	11/2009	Heo et al.	2010/0093187	A1	4/2010	Lee et al.
				2010/0094430	A1	4/2010	Krumdieck
				2010/0098862	A1	4/2010	Xu et al.
				2010/0101728	A1	4/2010	Iwasaki
				2010/0102417	A1	4/2010	Ganguli et al.
				2010/0105936	A1	4/2010	Tada et al.

(56)

References Cited

U.S. PATENT DOCUMENTS

2010/0111648 A1	5/2010	Tamura et al.	2010/0255198 A1	10/2010	Cleary et al.
2010/0112496 A1	5/2010	Nakajima et al.	2010/0255218 A1	10/2010	Oka et al.
2010/0116207 A1	5/2010	Givens	2010/0255625 A1	10/2010	De Vries
2010/0116208 A1	5/2010	Sangam	2010/0255658 A1	10/2010	Aggarwal
2010/0116209 A1	5/2010	Kato	2010/0259152 A1	10/2010	Yasuda et al.
2010/0119439 A1	5/2010	Shindou	2010/0266765 A1	10/2010	White et al.
2010/0119727 A1	5/2010	Takagi	2010/0267224 A1	10/2010	Choi et al.
2010/0120261 A1	5/2010	Kim et al.	2010/0267248 A1	10/2010	Ma
2010/0124610 A1	5/2010	Aikawa et al.	2010/0270675 A1	10/2010	Harada
2010/0124618 A1	5/2010	Kobayashi et al.	2010/0246630 A1	11/2010	Kaszynski et al.
2010/0124621 A1	5/2010	Kobayashi et al.	2010/0275846 A1	11/2010	Kitagawa
2010/0126415 A1	5/2010	Ishino et al.	2010/0279008 A1	11/2010	Takagi
2010/0126539 A1	5/2010	Lee et al.	2010/0279512 A1	11/2010	Udea et al.
2010/0126605 A1	5/2010	Stones	2010/0282163 A1	11/2010	Aggarwal et al.
2010/0126666 A1	5/2010	Tandou et al.	2010/0282170 A1	11/2010	Nishizawa
2010/0129548 A1	5/2010	Sneh	2010/0282645 A1	11/2010	Wang
2010/0129990 A1	5/2010	Nishizawa et al.	2010/0285237 A1	11/2010	Ditizio et al.
2010/0130015 A1	5/2010	Nakajima et al.	2010/0285319 A1	11/2010	Kwak et al.
2010/0130017 A1	5/2010	Luo et al.	2010/0294199 A1*	11/2010	Tran C23C 16/4401
2010/0130105 A1	5/2010	Lee			118/723 R
2010/0133255 A1	6/2010	Bahng et al.	2010/0297391 A1	11/2010	Kley
2010/0134023 A1	6/2010	Mills	2010/0301752 A1	12/2010	Bakre et al.
2010/0136216 A1	6/2010	Tsuei et al.	2010/0304047 A1	12/2010	Yang et al.
2010/0140221 A1	6/2010	Kikuchi et al.	2010/0307415 A1	12/2010	Shero et al.
2010/0140684 A1	6/2010	Ozawa	2010/0317177 A1	12/2010	Huang et al.
2010/0143609 A1	6/2010	Fukazawa et al.	2010/0317198 A1	12/2010	Antonelli
2010/0144150 A1	6/2010	Sills et al.	2010/0322604 A1	12/2010	Fondurulia et al.
2010/0144162 A1	6/2010	Lee et al.	2010/0326358 A1	12/2010	Choi
2010/0144968 A1	6/2010	Lee et al.	2011/0000619 A1	1/2011	Suh
2010/0145547 A1	6/2010	Darabnia et al.	2011/0003087 A1	1/2011	Soininen et al.
2010/0147396 A1	6/2010	Yamagishi et al.	2011/0003450 A1	1/2011	Lee et al.
2010/0151206 A1	6/2010	Wu et al.	2011/0005684 A1	1/2011	Hayami et al.
2010/0159638 A1	6/2010	Jeong	2011/0006402 A1	1/2011	Zhou
2010/0159707 A1	6/2010	Huang et al.	2011/0006406 A1	1/2011	Urbanowicz et al.
2010/0162752 A1	7/2010	Tabata et al.	2011/0008950 A1	1/2011	Xu
2010/0162956 A1	7/2010	Murakami et al.	2011/0014359 A1	1/2011	Hashim
2010/0163524 A1	7/2010	Arai	2011/0014795 A1	1/2011	Lee
2010/0163937 A1	7/2010	Clendenning	2011/0017139 A1	1/2011	Chiang et al.
2010/0166630 A1	7/2010	Gu et al.	2011/0021033 A1	1/2011	Ikeuchi et al.
2010/0168404 A1	7/2010	Girolami et al.	2011/0027725 A1	2/2011	Tsutsumi et al.
2010/0170441 A1	7/2010	Won et al.	2011/0027999 A1	2/2011	Sparks et al.
2010/0170868 A1	7/2010	Lin et al.	2011/0031562 A1	2/2011	Lin et al.
2010/0173432 A1	7/2010	White et al.	2011/0034039 A1	2/2011	Liang et al.
2010/0178137 A1	7/2010	Chintalapati et al.	2011/0039419 A1	2/2011	Date et al.
2010/0178423 A1	7/2010	Shimizu et al.	2011/0041764 A1	2/2011	Webb et al.
2010/0180819 A1	7/2010	Hatanaka et al.	2011/0042200 A1	2/2011	Wilby
2010/0183825 A1	7/2010	Becker et al.	2011/0045610 A1	2/2011	van Schravendijk
2010/0184302 A1	7/2010	Lee et al.	2011/0045676 A1	2/2011	Park et al.
2010/0186669 A1	7/2010	Shin et al.	2011/0046314 A1	2/2011	Klipp et al.
2010/0189923 A1	7/2010	Goundar et al.	2011/0048642 A1	3/2011	Mihara et al.
2010/0193501 A1	8/2010	Zucker et al.	2011/0048769 A1	3/2011	Fujiwara
2010/0193955 A1	8/2010	Milligan et al.	2011/0049100 A1	3/2011	Han et al.
2010/0195392 A1	8/2010	Freeman	2011/0052833 A1	3/2011	Hanawa et al.
2010/0197107 A1	8/2010	Matsuzaki	2011/0053383 A1	3/2011	Shero et al.
2010/0202860 A1	8/2010	Reed	2011/0056513 A1	3/2011	Hornbach et al.
2010/0203242 A1	8/2010	Borden	2011/0056626 A1	3/2011	Brown et al.
2010/0206767 A1	8/2010	Odashima et al.	2011/0057248 A1	3/2011	Ma et al.
2010/0209598 A1	8/2010	Xu et al.	2011/0061810 A1*	3/2011	Ganguly H01L 21/67207
2010/0210108 A1	8/2010	Ishizaka et al.			156/345.27
2010/0219757 A1	9/2010	Benzerrouk et al.	2011/0065289 A1	3/2011	Asai
2010/0221452 A1	9/2010	Kang	2011/0067522 A1	3/2011	Lai
2010/0224130 A1	9/2010	Smith et al.	2011/0070380 A1	3/2011	Shero et al.
2010/0227458 A1	9/2010	Chung et al.	2011/0070740 A1	3/2011	Bettencourt et al.
2010/0229795 A1	9/2010	Tanabe	2011/0076401 A1	3/2011	Chao et al.
2010/0229965 A1	9/2010	Kashima et al.	2011/0081519 A1	4/2011	Dillingh
2010/0230051 A1	9/2010	Iizuka	2011/0083496 A1	4/2011	Lin et al.
2010/0230863 A1	9/2010	Moench et al.	2011/0086516 A1	4/2011	Lee et al.
2010/0233885 A1	9/2010	Kushibiki et al.	2011/0089166 A1	4/2011	Hunter et al.
2010/0233886 A1	9/2010	Yang et al.	2011/0089469 A1	4/2011	Merckling
2010/0236691 A1	9/2010	Yamazaki	2011/0092077 A1	4/2011	Xu et al.
2010/0243166 A1	9/2010	Hayashi et al.	2011/0097901 A1	4/2011	Banna et al.
2010/0244688 A1	9/2010	Braun et al.	2011/0098841 A1	4/2011	Tsuda
2010/0248465 A1	9/2010	Yi et al.	2011/0100489 A1	5/2011	Orito et al.
2010/0252434 A1	10/2010	Roy	2011/0104395 A1	5/2011	Kumagai et al.
2010/0255196 A1	10/2010	Geisler et al.	2011/0107512 A1	5/2011	Gilbert
			2011/0108194 A1	5/2011	Yoshioka et al.
			2011/0108424 A1	5/2011	Puget et al.
			2011/0108741 A1	5/2011	Ingram
			2011/0108929 A1	5/2011	Meng

(56)

References Cited

U.S. PATENT DOCUMENTS

2011/0114261 A1	5/2011	Matsumoto et al.	2011/0269314 A1	11/2011	Lee et al.
2011/0114601 A1	5/2011	Lubomirsky et al.	2011/0275018 A1	11/2011	Matteo et al.
2011/0115378 A1	5/2011	Lubomirsky et al.	2011/0275166 A1	11/2011	Shero et al.
2011/0117490 A1	5/2011	Bae et al.	2011/0277690 A1	11/2011	Rozenzon et al.
2011/0117492 A1	5/2011	Yamada et al.	2011/0281417 A1	11/2011	Gordon et al.
2011/0117732 A1	5/2011	Bauer et al.	2011/0283933 A1	11/2011	Makarov et al.
2011/0117737 A1	5/2011	Agarwala et al.	2011/0286819 A1	11/2011	Shibata et al.
2011/0117749 A1	5/2011	Shen	2011/0291243 A1	12/2011	Seamons
2011/0121503 A1*	5/2011	Burrows H01L 21/67115 269/289 R	2011/0294075 A1	12/2011	Chen et al.
			2011/0294288 A1	12/2011	Lee et al.
			2011/0297088 A1	12/2011	Song et al.
			2011/0298062 A1	12/2011	Ganguli et al.
			2011/0300720 A1	12/2011	Fu
			2011/0305102 A1	12/2011	Berger et al.
2011/0121736 A1	5/2011	Hirayama et al.	2011/0308453 A1	12/2011	Su et al.
2011/0124196 A1	5/2011	Lee	2011/0308460 A1	12/2011	Hong et al.
2011/0127702 A1	6/2011	Gautam et al.	2011/0312191 A1	12/2011	Ohkura et al.
2011/0132542 A1	6/2011	Ilzuka	2011/0318142 A1	12/2011	Gage et al.
2011/0135842 A1	6/2011	Faguet et al.	2011/0318888 A1	12/2011	Komatsu et al.
2011/0139272 A1	6/2011	Matsumoto et al.	2011/0318935 A1	12/2011	Oyabu et al.
2011/0139748 A1	6/2011	Donnelly et al.	2012/0001172 A1	1/2012	Shang et al.
2011/0140172 A1	6/2011	Chu	2012/0003500 A1	1/2012	Yoshida et al.
2011/0140173 A1	6/2011	Ramdani	2012/0003599 A1	1/2012	Patalay et al.
2011/0143032 A1	6/2011	Vrtis et al.	2012/0003726 A1	1/2012	Jones et al.
2011/0143461 A1	6/2011	Fish et al.	2012/0003831 A1	1/2012	Kang et al.
2011/0155264 A1	6/2011	Minami et al.	2012/0006489 A1	1/2012	Okita
2011/0155322 A1	6/2011	Himori et al.	2012/0009802 A1	1/2012	Lavoie
2011/0159200 A1	6/2011	Kogure	2012/0012556 A1	1/2012	Matsumoto et al.
2011/0159202 A1	6/2011	Matsushita	2012/0021252 A1	1/2012	Lee
2011/0159673 A1	6/2011	Hanawa et al.	2012/0024223 A1	2/2012	Torres et al.
2011/0159680 A1	6/2011	Yoo	2012/0024227 A1	2/2012	Takasuka et al.
2011/0168330 A1	7/2011	Sakaue et al.	2012/0024231 A1	2/2012	Horino
2011/0171380 A1	7/2011	Higashi et al.	2012/0024478 A1	2/2012	Huang et al.
2011/0171775 A1	7/2011	Yamamoto et al.	2012/0024479 A1	2/2012	Palagashvili et al.
2011/0175011 A1	7/2011	Ehrne et al.	2012/0027547 A1	2/2012	Jager et al.
2011/0177648 A1	7/2011	Tanner et al.	2012/0028454 A1	2/2012	Swaminathan et al.
2011/0180233 A1	7/2011	Bera et al.	2012/0028469 A1	2/2012	Onizawa et al.
2011/0183079 A1	7/2011	Jackson et al.	2012/0031333 A1	2/2012	Kurita et al.
2011/0183269 A1	7/2011	Zhu	2012/0031500 A1	2/2012	Hirose et al.
2011/0183527 A1	7/2011	Cho	2012/0032311 A1	2/2012	Gates
2011/0185969 A1	8/2011	Yang	2012/0033695 A1	2/2012	Hayashi et al.
2011/0192820 A1	8/2011	Yeom et al.	2012/0034793 A1	2/2012	Narushima et al.
2011/0195574 A1	8/2011	Blasco et al.	2012/0036732 A1	2/2012	Varadarajan
2011/0198034 A1	8/2011	Sun et al.	2012/0040097 A1	2/2012	Volf et al.
2011/0198417 A1	8/2011	Detmar et al.	2012/0040528 A1	2/2012	Kim et al.
2011/0198736 A1	8/2011	Shero et al.	2012/0043556 A1	2/2012	Dube et al.
2011/0204025 A1	8/2011	Tahara	2012/0043617 A1	2/2012	Nakagawa et al.
2011/0207332 A1	8/2011	Liu et al.	2012/0046421 A1	2/2012	Darling et al.
2011/0210468 A1	9/2011	Shannon et al.	2012/0052681 A1	3/2012	Marsh
2011/0217838 A1	9/2011	Hsieh et al.	2012/0058270 A1	3/2012	Winter et al.
2011/0220874 A1	9/2011	Hanrath	2012/0058630 A1	3/2012	Quinn
2011/0223334 A1	9/2011	Yudovsky et al.	2012/0064690 A1	3/2012	Hirota et al.
2011/0226421 A1	9/2011	Hayashi	2012/0064726 A1	3/2012	Nozawa et al.
2011/0232678 A1	9/2011	Shih et al.	2012/0064764 A1*	3/2012	Islam H01R 24/40 439/578
2011/0236201 A1	9/2011	Shende			
2011/0236594 A1	9/2011	Haverkamp et al.	2012/0068242 A1	3/2012	Shin et al.
2011/0236600 A1	9/2011	Fox et al.	2012/0070136 A1	3/2012	Koelmel et al.
2011/0237040 A1	9/2011	Ng et al.	2012/0070997 A1	3/2012	Larson
2011/0239936 A1	10/2011	Suzaki et al.	2012/0073400 A1	3/2012	Wang
2011/0239940 A1	10/2011	Benvenuti et al.	2012/0074533 A1	3/2012	Aoyama
2011/0244673 A1	10/2011	Cho et al.	2012/0077349 A1	3/2012	Li et al.
2011/0253044 A1	10/2011	Tam et al.	2012/0080756 A1	4/2012	Suzuki
2011/0254052 A1	10/2011	Kouvetakis	2012/0083134 A1	4/2012	Wu et al.
2011/0256675 A1	10/2011	Avouris	2012/0088031 A1	4/2012	Neel
2011/0256692 A1	10/2011	Tam et al.	2012/0090704 A1	4/2012	Laverdiere et al.
2011/0256724 A1	10/2011	Chandrasekharan et al.	2012/0091522 A1	4/2012	Ozaki et al.
2011/0256726 A1	10/2011	Lavoie et al.	2012/0094468 A1	4/2012	Bhatia et al.
2011/0256727 A1	10/2011	Beynet et al.	2012/0098107 A1	4/2012	Raisanen et al.
2011/0256734 A1	10/2011	Hausmann et al.	2012/0100464 A1	4/2012	Kageyama
2011/0259519 A1	10/2011	Kenworthy et al.	2012/0103264 A1	5/2012	Choi et al.
2011/0262642 A1	10/2011	Xiao et al.	2012/0103522 A1	5/2012	Hohenwarter
2011/0263107 A1	10/2011	Chung et al.	2012/0103939 A1	5/2012	Wu et al.
2011/0263115 A1	10/2011	Ganguli et al.	2012/0104514 A1	5/2012	Park et al.
2011/0264250 A1	10/2011	Nishimura et al.	2012/0107607 A1	5/2012	Takaki et al.
2011/0265549 A1	11/2011	Cruse et al.	2012/0108039 A1	5/2012	Zajaji
2011/0265715 A1	11/2011	Keller	2012/0108048 A1	5/2012	Lim et al.
2011/0265725 A1	11/2011	Tsuji	2012/0114877 A1	5/2012	Lee
2011/0265951 A1	11/2011	Xu et al.	2012/0115250 A1	5/2012	Ariga et al.
2011/0266611 A1	11/2011	Kim et al.	2012/0115257 A1	5/2012	Matsuyam et al.

(56)

References Cited

U.S. PATENT DOCUMENTS

2012/0119337 A1	5/2012	Sasaki et al.	2012/0270393 A1	10/2012	Pore et al.
2012/0121823 A1	5/2012	Chhabra	2012/0273052 A1	11/2012	Ye et al.
2012/0122275 A1	5/2012	Koo et al.	2012/0273162 A1	11/2012	Mahadeswaraswamy
2012/0122302 A1	5/2012	Weisman et al.	2012/0276306 A1	11/2012	Ueda
2012/0122319 A1	5/2012	Shimizu	2012/0288625 A1	11/2012	Furuya et al.
2012/0125258 A1	5/2012	Lee	2012/0289053 A1	11/2012	Holland et al.
2012/0126300 A1	5/2012	Park et al.	2012/0289056 A1	11/2012	Bergman et al.
2012/0128897 A1	5/2012	Xiao et al.	2012/0289057 A1	11/2012	DeDontney
2012/0135145 A1	5/2012	Je et al.	2012/0295427 A1	11/2012	Bauer
2012/0139009 A1	6/2012	Ning et al.	2012/0295449 A1	11/2012	Fukazawa
2012/0145078 A1	6/2012	Huang et al.	2012/0302055 A1	11/2012	Pore et al.
2012/0146113 A1	6/2012	Suzuki et al.	2012/0303313 A1	11/2012	Moroi et al.
2012/0149207 A1	6/2012	Graff	2012/0304935 A1	12/2012	Oosterlaken et al.
2012/0149213 A1	6/2012	Nittala	2012/0305026 A1	12/2012	Nomura et al.
2012/0156108 A1	6/2012	Fondurulia et al.	2012/0305196 A1	12/2012	Mori et al.
2012/0156890 A1	6/2012	Yim et al.	2012/0305987 A1	12/2012	Hirler et al.
2012/0160172 A1	6/2012	Wamura et al.	2012/0307588 A1	12/2012	Hanada et al.
2012/0160809 A1	6/2012	Ishibashi et al.	2012/0309181 A1	12/2012	Machkaoutsan et al.
2012/0161126 A1	6/2012	Yamazaki	2012/0310440 A1	12/2012	Darabnia et al.
2012/0161405 A1	6/2012	Mohn	2012/0315113 A1	12/2012	Hiroki
2012/0164327 A1	6/2012	Sato	2012/0315404 A1	12/2012	Li et al.
2012/0164837 A1	6/2012	Tan et al.	2012/0318334 A1	12/2012	Bedell et al.
2012/0164842 A1	6/2012	Watanabe	2012/0318457 A1	12/2012	Nguyen et al.
2012/0164846 A1	6/2012	Ha et al.	2012/0318773 A1	12/2012	Wu et al.
2012/0170170 A1	7/2012	Gros-Jean	2012/0319279 A1	12/2012	Isobayashi
2012/0171391 A1	7/2012	Won	2012/0320491 A1	12/2012	Doh et al.
2012/0171874 A1	7/2012	Thridandam et al.	2012/0321786 A1	12/2012	Satitpunwaycha et al.
2012/0175518 A1	7/2012	Godet et al.	2012/0322252 A1	12/2012	Son et al.
2012/0175751 A1	7/2012	Gatineau et al.	2012/0325148 A1	12/2012	Yamagishi et al.
2012/0177845 A1	7/2012	Odedra et al.	2012/0328780 A1	12/2012	Yamagishi et al.
2012/0180719 A1	7/2012	Inoue et al.	2013/0002121 A1	1/2013	Ma
2012/0180954 A1	7/2012	Yang et al.	2013/0005122 A1	1/2013	Schwarzenbach et al.
2012/0183689 A1	7/2012	Suzuki et al.	2013/0005147 A1	1/2013	Angyal et al.
2012/0186521 A1	7/2012	Iwasaki et al.	2013/0008607 A1	1/2013	Matsumoto et al.
2012/0186573 A1	7/2012	Jdira et al.	2013/0011983 A1	1/2013	Tsai
2012/0187083 A1	7/2012	Hashizume	2013/0011984 A1	1/2013	Wang et al.
2012/0187305 A1	7/2012	Elam et al.	2013/0012034 A1	1/2013	Ahn et al.
2012/0190178 A1	7/2012	Wang et al.	2013/0014697 A1	1/2013	Kanayama
2012/0190185 A1	7/2012	Rogers	2013/0014896 A1	1/2013	Shoji et al.
2012/0190208 A1	7/2012	Ozu et al.	2013/0017503 A1	1/2013	de Ridder et al.
2012/0196048 A1	8/2012	Ueda	2013/0019944 A1	1/2013	Hekmatshoar-Tabai et al.
2012/0196242 A1	8/2012	Volfovski et al.	2013/0019945 A1	1/2013	Hekmatshoar-Tabai et al.
2012/0196450 A1	8/2012	Balseanu et al.	2013/0019960 A1	1/2013	Choi et al.
2012/0202358 A1	8/2012	Gealy et al.	2013/0020246 A1	1/2013	Hoots et al.
2012/0206033 A1	8/2012	Matsuyama	2013/0023120 A1	1/2013	Yaehashi et al.
2012/0207456 A1	8/2012	Kim et al.	2013/0023124 A1	1/2013	Nemani et al.
2012/0212121 A1	8/2012	Lin	2013/0023129 A1	1/2013	Reed
2012/0213947 A1	8/2012	Lee	2013/0025538 A1	1/2013	Collins et al.
2012/0214318 A1	8/2012	Fukazawa et al.	2013/0025786 A1	1/2013	Davidkovich et al.
2012/0216743 A1	8/2012	Itoh et al.	2013/0026451 A1	1/2013	Bangsaruntip et al.
2012/0219735 A1	8/2012	Bakker et al.	2013/0032085 A1	2/2013	Hanawa et al.
2012/0219824 A1	8/2012	Prolier	2013/0037532 A1	2/2013	Volfovski et al.
2012/0220139 A1	8/2012	Lee et al.	2013/0037858 A1	2/2013	Hong et al.
2012/0222813 A1	9/2012	Pal et al.	2013/0037886 A1	2/2013	Tsai et al.
2012/0222815 A1	9/2012	Sabri et al.	2013/0040447 A1	2/2013	Swaminathan et al.
2012/0225192 A1	9/2012	Yudovsky et al.	2013/0040481 A1	2/2013	Valley et al.
2012/0225561 A1	9/2012	Watanabe	2013/0042811 A1	2/2013	Shanker et al.
2012/0231771 A1	9/2012	Marcus	2013/0048606 A1	2/2013	Mao et al.
2012/0232340 A1	9/2012	Levy et al.	2013/0052585 A1	2/2013	Ayothi et al.
2012/0238074 A1	9/2012	Santhanam et al.	2013/0052836 A1	2/2013	Hirose et al.
2012/0240858 A1	9/2012	Taniyama et al.	2013/0059078 A1	3/2013	Gatineau et al.
2012/0241089 A1	9/2012	Dielmann et al.	2013/0061755 A1	3/2013	Frederick
2012/0241411 A1	9/2012	Darling et al.	2013/0062753 A1	3/2013	Nguyen et al.
2012/0244703 A1	9/2012	Nakayama et al.	2013/0062839 A1	3/2013	Tschinderle et al.
2012/0247386 A1	10/2012	Sanchez et al.	2013/0064973 A1	3/2013	Chen et al.
2012/0252229 A1	10/2012	Timans et al.	2013/0065189 A1	3/2013	Yoshii et al.
2012/0258257 A1	10/2012	Nguyen et al.	2013/0068391 A1	3/2013	Mazzocco et al.
2012/0263876 A1	10/2012	Haukka et al.	2013/0068727 A1	3/2013	Okita
2012/0263887 A1	10/2012	Papasouliotis et al.	2013/0068970 A1	3/2013	Matsushita
2012/0264051 A1	10/2012	Angelov et al.	2013/0069052 A1	3/2013	Sandhu
2012/0264305 A1	10/2012	Nakano	2013/0070456 A1	3/2013	Jang et al.
2012/0267048 A1	10/2012	Moyama et al.	2013/0075746 A1	3/2013	Mallikarjunaswamy et al.
2012/0269967 A1	10/2012	Yudovsky et al.	2013/0078376 A1	3/2013	Higashino et al.
2012/0270339 A1	10/2012	Xie et al.	2013/0078392 A1	3/2013	Xiao et al.
2012/0270384 A1	10/2012	Sanchez et al.	2013/0081702 A1	4/2013	Mohammed et al.
			2013/0082274 A1	4/2013	Yang
			2013/0084156 A1	4/2013	Shimamoto
			2013/0084408 A1	4/2013	Nakao et al.
			2013/0084711 A1	4/2013	Liang et al.

(56)

References Cited

U.S. PATENT DOCUMENTS

2013/0084714	A1	4/2013	Oka et al.	2013/0256265	A1	10/2013	Darling et al.
2013/0085618	A1	4/2013	Ding	2013/0256838	A1	10/2013	Sanchez et al.
2013/0089667	A1	4/2013	Lai et al.	2013/0256962	A1	10/2013	Ranish
2013/0089716	A1	4/2013	Krishnamurthy et al.	2013/0260371	A1	10/2013	Holt
2013/0089988	A1	4/2013	Wang et al.	2013/0264659	A1	10/2013	Jung
2013/0092085	A1	4/2013	Lee	2013/0267045	A1	10/2013	Lee et al.
2013/0093048	A1	4/2013	Chang et al.	2013/0269609	A1*	10/2013	Leeser H01L 21/67703
2013/0093321	A1	4/2013	Yoshikawa et al.				118/719
2013/0095664	A1	4/2013	Matero et al.	2013/0269612	A1	10/2013	Cheng et al.
2013/0095973	A1	4/2013	Kroneberger et al.	2013/0270676	A1	10/2013	Lindert et al.
2013/0099318	A1	4/2013	Adam et al.	2013/0276978	A1	10/2013	Bluck et al.
2013/0104988	A1	5/2013	Yednak et al.	2013/0280891	A1	10/2013	Kim et al.
2013/0104992	A1	5/2013	Yednak et al.	2013/0285155	A1	10/2013	Glass
2013/0107415	A1	5/2013	Banna et al.	2013/0287526	A1	10/2013	Bluck et al.
2013/0109172	A1	5/2013	Collins et al.	2013/0288427	A1	10/2013	Hung et al.
2013/0109192	A1	5/2013	Hawkins et al.	2013/0288471	A1	10/2013	Chi
2013/0112251	A1	5/2013	Hang et al.	2013/0288480	A1	10/2013	Sanchez et al.
2013/0113085	A1	5/2013	Michaelson et al.	2013/0288485	A1	10/2013	Liang et al.
2013/0115383	A1	5/2013	Lu et al.	2013/0292047	A1	11/2013	Tian et al.
2013/0115763	A1	5/2013	Takamure et al.	2013/0292676	A1	11/2013	Milligan et al.
2013/0115768	A1	5/2013	Pore et al.	2013/0292807	A1	11/2013	Raisanen et al.
2013/0118405	A1	5/2013	Ho et al.	2013/0295779	A1	11/2013	Chandra et al.
2013/0118895	A1	5/2013	Roozeboom et al.	2013/0299944	A1	11/2013	Lai et al.
2013/0119018	A1	5/2013	Kanarik et al.	2013/0302520	A1	11/2013	Wang et al.
2013/0122712	A1	5/2013	Kim et al.	2013/0302999	A1	11/2013	Won et al.
2013/0122722	A1	5/2013	Cissell et al.	2013/0303803	A1	11/2013	Doerr et al.
2013/0126515	A1	5/2013	Shero et al.	2013/0309876	A1	11/2013	Ogawa
2013/0129577	A1*	5/2013	Halpin B01J 8/0035	2013/0312663	A1	11/2013	Khosla et al.
			422/236	2013/0313656	A1	11/2013	Tong
2013/0130490	A1	5/2013	Lee et al.	2013/0319290	A1	12/2013	Xiao et al.
2013/0134148	A1	5/2013	Tachikawa	2013/0320429	A1	12/2013	Thomas
2013/0137279	A1	5/2013	Yamamoto et al.	2013/0323435	A1	12/2013	Xiao et al.
2013/0143401	A1	6/2013	Yu et al.	2013/0323859	A1	12/2013	Chen et al.
2013/0143415	A1	6/2013	Yudovsky et al.	2013/0323935	A1	12/2013	Suzuki et al.
2013/0145587	A1	6/2013	Adhiprakasha	2013/0330165	A1	12/2013	Wimplinger
2013/0145984	A1	6/2013	Zhang et al.	2013/0330911	A1	12/2013	Huang et al.
2013/0149874	A1	6/2013	Hirose et al.	2013/0330933	A1	12/2013	Fukazawa et al.
2013/0152933	A1	6/2013	Lischer et al.	2013/0333619	A1	12/2013	Omari
2013/0157409	A1	6/2013	Vaidya	2013/0337172	A1	12/2013	Lee
2013/0157521	A1	6/2013	Aldrich et al.	2013/0337583	A1	12/2013	Kobayashi et al.
2013/0160709	A1	6/2013	White et al.	2013/0337639	A1	12/2013	Ivanstov et al.
2013/0161629	A1	6/2013	Han et al.	2013/0337653	A1	12/2013	Kovalgin et al.
2013/0164458	A1	6/2013	Soininen et al.	2013/0340619	A1	12/2013	Tammera
2013/0168353	A1	7/2013	Okita et al.	2013/0340678	A1	12/2013	Wamura et al.
2013/0168354	A1	7/2013	Kanarik	2013/0344248	A1	12/2013	Clark
2013/0171818	A1	7/2013	Kim et al.	2014/0000843	A1	1/2014	Dunn et al.
2013/0175596	A1	7/2013	Cheng et al.	2014/0001520	A1	1/2014	Glass
2013/0177706	A1	7/2013	Baluja et al.	2014/0004274	A1	1/2014	Thompson
2013/0180448	A1	7/2013	Sakaue et al.	2014/0007808	A1	1/2014	Okabe et al.
2013/0183814	A1	7/2013	Huang et al.	2014/0014642	A1	1/2014	Elliot et al.
2013/0186340	A1	7/2013	Omori et al.	2014/0014644	A1	1/2014	Akiba et al.
2013/0189635	A1	7/2013	Lim et al.	2014/0015108	A1	1/2014	Kim et al.
2013/0189854	A1	7/2013	Hausmann et al.	2014/0015186	A1	1/2014	Wessel et al.
2013/0196502	A1	8/2013	Haukka et al.	2014/0017408	A1	1/2014	Gandikota et al.
2013/0196507	A1	8/2013	Ma et al.	2014/0017414	A1	1/2014	Fukazawa et al.
2013/0200518	A1	8/2013	Ahmed et al.	2014/0017908	A1	1/2014	Beynet et al.
2013/0202387	A1	8/2013	Hiroki	2014/0020619	A1	1/2014	Vincent et al.
2013/0203266	A1	8/2013	Hintze	2014/0020764	A1	1/2014	Woelk et al.
2013/0203267	A1	8/2013	Pomarede et al.	2014/0020839	A1	1/2014	Kenney et al.
2013/0206066	A1	8/2013	Han et al.	2014/0023794	A1	1/2014	Mahajani et al.
2013/0209940	A1	8/2013	Sakamoto et al.	2014/0027884	A1	1/2014	Tang et al.
2013/0210241	A1	8/2013	Lavoie et al.	2014/0030447	A1	1/2014	Lee
2013/0213300	A1	8/2013	Sung et al.	2014/0033978	A1	2/2014	Adachi et al.
2013/0214232	A1	8/2013	Tendulkar et al.	2014/0034240	A1	2/2014	Kim et al.
2013/0217239	A1	8/2013	Mallick et al.	2014/0034632	A1	2/2014	Pan et al.
2013/0217240	A1	8/2013	Mallick et al.	2014/0036274	A1	2/2014	Marquardt et al.
2013/0217241	A1	8/2013	Underwood et al.	2014/0045324	A1	2/2014	Brabant et al.
2013/0217243	A1	8/2013	Underwood et al.	2014/0045342	A1	2/2014	Mallick et al.
2013/0219853	A1	8/2013	Little et al.	2014/0047705	A1	2/2014	Singh
2013/0224964	A1	8/2013	Fukazawa	2014/0048765	A1	2/2014	Ma et al.
2013/0228225	A1	9/2013	Leeser	2014/0053866	A1	2/2014	Baluja et al.
2013/0228902	A1	9/2013	Tomizawa et al.	2014/0056679	A1	2/2014	Yamabe et al.
2013/0230814	A1	9/2013	Dunn et al.	2014/0056770	A1	2/2014	Bedard et al.
2013/0234203	A1	9/2013	Tsai et al.	2014/0057187	A1	2/2014	Suzuki et al.
2013/0242287	A1	9/2013	Schlezinger	2014/0057454	A1	2/2014	Subramonium
				2014/0058179	A1	2/2014	Stevens et al.
				2014/0060147	A1	3/2014	Sarin et al.
				2014/0060572	A1	3/2014	Yasumuro et al.
				2014/0061770	A1	3/2014	Lee

(56)

References Cited

U.S. PATENT DOCUMENTS

2014/0062304 A1	3/2014	Nakano et al.	2014/0234550 A1	8/2014	Winter et al.
2014/0065841 A1	3/2014	Matero	2014/0234992 A1	8/2014	Kubota et al.
2014/0067110 A1	3/2014	Lawson et al.	2014/0238607 A1	8/2014	Nozawa et al.
2014/0072710 A1	3/2014	Valle	2014/0238608 A1	8/2014	Sabri et al.
2014/0072726 A1	3/2014	Kim	2014/0242298 A1	8/2014	Lansalot-Matras et al.
2014/0072925 A1	3/2014	Kaneko	2014/0242806 A1	8/2014	Knapp et al.
2014/0073082 A1	3/2014	Song	2014/0242808 A1	8/2014	Akiyama et al.
2014/0073143 A1	3/2014	Alokozai et al.	2014/0245948 A1	9/2014	Nguyen et al.
2014/0076861 A1	3/2014	Cornelius et al.	2014/0251788 A1	9/2014	Ge et al.
2014/0077240 A1	3/2014	Roucka et al.	2014/0251953 A1	9/2014	Winkler et al.
2014/0080314 A1	3/2014	Sasajima et al.	2014/0251954 A1	9/2014	Winkler et al.
2014/0084341 A1	3/2014	Weeks	2014/0252134 A1	9/2014	Chen
2014/0087490 A1	3/2014	Kahlon	2014/0252479 A1	9/2014	Utomo et al.
2014/0087544 A1	3/2014	Tolle	2014/0252710 A1	9/2014	Cuvalci et al.
2014/0087564 A1	3/2014	Shimizu et al.	2014/0260684 A1	9/2014	Christmann
2014/0094027 A1	4/2014	Azumo et al.	2014/0262028 A1	9/2014	Kelekar
2014/0096716 A1	4/2014	Chung et al.	2014/0262034 A1	9/2014	Ishibashi et al.
2014/0097468 A1	4/2014	Okita	2014/0262193 A1	9/2014	Im et al.
2014/0099794 A1	4/2014	Ingle et al.	2014/0263172 A1	9/2014	Xie et al.
2014/0099798 A1	4/2014	Tsuji	2014/0263272 A1	9/2014	Duan et al.
2014/0103145 A1*	4/2014	White H01J 37/32449 239/548	2014/0264297 A1	9/2014	Kumar et al.
			2014/0264444 A1	9/2014	Guo et al.
			2014/0264902 A1	9/2014	Ting et al.
			2014/0265090 A1	9/2014	Hou
			2014/0265832 A1	9/2014	Kenney et al.
			2014/0272194 A1	9/2014	Xiao et al.
			2014/0272341 A1	9/2014	Duan et al.
2014/0106574 A1	4/2014	Kang et al.	2014/0273428 A1	9/2014	Shero
2014/0110798 A1	4/2014	Cai	2014/0273477 A1	9/2014	Niskanen
2014/0113457 A1	4/2014	Sims	2014/0273497 A1	9/2014	Payne et al.
2014/0116335 A1	5/2014	Tsuji et al.	2014/0273510 A1	9/2014	Chen et al.
2014/0117380 A1	5/2014	Loboda et al.	2014/0273528 A1	9/2014	Niskanen
2014/0120487 A1	5/2014	Kaneko	2014/0273530 A1	9/2014	Nguyen
2014/0120678 A1	5/2014	Shinriki et al.	2014/0273531 A1	9/2014	Niskanen
2014/0120723 A1	5/2014	Fu et al.	2014/0283747 A1	9/2014	Kasai et al.
2014/0120738 A1	5/2014	Jung	2014/0287164 A1	9/2014	Xiao et al.
2014/0120750 A1	5/2014	Johnson	2014/0287595 A1	9/2014	Shimamoto et al.
2014/0127907 A1	5/2014	Yang	2014/0290573 A1	10/2014	Okabe et al.
2014/0130687 A1	5/2014	Shibusawa et al.	2014/0290578 A1	10/2014	Wamura et al.
2014/0138779 A1	5/2014	Xie et al.	2014/0306250 A1	10/2014	Gardner et al.
2014/0141165 A1	5/2014	Sato et al.	2014/0308108 A1	10/2014	Fosnight et al.
2014/0141625 A1	5/2014	Fukazawa et al.	2014/0312767 A1	10/2014	Tian et al.
2014/0141674 A1	5/2014	Galbreath et al.	2014/0322862 A1	10/2014	Xie et al.
2014/0144375 A1	5/2014	Kim et al.	2014/0322885 A1	10/2014	Xie et al.
2014/0144500 A1	5/2014	Cao et al.	2014/0339981 A1	11/2014	Komatsu et al.
2014/0145332 A1	5/2014	Ryan et al.	2014/0346142 A1	11/2014	Chapuis et al.
2014/0147587 A1	5/2014	Endo et al.	2014/0346650 A1	11/2014	Raisanen et al.
2014/0148924 A1	5/2014	Brak et al.	2014/0349033 A1	11/2014	Nonaka et al.
2014/0158786 A1	6/2014	Santo	2014/0349068 A1	11/2014	Inglis et al.
2014/0159170 A1	6/2014	Raisanen et al.	2014/0357090 A1	12/2014	Knaepen et al.
2014/0162401 A1	6/2014	Kawano et al.	2014/0360430 A1	12/2014	Armour et al.
2014/0167187 A1	6/2014	Kuo et al.	2014/0363980 A1	12/2014	Kawamata et al.
2014/0170335 A1	6/2014	Shao et al.	2014/0363983 A1	12/2014	Nakano et al.
2014/0174354 A1	6/2014	Arai	2014/0363985 A1	12/2014	Jang et al.
2014/0174357 A1	6/2014	Kim et al.	2014/0366804 A1	12/2014	Pak et al.
2014/0174927 A1	6/2014	Bashir et al.	2014/0367043 A1	12/2014	Bishara et al.
2014/0175054 A1	6/2014	Carlson et al.	2014/0367642 A1	12/2014	Guo
2014/0179091 A1	6/2014	Clark	2014/0377960 A1	12/2014	Koiwa
2014/0179092 A1	6/2014	Kim	2015/0004316 A1	1/2015	Thompson et al.
2014/0182053 A1	7/2014	Huang	2015/0004317 A1	1/2015	Dussarrat et al.
2014/0182689 A1	7/2014	Shareef et al.	2015/0004318 A1	1/2015	Alasaarela et al.
2014/0187022 A1	7/2014	Falster et al.	2015/0004798 A1	1/2015	Chandrasekharan et al.
2014/0187045 A1	7/2014	Hua et al.	2015/0007770 A1*	1/2015	Chandrasekharan C23C 16/45572 118/715
2014/0190581 A1	7/2014	Nagase et al.			
2014/0191389 A1	7/2014	Lee et al.			
2014/0193983 A1	7/2014	Lavoie			
2014/0202382 A1	7/2014	Kim et al.	2015/0010381 A1	1/2015	Cai
2014/0202386 A1	7/2014	Taga	2015/0011095 A1	1/2015	Chandrasekharan et al.
2014/0202388 A1	7/2014	Um et al.	2015/0014632 A1	1/2015	Kim et al.
2014/0209976 A1	7/2014	Yang et al.	2015/0014823 A1	1/2015	Mallikarjunan et al.
2014/0213061 A1	7/2014	Huang et al.	2015/0017794 A1	1/2015	Takamure
2014/0217065 A1	8/2014	Winkler et al.	2015/0021599 A1	1/2015	Ridgeway
2014/0220247 A1	8/2014	Haukka et al.	2015/0024609 A1	1/2015	Milligan et al.
2014/0225065 A1	8/2014	Rachmady et al.	2015/0030766 A1	1/2015	Lind et al.
2014/0227072 A1	8/2014	Lee et al.	2015/0030782 A1	1/2015	Ivanov et al.
2014/0227444 A1	8/2014	Winter et al.	2015/0031218 A1	1/2015	Karakawa
2014/0227861 A1	8/2014	Wu et al.	2015/0034201 A1*	2/2015	Fielding F16L 23/036 138/109
2014/0227881 A1	8/2014	Lubomirsky et al.			
2014/0231922 A1	8/2014	Kim et al.			
2014/0234466 A1	8/2014	Gao et al.	2015/0041431 A1	2/2015	Zafiropoulo et al.
			2015/0048485 A1	2/2015	Tolle

(56)

References Cited

U.S. PATENT DOCUMENTS

2015/0056815 A1	2/2015	Fernandez	2015/0217330 A1	8/2015	Haukka
2015/0056821 A1	2/2015	Ishikawa et al.	2015/0217456 A1	8/2015	Tsuji et al.
2015/0064923 A1	3/2015	Matsumoto et al.	2015/0218695 A1	8/2015	Odedra
2015/0072509 A1	3/2015	Chi et al.	2015/0218698 A1	8/2015	Yoon et al.
2015/0078874 A1	3/2015	Sansoni	2015/0218700 A1	8/2015	Nguyen et al.
2015/0079311 A1	3/2015	Nakano	2015/0221479 A1	8/2015	Chen et al.
2015/0086316 A1	3/2015	Greenberg	2015/0221480 A1	8/2015	Duan et al.
2015/0086716 A1	3/2015	Park et al.	2015/0221519 A1	8/2015	Marks et al.
2015/0087139 A1	3/2015	O'Neill et al.	2015/0225850 A1	8/2015	Arora et al.
2015/0087154 A1	3/2015	Guha et al.	2015/0228513 A1	8/2015	Parkhe et al.
2015/0091057 A1	4/2015	Xie et al.	2015/0228572 A1	8/2015	Yang et al.
2015/0091134 A1	4/2015	Amaratunga et al.	2015/0228645 A1	8/2015	Chuang et al.
2015/0094470 A1	4/2015	Sanchez et al.	2015/0228749 A1	8/2015	Ando et al.
2015/0096973 A1	4/2015	Dunn et al.	2015/0240357 A1	8/2015	Tachibana et al.
2015/0099065 A1	4/2015	Canizares et al.	2015/0240359 A1	8/2015	Jdira et al.
2015/0099072 A1	4/2015	Takamure et al.	2015/0240360 A1	8/2015	Leeser
2015/0099123 A1	4/2015	Barbee et al.	2015/0241787 A1	8/2015	Yaegashi
2015/0099342 A1	4/2015	Tsai	2015/0243522 A1	8/2015	Kitagaito et al.
2015/0099374 A1	4/2015	Kakimoto et al.	2015/0243542 A1	8/2015	Yoshihara et al.
2015/0099375 A1	4/2015	Haripin et al.	2015/0243545 A1	8/2015	Tang
2015/0102466 A1	4/2015	Colinge	2015/0243563 A1	8/2015	Lee et al.
2015/0104574 A1	4/2015	Lee et al.	2015/0243658 A1	8/2015	Joshi et al.
2015/0110147 A1	4/2015	Mizuno	2015/0247259 A1	9/2015	Hekmatshoar-Tabari et al.
2015/0111374 A1	4/2015	Bao	2015/0249013 A1	9/2015	Arghavani et al.
2015/0111395 A1	4/2015	Hashimoto et al.	2015/0255319 A1	9/2015	Kikuchi et al.
2015/0114295 A1	4/2015	Kim et al.	2015/0255324 A1	9/2015	Li et al.
2015/0118009 A1	4/2015	Hsieh et al.	2015/0255385 A1	9/2015	Lee et al.
2015/0118846 A1	4/2015	Isii et al.	2015/0259790 A1	9/2015	Newman
2015/0118863 A1	4/2015	Rathod et al.	2015/0259801 A1	9/2015	Matsumoto et al.
2015/0122180 A1	5/2015	Chang et al.	2015/0262828 A1	9/2015	Brand et al.
2015/0125628 A1	5/2015	Kim et al.	2015/0263033 A1	9/2015	Aoyama
2015/0132212 A1	5/2015	Winkler et al.	2015/0267294 A1	9/2015	Itatani
2015/0140210 A1	5/2015	Jung et al.	2015/0267295 A1	9/2015	Hill et al.
2015/0144060 A1	5/2015	Park	2015/0267297 A1	9/2015	Shiba
2015/0147482 A1	5/2015	Kang et al.	2015/0267298 A1	9/2015	Saitou et al.
2015/0147483 A1	5/2015	Fukazawa	2015/0267299 A1	9/2015	Hawkins
2015/0147488 A1	5/2015	Choi et al.	2015/0267301 A1	9/2015	Hill et al.
2015/0147875 A1	5/2015	Takamure et al.	2015/0270140 A1	9/2015	Gupta et al.
2015/0147877 A1	5/2015	Jung	2015/0270146 A1	9/2015	Yoshihara et al.
2015/0152547 A1	6/2015	Nakamura et al.	2015/0275355 A1	10/2015	Mallikarjunan et al.
2015/0152553 A1	6/2015	Popp et al.	2015/0275357 A1*	10/2015	Kamakura C23C 16/52 438/758
2015/0155177 A1	6/2015	Zhang et al.	2015/0279665 A1	10/2015	Zafiropoulo
2015/0155370 A1	6/2015	Tsai et al.	2015/0279681 A1	10/2015	Knoops
2015/0162168 A1	6/2015	Oehrlie	2015/0279682 A1	10/2015	Nakatani et al.
2015/0162185 A1	6/2015	Pore	2015/0279708 A1	10/2015	Kobayashi et al.
2015/0162214 A1	6/2015	Thompson	2015/0279956 A1	10/2015	Ozaki et al.
2015/0167159 A1	6/2015	Halpin et al.	2015/0280051 A1	10/2015	Xu
2015/0167161 A1	6/2015	Canizares et al.	2015/0284848 A1	10/2015	Nakano et al.
2015/0167162 A1	6/2015	Barik et al.	2015/0287591 A1	10/2015	Pore et al.
2015/0167165 A1	6/2015	Lindfors	2015/0287612 A1	10/2015	Luere et al.
2015/0167705 A1	6/2015	Lee et al.	2015/0287626 A1	10/2015	Arai
2015/0170907 A1	6/2015	Haukka et al.	2015/0287710 A1	10/2015	Yun et al.
2015/0170914 A1	6/2015	Haukka et al.	2015/0291830 A1	10/2015	Galbreath et al.
2015/0170945 A1	6/2015	Segawa et al.	2015/0292088 A1	10/2015	Canizares
2015/0170947 A1	6/2015	Bluck	2015/0299848 A1	10/2015	Haukka et al.
2015/0170954 A1	6/2015	Agarwal	2015/0307982 A1	10/2015	Firouzdor et al.
2015/0170975 A1	6/2015	Blatchford et al.	2015/0307989 A1	10/2015	Lindfors
2015/0171177 A1	6/2015	Cheng et al.	2015/0308586 A1	10/2015	Shugrue et al.
2015/0174768 A1	6/2015	Rodnick	2015/0311151 A1	10/2015	Chi et al.
2015/0175467 A1	6/2015	Denifl et al.	2015/0303056 A1	11/2015	Varadarajan et al.
2015/0176126 A1	6/2015	Ge et al.	2015/0315704 A1	11/2015	Nakano et al.
2015/0179415 A1	6/2015	Sasaki et al.	2015/0322569 A1	11/2015	Kilpi et al.
2015/0179501 A1	6/2015	Jhaveri et al.	2015/0325432 A1	11/2015	Ishizaka
2015/0179564 A1	6/2015	Lee et al.	2015/0332921 A1	11/2015	Lee et al.
2015/0179640 A1	6/2015	Kim et al.	2015/0340247 A1	11/2015	Balakrishnan et al.
2015/0184287 A1	7/2015	Tsung et al.	2015/0340266 A1	11/2015	Ngo et al.
2015/0184291 A1	7/2015	Alokozai et al.	2015/0340500 A1	11/2015	Brunco
2015/0187559 A1	7/2015	Sano	2015/0340609 A1	11/2015	Banno et al.
2015/0187568 A1	7/2015	Pettinger et al.	2015/0343559 A1	12/2015	Morikazu et al.
2015/0187611 A1	7/2015	Sato	2015/0343741 A1	12/2015	Shibata et al.
2015/0187908 A1	7/2015	Zhang et al.	2015/0345018 A1	12/2015	Detavernier et al.
2015/0203961 A1	7/2015	Ha et al.	2015/0345022 A1	12/2015	Yudovsky et al.
2015/0203967 A1	7/2015	Dhas et al.	2015/0348755 A1	12/2015	Han et al.
2015/0211124 A1	7/2015	Nozawa et al.	2015/0349073 A1	12/2015	Kang
2015/0211125 A1	7/2015	Yoshikawa et al.	2015/0353478 A1	12/2015	Hoshino et al.
			2015/0354060 A1	12/2015	Yabe et al.
			2015/0361550 A1	12/2015	Yabe et al.
			2015/0361553 A1	12/2015	Murakawa

(56)

References Cited

U.S. PATENT DOCUMENTS

2015/0364347 A1	12/2015	Nguyen et al.	2016/0177448 A1	6/2016	Ikeda
2015/0364371 A1	12/2015	Yen	2016/0181117 A1	6/2016	Arghavani et al.
2015/0364747 A1	12/2015	Elam et al.	2016/0181128 A1	6/2016	Mori
2015/0367253 A1	12/2015	Kanyal et al.	2016/0181368 A1	6/2016	Weeks
2015/0368798 A1	12/2015	Kwong	2016/0190137 A1	6/2016	Tsai et al.
2015/0371864 A1	12/2015	Hsu et al.	2016/0195331 A1	7/2016	Hyon et al.
2015/0372056 A1	12/2015	Seong et al.	2016/0196969 A1	7/2016	Berry et al.
2015/0376211 A1	12/2015	Girard	2016/0196970 A1	7/2016	Takamure et al.
2015/0376785 A1	12/2015	Knaapen et al.	2016/0203995 A1	7/2016	Kanarik et al.
2015/0380296 A1	12/2015	Antonelli et al.	2016/0204005 A1*	7/2016	Oki C23C 16/46 438/778
2016/0002776 A1	1/2016	Nal et al.	2016/0204436 A1	7/2016	Barker et al.
2016/0002786 A1	1/2016	Gatineau et al.	2016/0211135 A1	7/2016	Noda et al.
2016/0005571 A1	1/2016	Della Rosa et al.	2016/0211147 A1	7/2016	Fukazawa
2016/0005595 A1	1/2016	Liu et al.	2016/0211166 A1	7/2016	Yan et al.
2016/0005839 A1	1/2016	Yieh et al.	2016/0217857 A1	7/2016	Paudel
2016/0010208 A1	1/2016	Huang et al.	2016/0218028 A1	7/2016	Schaller et al.
2016/0013022 A1	1/2016	Ayoub	2016/0222504 A1	8/2016	Haukka et al.
2016/0013024 A1	1/2016	Milligan et al.	2016/0222509 A1	8/2016	Honma
2016/0013086 A1	1/2016	Yang et al.	2016/0222516 A1	8/2016	Ikeda et al.
2016/0017493 A1	1/2016	Dhas	2016/0225607 A1	8/2016	Yamamoto et al.
2016/0020071 A1	1/2016	Khaja et al.	2016/0225632 A1	8/2016	Shaikh et al.
2016/0020092 A1	1/2016	Kang et al.	2016/0245704 A1	8/2016	Osaka et al.
2016/0024655 A1	1/2016	Yudovsky et al.	2016/0256187 A1	9/2016	Shelton et al.
2016/0024656 A1*	1/2016	White C23C 16/4401 239/548	2016/0256187 A1	9/2016	White
2016/0032453 A1	2/2016	Qian et al.	2016/0268102 A1	9/2016	White
2016/0035566 A1	2/2016	LaVoie	2016/0268107 A1	9/2016	Komori et al.
2016/0035596 A1	2/2016	Kamiya	2016/0273101 A1	9/2016	Kanjolia et al.
2016/0042954 A1	2/2016	Sung et al.	2016/0273106 A1	9/2016	Kang
2016/0051964 A1	2/2016	Tolle et al.	2016/0273128 A1	9/2016	Qian et al.
2016/0056074 A1	2/2016	Na	2016/0276148 A1	9/2016	Horikoshi
2016/0056156 A1	2/2016	Ghani et al.	2016/0276212 A1	9/2016	Michishita et al.
2016/0060752 A1	3/2016	Jacques et al.	2016/0279629 A1	9/2016	Sowa et al.
2016/0064208 A1	3/2016	Zafropoulo et al.	2016/0281223 A1	9/2016	Varadarajan et al.
2016/0064231 A1	3/2016	Agarwal et al.	2016/0281230 A1	9/2016	Saido
2016/0069613 A1	3/2016	Colgan et al.	2016/0284517 A1	9/2016	Noda et al.
2016/0071750 A1	3/2016	de Ridder et al.	2016/0284542 A1	9/2016	Shero et al.
2016/0076949 A1	3/2016	Sabah et al.	2016/0289828 A1	10/2016	Danek et al.
2016/0079054 A1	3/2016	Chen et al.	2016/0293398 A1	10/2016	Nakamura et al.
2016/0085003 A1	3/2016	Jaiswal	2016/0305015 A1	10/2016	Lee et al.
2016/0086811 A1	3/2016	Mackedanz et al.	2016/0307739 A1	10/2016	Kim et al.
2016/0087028 A1	3/2016	Hirota et al.	2016/0307740 A1	10/2016	Kim et al.
2016/0097123 A1	4/2016	Shugrue et al.	2016/0307766 A1	10/2016	Jongbloed et al.
2016/0099150 A1	4/2016	Tsai	2016/0312360 A1	10/2016	Rasheed et al.
2016/0099166 A1	4/2016	Yudovsky	2016/0314962 A1	10/2016	Higashino et al.
2016/0099250 A1	4/2016	Rabkin et al.	2016/0314964 A1	10/2016	Tang et al.
2016/0102214 A1	4/2016	Dietz et al.	2016/0314967 A1	10/2016	Tolle
2016/0111272 A1	4/2016	Girard	2016/0315168 A1	10/2016	Dussarrat et al.
2016/0111304 A1	4/2016	Takahashi et al.	2016/0334709 A1	11/2016	Huli et al.
2016/0111438 A1	4/2016	Tsutsumi et al.	2016/0336178 A1	11/2016	Swaminathan et al.
2016/0115590 A1	4/2016	Haukka et al.	2016/0336392 A1	11/2016	Tominaga et al.
2016/0118224 A1	4/2016	Kohno et al.	2016/0345384 A1	11/2016	Zhang et al.
2016/0133307 A1	5/2016	Lee et al.	2016/0351413 A1	12/2016	Schmidt et al.
2016/0133504 A1	5/2016	Chu et al.	2016/0351747 A1	12/2016	Forrest et al.
2016/0133628 A1	5/2016	Xie	2016/0358772 A1	12/2016	Xie
2016/0141172 A1	5/2016	Kang	2016/0362783 A1	12/2016	Tolle et al.
2016/0145738 A1	5/2016	Liu et al.	2016/0362813 A1	12/2016	Bao et al.
2016/0148800 A1	5/2016	Henri et al.	2016/0365280 A1	12/2016	Brink et al.
2016/0148801 A1	5/2016	Yabe et al.	2016/0365414 A1	12/2016	Peng et al.
2016/0148806 A1	5/2016	Henri et al.	2016/0372321 A1	12/2016	Krishnan et al.
2016/0148811 A1	5/2016	Nakatani et al.	2016/0372365 A1	12/2016	Tang et al.
2016/0148821 A1	5/2016	Singh	2016/0372744 A1	12/2016	Essaki et al.
2016/0153088 A1*	6/2016	Tsuji C23C 16/4412 118/728	2016/0376700 A1	12/2016	Haukka
2016/0155629 A1	6/2016	Hawryluk et al.	2016/0376704 A1	12/2016	Raisanen
2016/0163556 A1	6/2016	Briggs et al.	2016/0379826 A9	12/2016	Arghavani et al.
2016/0163558 A1	6/2016	Hudson et al.	2016/0379851 A1	12/2016	Swaminathan et al.
2016/0163561 A1	6/2016	Hudson et al.	2016/0381732 A1	12/2016	Moench et al.
2016/0163711 A1	6/2016	Arndt et al.	2017/0009347 A1	1/2017	Jang et al.
2016/0163972 A1	6/2016	Swaminathan et al.	2017/0009367 A1*	1/2017	Harris C25D 17/06
2016/0168699 A1	6/2016	Fukazawa et al.	2017/0011889 A1	1/2017	Winkler et al.
2016/0169766 A1	6/2016	Ishibashi et al.	2017/0011926 A1	1/2017	Harada et al.
2016/0172189 A1	6/2016	Tapily	2017/0011950 A1	1/2017	Schmotzer
2016/0172296 A1	6/2016	Lim et al.	2017/0018477 A1	1/2017	Kato
2016/0175805 A1	6/2016	Catchpole et al.	2017/0018570 A1	1/2017	Lue et al.
			2017/0025280 A1	1/2017	Milligan
			2017/0025291 A1	1/2017	Lin
			2017/0029945 A1	2/2017	Kamakura
			2017/0032942 A1	2/2017	Walfried
			2017/0032943 A1	2/2017	Spaulding et al.
			2017/0032992 A1	2/2017	Hoechbauer

(56)

References Cited

U.S. PATENT DOCUMENTS

2017/0033004	A1	2/2017	Siew et al.	2017/0243734	A1	8/2017	Ishikawa et al.
2017/0037513	A1	2/2017	Haukka	2017/0250068	A1	8/2017	Ishikawa et al.
2017/0040164	A1	2/2017	Wang et al.	2017/0250075	A1	8/2017	Caymax et al.
2017/0040206	A1	2/2017	Schmotzer et al.	2017/0253968	A1	9/2017	Yahata
2017/0044664	A1	2/2017	Dussarrat et al.	2017/0256393	A1	9/2017	Kim et al.
2017/0044665	A1*	2/2017	Shon C23C 16/5096	2017/0256417	A1	9/2017	Chou
2017/0044666	A1	2/2017	Jang et al.	2017/0256429	A1	9/2017	Lawson et al.
2017/0047446	A1	2/2017	Margetis et al.	2017/0260649	A1	9/2017	Coomer
2017/0051402	A1	2/2017	Mori	2017/0263437	A1	9/2017	Li et al.
2017/0051405	A1	2/2017	Fukazawa et al.	2017/0267527	A1	9/2017	Kim et al.
2017/0051406	A1	2/2017	Mori et al.	2017/0267531	A1	9/2017	Huakka
2017/0051408	A1	2/2017	Kosuke et al.	2017/0271191	A1	9/2017	Yoo et al.
2017/0053811	A1	2/2017	Fung et al.	2017/0271256	A1	9/2017	Inatsuka
2017/0058402	A1	3/2017	Wenxu et al.	2017/0271501	A1	9/2017	Avcı et al.
2017/0062204	A1	3/2017	Suzuki et al.	2017/0278705	A1	9/2017	Murakami et al.
2017/0062209	A1	3/2017	Shiba	2017/0278707	A1	9/2017	Margetis et al.
2017/0062210	A1	3/2017	Visser et al.	2017/0287681	A1	10/2017	Nitadori et al.
2017/0062218	A1	3/2017	Duan et al.	2017/0287744	A1	10/2017	Kobayashi et al.
2017/0062224	A1	3/2017	Fu et al.	2017/0294318	A1	10/2017	Yoshida et al.
2017/0062258	A1	3/2017	Bluck	2017/0294339	A1	10/2017	Tapily
2017/0069725	A1	3/2017	Bhimarasetti et al.	2017/0294499	A1	10/2017	Lu et al.
2017/0091320	A1	3/2017	Psota et al.	2017/0301519	A1	10/2017	Naim et al.
2017/0092469	A1	3/2017	Kurita et al.	2017/0301542	A1	10/2017	Maes et al.
2017/0092531	A1	3/2017	Coomer	2017/0303382	A1	10/2017	Smith et al.
2017/0092535	A1	3/2017	Kimihiko et al.	2017/0306478	A1	10/2017	Raisanen et al.
2017/0092847	A1	3/2017	Kim et al.	2017/0306479	A1	10/2017	Raisanen et al.
2017/0100742	A1	4/2017	Pore et al.	2017/0306480	A1	10/2017	Zhu et al.
2017/0103907	A1	4/2017	Chu et al.	2017/0309490	A1	10/2017	Ogawa
2017/0104061	A1	4/2017	Peng et al.	2017/0309528	A1	10/2017	Bansal et al.
2017/0107621	A1	4/2017	Suemori	2017/0316933	A1	11/2017	Xie et al.
2017/0110313	A1	4/2017	Tang et al.	2017/0316940	A1	11/2017	Ishikawa et al.
2017/0110601	A1	4/2017	Blomberg et al.	2017/0317194	A1	11/2017	Tang et al.
2017/0114460	A1	4/2017	Kim et al.	2017/0323783	A1	11/2017	Sanchez et al.
2017/0114464	A1	4/2017	Iriuda et al.	2017/0323784	A1	11/2017	Faguet et al.
2017/0114465	A1	4/2017	Kalutarage et al.	2017/0338111	A1	11/2017	Takamure et al.
2017/0117141	A1	4/2017	Zhu et al.	2017/0338133	A1	11/2017	Tan et al.
2017/0117202	A1	4/2017	Tang et al.	2017/0338134	A1	11/2017	Tan et al.
2017/0117203	A1	4/2017	Tang et al.	2017/0338192	A1	11/2017	Lee et al.
2017/0117222	A1	4/2017	Kim et al.	2017/0342559	A1	11/2017	Fukazawa et al.
2017/0121845	A1	5/2017	Grutzmacher et al.	2017/0343896	A1	11/2017	Darling et al.
2017/0130332	A1	5/2017	Stumpf	2017/0345674	A1	11/2017	Ranjan et al.
2017/0136578	A1	5/2017	Yoshimura	2017/0350688	A1	12/2017	Boyd et al.
2017/0140925	A1	5/2017	Suzuki et al.	2017/0358445	A1	12/2017	O'Shaughnessy et al.
2017/0145564	A1	5/2017	Bertuch et al.	2017/0358482	A1	12/2017	Chen et al.
2017/0146909	A1	5/2017	Smith et al.	2017/0358670	A1	12/2017	Kub et al.
2017/0148918	A1	5/2017	Ye et al.	2017/0362710	A1	12/2017	Ge et al.
2017/0152968	A1	6/2017	Raj et al.	2017/0365467	A1	12/2017	Shimamoto et al.
2017/0154757	A1	6/2017	Winkler et al.	2017/0372884	A1	12/2017	Margetis et al.
2017/0154770	A1	6/2017	Margetis et al.	2017/0372919	A1	12/2017	Manna et al.
2017/0154895	A1	6/2017	Huo	2017/0373188	A1	12/2017	Mochizuki et al.
2017/0159177	A1	6/2017	Monsma et al.	2018/0005814	A1	1/2018	Kumar et al.
2017/0165624	A1	6/2017	Ravoın et al.	2018/0010243	A1	1/2018	Lee et al.
2017/0167023	A1	6/2017	Praia et al.	2018/0010247	A1	1/2018	Niskanen
2017/0170033	A1	6/2017	Okabe et al.	2018/0011052	A1	1/2018	Andersson et al.
2017/0173696	A1	6/2017	Sheinman	2018/0012792	A1	1/2018	Zhu
2017/0175290	A1	6/2017	Chen et al.	2018/0019165	A1	1/2018	Baum et al.
2017/0178899	A1	6/2017	Kabansky et al.	2018/0025890	A1	1/2018	Choi et al.
2017/0178939	A1	6/2017	Omori	2018/0025907	A1	1/2018	Kalutarage et al.
2017/0178942	A1	6/2017	Sakata et al.	2018/0025939	A1	1/2018	Kovalgin et al.
2017/0179036	A1	6/2017	Chen et al.	2018/0033614	A1	2/2018	Chandra et al.
2017/0186621	A1	6/2017	Zaitsu	2018/0033616	A1	2/2018	Masaru
2017/0186754	A1	6/2017	Blomberg et al.	2018/0033625	A1	2/2018	Yoo
2017/0191159	A1	7/2017	Polyak et al.	2018/0033645	A1	2/2018	Saido et al.
2017/0191164	A1	7/2017	Alokozai et al.	2018/0033674	A1	2/2018	Jeong
2017/0191685	A1	7/2017	Ronne et al.	2018/0033679	A1	2/2018	Pore
2017/0191861	A1	7/2017	Rondano et al.	2018/0040746	A1	2/2018	Johnson et al.
2017/0196562	A1	7/2017	Shelton	2018/0044800	A1	2/2018	Hendrix et al.
2017/0200622	A1	7/2017	Shiokawa et al.	2018/0047591	A1	2/2018	Ogo
2017/0204516	A1	7/2017	Nguyen et al.	2018/0047749	A1	2/2018	Kim
2017/0216762	A1	8/2017	Shugrue et al.	2018/0053660	A1	2/2018	Jandl et al.
2017/0218515	A1	8/2017	Shin et al.	2018/0053769	A1	2/2018	Kim et al.
2017/0222008	A1	8/2017	Hsu et al.	2018/0057931	A1	3/2018	Cha et al.
2017/0226636	A1	8/2017	Xiao	2018/0057934	A1	3/2018	Cooper et al.
2017/0232457	A1	8/2017	Toshiki et al.	2018/0057937	A1	3/2018	Lee et al.
2017/0233868	A1	8/2017	Donoso et al.	2018/0061628	A1	3/2018	Ou et al.
				2018/0061851	A1	3/2018	Ootsuka
				2018/0068844	A1	3/2018	Chen et al.
				2018/0068862	A1	3/2018	Terakura et al.
				2018/0068950	A1	3/2018	Bruley et al.

(56)

References Cited

U.S. PATENT DOCUMENTS

2018/0069019	A1	3/2018	Kim et al.	2018/0305247	A1	10/2018	Feng et al.
2018/0076021	A1	3/2018	Fukushima et al.	2018/0308686	A1	10/2018	Xie et al.
2018/0083435	A1	3/2018	Redler	2018/0308701	A1	10/2018	Na et al.
2018/0087152	A1	3/2018	Yoshida	2018/0312966	A1	11/2018	Chan et al.
2018/0087154	A1	3/2018	Pore et al.	2018/0315838	A1	11/2018	Morrow et al.
2018/0087156	A1	3/2018	Kohei et al.	2018/0323055	A1	11/2018	Woodruff et al.
2018/0090583	A1	3/2018	Choi et al.	2018/0323056	A1	11/2018	Woodruff et al.
2018/0094351	A1	4/2018	Vergheze et al.	2018/0323059	A1	11/2018	Bhargava et al.
2018/0096844	A1	4/2018	Dutartre et al.	2018/0325414	A1	11/2018	Marashdeh et al.
2018/0097076	A1	4/2018	Cheng et al.	2018/0331117	A1	11/2018	Titus et al.
2018/0102276	A1	4/2018	Zhu et al.	2018/0337087	A1	11/2018	Sandhu et al.
2018/0105930	A1	4/2018	Kang et al.	2018/0350587	A1	12/2018	Jia et al.
2018/0108587	A1	4/2018	Jiang	2018/0350588	A1	12/2018	Raisanen et al.
2018/0114680	A1	4/2018	Kim et al.	2018/0350620	A1	12/2018	Zaitsu et al.
2018/0119283	A1	5/2018	Fukazawa	2018/0350653	A1	12/2018	Jeong et al.
2018/0122642	A1	5/2018	Raisanen	2018/0355480	A1	12/2018	Kondo
2018/0122709	A1	5/2018	Xie	2018/0355484	A1	12/2018	Lansalot-Matras et al.
2018/0122959	A1	5/2018	Calka et al.	2018/0358222	A1	12/2018	Venkatasubramanian et al.
2018/0126379	A1	5/2018	Ramsey et al.	2018/0363131	A1	12/2018	Lee et al.
2018/0127876	A1	5/2018	Tolle	2018/0363139	A1	12/2018	Rajavelu et al.
2018/0130652	A1	5/2018	Pettinger et al.	2018/0366314	A1	12/2018	Niskanen et al.
2018/0130701	A1	5/2018	Chun	2018/0371610	A1	12/2018	Banerjee et al.
2018/0135172	A1	5/2018	Nogami et al.	2019/0003050	A1	1/2019	Dezelah et al.
2018/0135173	A1	5/2018	Kim et al.	2019/0003052	A1	1/2019	Shero et al.
2018/0135179	A1	5/2018	Toshiyuki et al.	2019/0006797	A1	1/2019	Paynter et al.
2018/0138036	A1	5/2018	Baldesseroni et al.	2019/0013199	A1	1/2019	Bhargava et al.
2018/0142353	A1	5/2018	Tetsuya et al.	2019/0019670	A1	1/2019	Lin et al.
2018/0142357	A1	5/2018	Yoshikazu	2019/0027573	A1	1/2019	Zhu et al.
2018/0148832	A1	5/2018	Chatterjee et al.	2019/0027583	A1	1/2019	Margetis et al.
2018/0151346	A1	5/2018	Blanquart	2019/0027584	A1	1/2019	Margetis et al.
2018/0151358	A1	5/2018	Margetis et al.	2019/0027605	A1	1/2019	Tolle et al.
2018/0151588	A1	5/2018	Tsutsumi et al.	2019/0032209	A1	1/2019	Huggare
2018/0155832	A1	6/2018	Hamalainen et al.	2019/0032998	A1	1/2019	Jdira et al.
2018/0155836	A1	6/2018	Arai et al.	2019/0035605	A1	1/2019	Suzuki
2018/0158688	A1	6/2018	Chen	2019/0035647	A1	1/2019	Lee et al.
2018/0158699	A1*	6/2018	Kitayama C11D 7/261	2019/0035810	A1	1/2019	Chun et al.
2018/0158716	A1	6/2018	Konkola et al.	2019/0040529	A1	2/2019	Verbaas et al.
2018/0163305	A1	6/2018	Batzer et al.	2019/0046947	A1	2/2019	Strohm et al.
2018/0166258	A1	6/2018	Kim et al.	2019/0051544	A1*	2/2019	Verbaas H01L 21/6719
2018/0166315	A1	6/2018	Coomer	2019/0051548	A1	2/2019	den Hartog Besselink et al.
2018/0171475	A1	6/2018	Maes et al.	2019/0051555	A1	2/2019	Hill et al.
2018/0171477	A1	6/2018	Kim et al.	2019/0057857	A1	2/2019	Ishikawa et al.
2018/0172172	A1	6/2018	Oehler et al.	2019/0057858	A1	2/2019	Hausmann et al.
2018/0173109	A1	6/2018	Gronheid et al.	2019/0058043	A1	2/2019	Dewey et al.
2018/0174801	A1	6/2018	Chen et al.	2019/0062907	A1	2/2019	Kim et al.
2018/0174826	A1	6/2018	Makers et al.	2019/0062917	A1	2/2019	Sung et al.
2018/0179625	A1	6/2018	Takagi et al.	2019/0066978	A1	2/2019	Um et al.
2018/0180509	A1	6/2018	Sawachi et al.	2019/0066997	A1	2/2019	Klaver et al.
2018/0182613	A1	6/2018	Blanquart et al.	2019/0067003	A1	2/2019	Zope et al.
2018/0182618	A1	6/2018	Blanquart et al.	2019/0067004	A1	2/2019	Kohen et al.
2018/0187303	A1	7/2018	Gatineau et al.	2019/0067014	A1	2/2019	Shrestha et al.
2018/0189923	A1	7/2018	Zhong et al.	2019/0067016	A1	2/2019	Zhu et al.
2018/0190496	A1	7/2018	Ashihara et al.	2019/0067085	A1	2/2019	Kweskin
2018/0195174	A1	7/2018	Kim et al.	2019/0067094	A1	2/2019	Zope et al.
2018/0204733	A1	7/2018	Sherpa et al.	2019/0067095	A1	2/2019	Zhu et al.
2018/0211834	A1	7/2018	Takamura et al.	2019/0080903	A1	3/2019	Abel et al.
2018/0223047	A1	8/2018	Xiao et al.	2019/0081072	A1	3/2019	Chun et al.
2018/0223429	A1	8/2018	Fukazawa et al.	2019/0085451	A1	3/2019	Lei et al.
2018/0230595	A1	8/2018	Suda et al.	2019/0086807	A1	3/2019	Kachel et al.
2018/0233372	A1	8/2018	Vayrynen et al.	2019/0088555	A1	3/2019	Xie et al.
2018/0245215	A1	8/2018	Lei et al.	2019/0089143	A1	3/2019	Malone et al.
2018/0246101	A1	8/2018	Sasisekharan et al.	2019/0093221	A1	3/2019	Jdira et al.
2018/0254211	A1	9/2018	Kosakai et al.	2019/0096708	A1	3/2019	Sharma
2018/0258532	A1	9/2018	Kato et al.	2019/0106788	A1	4/2019	Hawkins et al.
2018/0265294	A1	9/2018	Hayashi	2019/0109002	A1	4/2019	Mattinen et al.
2018/0269057	A1	9/2018	Lei et al.	2019/0109009	A1	4/2019	Longrie et al.
2018/0277338	A1	9/2018	Fukada et al.	2019/0112711	A1	4/2019	Lyons et al.
2018/0277423	A1	9/2018	Lottes	2019/0115206	A1	4/2019	Kim et al.
2018/0286638	A1	10/2018	Susa	2019/0115237	A1	4/2019	den Hartog Besselink et al.
2018/0286663	A1	10/2018	Kobayashi et al.	2019/0115451	A1	4/2019	Lee et al.
2018/0286668	A1	10/2018	Baum et al.	2019/0131124	A1	5/2019	Kohen et al.
2018/0286672	A1	10/2018	Van Aerde et al.	2019/0140067	A1	5/2019	Zhu et al.
2018/0286675	A1	10/2018	Blomberg et al.	2019/0148177	A1	5/2019	Yin et al.
2018/0286711	A1	10/2018	Oosterlaken et al.	2019/0148224	A1	5/2019	Kuroda et al.
2018/0294187	A1	10/2018	Thombare et al.	2019/0148398	A1	5/2019	Kim
				2019/0153593	A1	5/2019	Zhu et al.
				2019/0157054	A1	5/2019	White et al.
				2019/0157067	A1	5/2019	Bhuyan et al.
				2019/0163056	A1	5/2019	Maes et al.

(56)

References Cited

U.S. PATENT DOCUMENTS

2019/0164763	A1	5/2019	Raisanen et al.	2020/0052056	A1	2/2020	Park et al.
2019/0176435	A1	6/2019	Bellman et al.	2020/0056282	A1	2/2020	Raisanen et al.
2019/0181002	A1	6/2019	Iijima et al.	2020/0056286	A1	2/2020	Shero et al.
2019/0185999	A1	6/2019	Shanbhag et al.	2020/0063262	A1	2/2020	Katou et al.
2019/0186676	A1*	6/2019	Lopez F16L 3/1025	2020/0064737	A1	2/2020	de Roest
2019/0189447	A1	6/2019	Kamp et al.	2020/0066552	A1	2/2020	Susa
2019/0198359	A1	6/2019	Kamimura et al.	2020/0080200	A1	3/2020	Um et al.
2019/0198571	A1	6/2019	Xu et al.	2020/0083054	A1	3/2020	Väyrynen et al.
2019/0204029	A1	7/2019	Tanabe	2020/0083375	A1	3/2020	Tolle et al.
2019/0217277	A1	7/2019	Jeon et al.	2020/0083469	A1	3/2020	Lhullier
2019/0221433	A1	7/2019	Raisanen et al.	2020/0102649	A1	4/2020	Reed
2019/0229008	A1	7/2019	Rokkam et al.	2020/0102653	A1	4/2020	Muralidhar et al.
2019/0233940	A1	8/2019	Guo et al.	2020/0105579	A1	4/2020	Zhu
2019/0237325	A1	8/2019	Wang et al.	2020/0105594	A1	4/2020	Cheng et al.
2019/0237327	A1	8/2019	Kohen et al.	2020/0109472	A1	4/2020	Um et al.
2019/0244803	A1	8/2019	Suzuki	2020/0111669	A1	4/2020	Zaitsu et al.
2019/0249300	A1	8/2019	Hatanpaa et al.	2020/0111690	A1	4/2020	Oosterlaken
2019/0249303	A1	8/2019	Kuroda et al.	2020/0118811	A1	4/2020	Utsuno et al.
2019/0252195	A1	8/2019	Haukka	2020/0118815	A1	4/2020	Fukazawa et al.
2019/0252196	A1	8/2019	Vayrynen et al.	2020/0118817	A1	4/2020	Blomberg et al.
2019/0259611	A1	8/2019	Nakano et al.	2020/0119038	A1	4/2020	Hopkins et al.
2019/0259612	A1	8/2019	Nozawa et al.	2020/0126771	A1	4/2020	Roh et al.
2019/0264324	A1	8/2019	Shugrue et al.	2020/0126840	A1	4/2020	Roh et al.
2019/0271078	A1	9/2019	Raisanen et al.	2020/0131634	A1	4/2020	Gao et al.
2019/0272981	A1	9/2019	Xu et al.	2020/0135512	A1	4/2020	Oosterlaken et al.
2019/0272993	A1	9/2019	Mattinen et al.	2020/0140995	A1	5/2020	Blanquart et al.
2019/0273133	A1	9/2019	Agrawal et al.	2020/0141003	A1	5/2020	Lee et al.
2019/0276934	A1	9/2019	Vergheze et al.	2020/0144058	A1	5/2020	Kohen
2019/0287769	A1	9/2019	Blomberg et al.	2020/0152473	A1	5/2020	Tapily et al.
2019/0295837	A1	9/2019	Pore et al.	2020/0152750	A1	5/2020	Morrow et al.
2019/0301014	A1	10/2019	Pierreux et al.	2020/0161129	A1	5/2020	Mattinen et al.
2019/0304776	A1	10/2019	Choi	2020/0161438	A1	5/2020	Tang et al.
2019/0304780	A1	10/2019	Kohen et al.	2020/0168485	A1	5/2020	Fluit
2019/0304790	A1	10/2019	Mousa et al.	2020/0279758	A1	5/2020	Sharma
2019/0304821	A1	10/2019	Pierreux et al.	2020/0173020	A1	6/2020	Huggare
2019/0311894	A1	10/2019	Girard et al.	2020/0176244	A1	6/2020	Lee et al.
2019/0311897	A1	10/2019	Kang et al.	2020/0176246	A1	6/2020	Huotari et al.
2019/0311940	A1	10/2019	Choi et al.	2020/0181770	A1	6/2020	Longrie et al.
2019/0318923	A1	10/2019	Blanquart et al.	2020/0185257	A1	6/2020	Nishiwaki
2019/0319100	A1	10/2019	Chen et al.	2020/0194253	A1	6/2020	Banerjee et al.
2019/0322812	A1	10/2019	Wojtecki et al.	2020/0194268	A1	6/2020	Sharma
2019/0330740	A1	10/2019	Klaver	2020/0224309	A1	7/2020	Sreeram et al.
2019/0333753	A1	10/2019	Ueda et al.	2020/0224311	A1	7/2020	Niskanen et al.
2019/0333761	A1	10/2019	Tois et al.	2020/0227243	A1	7/2020	Kim et al.
2019/0338418	A1	11/2019	Goradia et al.	2020/0227250	A1	7/2020	Pore et al.
2019/0346300	A1	11/2019	Kim et al.	2020/0227325	A1	7/2020	Xie et al.
2019/0348261	A1	11/2019	Lin et al.	2020/0232096	A1	7/2020	Hatanpää et al.
2019/0348273	A1	11/2019	Tang et al.	2020/0234989	A1	7/2020	Jeong
2019/0348515	A1	11/2019	Li et al.	2020/0240655	A1*	7/2020	King, Jr. F24F 13/10
2019/0362970	A1	11/2019	Wang et al.	2020/0251328	A1	8/2020	Zaitsu et al.
2019/0362989	A1	11/2019	Reuter et al.	2020/0258766	A1	8/2020	Garssen et al.
2019/0363006	A1	11/2019	Min	2020/0266057	A1	8/2020	Lee et al.
2019/0363015	A1	11/2019	Cheng et al.	2020/0266097	A1	8/2020	Liu et al.
2019/0368040	A1	12/2019	Kachel et al.	2020/0266098	A1	8/2020	Pore et al.
2019/0368041	A1	12/2019	Sreeram et al.	2020/0266208	A1	8/2020	Kim et al.
2019/0371594	A1	12/2019	Niskanen et al.	2020/0270749	A1	8/2020	Li et al.
2019/0371640	A1	12/2019	Raisanen et al.	2020/0270752	A1	8/2020	Pierreux et al.
2019/0375638	A1	12/2019	Haukka	2020/0273729	A1	8/2020	Verbaas et al.
2019/0376180	A1	12/2019	Niskanen	2020/0279721	A1	9/2020	White et al.
2019/0378916	A1	12/2019	Tang et al.	2020/0283893	A1	9/2020	Byun et al.
2019/0385907	A1	12/2019	Gottheim et al.	2020/0283894	A1	9/2020	Lehn et al.
2019/0390338	A1	12/2019	Raisanen et al.	2020/0284467	A1	9/2020	Lindeboom et al.
2019/0390343	A1	12/2019	Min et al.	2020/0286725	A1	9/2020	Sharma et al.
2019/0393304	A1	12/2019	Guillom et al.	2020/0286726	A1	9/2020	Shero et al.
2019/0393308	A1	12/2019	Lo et al.	2020/0294789	A1	9/2020	Woodruff et al.
2020/0002811	A1	1/2020	Sreeram et al.	2020/0303180	A1	9/2020	Kim et al.
2020/0002812	A1	1/2020	Lee et al.	2020/0303196	A1	9/2020	Chen et al.
2020/0013612	A1	1/2020	Blanquart et al.	2020/0309455	A1	10/2020	Fluit
2020/0013613	A1	1/2020	Blanquart	2020/0312652	A1	10/2020	Kang et al.
2020/0013626	A1	1/2020	Longrie et al.	2020/0312681	A1	10/2020	Tanaka et al.
2020/0013629	A1	1/2020	de Roest et al.	2020/0318237	A1	10/2020	Fukazawa
2020/0018421	A1	1/2020	Shugrue	2020/0321209	A1	10/2020	Ishikawa et al.
2020/0035489	A1	1/2020	Huang et al.	2020/0332416	A1	10/2020	Fluit
2020/0040458	A1	2/2020	Ma et al.	2020/0340113	A1	10/2020	Hatanpää et al.
2020/0048768	A1	2/2020	Wiegers et al.	2020/0340138	A1	10/2020	Tolle et al.
				2020/0343134	A1	10/2020	Kovalgin et al.
				2020/0343358	A1	10/2020	Zhu et al.
				2020/0350193	A1	11/2020	Garssen
				2020/0354836	A1	11/2020	Yednak et al.

(56)

References Cited

U.S. PATENT DOCUMENTS

2020/0355296 A1 11/2020 Shugrue et al.
 2020/0357631 A1 11/2020 Ueda
 2020/0365391 A1 11/2020 Blanquart et al.
 2020/0365433 A1 11/2020 de Ridder et al.
 2020/0365434 A1 11/2020 de Ridder
 2020/0365444 A1 11/2020 Hill et al.
 2020/0373152 A1 11/2020 Blanquart
 2020/0385861 A1 12/2020 Deye et al.
 2020/0385867 A1 12/2020 Kim et al.
 2020/0385868 A1 12/2020 Kim et al.
 2020/0395199 A1 12/2020 Miyama
 2020/0395209 A1 12/2020 Yoshimoto et al.
 2020/0395444 A1 12/2020 Lo et al.
 2021/0002762 A1 1/2021 Jun et al.
 2021/0005449 A1 1/2021 Blanquart et al.
 2021/0005450 A1 1/2021 Mattinen et al.
 2021/0005723 A1 1/2021 Tang et al.
 2021/0013010 A1 1/2021 Yoshikawa et al.
 2021/0013037 A1 1/2021 Sun et al.
 2021/0013042 A1 1/2021 Väyrynen et al.
 2021/0013085 A1 1/2021 Roh et al.
 2021/0020429 A1 1/2021 Khazaka et al.
 2021/0020431 A1 1/2021 Blanquart et al.
 2021/0020432 A1 1/2021 Blanquart
 2021/0020467 A1 1/2021 Sekiguchi
 2021/0020470 A1 1/2021 Lee
 2021/0028021 A1 1/2021 Mousa et al.
 2021/0017648 A1 2/2021 Kubota et al.
 2021/0032754 A1 2/2021 White et al.
 2021/0033977 A1 2/2021 Raaijmakers et al.
 2021/0035785 A1* 2/2021 Jeong C23C 16/4412
 2021/0035786 A1 2/2021 Jeong et al.
 2021/0035802 A1 2/2021 Tolle et al.
 2021/0035824 A1 2/2021 de Ridder
 2021/0035839 A1 2/2021 de Ridder
 2021/0035840 A1 2/2021 de Ridder et al.
 2021/0035841 A1 2/2021 Fluit
 2021/0035842 A1 2/2021 de Ridder
 2021/0035854 A1 2/2021 Yoo et al.
 2021/0040613 A1 2/2021 White et al.
 2021/0040615 A1 2/2021 White et al.
 2021/0043444 A1 2/2021 Blanquart
 2021/0050231 A1 2/2021 Oosterlaken
 2021/0054500 A1 2/2021 Zope et al.
 2021/0054504 A1 2/2021 Wang et al.
 2021/0057214 A1 2/2021 Kengoyama et al.
 2021/0057223 A1 2/2021 Stevens et al.
 2021/0057275 A1 2/2021 Pierreux et al.
 2021/0057570 A1 2/2021 Lin et al.
 2021/0066075 A1 3/2021 Zhang et al.
 2021/0066079 A1 3/2021 Lima et al.
 2021/0066080 A1 3/2021 Mattinen et al.
 2021/0066083 A1 3/2021 Haukka
 2021/0066084 A1 3/2021 Raisanen et al.
 2021/0071296 A1 3/2021 Watarai et al.
 2021/0071298 A1 3/2021 Maes et al.
 2021/0074527 A1 3/2021 Lee et al.
 2021/0082692 A1 3/2021 Kikuchi
 2021/0090878 A1 3/2021 Kang et al.
 2021/0095372 A1 4/2021 Minjauw et al.
 2021/0102289 A1 4/2021 Tsuji et al.
 2021/0102290 A1 4/2021 Acosta et al.
 2021/0102292 A1 4/2021 Lin et al.
 2021/0104399 A1 4/2021 Kuroda et al.
 2021/0111025 A1 4/2021 Zyulkov et al.
 2021/0111053 A1 4/2021 De Ridder
 2021/0118667 A1 4/2021 Fukazawa et al.
 2021/0118679 A1 4/2021 Lima et al.
 2021/0118687 A1 4/2021 Wang et al.
 2021/0125827 A1 4/2021 Khazaka et al.
 2021/0125832 A1 4/2021 Bhatnagar
 2021/0134588 A1 5/2021 Kohen et al.
 2021/0134959 A1 5/2021 Lima et al.
 2021/0143003 A1 5/2021 Fukuda et al.
 2021/0151315 A1 5/2021 Pierreux et al.

2021/0151348 A1 5/2021 Utsuno et al.
 2021/0151352 A1 5/2021 Zope et al.
 2021/0156024 A1 5/2021 Roh et al.
 2021/0156030 A1 5/2021 Shugrue
 2021/0159077 A1 5/2021 Longrie et al.
 2021/0166910 A1 6/2021 Kim et al.
 2021/0166924 A1 6/2021 Moon et al.
 2021/0166925 A1 6/2021 Moon et al.
 2021/0041284 A1 11/2021 Yednak

FOREIGN PATENT DOCUMENTS

CN 2588350 11/2003
 CN 1563483 1/2005
 CN 1655362 8/2005
 CN 1664987 9/2005
 CN 1825535 8/2006
 CN 101142012 3/2008
 CN 101609858 12/2009
 CN 101681873 3/2010
 CN 102383106 3/2012
 CN 103014846 4/2013
 CN 102539019 9/2013
 CN 103515222 1/2014
 CN 102373440 7/2014
 CN 203721699 7/2014
 CN 104244620 12/2014
 CN 105253917 1/2016
 CN 104342637 2/2017
 CN 104233226 6/2017
 CN 104201108 11/2017
 CN 104630735 12/2017
 CN 108389798 8/2018
 CN 106011785 10/2018
 DE 8902307 8/1989
 DE 3836696 12/1989
 DE 3626724 6/1994
 DE 10133013 1/2003
 DE 102008052750 6/2009
 EP 0058571 8/1982
 EP 0499004 8/1992
 EP 0634785 1/1995
 EP 0550058 11/1998
 EP 0887632 12/1998
 EP 678909 7/1999
 EP 1061567 12/2000
 EP 1889817 2/2008
 EP 2036600 3/2009
 EP 2426233 7/2012
 FR 686869 7/1930
 FR 1408266 8/1965
 FR 2233614 1/1975
 FR 2517790 6/1983
 FR 2610007 8/1990
 GB 752-277 7/1956
 GB 1186889 6/1966
 GB 1514921 6/1978
 GB 2051875 1/1981
 JP 58-19462 4/1983
 JP S5979545 5/1984
 JP S59127847 7/1984
 JP 59-211779 11/1984
 JP S60110133 6/1985
 JP 61038863 2/1986
 JP S62237236 10/1987
 JP S63136532 6/1988
 JP H01185176 7/1989
 JP H01-296613 11/1989
 JP H01307229 12/1989
 JP H01313954 12/1989
 JP H02-93071 4/1990
 JP H02-185038 7/1990
 JP H02-217469 8/1990
 JP H03-044472 2/1991
 JP H03-155625 7/1991
 JP H03211753 9/1991
 JP H03-248427 11/1991
 JP H04-29313 1/1992
 JP H04-115531 4/1992

(56)

References Cited

FOREIGN PATENT DOCUMENTS			JP	2005172489	6/2005
JP	H05-6880	1/1993	JP	3725100	12/2005
JP	H05-23079	3/1993	JP	2006028572	2/2006
JP	405118928	5/1993	JP	2006049352	2/2006
JP	H05-118928	5/1993	JP	2006059931	3/2006
JP	H05-171446	7/1993	JP	2006090762	4/2006
JP	H05-291142	11/1993	JP	2006124832	5/2006
JP	H06-053210	2/1994	JP	2006153706	6/2006
JP	H06-84888	3/1994	JP	2006186271	7/2006
JP	H06-140399	5/1994	JP	2006188729	7/2006
JP	H0616433	6/1994	JP	2006278058	10/2006
JP	6204231	7/1994	JP	2006319261	11/2006
JP	H06-319177	11/1994	JP	2007027777	2/2007
JP	H06-338497	12/1994	JP	2007287902	11/2007
JP	H07-297271	1/1995	JP	3140111	3/2008
JP	H0729836	1/1995	JP	2008060304	3/2008
JP	07066267	3/1995	JP	2008066159	3/2008
JP	H07-74162	3/1995	JP	2008085129	4/2008
JP	H07-109576	4/1995	JP	2008089320	4/2008
JP	07034936	8/1995	JP	2008172083	7/2008
JP	H07-034936	8/1995	JP	2008198629	8/2008
JP	H07-225214	8/1995	JP	2008202107	9/2008
JP	7-272694	10/1995	JP	2009016815	1/2009
JP	H07-283149	10/1995	JP	2009088421	4/2009
JP	H07-209093	11/1995	JP	2009099938	5/2009
JP	H08-181135	7/1996	JP	2009194248	8/2009
JP	H08-335558	12/1996	JP	2009239082	10/2009
JP	H09-064149	3/1997	JP	2009251216	10/2009
JP	9-89676	4/1997	JP	2009252851	10/2009
JP	H09-148322	6/1997	JP	2010067940	3/2010
JP	H10-41096	2/1998	JP	2010097834	4/2010
JP	H10-50635	2/1998	JP	2010205967	9/2010
JP	H1050800	2/1998	JP	2010251444	10/2010
JP	H10-064696	3/1998	JP	2010255218	11/2010
JP	H10-153494	6/1998	JP	2011049592	3/2011
JP	H10-227703	8/1998	JP	2011162830	8/2011
JP	H10-0261620	9/1998	JP	2011181681	9/2011
JP	H11-097163	4/1999	JP	2009010412	2/2012
JP	H11-118615	4/1999	JP	2012146939	8/2012
JP	H11-183264	7/1999	JP	2012164736	8/2012
JP	H11-183265	7/1999	JP	2012195513	10/2012
JP	H11-195688	7/1999	JP	2013026479	2/2013
JP	H11-287715	10/1999	JP	2013196822	9/2013
JP	2000068355	3/2000	JP	2013235912	11/2013
JP	2000182949	6/2000	JP	D1422467	8/2014
JP	2000269163	9/2000	JP	2014222693	11/2014
JP	2001015698	1/2001	JP	2015021175	2/2015
JP	2001023872	1/2001	JP	2015115461	6/2015
JP	2001207265	7/2001	JP	2016098406	5/2016
JP	2001207268	7/2001	JP	2010123843	6/2016
JP	2001210602	8/2001	JP	2016174158	9/2016
JP	2001220677	8/2001	JP	2017183242	10/2017
JP	2001257199	9/2001	JP	6519897	5/2019
JP	2001287180	10/2001	KR	1998-0026850	7/1998
JP	2002164342	6/2002	KR	20000000946	1/2000
JP	2002170781	6/2002	KR	10-0253664	4/2000
JP	2002237375	8/2002	KR	10-2000-0031098	6/2000
JP	2003035574	2/2003	KR	10-2000-0045257	7/2000
JP	2003053688	2/2003	KR	100273261	12/2000
JP	2003133300	5/2003	KR	10-0295043	4/2001
JP	2003153706	5/2003	KR	10-2002-0027695	4/2002
JP	2003303814	10/2003	KR	10-2002-0064028	8/2002
JP	2004014952	1/2004	KR	2002-0086763	11/2002
JP	2004023043	1/2004	KR	10-0377095	3/2003
JP	2004091848	3/2004	KR	2003-0092305	12/2003
JP	2004113270	4/2004	KR	10-2005-0054122	6/2005
JP	2004128019	4/2004	KR	10-0547248	1/2006
JP	2004134553	4/2004	KR	10-0593960	6/2006
JP	2004163293	6/2004	KR	10-2006-0129566	12/2006
JP	2004244661	9/2004	KR	10-0688484	2/2007
JP	2004294638	10/2004	KR	10-2007-0079797	8/2007
JP	3589954	11/2004	KR	10-2007-0084683	8/2007
JP	2004310019	11/2004	KR	20080058620	6/2008
JP	2005033221	2/2005	KR	10-2009-0039936	4/2009
JP	2005079254	3/2005	KR	10-2009-0055443	6/2009
JP	2005507030	3/2005	KR	10-2009-0056475	6/2009
			KR	10-2009-0086790	8/2009
			KR	10-2009-0105977	10/2009
			KR	10-0936694	1/2010

(56)

References Cited

FOREIGN PATENT DOCUMENTS		
KR	10-2010-0015073	2/2010
KR	10-2010-0020834	2/2010
KR	10-2010-0032812	3/2010
KR	10-2010-0077442	7/2010
KR	10-2010-0079920	7/2010
KR	10-2010-0122701	11/2010
KR	10-2010-0132779	12/2010
KR	10-2011-0058534	6/2011
KR	10-1114219	3/2012
KR	20120111060	10/2012
KR	10-2013-0007806	1/2013
KR	10-2013-0067600	6/2013
KR	10-2013-0129149	11/2013
KR	10-1347962	1/2014
KR	101491726	2/2015
KR	10-1535573	7/2015
KR	10-2019-0032077	3/2019
NL	8600255	9/1987
NL	8701549	2/1989
RU	1786406	1/1993
SU	494614	2/1976
SU	1408319	7/1988
TW	538327	6/2003
TW	540093	7/2003
TW	M292692	6/2006
TW	200731357	8/2007
TW	200903625	1/2009
TW	201213596	4/2012
TW	201234453	8/2012
TW	201247690	12/2012
TW	M446412	2/2013
TW	201330086	7/2013
TW	D162593	8/2014
TW	D164568	12/2014
TW	201531587	8/2015
TW	M512254	11/2015
TW	I514509	12/2015
TW	201613231	4/2016
TW	M553518	12/2017
TW	D196097	2/2019
WO	1987001508	3/1987
WO	1990004045	4/1990
WO	1991004522	4/1991
WO	1991006975	5/1991
WO	1992000477	1/1992
WO	1994027315	11/1994
WO	1996017107	6/1996
WO	1997003223	1/1997
WO	1998032893	7/1998
WO	1999023690	5/1999
WO	DM/048579	7/1999
WO	2004008491	7/2002
WO	2004008827	1/2004
WO	2004010467	1/2004
WO	2004106584	12/2004
WO	2005112082	11/2005
WO	2006035281	4/2006
WO	2006054854	5/2006
WO	2006056091	6/2006
WO	2006078666	7/2006
WO	2006080782	8/2006
WO	2006097525	9/2006
WO	2006101857	9/2006
WO	2006114781	11/2006
WO	2007024720	3/2007
WO	2007027165	3/2007
WO	2007076195	7/2007
WO	2007117718	10/2007
WO	2007131051	11/2007
WO	2007140376	12/2007
WO	2008045972	4/2008
WO	2008091900	7/2008
WO	2008121463	10/2008
WO	2008147731	12/2008
WO	2009028619	3/2009

WO	2009029532	3/2009
WO	2009039251	3/2009
WO	2009099776	8/2009
WO	2009154889	12/2009
WO	2009154896	12/2009
WO	2010039363	4/2010
WO	2010077533	7/2010
WO	2010100702	9/2010
WO	2010110558	9/2010
WO	2010118051	10/2010
WO	2010129428	11/2010
WO	2010129430	11/2010
WO	2010129431	11/2010
WO	2011019950	2/2011
WO	2011149640	12/2011
WO	2012056592	5/2012
WO	2012077590	6/2012
WO	2013043330	3/2013
WO	2013078065	5/2013
WO	2013078066	5/2013
WO	2013177269	11/2013
WO	2014107290	7/2014
WO	2015026230	2/2015
WO	2015107009	7/2015
WO	2015112728	7/2015
WO	2018109553	6/2016
WO	2018109554	6/2016
WO	2017108713	6/2017
WO	2017108714	6/2017
WO	2017212546	12/2017
WO	2018003072	1/2018
WO	2018008088	1/2018
WO	2018013778	1/2018
WO	2018020316	2/2018
WO	2018020318	2/2018
WO	2018020320	2/2018
WO	2018020327	2/2018
WO	2018105349	6/2018
WO	2018109551	6/2018
WO	2018109552	6/2018
WO	2018178771	10/2018
WO	2019030565	2/2019
WO	2019103610	5/2019
WO	2019103613	5/2019
WO	2019142055	7/2019
WO	2019158960	8/2019
WO	2019217749	11/2019
WO	2019229537	12/2019
WO	2020002995	1/2020
WO	2020003000	1/2020

OTHER PUBLICATIONS

Danco 86786 Slip Joint Nut and Washer, Oct. 3, 2006, Amazon, site visited Nov. 15, 2021: <https://www.amazon.com/dp/B000JFLMW6/> (Year: 2006).*

CNIPA; Office Action dated Jan. 21, 2020 in Application No. 201610028064.1.

CNIPA; Office Action dated Feb. 28, 2020 in Application No. 201610897958.4.

EPO; Extended European Search Report dated Mar. 3, 2020 in Application No. 19205558.0.

KIPO; Office Action dated Feb. 28, 2020 in Application No. 10-2013-0049598.

KIPO; Notice of Allowance dated Feb. 27, 2020 in Application No. 10-2013-0089998.

KIPO; Notice of Allowance dated Mar. 4, 2020 in Application No. 10-2013-0114079.

KIPO; Office Action dated Mar. 30, 2020 in Application No. 10-2014-0011764.

KIPO; Office Action dated Mar. 11, 2020 in Application No. 10-2014-0103853.

KIPO; Office Action dated Feb. 12, 2020 in Application No. 10-2020-7000992.

TIPO; Notice of Allowance dated Feb. 20, 2020 in Application No. 102125191.

(56)

References Cited

OTHER PUBLICATIONS

- TIPO; Office Action dated Jan. 17, 2020 in Application No. 104108277.
TIPO; Notice of Allowance dated Jan. 15, 2020 in Application No. 105114105.
TIPO; Notice of Allowance dated Mar. 13, 2020 in Application No. 105119533.
TIPO; Office Action dated Jan. 17, 2020 in Application No. 105122586.
TIPO; Office Action dated Jan. 17, 2020 in Application No. 107127688.
TIPO; Office Action dated Dec. 24, 2019 in Application No. 108105002.
TIPO; Office Action dated Feb. 3, 2020 in Application No. 108114221.
TIPO; Notice of Allowance dated Mar. 12, 2020 in Application No. 108129100.
USPTO; Final Office Action dated Feb. 20, 2020 in U.S. Appl. No. 14/444,744.
USPTO; Non-Final Office Action dated Mar. 5, 2020 in U.S. Appl. No. 14/508,489.
USPTO; Final Office Action dated Mar. 3, 2020 in U.S. Appl. No. 14/829,565.
USPTO; Notice of Allowance dated Mar. 5, 2020 in U.S. Appl. No. 15/060,412.
USPTO; Advisory Action dated Mar. 31, 2020 in U.S. Appl. No. 15/286,503.
USPTO; Final Office Action dated Feb. 19, 2020 in U.S. Appl. No. 15/402,993.
USPTO; Advisory Action dated Apr. 2, 2020 in U.S. Appl. No. 15/402,993.
USPTO; Notice of Allowance dated Feb. 28, 2020 in U.S. Appl. No. 15/589,849.
USPTO; Non-Final Office Action dated Mar. 10, 2020 in U.S. Appl. No. 15/611,707.
USPTO; Notice of Allowance dated Feb. 28, 2020 in U.S. Appl. No. 15/615,489.
USPTO; Non-Final Office Action dated Mar. 11, 2020 in U.S. Appl. No. 15/636,307.
USPTO; Final Office Action dated Mar. 27, 2020 in U.S. Appl. No. 15/672,096.
USPTO; Advisory Action dated Mar. 16, 2020 in U.S. Appl. No. 15/726,959.
USPTO; Non-Final Office Action dated Apr. 3, 2020 in U.S. Appl. No. 15/726,959.
USPTO; Notice of Allowance dated Mar. 12, 2020 in U.S. Appl. No. 15/795,056.
USPTO; Final Office Action dated Mar. 19, 2020 in U.S. Appl. No. 15/798,201.
USPTO; Final Office Action dated Mar. 11, 2020 in U.S. Appl. No. 15/802,154.
USPTO; Advisory Action dated Mar. 25, 2020 in U.S. Appl. No. 15/815,483.
USPTO; Non-Final Office Action dated Mar. 17, 2020 in U.S. Appl. No. 15/835,328.
USPTO; Non-Final Office Action dated Feb. 20, 2020 in U.S. Appl. No. 15/835,352.
USPTO; Non-Final Office Action dated Mar. 30, 2020 in U.S. Appl. No. 15/860,564.
USPTO; Non-Final Office Action dated Mar. 20, 2020 in U.S. Appl. No. 15/861,418.
USPTO; Final Office Action dated Feb. 26, 2020 in U.S. Appl. No. 15/890,037.
USPTO; Non-Final Office Action dated Mar. 24, 2020 in U.S. Appl. No. 15/896,986.
USPTO; Notice of Allowance dated Mar. 27, 2020 in U.S. Appl. No. 15/897,578.
USPTO; Final Office Action dated Mar. 12, 2020 in U.S. Appl. No. 15/923,834.
USPTO; Final Office Action dated Feb. 19, 2020 in U.S. Appl. No. 15/940,759.
USPTO; Notice of Allowance dated Mar. 12, 2020 in U.S. Appl. No. 15/949,990.
USPTO; Non-Final Office Action dated Apr. 2, 2020 in U.S. Appl. No. 15/974,948.
USPTO; Notice of Allowance dated Apr. 3, 2020 in U.S. Appl. No. 15/985,261.
USPTO; Non-Final Office Action dated Apr. 1, 2020 in U.S. Appl. No. 15/997,445.
USPTO; Non-Final Office Action dated Mar. 3, 2020 in U.S. Appl. No. 16/000,109.
USPTO; Advisory Action dated Apr. 3, 2020 in U.S. Appl. No. 16/000,125.
USPTO; Non-Final Office Action dated Mar. 4, 2020 in U.S. Appl. No. 16/036,692.
USPTO; Advisory Action dated Feb. 28, 2020 in U.S. Appl. No. 16/038,024.
USPTO; Notice of Allowance dated Mar. 23, 2020 in U.S. Appl. No. 16/038,024.
USPTO; Notice of Allowance dated Apr. 3, 2020 in U.S. Appl. No. 16/039,867.
USPTO; Non-Final Office Action dated Feb. 20, 2020 in U.S. Appl. No. 16/105,745.
USPTO; Non-Final Office Action dated Feb. 24, 2020 in U.S. Appl. No. 16/105,761.
USPTO; Non-Final Office Action dated Mar. 19, 2020 in U.S. Appl. No. 16/105,802.
USPTO; Non-Final Office Action dated Mar. 16, 2020 in U.S. Appl. No. 16/116,708.
USPTO; Non-Final Office Action dated Feb. 6, 2020 in U.S. Appl. No. 16/117,530.
USPTO; Non-Final Office Action dated Feb. 28, 2020 in U.S. Appl. No. 16/137,974.
USPTO; Final Office Action dated Mar. 2, 2020 in U.S. Appl. No. 16/158,077.
USPTO; Final Office Action dated Mar. 17, 2020 in U.S. Appl. No. 16/161,744.
USPTO; Notice of Allowance dated Mar. 5, 2020 in U.S. Appl. No. 16/167,225.
USPTO; Non-Final Office Action dated Feb. 19, 2020 in U.S. Appl. No. 16/242,829.
USPTO; Final Office Action dated Jan. 10, 2020 in U.S. Appl. No. 16/251,534.
USPTO; Advisory Action dated Apr. 3, 2020 in U.S. Appl. No. 16/251,534.
USPTO; Notice of Allowance dated Apr. 15, 2020 in U.S. Appl. No. 16/317,774.
USPTO; Non-Final Office Action dated Mar. 2, 2020 in U.S. Appl. No. 16/356,394.
USPTO; Notice of Allowance dated Mar. 30, 2020 in U.S. Appl. No. 16/417,938.
USPTO; Final Office Action dated Jan. 10, 2020 in U.S. Appl. No. 16/674,894.
WIPO; International Search Report and Written Opinion dated Apr. 17, 2019 in Application No. PCT/NL2018/050787.
WIPO; International Search Report and Written Opinion dated Apr. 29, 2019 in Application No. PCT/NL2018/050791.
Rossing et al. "Acoustics of Eastern and Western bells, Old and New" J of Acoustical Society of Japan; 10(5); pp. 241-252 (1989).
CNIPA; Notice of Allowance dated Dec. 21, 2020 in Application No. 201610982040.X.
CNIPA; Office Action dated Nov. 20, 2020 in Application No. 201710762817.6.
CNIPA; Notice of Allowance dated Dec. 28, 2020 in Application No. 201930704935.1.
CNIPA; Notice of Allowance dated Dec. 10, 2020 in Application No. 202030352604.9.
CNIPA; Office Action dated Jan. 25, 2021 in Application No. 202030579755.8.
JPO; Notice of Allowance dated Nov. 27, 2020 in Application No. 2016-206625.
JPO; Office Action dated Jan. 26, 2021 in Application No. 2017-139817.
JPO; Notice of Allowance dated Nov. 26, 2020 in Application No. 2020-502653.

(56)

References Cited

OTHER PUBLICATIONS

KIPO; Office Action dated Jan. 25, 2021 in Application No. 10-2014-0011765.
KIPO; Notice of Allowance dated Jan. 4, 2021 in Application No. 10-2014-0060120.
KIPO; Notice of Allowance dated Jan. 4, 2021 in Application No. 10-2014-0071653.
KIPO; Office Action dated Nov. 29, 2020 in Application No. 10-2014-0105478.
KIPO; Office Action dated Feb. 17, 2021 in Application No. 10-2014-0122903.
KIPO; Office Action dated Jan. 25, 2021 in Application No. 10-2014-0145220.
KIPO; Office Action dated Jan. 6, 2021 in Application No. 10-2015-0025314.
KIPO; Office Action dated Dec. 23, 2020 in Application No. 10-2019-0044213.
KIPO; Office Action dated Nov. 14, 2020 in Application No. 10-2020-0101096.
KIPO; Notice of Allowance dated Oct. 20, 2020 in Application No. 30-2019-0054642.
KIPO; Notice of Allowance dated Oct. 22, 2020 in Application No. 30-2019-0058566 (M001).
KIPO; Notice of Allowance dated Oct. 22, 2020 in Application No. 30-2019-0058566 (M002).
KIPO; Notice of Allowance dated Dec. 1, 2020 in Application No. 30-2019-0061607.
KIPO; Office Action dated Jan. 26, 2021 in Application No. 30-2020-0005953 (M001).
KIPO; Office Action dated Jan. 26, 2021 in Application No. 30-2020-0005953 (M002).
KIPO; Notice of Allowance dated Dec. 23, 2020 in Application No. 30-2020-0006059.
KIPO; Notice of Allowance dated Dec. 25, 2020 in Application No. 30-2020-0006223.
KIPO; Notice of Allowance dated Feb. 1, 2021 in Application No. 30-2020-0006385.
KIPO; Notice of Allowance dated Feb. 1, 2021 in Application No. 30-2020-0006391.
TIPO; Office Action dated Dec. 2, 2020 in Application No. 105131896.
TIPO; Notice of Allowance dated Jan. 29, 2021 in Application No. 105142668.
TIPO; Notice of Allowance dated Dec. 10, 2020 in Application No. 106108152.
TIPO; Notice of Allowance dated Jan. 25, 2021 in Application No. 106111548.
TIPO; Office Action dated Sep. 30, 2020 in Application No. 106113604.
TIPO; Office Action dated Jan. 6, 2021 in Application No. 106115126.
TIPO; Office Action dated Dec. 21, 2020 in Application No. 106122231.
TIPO; Office Action dated Dec. 29, 2020 in Application No. 106124126.
TIPO; Office Action dated Dec. 9, 2020 in Application No. 106124128.
TIPO; Office Action dated Jan. 25, 2021 in Application No. 106124129.
TIPO; Office Action dated Dec. 9, 2020 in Application No. 106124130.
TIPO; Office Action dated Jan. 20, 2021 in Application No. 106129491.
TIPO; Office Action dated Feb. 8, 2021 in Application No. 106133152.
TIPO; Notice of Allowance dated Nov. 24, 2020 in Application No. 108307599.
TIPO; Notice of Allowance dated Jan. 11, 2021 in Application No. 108307599D01.
TIPO; Notice of Allowance dated Jan. 11, 2021 in Application No. 109300591.
TIPO; Notice of Allowance dated Jan. 11, 2021 in Application No. 109300593.
TIPO; Office Action dated Jan. 11, 2021 in Application No. 109300594.
USPTO; Non-Final Office Action dated Dec. 1, 2020 in U.S. Appl. No. 14/219,879.

USPTO; Final Office Action dated Feb. 1, 2021 in U.S. Appl. No. 14/829,565.
USPTO; Non-Final Office Action dated Dec. 24, 2020 in U.S. Appl. No. 15/286,503.
USPTO; Final Office Action dated Feb. 12, 2021 in U.S. Appl. No. 15/377,439.
USPTO Non-Final Office Action dated Dec. 10, 2020 in Application No. 15/380,921.
USPTO; Non-Final Office Action dated Feb. 3, 2021 in U.S. Appl. No. 15/611,707.
USPTO; Final Office Action dated Jan. 19, 2021 in U.S. Appl. No. 15/636,307.
USPTO; Non-Final Office Action dated Jan. 6, 2021 in U.S. Appl. No. 15/726,959.
USPTO; Advisory Action dated Dec. 15, 2020 in U.S. Appl. No. 15/835,328.
USPTO; Notice of Allowance dated Jan. 14, 2021 in U.S. Appl. No. 15/835,352.
USPTO; Final Office Action dated Jan. 11, 2021 in U.S. Appl. No. 15/890,037.
USPTO; Advisory Action dated Jan. 8, 2021 in U.S. Appl. No. 15/923,834.
USPTO; Advisory Action dated Dec. 24, 2020 in U.S. Appl. No. 15/925,532.
USPTO; Non-Final Office Action dated Jan. 25, 2021 in U.S. Appl. No. 15/925,532.
USPTO; Final Office Action dated Feb. 18, 2021 in U.S. Appl. No. 15/940,729.
USPTO; Final Office Action dated Jan. 12, 2021 in U.S. Appl. No. 15/940,759.
USPTO; Final Office Action dated Dec. 15, 2020 in U.S. Appl. No. 15/962,980.
USPTO; Advisory Action dated Oct. 27, 2020 in U.S. Appl. No. 15/974,948.
USPTO; Advisory Action dated Dec. 10, 2020 in U.S. Appl. No. 16/000,109.
USPTO; Advisory Action dated Dec. 15, 2020 in U.S. Appl. No. 16/000,125.
USPTO; Advisory Action dated Dec. 14, 2020 in U.S. Appl. No. 16/000,156.
USPTO; Advisory Action dated Dec. 22, 2020 in U.S. Appl. No. 16/004,041.
USPTO; Non-Final Office Action dated Nov. 24, 2020 in U.S. Appl. No. 16/039,938.
USPTO; Advisory Action dated Jan. 14, 2021 in U.S. Appl. No. 16/055,532.
USPTO; Final Office Action dated Dec. 15, 2020 in U.S. Appl. No. 16/108,950.
USPTO; Final Office Action dated Jan. 6, 2021 in U.S. Appl. No. 16/117,530.
USPTO; Notice of Allowance dated Feb. 12, 2021 in U.S. Appl. No. 16/128,282.
USPTO; Notice of Allowance dated Feb. 8, 2021 in U.S. Appl. No. 16/132,142.
USPTO; Final Office Action dated Dec. 14, 2020 in U.S. Appl. No. 16/151,074.
USPTO; Advisory Action dated Feb. 16, 2021 in U.S. Appl. No. 16/151,074.
USPTO; Final Office Action dated Dec. 18, 2020 in U.S. Appl. No. 16/167,164.
USPTO; Advisory Action dated Dec. 21, 2020 in U.S. Appl. No. 16/172,535.
USPTO; Final Office Action dated Jan. 29, 2021 in U.S. Appl. No. 16/176,517.
USPTO; Non-Final Office Action dated Dec. 11, 2021 in U.S. Appl. No. 16/202,941.
USPTO; Final Office Action dated Dec. 9, 2020 in U.S. Appl. No. 16/210,922.
USPTO; Notice of Allowance dated Dec. 15, 2020 in U.S. Appl. No. 16/242,852.
USPTO; Advisory Action dated Jan. 22, 2021 in U.S. Appl. No. 16/252,567.

(56)

References Cited

OTHER PUBLICATIONS

- USPTO; Final Office Action dated Dec. 8, 2020 in U.S. Appl. No. 16/397,045.
- USPTO; Advisory Action dated Jan. 27, 2021 in U.S. Appl. No. 16/397,045.
- USPTO; Final Office Action dated Dec. 14, 2020 in U.S. Appl. No. 16/400,814.
- USPTO; Non-Final Office Action dated Jan. 12, 2021 in U.S. Appl. No. 16/453,249.
- USPTO; Non-Final Office Action dated Dec. 28, 2020 in U.S. Appl. No. 16/517,122.
- USPTO; Non-Final Office Action dated Feb. 11, 2021 in U.S. Appl. No. 16/565,460.
- USPTO; Notice of Allowance dated Jan. 25, 2021 in U.S. Appl. No. 16/679,885.
- USPTO; Non-Final Office Action dated Feb. 8, 2021 in U.S. Appl. No. 16/685,787.
- USPTO; Non-Final Office Action dated Jan. 8, 2021 in U.S. Appl. No. 16/752,514.
- USPTO; Notice of Allowance dated Dec. 28, 2020 in U.S. Appl. No. 16/833,279.
- USPTO; Notice of Allowance dated Nov. 23, 2020 in U.S. Appl. No. 29/726,623.
- Aoyagi et al. "Laser-assisted atomic layer epitaxy" *Materials Science and Engineering*, pp. 121-132 (1991).
- Galesic et al. "Formation of vanadium nitride by rapid thermal processing" *Thin Solid Films* 349(1), 7 pages (1999).
- Kim et al. "High Growth Rate in Atomic Layer Deposition of TiO₂ Thin Films by UV Irradiation" *Electrochemical and Solid-State Letters*, 14(4), pp. H146-H148 (2011).
- Lee et al. "Enhancement of Iodine Adsorption on Ruthenium Glue Layer for Seedless CECVD of Cu" *Electrochemical and Solid-State Letters*, 8(2) C39-C42 (2005).
- Lee et al. "Growth without Postannealing of Monoclinic VO₂ Thin Film by Atomic Layer Deposition Using VC14 as Precursor" *Coatings*, 8, 431, pp. 1-11 (2018).
- Lee et al. "Photo-Induced Atomic Layer Deposition of Tantalum Oxide Thin Films from Ta(OC₂H₅)₅ and O₂" *J of the Electrochemical Society*. 151(1) pp. C52-C55 (2004).
- Merdrignac-Conanec et al. "Nitridation under ammonia of high surface area vanadium aerogels" *Journal of Solid State Chemistry* 178(1), 8 pages (2005).
- Nikolic et al. "The dependence of the work function of rare earth metals on their electron structure" *Microelectronics Journal* 27, 93-96 (1996).
- Putkonen et al. "Low-Temperature ALE Deposition of Y₂O₃ Thin Films from β -Diketonate Precursors" *Chemical Vapor Deposition* 7(1) pp. 44-50 (2001).
- US PPA 62274238 filed Jan. 1, 2016 in the names of Alexander S. Polyak et al., and entitled "Non-Metallic Thermal CVD/ALD Gas Injector and Purge System" pp. 1-63 (2016).
- Vayrynen et al. "Photo-Assisted Atomic Layer Deposition and Chemical Vapor Deposition of Metal and Metal Oxide Thin Films" Thesis, Oct. 2015, 146 pages (2005).
- CNIPA; Notice of Allowance dated May 22, 2020 in Application No. 201610028064.1.
- CNIPA; Office Action dated Mar. 26, 2020 in Application No. 201610131743.1.
- CNIPA; Office Action dated May 18, 2020 in Application No. 201610982040.X.
- CNIPA; Office Action dated May 29, 2020 in Application No. 201710131319.1.
- CNIPA; Office Action dated Jun. 1, 2020 in Application No. 201710173292.2.
- CNIPA; Notice of Allowance dated May 14, 2020 in Application No. 201930615780.4.
- CNIPA; Notice of Allowance dated Apr. 27, 2020 in Application No. 201930660355.7.
- CNIPA; Notice of Allowance dated Jun. 2, 2020 in Application No. 202030048819.1.
- CNIPA; Notice of Allowance dated May 15, 2020 in Application No. 202030048854.3.
- CNIPA; Notice of Allowance dated May 15, 2020 in Application No. 202030053560.X.
- CNIPA; Notice of Allowance dated May 20, 2020 in Application No. 202030053634.X.
- KIPO; Notice of Allowance dated Apr. 23, 2020 in Application No. 10-2013-0050740.
- KIPO; Office Action dated Jun. 19, 2020 in Application No. 10-2013-0098575.
- KIPO; Notice of Allowance dated May 14, 2020 in Application No. 10-2013-0102026.
- KIPO; Office Action dated May 21, 2020 in Application No. 10-2014-0086902.
- KIPO; Office Action dated May 21, 2020 in Application No. 10-2014-0091092.
- KIPO; Office Action dated Apr. 22, 2020 in Application No. 10-2020-0009462.
- TIPO; Notice of Allowance dated May 4, 2020 in Application No. 105101536.
- TIPO; Office Action dated Apr. 14, 2020 in Application No. 105129977.
- TIPO; Office Action dated Mar. 17, 2020 in Application No. 105130130.
- TIPO; Office Action dated Feb. 21, 2020 in Application No. 108120947.
- USPTO; Advisory Action dated Apr. 24, 2020 in U.S. Appl. No. 14/219,839.
- USPTO; Advisory Action dated Apr. 24, 2020 in U.S. Appl. No. 14/219,879.
- USPTO; Non-Final Office Action dated Apr. 28, 2020 in U.S. Appl. No. 14/444,744.
- USPTO; Final Office Action dated May 15, 2020 in U.S. Appl. No. 14/457,058.
- USPTO; Advisory Action dated Jun. 22, 2020 in U.S. Appl. No. 14/829,565.
- USPTO; Final Office Action dated Jun. 1, 2020 in U.S. Appl. No. 15/135,258.
- USPTO; Non-Final Office Action dated Apr. 16, 2020 in U.S. Appl. No. 15/286,503.
- USPTO; Final Office Action dated May 13, 2020 in U.S. Appl. No. 15/377,439.
- USPTO; Non-Final Office Action dated May 27, 2020 in U.S. Appl. No. 15/402,993.
- USPTO; Final Office Action dated Apr. 17, 2020 in U.S. Appl. No. 15/491,726.
- USPTO; Final Office Action dated Jun. 16, 2020 in U.S. Appl. No. 15/636,307.
- USPTO; Notice of Allowance dated May 20, 2020 in U.S. Appl. No. 15/672,096.
- USPTO; Final Office Action dated May 27, 2020 in U.S. Appl. No. 15/690,017.
- USPTO; Advisory Action dated Jun. 19, 2020 in U.S. Appl. No. 15/691,241.
- USPTO; Advisory Action dated May 26, 2020 in U.S. Appl. No. 15/798,201.
- USPTO; Advisory Action dated May 19, 2020 in U.S. Appl. No. 15/802,154.
- USPTO; Non-Final Office Action dated Apr. 24, 2020 in U.S. Appl. No. 15/815,483.
- USPTO; Final Office Action dated Jun. 11, 2020 in U.S. Appl. No. 15/861,418.
- USPTO; Advisory Action dated Jun. 5, 2020 in U.S. Appl. No. 15/890,037.
- USPTO; Final Office Action dated Jun. 15, 2020 in U.S. Appl. No. 15/896,986.
- USPTO; Non-Final Office Action dated May 1, 2020 in U.S. Appl. No. 15/917,224.
- USPTO; Advisory Action dated May 15, 2020 in U.S. Appl. No. 15/923,834.
- USPTO; Non-Final Office Action dated May 1, 2020 in U.S. Appl. No. 15/925,532.

(56)

References Cited

OTHER PUBLICATIONS

- USPTO; Advisory Action dated Apr. 23, 2020 in U.S. Appl. No. 15/940,759.
- USPTO; Final Office Action dated Apr. 30, 2020 in U.S. Appl. No. 15/962,980.
- USPTO; Non-Final Office Action dated May 15, 2020 in U.S. Appl. No. 15/974,988.
- USPTO; Non-Final Office Action dated Jun. 12, 2020 in U.S. Appl. No. 15/985,539.
- USPTO; Non-Final Office Action dated Feb. 20, 2020 in U.S. Appl. No. 15/996,286.
- USPTO; Non-Final Office Action dated Jun. 5, 2020 in U.S. Appl. No. 16/000,125.
- USPTO; Non-Final Office Action dated Apr. 22, 2020 in U.S. Appl. No. 16/000,156.
- USPTO; Non-Final Office Action dated May 7, 2020 in U.S. Appl. No. 16/004,041.
- USPTO; Notice of Allowance dated Jun. 24, 2020 in U.S. Appl. No. 16/014,981.
- USPTO; Notice of Allowance dated May 26, 2020 in U.S. Appl. No. 16/036,692.
- USPTO; Non-Final Office Action dated Apr. 30, 2020 in U.S. Appl. No. 16/055,532.
- USPTO; Non-Final Office Action dated May 27, 2020 in U.S. Appl. No. 16/100,012.
- USPTO; Final Office Action dated Jun. 23, 2020 in U.S. Appl. No. 16/105,745.
- USPTO; Final Office Action dated Apr. 21, 2020 in U.S. Appl. No. 16/105,761.
- USPTO; Final Office Action dated Jun. 26, 2020 in U.S. Appl. No. 16/105,802.
- USPTO; Non-Final Office Action dated Jun. 22, 2020 in U.S. Appl. No. 16/128,282.
- USPTO; Non-Final Office Action dated Apr. 21, 2020 in U.S. Appl. No. 16/130,798.
- USPTO; Final Office Action dated Jun. 5, 2020 in U.S. Appl. No. 16/132,142.
- USPTO; Advisory Action dated Jun. 9, 2020 in U.S. Appl. No. 16/158,077.
- USPTO; Notice of Allowance dated Jun. 19, 2020 in U.S. Appl. No. 16/161,744.
- USPTO; Non-Final Office Action dated May 29, 2020 in U.S. Appl. No. 16/205,899.
- USPTO; Final Office Action dated Jun. 19, 2020 in U.S. Appl. No. 16/219,555.
- USPTO; Final Office Action dated Jun. 15, 2020 in U.S. Appl. No. 16/242,829.
- USPTO; Notice of Allowance dated May 29, 2020 in U.S. Appl. No. 16/245,006.
- USPTO; Non-Final Office Action dated Apr. 24, 2020 in U.S. Appl. No. 16/251,534.
- USPTO; Non-Final Office Action dated May 27, 2020 in U.S. Appl. No. 16/252,567.
- USPTO; Non-Final Office Action dated Apr. 16, 2020 in U.S. Appl. No. 16/255,639.
- USPTO; Non-Final Office Action dated Jun. 30, 2020 in U.S. Appl. No. 16/258,187.
- USPTO; Notice of Allowance dated May 21, 2020 in U.S. Appl. No. 16/280,964.
- USPTO; Notice of Allowance dated Apr. 16, 2020 in U.S. Appl. No. 16/427,288.
- USPTO; Non-Final Office Action dated May 12, 2020 in U.S. Appl. No. 16/454,063.
- USPTO; Notice of Allowance dated Apr. 17, 2020 in U.S. Appl. No. 16/455,406.
- USPTO; Non-Final Office Action dated Jun. 11, 2020 in U.S. Appl. No. 16/598,768.
- USPTO; Notice of Allowance dated Apr. 21, 2020 in U.S. Appl. No. 16/674,894.
- USPTO; Non-Final Office Action dated Apr. 13, 2020 in U.S. Appl. No. 16/833,279.
- USPTO; Notice of Allowance dated Jun. 10, 2020 in U.S. Appl. No. 29/615,000.
- USPTO; Non-Final Office Action dated Apr. 24, 2020 in U.S. Appl. No. 29/726,623.
- Chatterjee et al. "Chemical Vapor Deposition of Boron Nitride Nanosheets on Metallic Substrates via Decaborane/Ammonia Reactions", *Chem. Mater.* 23, pp. 4414-4416 (2011).
- Fallica et al., "Dynamic Absorption Coefficients Of Chemically Amplified Resists And Nonchemically Amplified Resists At Extreme Ultraviolet", *J. Micro/Nanolith. MEMS MOEMS* 15(3), pp. 033506-1-033506-7 (2016).
- Glass et al. "The Chemical Vapor Deposition of Metal Boride Thin Films from Polyhedral Cluster Species", Winter and Hoffman, *Inorganic Materials Synthesis. ACS Symposium Series; American Chemical Society: Washington DC, Chapter 10*, pp. 130-143 (1999).
- Jensen et al. "Titanium, Zirconium, and Hafnium Tetrahydroborates as "Tailored" CVD Precursors for Metal Diboride Thin Films", *J. Am. Chem. Soc.* 110, pp. 1643-1644 (1988).
- Kliem et al. "Silyl Group Migrations Between Oxygen and Nitrogen in Aminosiloxanes"; *Organosilicon Chemistry VI: from Molecules to Materials*; pp. 216-221 (2005).
- Lewis et al. "Hawley's Condensed Chemical Dictionary" 12th Edition; excerpt pp. 1027-1038 (2005).
- Roddy, "Transport Reactions and Vaporization Studies of Some Vanadium Halides", Iowa State university of Science and Technology dissertation, 207 pages (1962).
- Spear et al., "Chemical Transport Reactions in the Vanadium-Silicon-Oxygen System and the Ternary Phase Diagram", *Journal of the Less-Common Metals*, 14, pp. 69-75 (1968).
- Su et al. "A Polymer Precursor Route to Metal Borides", *Chem. Mater.*, 5, pp. 1659-1668 (1993).
- CNIPA; Notice of Allowance dated Dec. 27, 2019 in Application No. 201510765406.3.
- CNIPA; Office Action dated Nov. 4, 2019 in Application No. 201610898822.5.
- CNIPA; Office Action dated Nov. 11, 2019 in Application No. 201810379112.0.
- EPO; Extended European Search Report dated Nov. 29, 2019 in Application No. 19188826.2.
- JPO; Notice of Allowance dated Nov. 20, 2019 in Application No. JP2015034774.
- JPO; Notice of Allowance dated Dec. 17, 2019 in Application No. 2016001928.
- KIPO; Office Action dated Nov. 29, 2019 in Application No. 10-2013-0088450.
- KIPO; Notice of Allowance dated Jan. 13, 2020 in Application No. 10-2013-0088450.
- KIPO; Notice of Allowance dated Oct. 30, 2019 in Application No. 10-2013-0084459.
- KIPO; Office Action dated Dec. 4, 2019 in Application No. 10-2013-0098575.
- KIPO; Office Action dated Feb. 3, 2020 in Application No. 10-2014-0021615.
- KIPO; Office Action dated Feb. 15, 2020 in Application No. 10-2014-0027305.
- TIPO; Notice of Allowance dated Jan. 7, 2020 in Application No. 102136496.
- TIPO; Notice of Allowance dated Nov. 27, 2019 in Application No. 104141679.
- TIPO; Office Action dated Dec. 13, 2019 in Application No. 105101536.
- TIPO; Office Action dated Dec. 13, 2019 in Application No. 105111990.
- TIPO; Notice of Allowance dated Dec. 10, 2019 in Application No. 105112363.
- TIPO; Notice of Allowance dated Feb. 10, 2020 in Application No. 105115513.
- TIPO; Notice of Allowance dated Feb. 13, 2020 in Application No. 105122715.
- TIPO; Office Action dated Jan. 20, 2020 in Application No. 105122394.

(56)

References Cited

OTHER PUBLICATIONS

- TIPO; Notice of Allowance dated Jan. 16, 2020 in Application No. 107116804.
- TIPO; Office Action dated Nov. 13, 2019 in Application No. 108115406.
- USPTO; Notice of Allowance dated Feb. 10, 2020 in U.S. Appl. No. 13/651,144.
- USPTO; Notice of Allowance dated Feb. 10, 2020 in U.S. Appl. No. 14/188,760.
- USPTO; Final Office Action dated Jan. 27, 2020 in U.S. Appl. No. 14/219,839.
- USPTO; Final Office Action dated Jan. 13, 2020 in U.S. Appl. No. 14/219,879.
- USPTO; Final Office Action dated Dec. 26, 2019 in U.S. Appl. No. 15/060,412.
- USPTO; Advisory Action dated Jan. 3, 2020 in U.S. Appl. No. 15/135,258.
- USPTO; Non-Final Office Action dated Feb. 13, 2020 in U.S. Appl. No. 15/135,258.
- USPTO; Notice of Allowance dated Dec. 3, 2019 in U.S. Appl. No. 15/205,827.
- USPTO; Final Office Action dated Nov. 19, 2019 in U.S. Appl. No. 15/262,990.
- USPTO; Advisory Action dated Jan. 30, 2020 in U.S. Appl. No. 15/262,990.
- USPTO; Final Office Action dated Jan. 6, 2020 in U.S. Appl. No. 15/286,503.
- USPTO; Final Office Action dated Dec. 12, 2019 in U.S. Appl. No. 15/380,909.
- USPTO; Non-Final Office Action dated Jan. 15, 2020 in Application No. 15/380,921.
- USPTO; Final Office Action dated Jan. 8, 2020 in U.S. Appl. No. 15/589,849.
- USPTO; Non-Final Office Action dated Jan. 13, 2020 in U.S. Appl. No. 15/589,861.
- USPTO; Advisory Action dated Jan. 17, 2020 in U.S. Appl. No. 15/636,307.
- USPTO; Notice of Allowance dated Feb. 7, 2020 in U.S. Appl. No. 15/672,119.
- USPTO; Final Office Action dated Jan. 24, 2020 in U.S. Appl. No. 15/691,241.
- USPTO; Notice of Allowance dated Jan. 29, 2020 in U.S. Appl. No. 15/719,208.
- USPTO; Final Office Action dated Jan. 7, 2020 in U.S. Appl. No. 15/726,959.
- USPTO; Notice of Allowance dated Jan. 6, 2020 in U.S. Appl. No. 15/727,432.
- USPTO; Non-Final Office Action dated Jun. 14, 2019 in U.S. Appl. No. 15/796,593.
- USPTO; Notice of Allowance dated Dec. 31, 2019 in U.S. Appl. No. 15/796,593.
- USPTO; Final Office Action dated Jan. 13, 2020 in U.S. Appl. No. 15/815,483.
- USPTO; Advisory Action dated Jan. 21, 2020 in U.S. Appl. No. 15/860,564.
- USPTO; Notice of Allowance dated Jan. 16, 2020 in U.S. Appl. No. 15/879,209.
- USPTO; Advisory Action dated Feb. 7, 2020 in U.S. Appl. No. 15/896,986.
- USPTO; Notice of Allowance dated Dec. 17, 2019 in U.S. Appl. No. 15/900,425.
- USPTO; Advisory Action dated Nov. 27, 2019 in U.S. Appl. No. 15/917,224.
- USPTO; Non-Final Office Action dated Dec. 23, 2019 in U.S. Appl. No. 15/923,834.
- USPTO; Final Office Action dated Nov. 27, 2019 in U.S. Appl. No. 15/925,532.
- USPTO; Non-Final Rejection dated Nov. 29, 2019 in U.S. Appl. No. 15/949,990.
- USPTO; Non-Final Office Action dated Jan. 31, 2020 in U.S. Appl. No. 15/962,980.
- USPTO; Non-Final Office Action dated Jan. 16, 2020 in U.S. Appl. No. 15/985,261.
- USPTO; Final Office Action dated Jan. 13, 2020 in U.S. Appl. No. 16/000,125.
- USPTO; Non-Final Office Action dated Jan. 16, 2020 in U.S. Appl. No. 16/014,981.
- USPTO; Non-Final Office Action dated Dec. 11, 2019 in U.S. Appl. No. 16/018,692.
- USPTO; Notice of Allowance dated Jan. 30, 2020 in U.S. Appl. No. 16/018,692.
- USPTO; Notice of Allowance dated Nov. 26, 2019 in Application No. 16/024,390.
- USPTO; Final Office Action dated Nov. 29, 2019 in U.S. Appl. No. 16/038,024.
- USPTO; Final Office Action dated Jan. 28, 2020 in U.S. Appl. No. 16/039,867.
- USPTO; Non-Final Office Action dated Jan. 6, 2020 in U.S. Appl. No. 16/132,142.
- USPTO; Notice of Allowance dated Jan. 3, 2020 in U.S. Appl. No. 16/147,047.
- USPTO; Non-Final Office Action dated Nov. 5, 2019 in U.S. Appl. No. 16/152,260.
- USPTO; Final Office Action dated Dec. 16, 2019 in U.S. Appl. No. 16/167,225.
- USPTO; Notice of Allowance dated Dec. 16, 2019 in U.S. Appl. No. 16/188,690.
- USPTO; Notice of Allowance dated Jan. 28, 2020 in U.S. Appl. No. 16/208,062.
- USPTO; Notice of Allowance dated Dec. 9, 2019 in U.S. Appl. No. 16/213,702.
- USPTO; Non-Final Office Action dated Jan. 8, 2020 in U.S. Appl. No. 16/219,555.
- USPTO; Non-Final Office Action dated Jan. 30, 2020 in U.S. Appl. No. 16/245,006.
- USPTO; Non-Final Office Action dated Dec. 18, 2019 in U.S. Appl. No. 16/280,964.
- USPTO; Non-Final Office Action dated Jan. 9, 2020 in U.S. Appl. No. 16/317,774.
- USPTO; Non-Final Office Action dated Dec. 26, 2019 in U.S. Appl. No. 16/417,938.
- USPTO; Non-Final Office Action dated Dec. 31, 2019 in U.S. Appl. No. 16/427,288.
- USPTO; Non-Final Office Action dated Dec. 31, 2019 in U.S. Appl. No. 16/455,406.
- USPTO; Ex Parte Quayle Action dated Dec. 17, 2019 in U.S. Appl. No. 29/615,000.
- USPTO; Notice of Allowance dated Jan. 23, 2020 in U.S. Appl. No. 29/634,768.
- WIPO; International Search Report and Written Opinion dated Nov. 19, 2019 in Application No. PCT/IB2019/000127.
- WIPO; International Search Report and Written Opinion dated Jan. 10, 2020 in Application No. PCT/IB2019/000729.
- WIPO; International Search Report and Written Opinion dated Dec. 20, 2019 in Application No. PCT/IB2019/000805.
- WIPO; International Search Report and Written Opinion dated Dec. 20, 2019 in Application No. PCT/IB2019/000817.
- Alen, "Atomic layer deposition of TaN, NbN and MoN films for Cu Metallizations," University of Helsinki Finland, 72 pages, (2005).
- Hamalainen et al., "Atomic Layer Deposition of Rhenium Disulfide," *Adv. Mater.* 30.24, 6 pages (2018).
- Hargreaves et al., "New Fluorides and Oxyfluorides of Rhenium," *J. Chem. Soc.*, pp. 1099-1103 (1960).
- IPS Water Heater Pan Adapter Kit, Nov. 1, 2015, [online], [site visited Dec. 4, 2019]; URL: <http://es.ipscorp.com/watertite/protectivesystem/whpanadapter> (2015).
- Qin et al., "Chemical Vapor Deposition Growth of Degenerate p-Type Mo-Doped ReS₂ Films and Their Homojunction," *ACS Appl. Mater. Interfaces*, 9(18), pp. 15583-15591 (2007).
- Rhenium trioxide; https://en.wikipedia.org/wiki/Rhenium_trioxide [online]; last edited on Feb. 18, 2017.

(56)

References Cited

OTHER PUBLICATIONS

- Saeki et al. "Reaction Process of Vanadium Tetrachloride with Ammonia in the Vapor Phase and Properties of the Vanadium Nitride Formed" Bull. Chem. Soc. Jpn., 55, pp. 3446-3449 (1982).
CNIPA; Office Action dated Jan. 10, 2013 in Application No. 201080015699.9.
CNIPA; Office Action dated Aug. 1, 2013 in Application No. 201080015699.9.
CNIPA; Office Action dated Jan. 21, 2014 in Application No. 201080015699.9.
CNIPA; Office Action dated Jul. 25, 2014 in Application No. 201080015699.9.
CNIPA; Office Action dated Jan. 12, 2015 in Application No. 201080015699.9.
CNIPA; Office Action dated May 8, 2015 in Application No. 201080015699.9.
CNIPA; Office Action dated Dec. 10, 2013 in Application No. 201080020267.7.
CNIPA; Notice of Allowance dated Aug. 22, 2014 in Application No. 201080020267.7.
CNIPA; Office Action dated Jan. 21, 2013 in Application No. 201080020268.1.
CNIPA; Office Action dated Sep. 26, 2013 in Application No. 201080020268.1.
CNIPA; Office Action dated Apr. 3, 2014 in Application No. 201080020268.1.
CNIPA; Office Action dated Sep. 23, 2014 in Application No. 201080020268.1.
CNIPA; Office Action dated Apr. 7, 2015 in Application No. 201080020268.1.
CNIPA; Notice of Allowance dated Oct. 16, 2015 in Application No. 201080020268.1.
CNIPA; Office Action dated May 24, 2013 in Application No. 201080036764.6.
CNIPA; Office Action dated Jan. 2, 2014 in Application No. 201080036764.6.
CNIPA; Office Action dated Jul. 1, 2014 in Application No. 201080036764.6.
CNIPA; Notice of Allowance dated Oct. 24, 2014 in Application No. 201080036764.6.
CNIPA; Office Action dated Feb. 8, 2014 in Application No. 201110155056.0.
CNIPA; Office Action dated Sep. 16, 2014 in Application No. 201110155056.0.
CNIPA; Office Action dated Feb. 9, 2015 in Application No. 201110155056.0.
CNIPA; Notice of Allowance dated Aug. 26, 2015 in Application No. 201110155056.0.
CNIPA; Office Action dated Dec. 4, 2015 in Application No. 201210201995.9.
CNIPA; Office Action dated Jul. 14, 2016 in Application No. 201210201995.9.
CNIPA; Office Action dated Jan. 20, 2017 in Application No. 201210201995.9.
CNIPA; Notice of Allowance dated Apr. 13, 2017 in Application No. 201210201995.9.
CNIPA; Office Action dated Dec. 24, 2015 in Application No. 201280057466.4.
CNIPA; Notice of Allowance dated Jun. 16, 2016 in Application No. 201280057466.4.
CNIPA; Office Action dated Dec. 4, 2015 in Application No. 201280057542.1.
CNIPA; Office Action dated May 16, 2016 in Application No. 201280057542.1.
CNIPA; Office Action dated Sep. 9, 2016 in Application No. 201280057542.1.
CNIPA; Notice of Allowance dated Jan. 3, 2017 in Application No. 201280057542.1.
CNIPA; Office Action dated Dec. 5, 2016 in Application No. 201310412808.6.
CNIPA; Notice of Allowance dated Jul. 20, 2017 in Application No. 201310412808.6.
CNIPA; Office Action dated Feb. 5, 2018 in Application No. 201410331047.6.
CNIPA; Office Action dated Dec. 14, 2018 in Application No. 201410331047.6.
CNIPA; Notice of Allowance dated Jun. 14, 2019 in Application No. 201410331047.6.
CNIPA; Office Action dated Jun. 28, 2019 in Application No. 201510765170.3.
CNIPA; Office Action dated Oct. 19, 2018 in Application No. 201510765170.3.
CNIPA; Office Action dated Oct. 31, 2018 in Application No. 201510765406.3.
CNIPA; Office Action dated Jun. 28, 2019 in Application No. 201510765406.3.
CNIPA; Office Action dated Mar. 14, 2019 in Application No. 201610141027.1.
CNIPA; Office Action dated Dec. 20, 2018 in Application No. 201710738549.4.
CNIPA; Office Action dated Jun. 20, 2019 in Application No. 201711120632.1.
CNIPA; Notice of Allowance dated May 25, 2017 in Application No. 201730010308.9.
CNIPA; Notice of Allowance dated Oct. 24, 2018 in Application No. 201830060972.9.
CNIPA; Notice of Allowance dated Nov. 1, 2018 in Application No. 201830397219.9.
EPO; Supplementary European Search Report and Opinion dated Nov. 9, 2012 in Application No. 08798519.8.
EPO; Office Action dated Jul. 18, 2016 in Application No. 08798519.8.
EPO; Extended European Search Report dated Dec. 9, 2016 in Application No. 9767208.3.
EPO; Office Action dated Aug. 10, 2018 in Application No. 09767208.3.
EPO; Supplementary European Search Report and Opinion dated Jan. 5, 2017 in Application No. 09836647.9.
EPO; Office Action dated Feb. 28, 2018 in Application No. 09836647.9.
EPO; Office Action dated Jan. 11, 2019 in Application No. 09836647.9.
EPO; Extended European Search Report dated Apr. 28, 2014 in Application No. 11162225.4.
EPO; Notice of Allowance dated Feb. 3, 2015 in Application No. 11162225.4.
IPOS; Notice of Allowance dated Aug. 14, 2017 in Application No. 10201401237.
JPO; Office Action dated Aug. 10, 2009 in Application No. 2003029767.
JPO; Office Action dated Apr. 13, 2010 in Application No. 2003029767.
JPO; Notice of Allowance dated Jun. 24, 2010 in Application No. 2003029767.
JPO; Office Action dated Oct. 30, 2008 in Application No. 2004558313.
JPO; Office Action dated Feb. 19, 2009 in Application No. 2004558313.
JPO; Notice of Allowance dated Jun. 30, 2009 in Application No. 2004558313.
JPO; Office Action dated Mar. 16, 2012 in Application No. 2009-532567.
JPO; Notice of Allowance dated Jul. 23, 2012 in Application No. 2009-532567.
JPO; Notice of Allowance dated Mar. 29, 2013 in Application No. 2010-509478.
JPO; Office Action dated Dec. 20, 2011 in Application No. 2010-522075.
JPO; Office Action dated Apr. 11, 2012 in Application No. 2010-522075.
JPO; Office Action dated May 15, 2013 in Application No. 2010058415.
JPO; Office Action dated Oct. 30, 2013 in Application No. 2010058415.
JPO; Office Action dated Aug. 7, 2014 in Application No. 2010058415.
JPO; Notice of Allowance dated Dec. 18, 2014 in Application No. 2010058415.
JPO; Office Action dated Aug. 22, 2013 in Application No. 2010-153754.

(56)

References Cited

OTHER PUBLICATIONS

JPO; Office Action dated Oct. 30, 2013 in Application No. 2010-193285.
JPO; Office Action dated Aug. 26, 2015 in Application No. 2011-284831.
JPO; Notice of Allowance dated Mar. 3, 2016 in Application No. 2011-284831.
JPO; Office Action dated May 31, 2012 in Application No. 2011-514650.
JPO; Office Action dated Sep. 11, 2012 in Application No. 2011-514650.
JPO; Notice of Allowance dated Dec. 10, 2012 in Application No. 2011-514650.
JPO; Office Action dated Dec. 10, 2014 in Application No. 2011090067.
JPO; Notice of Allowance dated Apr. 28, 2015 in Application No. 2011090067.
JPO; Office Action dated Jul. 14, 2016 in Application No. 2012-153698.
JPO; Notice of Allowance dated Oct. 21, 2016 in Application No. 2012-153698.
JPO; Office Action dated Dec. 20, 2013 in Application No. 2012-504786.
JPO; Office Action dated Jan. 25, 2014 in Application No. 2012-504786.
JPO; Office Action dated Dec. 1, 2014 in Application No. 2012-504786.
JPO; Notice of Allowance dated Jun. 12, 2015 in Application No. 2012504786.
JPO; Office Action dated Mar. 11, 2013 in Application No. 2012-509857.
JPO; Notice of Allowance dated Jun. 29, 2013 in Application No. 2012-509857.
JPO; Office Action dated May 19, 2017 in Application No. 2013-160173.
JPO; Notice of Allowance dated Aug. 23, 2017 in Application No. 2013-160173.
JPO; Office Action dated Aug. 14, 2017 in Application No. 2013-178344.
JPO; Office Action dated Jan. 23, 2018 in Application No. 2013-178344.
JPO; Notice of Allowance dated Jul. 24, 2018 in Application No. 2013-178344.
JPO; Office Action dated Apr. 3, 2018 in Application No. 2014-120675.
JPO; Notice of Allowance dated Jun. 6, 2018 in Application No. 2014-120675.
JPO; Office Action dated Mar. 28, 2018 in Application No. 2014-188835.
JPO; Notice of Allowance dated Jun. 6, 2018 in Application No. 2014-188835.
JPO; Office Action dated Apr. 12, 2018 in Application No. 2014-205548.
JPO; Notice of Allowance dated Dec. 19, 2019 in Application No. 2014205548.
JPO; Notice of Allowance dated May 14, 2018 in Application No. 2014-216540.
JPO; Office Action dated Jul. 20, 2018 in Application No. 2015-034774.
JPO; Office Action dated Jun. 27, 2019 in Application No. 2015034774.
JPO; Office Action dated Jan. 30, 2019 in Application No. 2015052198.
JPO; Notice of Allowance dated Apr. 5, 2019 in Application No. 2015052198.
KIPO; Office Action dated Dec. 10, 2015 in Application No. 10-2010-0028336.
KIPO; Office Action dated Jun. 29, 2016 in Application No. 10-2010-0028336.
KIPO; Notice of Allowance dated Sep. 29, 2016 in Application No. 10-2010-0028336.
KIPO; Office Action dated Mar. 3, 2016 in Application No. 10-2010-0067768.

KIPO; Office Action dated Aug. 1, 2016 in Application No. 10-2010-0067768.
KIPO; Notice of Allowance dated Dec. 1, 2016 in Application No. 10-2010-0067768.
KIPO; Office Action dated May 2, 2016 in Application No. 10-2010-0082446.
KIPO; Office Action dated Sep. 19, 2016 in Application No. 10-2010-0082446.
KIPO; Notice of Allowance dated Mar. 7, 2017 in Application No. 10-2010-0082446.
KIPO; Office Action dated Mar. 13, 2017 in Application No. 20110034612.
KIPO; Office Action dated Jul. 20, 2017 in Application No. 20110034612.
KIPO; Notice of Allowance dated Sep. 1, 2017 in Application No. 20110034612.
KIPO; Office Action dated Nov. 24, 2017 in Application No. 10-2011-0036449.
KIPO; Office Action dated May 23, 2017 in Application No. 10-2011-0036449.
KIPO; Office Action dated Apr. 2, 2018 in Application No. 10-2011-0036449.
KIPO; Notice of Allowance dated Oct. 24, 2018 in Application No. 10-2011-0036449.
KIPO; Office Action dated Sep. 4, 2017 in Application No. 10-2011-0087600.
KIPO; Notice of Allowance dated Jan. 11, 2018 in Application No. 10-2011-0087600.
KIPO; Office Action dated Oct. 23, 2017 in Application No. 10-2011-0142924.
KIPO; Notice of Allowance dated Mar. 14, 2018 in Application No. 10-2011-0142924.
KIPO; Office Action dated Dec. 11, 2015 in Application No. 10-2011-7023416.
KIPO; Office Action dated Mar. 13, 2016 in Application No. 10-2011-7023416.
KIPO; Notice of Allowance dated Jun. 2, 2016 in Application No. 10-2011-7023416.
KIPO; Office Action dated Mar. 21, 2018 in Application No. 10-2012-0004520.
KIPO; Office Action dated Oct. 30, 2017 in Application No. 10-2012-0041878.
KIPO; Notice of Allowance dated Feb. 28, 2018 in Application No. 10-2012-0041878.
KIPO; Office Action dated Mar. 21, 2018 in Application No. 10-2012-0042518.
KIPO; Notice of Allowance dated May 30, 2018 in Application No. 10-2012-0042518.
KIPO; Office Action dated Mar. 21, 2018 in Application No. 10-2012-0064526.
KIPO; Office Action dated Sep. 18, 2018 in Application No. 10-2012-0064526.
KIPO; Office Action dated Dec. 13, 2018 in Application No. 10-2012-0064526.
KIPO; Office Action dated Jan. 12, 2019 in Application No. 10-2012-0064526.
KIPO; Office Action dated Mar. 30, 2018 in Application No. 10-2012-0076564.
KIPO; Office Action dated Sep. 27, 2018 in Application No. 10-2012-0076564.
KIPO; Office Action dated Mar. 27, 2019 in Application No. 10-2012-0076564.
KIPO; Office Action dated Apr. 30, 2018 in Application No. 10-2012-0103114.
KIPO; Notice of Allowance dated Nov. 22, 2018 in Application No. 10-2012-0103114.
KIPO; Office Action dated Oct. 24, 2016 in Application No. 10-2012-7004062.
KIPO; Office Action dated Jul. 24, 2017 in Application No. 10-2012-7004062.
KIPO; Office Action dated Sep. 28, 2017 in Application No. 10-2014-7017112.

(56)

References Cited

OTHER PUBLICATIONS

- KIPO; Notice of Allowance dated Feb. 23, 2018 in Application No. 10-2014-7017112.
- KIPO; Office Action dated May 30, 2019 in Application No. 10-2012-7004062.
- KIPO; Decision of Intellectual Property Trial and Appeal Board dated May 13, 2019 in Application No. 10-2012-7004062.
- KIPO; Office Action dated Apr. 19, 2019 in Application No. 10-2013-0101944.
- KIPO; Office Action dated Apr. 24, 2019 in Application No. 10-2013-0036823.
- KIPO; Office Action dated May 31, 2019 in Application No. 10-2013-0050740.
- KIPO; Office Action dated Mar. 27, 2019 in Application No. 10-2013-0084459.
- KIPO; Office Action dated Apr. 30, 2019 in Application No. 10-2013-0088450.
- KIPO; Office Action dated May 21, 2019 in Application No. 10-2013-0121554.
- KIPO; Office Action dated Jan. 22, 2019 in Application No. 10-2014-7017110.
- KIPO; Office Action dated Nov. 9, 2016 in Application No. 10-2016-7023913.
- KIPO; Notice of Allowance dated May 30, 2017 in Application No. 10-2016-7023913.
- KIPO; Notice of Allowance dated Feb. 27, 2018 in Application No. 10-2017-0175442.
- KIPO; Office Action dated Sep. 28, 2017 in Application No. 10-2017-7023740.
- KIPO; Notice of Allowance dated Jul. 19, 2018 in Application No. 20187013945.
- KIPO; Office Action dated Sep. 15, 2017 in Application No. 30-2017-0001320.
- KIPO; Notice of Allowance dated Jan. 19, 2018 in Application No. 30-2017-0001320.
- KIPO; Notice of Allowance dated Jul. 10, 2018 in Application No. 30-2017-0052872.
- KIPO; Office Action dated Jul. 11, 2018 in Application No. 30-2018-0006016.
- KIPO; Notice of Allowance dated Oct. 16, 2018 in Application No. 30-2018-0006016.
- KIPO; Office Action dated Jan. 30, 2019 in Application No. 30-2018-0033442.
- KIPO; Notice of Allowance dated Apr. 1, 2019 in Application No. 30-2018-0033442.
- TIPO; Office Action dated Aug. 30, 2013 in Application No. 97132391.
- TIPO; Office Action dated Dec. 20, 2013 in Application No. 98117513.
- TIPO; Notice of Allowance dated Jun. 12, 2014 in Application No. 98117513.
- TIPO; Office Action dated Jul. 4, 2014 in Application No. 99110511.
- TIPO; Notice of Allowance dated Feb. 24, 2016 in Application No. 99110511.
- TIPO; Office Action dated Aug. 27, 2014 in Application No. 99114329.
- TIPO; Notice of Allowance dated Jan. 28, 2015 in Application No. 99114329.
- TIPO; Office Action dated Dec. 26, 2014 in Application No. 99114330.
- TIPO; Notice of Allowance dated Apr. 28, 2015 in Application No. 99114330.
- TIPO; Office Action dated Aug. 14, 2014 in Application No. 99114331.
- TIPO; Notice of Allowance dated Oct. 16, 2015 in Application No. 99114331.
- TIPO; Office Action dated Dec. 19, 2014 in Application No. 99127063.
- TIPO; Notice of Allowance dated Mar. 14, 2016 in Application No. 99127063.
- TIPO; Notice of Allowance dated Oct. 2, 2015 in Application No. 100130472.
- TIPO; Office Action dated Feb. 19, 2016 in Application No. 100113130.
- TIPO; Notice of Allowance dated Jun. 29, 2016 in Application No. 100113130.
- TIPO; Notice of Allowance dated Nov. 2, 2016 in Application No. 101142581.
- TIPO; Office Action dated Apr. 28, 2016 in Application No. 101142582.
- TIPO; Notice of Allowance dated Aug. 19, 2016 in Application No. 101142582.
- TIPO; Office Action dated Aug. 01, 2016 in Application No. 101124745.
- TIPO; Notice of Allowance dated Oct. 19, 2016 in Application No. 101124745.
- TIPO; Office Action dated Sep. 19, 2016 in Application No. 102113028.
- TIPO; Notice of Allowance dated Feb. 13, 2017 in Application No. 102113028.
- TIPO; Office Action dated Aug. 2016 in Application No. 102115605.
- TIPO; Office Action dated Feb. 24, 2017 in Application No. 102115605.
- TIPO; Notice of Allowance dated Dec. 26, 2017 in Application No. 102115605.
- TIPO; Office Action dated Nov. 15, 2016 in Application No. 102125191.
- TIPO; Office Action dated Jun. 20, 2017 in Application No. 102125191.
- TIPO; Office Action dated Dec. 6, 2016 in Application No. 102126071.
- TIPO; Office Action dated May 17, 2018 in Application No. 102126071.
- TIPO; Notice of Allowance dated Aug. 24, 2018 in Application No. 102126071.
- TIPO; Office Action dated Feb. 10, 2017 in Application No. 102127065.
- TIPO; Notice of Allowance dated Jul. 18, 2017 in Application No. 102127065.
- TIPO; Office Action dated Nov. 3, 2016 in Application No. 102129262.
- TIPO; Notice of Allowance dated Mar. 3, 2017 in Application No. 102129262.
- TIPO; Office Action dated Dec. 29, 2016 in Application No. 102129397.
- TIPO; Notice of Allowance dated Aug. 29, 2017 in Application No. 102129397.
- TIPO; Office Action dated Nov. 3, 2016 in Application No. 102131839.
- TIPO; Notice of Allowance dated Jan. 26, 2017 in Application No. 102131839.
- TIPO; Office Action dated Dec. 2, 2016 in Application No. 102136496.
- TIPO; Office Action dated Jan. 10, 2018 in Application No. 102136496.
- TIPO; Office Action dated Nov. 11, 2016 in Application No. 102132952.
- TIPO; Notice of Allowance dated Apr. 19, 2017 in Application No. 102132952.
- TIPO; Office Action dated Jul. 17, 2017 in Application No. 103101400.
- TIPO; Notice of Allowance dated Jan. 24, 2018 in Application No. 103101400.
- TIPO; Office Action dated Feb. 23, 2017 in Application No. 103102563.
- TIPO; Notice of Allowance dated Nov. 30, 2017 in Application No. 103102563.
- TIPO; Office Action dated Mar. 3, 2017 in Application No. 103105251.
- TIPO; Notice of Allowance dated Oct. 20, 2017 in Application No. 103105251.
- TIPO; Office Action dated Nov. 1, 2017 in Application No. 103106021.
- TIPO; Notice of Allowance dated Apr. 10, 2018 in Application No. 103106021.
- TIPO; Office Action dated Oct. 31, 2017 in Application No. 103106022.
- TIPO; Notice of Allowance dated Apr. 10, 2018 in Application No. 103106022.
- TIPO; Office Action dated Jul. 5, 2017 in Application No. 103117477.
- TIPO; Notice of Allowance dated Jan. 22, 2018 in Application No. 103117477.

(56)

References Cited

OTHER PUBLICATIONS

- TIPO; Office Action dated Nov. 22, 2017 in Application No. 103117478.
TIPO; Notice of Allowance dated Mar. 13, 2018 in Application No. 103117478.
TIPO; Office Action dated May 19, 2017 in Application No. 103120478.
TIPO; Notice of Allowance dated Sep. 25, 2017 in Application No. 103120478.
TIPO; Office Action dated Sep. 20, 2018 in Application No. 103123439.
TIPO; Office Action dated Nov. 8, 2017 in Application No. 103124509.
TIPO; Notice of Allowance dated Apr. 25, 2018 in Application No. 103124509.
TIPO; Office Action dated Nov. 20, 2017 in Application No. 103127588.
TIPO; Notice of Allowance dated Jun. 19, 2018 in Application No. 103127588.
TIPO; Office Action dated Sep. 19, 2017 in Application No. 103127734.
TIPO; Notice of Allowance dated Dec. 11, 2017 in Application No. 103127734.
TIPO; Office Action dated Sep. 26, 2018 in Application No. 103132230.
TIPO; Notice of Allowance dated Jan. 30, 2019 in Application No. 103132230.
TIPO; Office Action dated Nov. 22, 2017 in Application No. 103134537.
TIPO; Notice of Allowance dated Apr. 19, 2018 in Application No. 103134537.
TIPO; Office Action dated Aug. 24, 2017 in Application No. 103136251.
TIPO; Notice of Allowance dated Oct. 17, 2017 in Application No. 103136251.
TIPO; Office Action dated Feb. 26, 2018 in Application No. 103138510.
TIPO; Notice of Allowance dated Jun. 13, 2018 in Application No. 103138510.
TIPO; Office Action dated May 21, 2018 in Application No. 103139014.
TIPO; Notice of Allowance dated Sep. 11, 2018 in Application No. 103139014.
TIPO; Office Action dated Jun. 22, 2018 in Application No. 104105533.
TIPO; Office Action dated Feb. 22, 2019 in Application No. 104105533.
TIPO; Office Action dated Nov. 19, 2018 in Application No. 104105965.
TIPO; Office Action dated Jul. 9, 2018 in Application No. 104107876.
TIPO; Notice of Allowance dated May 9, 2019 in Application No. 104107876.
TIPO; Office Action dated Aug. 7, 2018 Application No. 104107888.
TIPO; Notice of Allowance dated Apr. 26, 2019 in Application No. 104107888.
TIPO; Office Action dated May 6, 2019 in Application No. 104108277.
TIPO; Office Action dated Jul. 9, 2018 in Application No. 104110326.
TIPO; Notice of Allowance dated May 8, 2019 in Application No. 104110326.
TIPO; Office Action dated Jun. 13, 2018 in Application No. 104111910.
TIPO; Notice of Allowance dated Sep. 18, 2018 in Application No. 104111910.
TIPO; Office Action dated Apr. 29, 2019 in Application No. 104122889.
TIPO; Office Action dated Jan. 30, 2019 in Application No. 104122890.
TIPO; Office Action dated Jul. 11, 2018 in Application No. 104124377.
TIPO; Notice of Allowance dated Jun. 19, 2019 in Application No. 104124377.
TIPO; Office Action dated Jan. 7, 2019 in Application No. 104132991.
TIPO; Notice of Allowance dated Apr. 12, 2019 in Application No. 104132991.
TIPO; Office Action dated Apr. 25, 2019 in Application No. 104141679.
TIPO; Office Action dated Apr. 25, 2019 in Application No. 105101536.
TIPO; Notice of Allowance dated May 7, 2019 in Application No. 105104453.
TIPO; Notice of Allowance dated Dec. 5, 2017 in Application No. 105308015.
TIPO; Notice of Allowance dated Apr. 11, 2018 in Application No. 105308015D01.
TIPO; Office Action dated Nov. 6, 2017 in Application No. 106117181.
TIPO; Notice of Allowance dated Jun. 5, 2018 in Application No. 106117181.
TIPO; Office Action dated Sep. 28, 2018 in Application No. 106119537.
TIPO; Office Action dated Dec. 26, 2018 in Application No. 106127690.
TIPO; Office Action dated Aug. 31, 2018 in Application No. 106138119.
TIPO; Office Action dated Jun. 25, 2018 in Application No. 106138800.
TIPO; Office Action dated Jan. 7, 2019 in Application No. 106138800.
TIPO; Office Action dated Oct. 3, 2018 in Application No. 106142731.
TIPO; Office Action dated Sep. 28, 2018 in Application No. 107112951.
TIPO; Office Action dated Nov. 20, 2018 in Application No. 107118271.
TIPO; Office Action dated Jun. 4, 2019 in Application No. 107123992.
TIPO; Office Action dated May 28, 2019 in Application No. 107125586.
TIPO; Notice of Allowance dated Aug. 29, 2018 in Application No. 107300633.
TIPO; Notice of Allowance dated Feb. 21, 2019 in Application No. 107303723.
TIPO; Office Action dated May 31, 2019 in Application No. 108102146.
USPTO; Notice of Allowance dated Jul. 26, 2005 in U.S. Appl. No. 10/033,058.
USPTO; Non-Final Office Action dated Aug. 25, 2005 in U.S. Appl. No. 10/191,635.
USPTO; Final Office Action dated Apr. 25, 2006 in U.S. Appl. No. 10/191,635.
USPTO; Non-Final Office Action dated Nov. 20, 2006 in U.S. Appl. No. 10/191,635.
USPTO; Notice of Allowance dated May 21, 2007 in U.S. Appl. No. 10/191,635.
USPTO; Notice of Allowance dated Feb. 20, 2008 in U.S. Appl. No. 10/191,635.
USPTO; Non-Final Office Action dated May 13, 2003 in U.S. Appl. No. 10/222,229.
USPTO; Non-Final Office Action dated Oct. 22, 2003 in U.S. Appl. No. 10/222,229.
USPTO; Final Office Action dated Mar. 22, 2004 in U.S. Appl. No. 10/222,229.
USPTO; Advisory Action dated Oct. 7, 2004 in U.S. Appl. No. 10/222,229.
USPTO; Non-Final Office Action dated Dec. 22, 2004 in U.S. Appl. No. 10/222,229.
USPTO; Final Office Action dated Jun. 20, 2005 in U.S. Appl. No. 10/222,229.
USPTO; Advisory Action dated Nov. 16, 2005 in U.S. Appl. No. 10/222,229.
USPTO; Notice of Allowance dated Mar. 8, 2006 in U.S. Appl. No. 10/222,229.
USPTO; Non-Final Office Action dated Jan. 26, 2005 in U.S. Appl. No. 10/838,510.
USPTO; Notice of Allowance dated Jul. 12, 2005 in U.S. Appl. No. 10/838,510.
USPTO; Office Action dated Feb. 15, 2011 in U.S. Appl. No. 12/118,596.
USPTO; Notice of Allowance dated Aug. 4, 2011 in U.S. Appl. No. 12/118,596.
USPTO; Non-Final Office Action dated Apr. 28, 2010 in U.S. Appl. No. 12/121,085.

(56)

References Cited

OTHER PUBLICATIONS

- USPTO; Notice of Allowance dated Jul. 26, 2010 in U.S. Appl. No. 12/121,085.
- USPTO; Notice of Allowance dated Oct. 4, 2010 in U.S. Appl. No. 12/121,085.
- USPTO; Non-Final Office Action dated Sep. 13, 2010 in U.S. Appl. No. 12/140,809.
- USPTO; Final Office Action dated Dec. 28, 2010 in U.S. Appl. No. 12/140,809.
- USPTO; Notice of Allowance dated Mar. 17, 2011 in U.S. Appl. No. 12/140,809.
- USPTO; Non-Final Office Action dated Mar. 15, 2011 in U.S. Appl. No. 12/193,924.
- USPTO; Foma; Office Action dated Sep. 30, 2011 in U.S. Appl. No. 12/193,924.
- USPTO; Non-Final Office Action dated Oct. 24, 2012 in U.S. Appl. No. 12/193,924.
- USPTO; Final Office Action dated Apr. 17, 2013 in U.S. Appl. No. 12/193,924.
- USPTO; Advisory Action dated Jul. 9, 2013 in U.S. Appl. No. 12/193,924.
- USPTO; Non-Final Office Action dated Jul. 28, 2011 in U.S. Appl. No. 12/330,096.
- USPTO; Final Office Action dated Jan. 13, 2012 in U.S. Appl. No. 12/330,096.
- USPTO; Notice of Allowance dated Mar. 6, 2012 in U.S. Appl. No. 12/330,096.
- USPTO; Non-Final Office Action dated Mar. 20, 2012 in U.S. Appl. No. 12/330,096.
- USPTO; Notice of Allowance dated Jun. 7, 2012 in U.S. Appl. No. 12/330,096.
- USPTO; Non-Final Office Action dated Apr. 1, 2010 in U.S. Appl. No. 12/357,174.
- USPTO; Final Office Action dated Sep. 1, 2010 in U.S. Appl. No. 12/357,174.
- USPTO; Notice of Allowance dated Dec. 13, 2010 in U.S. Appl. No. 12/357,174.
- USPTO; Non-Final Office Action dated Dec. 29, 2010 in U.S. Appl. No. 12/362,023.
- USPTO; Non-Final Office Action dated Jul. 26, 2011 in U.S. Appl. No. 12/416,809.
- USPTO; Final Office Action dated Dec. 6, 2011 in U.S. Appl. No. 12/416,809.
- USPTO; Notice of Allowance dated Apr. 2, 2012 in U.S. Appl. No. 12/416,809.
- USPTO; Advisory Action dated Feb. 3, 2012 in U.S. Appl. No. 12/416,809.
- USPTO; Notice of Allowance dated Jun. 16, 2011 in U.S. Appl. No. 12/430,751.
- USPTO; Notice of Allowance dated Jul. 27, 2011 in U.S. Appl. No. 12/430,751.
- USPTO; Non-Final Office Action dated Aug. 3, 2011 in U.S. Appl. No. 12/436,300.
- USPTO; Final Office Action dated Jan. 23, 2012 in U.S. Appl. No. 12/436,300.
- USPTO; Advisory Action dated Mar. 6, 2012 in U.S. Appl. No. 12/436,300.
- USPTO; Non-Final Office Action dated May 22, 2012 in U.S. Appl. No. 12/436,300.
- USPTO; Notice of Allowance dated Nov. 28, 2012 in U.S. Appl. No. 12/436,300.
- USPTO; Non-Final Office Action dated Apr. 11, 2012 in U.S. Appl. No. 12/436,306.
- USPTO; Final Office Action dated Sep. 26, 2012 in U.S. Appl. No. 12/436,306.
- USPTO; Non-Final Office Action dated May 31, 2013 in U.S. Appl. No. 12/436,306.
- USPTO; Final Office Action dated Oct. 17, 2013 in U.S. Appl. No. 12/436,306.
- USPTO; Non-Final Office Action dated Feb. 4, 2014 in U.S. Appl. No. 12/436,306.
- USPTO; Final Office Action dated Jun. 23, 2014 in U.S. Appl. No. 12/436,306.
- USPTO; Advisory Action dated Oct. 1, 2014 in U.S. Appl. No. 12/436,306.
- USPTO; Non-Final Office Action dated Feb. 3, 2015 in U.S. Appl. No. 12/436,306.
- USPTO; Final Office Action dated May 13, 2015 in U.S. Appl. No. 12/436,306.
- USPTO; Non-Final Office Action dated Oct. 14, 2015 in U.S. Appl. No. 12/436,306.
- USPTO; Final Office Action dated Dec. 31, 2015 in U.S. Appl. No. 12/436,306.
- USPTO; Notice of Allowance dated Feb. 3, 2016 in U.S. Appl. No. 12/436,306.
- USPTO; Non-Final Office Action dated Aug. 3, 2011 in U.S. Appl. No. 12/436,315.
- USPTO; Notice of Allowance dated Nov. 17, 2011 in U.S. Appl. No. 12/436,315.
- USPTO; Notice of Allowance dated Oct. 1, 2010 in U.S. Appl. No. 12/467,017.
- USPTO; Non-Final Office Action dated Mar. 18, 2010 in U.S. Appl. No. 12/489,252.
- USPTO; Notice of Allowance dated Sep. 2, 2010 in U.S. Appl. No. 12/489,252.
- USPTO; Non-Final Office Action dated Dec. 15, 2010 in U.S. Appl. No. 12/553,759.
- USPTO; Final Office Action dated May 4, 2011 in U.S. Appl. No. 12/553,759.
- USPTO; Advisory Action dated Jul. 13, 2011 in U.S. Appl. No. 12/553,759.
- USPTO; Non-Final Office Action dated Sep. 6, 2011 in U.S. Appl. No. 12/553,759.
- USPTO; Notice of Allowance dated Jan. 27, 2012 in U.S. Appl. No. 12/553,759.
- USPTO; Non-Final Office Action dated Oct. 19, 2012 in U.S. Appl. No. 12/618,355.
- USPTO; Final Office Action dated May 8, 2013 in U.S. Appl. No. 12/618,355.
- USPTO; Advisory Action dated Jul. 23, 2013 in U.S. Appl. No. 12/618,355.
- USPTO; Non-Final Office Action dated Apr. 8, 2015 in U.S. Appl. No. 12/618,355.
- USPTO; Final Office Action dated Oct. 22, 2015 in U.S. Appl. No. 12/618,355.
- USPTO; Advisory Action dated Mar. 4, 2016 in U.S. Appl. No. 12/618,355.
- USPTO; Non-Final Office Action dated Jun. 30, 2016 in U.S. Appl. No. 12/618,355.
- USPTO; Final Office Action dated Feb. 10, 2017 in U.S. Appl. No. 12/618,355.
- USPTO; Advisory Action dated May 16, 2017 in U.S. Appl. No. 12/618,355.
- USPTO; Non-Final Office Action dated Nov. 29, 2017 in U.S. Appl. No. 12/618,355.
- USPTO; Final Office Action dated Aug. 10, 2018 in U.S. Appl. No. 12/618,355.
- USPTO; Notice of Allowance dated Apr. 4, 2019 in U.S. Appl. No. 12/618,355.
- USPTO; Non-Final Office Action dated Feb. 16, 2012 in U.S. Appl. No. 12/618,419.
- USPTO; Final Office Action dated Jun. 22, 2012 in U.S. Appl. No. 12/618,419.
- USPTO; Non-Final Office Action dated Nov. 27, 2012 in U.S. Appl. No. 12/618,419.
- USPTO; Advisory Action dated Aug. 9, 2012 in U.S. Appl. No. 12/618,419.
- USPTO; Notice of Allowance dated Apr. 12, 2013 in U.S. Appl. No. 12/618,419.
- USPTO; Non-Final Office Action dated Jun. 12, 2013 in U.S. Appl. No. 12/618,419.

(56)

References Cited

OTHER PUBLICATIONS

- USPTO; Notice of Allowance dated Oct. 9, 2013 in U.S. Appl. No. 12/618,419.
- USPTO; Non-Final Office Action dated Dec. 6, 2011 in U.S. Appl. No. 12/718,731.
- USPTO; Notice of Allowance dated Mar. 16, 2012 in U.S. Appl. No. 12/718,731.
- USPTO; Office Action dated Feb. 26, 2013 in U.S. Appl. No. 12/754,223.
- USPTO; Final Office Action dated Jun. 28, 2013 in U.S. Appl. No. 12/754,223.
- USPTO; Office Action dated Feb. 25, 2014 in U.S. Appl. No. 12/754,223.
- USPTO; Final Office Action dated Jul. 14, 2014 in U.S. Appl. No. 12/754,223.
- USPTO; Non-Final Office Action dated Mar. 25, 2015 in U.S. Appl. No. 12/754,223.
- USPTO; Final Office Action dated Aug. 12, 2015 in U.S. Appl. No. 12/754,223.
- USPTO; Notice of Allowance dated May 23, 2016 in U.S. Appl. No. 12/754,223.
- USPTO; Office Action dated Apr. 23, 2013 in U.S. Appl. No. 12/763,037.
- USPTO; Final Office Action dated Oct. 21, 2013 in U.S. Appl. No. 12/763,037.
- USPTO; Office Action dated Oct. 8, 2014 in U.S. Appl. No. 12/763,037.
- USPTO; Notice of Allowance dated Jan. 27, 2015 in U.S. Appl. No. 12/763,037.
- USPTO; Non-Final Office Action dated Jan. 24, 2011 in U.S. Appl. No. 12/778,808.
- USPTO; Notice of Allowance dated May 9, 2011 in U.S. Appl. No. 12/778,808.
- USPTO; Notice of Allowance dated Oct. 12, 2012 in U.S. Appl. No. 12/832,739.
- USPTO; Non-Final Office Action dated Oct. 16, 2012 in U.S. Appl. No. 12/847,848.
- USPTO; Final Office Action dated Apr. 22, 2013 in U.S. Appl. No. 12/847,848.
- USPTO; Advisory Action dated Jul. 1, 2013 in U.S. Appl. No. 12/847,848.
- USPTO; Notice of Allowance dated Jan. 16, 2014 in U.S. Appl. No. 12/847,848.
- USPTO; Office Action dated Dec. 6, 2012 in U.S. Appl. No. 12/854,818.
- USPTO; Final Office Action dated Mar. 13, 2013 in U.S. Appl. No. 12/854,818.
- USPTO; Office Action dated Aug. 30, 2013 in U.S. Appl. No. 12/854,818.
- USPTO; Final Office Action dated Mar. 26, 2014 in U.S. Appl. No. 12/854,818.
- USPTO; Office Action dated Jun. 3, 2014 in U.S. Appl. No. 12/854,818.
- USPTO; Non-Final Office Action dated Jul. 11, 2012 in U.S. Appl. No. 12/875,889.
- USPTO; Notice of Allowance dated Jan. 4, 2013 in U.S. Appl. No. 12/875,889.
- USPTO; Notice of Allowance dated Jan. 9, 2012 in U.S. Appl. No. 12/901,323.
- USPTO; Non-Final Office Action dated Nov. 20, 2013 in U.S. Appl. No. 12/910,607.
- USPTO; Final Office Action dated Apr. 28, 2014 in U.S. Appl. No. 12/910,607.
- USPTO; Advisory Action dated Jul. 9, 2014 in U.S. Appl. No. 12/910,607.
- USPTO; Notice of Allowance dated Aug. 15, 2014 in U.S. Appl. No. 12/910,607.
- USPTO; Non-Final Office Action dated Oct. 24, 2012 in U.S. Appl. No. 12/940,906.
- USPTO; Final Office Action dated Feb. 13, 2013 in U.S. Appl. No. 12/940,906.
- USPTO; Notice of Allowance dated Apr. 23, 2013 in U.S. Appl. No. 12/940,906.
- USPTO; Non-Final Office Action dated Dec. 7, 2012 in U.S. Appl. No. 12/953,870.
- USPTO; Final Office Action dated Apr. 22, 2013 in U.S. Appl. No. 12/953,870.
- USPTO; Advisory Action dated Jul. 8, 2013 in U.S. Appl. No. 12/953,870.
- USPTO; Non-Final Office Action dated Aug. 28, 2013 in U.S. Appl. No. 12/953,870.
- USPTO; Final Office Action dated Apr. 17, 2014 in U.S. Appl. No. 12/953,870.
- USPTO; Non-Final Office Action dated Sep. 19, 2012 in U.S. Appl. No. 13/016,735.
- USPTO; Final Office Action dated Feb. 11, 2013 in U.S. Appl. No. 13/016,735.
- USPTO; Notice of Allowance dated Apr. 24, 2013 in U.S. Appl. No. 13/016,735.
- USPTO; Non-Final Office Action dated Apr. 4, 2012 in U.S. Appl. No. 13/030,438.
- USPTO; Final Office Action dated Aug. 22, 2012 in U.S. Appl. No. 13/030,438.
- USPTO; Notice of Allowance dated Oct. 24, 2012 in U.S. Appl. No. 13/030,438.
- USPTO; Non-Final Office Action dated Dec. 3, 2012 in U.S. Appl. No. 13/040,013.
- USPTO; Notice of Allowance dated May 3, 2013 in U.S. Appl. No. 13/040,013.
- USPTO; Non-Final Office Action dated Feb. 15, 2012 in U.S. Appl. No. 13/085,531.
- USPTO; Notice of Allowance dated Jul. 12, 2012 in U.S. Appl. No. 13/085,531.
- USPTO; Notice of Allowance dated Sep. 13, 2012 in U.S. Appl. No. 13/085,698.
- USPTO; Non-Final Office Action dated Mar. 29, 2013 in U.S. Appl. No. 13/094,402.
- USPTO; Final Office Action dated Jul. 17, 2013 in U.S. Appl. No. 13/094,402.
- USPTO; Notice of Allowance dated Sep. 30, 2013 in U.S. Appl. No. 13/094,402.
- USPTO; Office Action dated Oct. 7, 2013 in U.S. Appl. No. 13/102,980.
- USPTO; Final Office Action dated Mar. 25, 2014 in U.S. Appl. No. 13/102,980.
- USPTO; Advisory Action dated Jun. 12, 2014 in U.S. Appl. No. 13/102,980.
- USPTO; Notice of Allowance dated Jul. 3, 2014 in U.S. Appl. No. 13/102,980.
- USPTO; Notice of Allowance dated Sep. 17, 2014 in U.S. Appl. No. 13/102,980.
- USPTO; Non-Final Office Action dated Jul. 17, 2014 in U.S. Appl. No. 13/154,271.
- USPTO; Final Office Action dated Jan. 2, 2015 in U.S. Appl. No. 13/154,271.
- USPTO; Non-Final Office Action dated May 27, 2015 in U.S. Appl. No. 13/154,271.
- USPTO; Final Office Action dated Nov. 23, 2015 in U.S. Appl. No. 13/154,271.
- USPTO; Notice of Allowance dated Feb. 10, 2016 in U.S. Appl. No. 13/154,271.
- USPTO; Non-Final Office Action dated Jun. 27, 2016 in U.S. Appl. No. 13/166,367.
- USPTO; Final Office Action dated Dec. 30, 2016 in U.S. Appl. No. 13/166,367.
- USPTO; Advisory Action dated Apr. 21, 2017 in U.S. Appl. No. 13/166,367.
- USPTO; Notice of Allowance dated Jun. 28, 2017 in U.S. Appl. No. 13/166,367.
- USPTO; Non-Final Office Action dated Oct. 27, 2014 in U.S. Appl. No. 13/169,951.

(56)

References Cited

OTHER PUBLICATIONS

- USPTO; Final Office Action dated May 26, 2015 in U.S. Appl. No. 13/169,951.
- USPTO; Non-Final Office Action dated Sep. 1, 2015 in U.S. Appl. No. 13/169,951.
- USPTO; Final Office Action dated Mar. 3, 2016 in U.S. Appl. No. 13/169,951.
- USPTO; Non-Final Office Action dated Jun. 9, 2016 in U.S. Appl. No. 13/169,951.
- USPTO; Final Office Action dated Dec. 9, 2016 in U.S. Appl. No. 13/169,951.
- USPTO; Advisory Action dated May 13, 2016 in U.S. Appl. No. 13/169,951.
- USPTO; Advisory Action dated Feb. 15, 2017 in U.S. Appl. No. 13/169,951.
- USPTO; Non-Final Office Action dated Apr. 26, 2017 in U.S. Appl. No. 13/169,951.
- USPTO; Final Office Action dated Nov. 2, 2017 in U.S. Appl. No. 13/169,951.
- USPTO; Advisory Action dated Feb. 8, 2018 in U.S. Appl. No. 13/169,951.
- USPTO; Non-Final Office Action dated Apr. 6, 2018 in U.S. Appl. No. 13/169,951.
- USPTO; Final Office Action dated Nov. 2, 2018 in U.S. Appl. No. 13/169,951.
- USPTO; Advisory Action dated Feb. 4, 2019 in U.S. Appl. No. 13/169,951.
- USPTO; Notice of Allowance dated Apr. 4, 2019 in U.S. Appl. No. 13/169,951.
- USPTO; Non-Final Office Action dated Jun. 24, 2014 in U.S. Appl. No. 13/181,407.
- USPTO; Final Office Action dated Sep. 24, 2014 in U.S. Appl. No. 13/181,407.
- USPTO; Advisory Action dated Dec. 17, 2014 in U.S. Appl. No. 13/181,407.
- USPTO; Non-Final Office Action dated Jan. 2, 2015 in U.S. Appl. No. 13/181,407.
- USPTO; Final Office Action dated Apr. 8, 2015 in U.S. Appl. No. 13/181,407.
- USPTO; Non-Final Office Action dated Jan. 23, 2013 in U.S. Appl. No. 13/184,351.
- USPTO; Final Office Action dated Jul. 29, 2013 in U.S. Appl. No. 13/184,351.
- USPTO; Advisory Action dated Nov. 7, 2013 in U.S. Appl. No. 13/184,351.
- USPTO; Non-Final Office Action dated Jul. 16, 2014 in U.S. Appl. No. 13/184,351.
- USPTO; Final Office Action dated Feb. 17, 2015 in U.S. Appl. No. 13/184,351.
- USPTO; Advisory Action dated May 18, 2015 in U.S. Appl. No. 13/184,351.
- USPTO; Non-Final Office Action dated Aug. 10, 2015 in U.S. Appl. No. 13/184,351.
- USPTO; Final Office Action dated Feb. 12, 2016 in U.S. Appl. No. 13/184,351.
- USPTO; Non-Final Office Action dated Dec. 15, 2016 in U.S. Appl. No. 13/184,351.
- USPTO; Final Office Action dated Jun. 15, 2017 in U.S. Appl. No. 13/184,351.
- USPTO; Advisory Action dated Oct. 4, 2017 in U.S. Appl. No. 13/184,351.
- USPTO; Non-Final Office Action dated Jul. 26, 2018 in U.S. Appl. No. 13/184,351.
- USPTO; Final Office Action dated Dec. 28, 2018 in U.S. Appl. No. 13/184,351.
- USPTO; Non-Final Office Action dated Sep. 17, 2014 in U.S. Appl. No. 13/187,300.
- USPTO; Final Office Action dated Apr. 15, 2015 in U.S. Appl. No. 13/187,300.
- USPTO; Non-Final Office Action dated Apr. 7, 2016 in U.S. Appl. No. 13/187,300.
- USPTO; Final Office Action dated Sep. 23, 2016 in U.S. Appl. No. 13/187,300.
- USPTO; Non-Final Office Action dated Jan. 30, 2017 in U.S. Appl. No. 13/187,300.
- USPTO; Final Office Action dated Aug. 9, 2017 in U.S. Appl. No. 13/187,300.
- USPTO; Non-Final Office Action dated Oct. 1, 2012 in U.S. Appl. No. 13/191,762.
- USPTO; Final Office Action dated Apr. 10, 2013 in U.S. Appl. No. 13/191,762.
- USPTO; Notice of Allowance dated Aug. 15, 2013 in U.S. Appl. No. 13/191,762.
- USPTO; Non-Final Office Action dated Oct. 22, 2012 in U.S. Appl. No. 13/238,960.
- USPTO; Final Office Action dated May 3, 2013 in U.S. Appl. No. 13/238,960.
- USPTO; Non-Final Office Action dated Apr. 26, 2013 in U.S. Appl. No. 13/250,721.
- USPTO; Notice of Allowance dated Sep. 11, 2013 in U.S. Appl. No. 13/250,721.
- USPTO; Non-Final Office Action dated Jul. 2, 2014 in U.S. Appl. No. 13/283,408.
- USPTO; Final Office Action dated Jan. 29, 2015 in U.S. Appl. No. 13/283,408.
- USPTO; Non-Final Office Action dated Jun. 17, 2015 in U.S. Appl. No. 13/283,408.
- USPTO; Final Office Action dated Dec. 18, 2015 in U.S. Appl. No. 13/283,408.
- USPTO; Advisory Action dated Mar. 28, 2016 in U.S. Appl. No. 13/283,408.
- USPTO; Notice of Allowance dated Mar. 28, 2016 in U.S. Appl. No. 13/283,408.
- USPTO; Office Action dated Jul. 30, 2014 in U.S. Appl. No. 13/284,642.
- USPTO; Notice of Allowance dated Feb. 11, 2015 in U.S. Appl. No. 13/284,642.
- USPTO; Office Action dated Jan. 28, 2014 in U.S. Appl. No. 13/312,591.
- USPTO; Final Office Action dated May 14, 2014 in U.S. Appl. No. 13/312,591.
- USPTO; Advisory Action dated Aug. 26, 2014 in U.S. Appl. No. 13/312,591.
- USPTO; Non-Final Office Action dated Nov. 26, 2014 in U.S. Appl. No. 13/312,591.
- USPTO; Final Office Action dated Mar. 20, 2015 in U.S. Appl. No. 13/312,591.
- USPTO; Notice of Allowance dated May 14, 2015 in U.S. Appl. No. 13/312,591.
- USPTO; Notice of Allowance dated Jun. 11, 2015 in U.S. Appl. No. 13/312,591.
- USPTO; Non-Final Office Action dated Apr. 9, 2014 in U.S. Appl. No. 13/333,420.
- USPTO; Notice of Allowance dated Sep. 15, 2014 in U.S. Appl. No. 13/333,420.
- USPTO; Office Action dated Feb. 11, 2013 in U.S. Appl. No. 13/339,609.
- USPTO; Final Office Action dated May 17, 2013 in U.S. Appl. No. 13/339,609.
- USPTO; Office Action dated Aug. 29, 2013 in U.S. Appl. No. 13/339,609.
- USPTO; Final Office Action dated Dec. 18, 2013 in U.S. Appl. No. 13/339,609.
- USPTO; Notice of Allowance dated Apr. 7, 2014 in U.S. Appl. No. 13/339,609.
- USPTO; Non-Final Office Action dated Oct. 10, 2012 in U.S. Appl. No. 13/406,791.
- USPTO; Final Office Action dated Jan. 31, 2013 in U.S. Appl. No. 13/406,791.
- USPTO; Advisory Action dated Mar. 27, 2013 in U.S. Appl. No. 13/406,791.

(56)

References Cited

OTHER PUBLICATIONS

- USPTO; Non-Final Office Action dated Apr. 25, 2013 in U.S. Appl. No. 13/406,791.
- USPTO; Final Office Action dated Aug. 23, 2013 in U.S. Appl. No. 13/406,791.
- USPTO; Advisory Action dated Oct. 29, 2013 in U.S. Appl. No. 13/406,791.
- USPTO; Non-Final Office Action dated Dec. 4, 2013 in U.S. Appl. No. 13/406,791.
- USPTO; Final Office Action dated Apr. 21, 2014 in U.S. Appl. No. 13/406,791.
- USPTO; Non-Final Office Action dated Jan. 14, 2013 in U.S. Appl. No. 13/410,970.
- USPTO; Notice of Allowance dated Feb. 14, 2013 in U.S. Appl. No. 13/410,970.
- USPTO; Non-Final Office Action dated Feb. 13, 2014 in U.S. Appl. No. 13/411,271.
- USPTO; Non-Final Office Action dated Jul. 31, 2014 in U.S. Appl. No. 13/411,271.
- USPTO; Advisory Action dated Apr. 22, 2015 in U.S. Appl. No. 13/411,271.
- USPTO; Final Office Action dated Jan. 16, 2015 in U.S. Appl. No. 13/411,271.
- USPTO; Notice of Allowance dated Oct. 6, 2015 in U.S. Appl. No. 13/411,271.
- USPTO; Office Action dated Feb. 4, 2014 in U.S. Appl. No. 13/439,528.
- USPTO; Final Office Action dated Jul. 8, 2014 in U.S. Appl. No. 13/439,528.
- USPTO; Notice of Allowance dated Oct. 21, 2014 in U.S. Appl. No. 13/439,528.
- USPTO; Non-Final Office Action dated Apr. 11, 2013 in U.S. Appl. No. 13/450,368.
- USPTO; Notice of Allowance dated Jul. 17, 2013 in U.S. Appl. No. 13/450,368.
- USPTO; Office Action dated May 23, 2013 in U.S. Appl. No. 13/465,340.
- USPTO; Final Office Action dated Oct. 30, 2013 in U.S. Appl. No. 13/465,340.
- USPTO; Notice of Allowance dated Feb. 12, 2014 in U.S. Appl. No. 13/465,340.
- USPTO; Non-Final Office Action dated Oct. 17, 2013 in U.S. Appl. No. 13/493,897.
- USPTO; Notice of Allowance dated Mar. 20, 2014 in U.S. Appl. No. 13/493,897.
- USPTO; Office Action dated Dec. 20, 2013 in U.S. Appl. No. 13/535,214.
- USPTO; Final Office Action dated Jun. 18, 2014 in U.S. Appl. No. 13/535,214.
- USPTO; Notice of Allowance dated Oct. 23, 2014 in U.S. Appl. No. 13/535,214.
- USPTO; Non-Final Office Action dated Sep. 11, 2013 in U.S. Appl. No. 13/550,419.
- USPTO; Final Office Action dated Jan. 27, 2014 in U.S. Appl. No. 13/550,419.
- USPTO; Advisory Action dated Mar. 31, 2014 in U.S. Appl. No. 13/550,419.
- USPTO; Notice of Allowance dated May 29, 2014 in U.S. Appl. No. 13/550,419.
- USPTO; Non-Final Office Action dated Aug. 8, 2014 in U.S. Appl. No. 13/563,066.
- USPTO; Final Office Action dated Feb. 12, 2015 in U.S. Appl. No. 13/563,066.
- USPTO; Advisory Action dated Apr. 16, 2015 in U.S. Appl. No. 13/563,066.
- USPTO; Notice of Allowance dated Jun. 12, 2015 in U.S. Appl. No. 13/563,066.
- USPTO; Notice of Allowance dated Jul. 16, 2015 in U.S. Appl. No. 13/563,066.
- USPTO; Non-Final Office Action dated May 28, 2013 in U.S. Appl. No. 13/563,274.
- USPTO; Notice of Allowance dated Sep. 27, 2013 in U.S. Appl. No. 13/563,274.
- USPTO; Non-Final Office Action dated Nov. 7, 2013 in U.S. Appl. No. 13/565,564.
- USPTO; Final Office Action dated Feb. 28, 2014 in U.S. Appl. No. 13/565,564.
- USPTO; Advisory Action dated May 5, 2014 in U.S. Appl. No. 13/565,564.
- USPTO; Non-Final Office Action dated Jul. 2, 2014 in U.S. Appl. No. 13/565,564.
- USPTO; Notice of Allowance dated Nov. 3, 2014 in U.S. Appl. No. 13/565,564.
- USPTO; Notice of Allowance dated Sep. 13, 2013 in U.S. Appl. No. 13/566,069.
- USPTO; Non-Final Office Action dated Aug. 30, 2013 in U.S. Appl. No. 13/570,067.
- USPTO; Notice of Allowance dated Jan. 6, 2014 in U.S. Appl. No. 13/570,067.
- USPTO; Non-Final Office Action dated Oct. 15, 2014 in U.S. Appl. No. 13/597,043.
- USPTO; Final Office Action dated Mar. 13, 2015 in U.S. Appl. No. 13/597,043.
- USPTO; Notice of Allowance dated Aug. 28, 2015 in U.S. Appl. No. 13/597,043.
- USPTO; Non-Final Office Action dated Feb. 12, 2015 in U.S. Appl. No. 13/597,108.
- USPTO; Final Office Action dated Jun. 1, 2015 in U.S. Appl. No. 13/597,108.
- USPTO; Advisory Action dated Sep. 2, 2015 in U.S. Appl. No. 13/597,108.
- USPTO; Non-Final Office Action dated Dec. 8, 2015 in U.S. Appl. No. 13/597,108.
- USPTO; Final Office Action dated Jun. 2, 2016 in U.S. Appl. No. 13/597,108.
- USPTO; Non-Final Office Action dated Sep. 15, 2016 in U.S. Appl. No. 13/597,108.
- USPTO; Notice of Allowance dated Mar. 7, 2017 in U.S. Appl. No. 13/597,108.
- USPTO; Notice of Allowance dated Mar. 27, 2014 in U.S. Appl. No. 13/604,498.
- USPTO; Office Action dated Nov. 15, 2013 in U.S. Appl. No. 13/612,538.
- USPTO; Office Action dated Jul. 10, 2014 in U.S. Appl. No. 13/612,538.
- USPTO; Notice of Allowance dated Feb. 25, 2015 in U.S. Appl. No. 13/612,538.
- USPTO; Non-Final Office Action dated Apr. 15, 2015 in U.S. Appl. No. 13/646,403.
- USPTO; Final Office Action dated Oct. 15, 2015 in U.S. Appl. No. 13/646,403.
- USPTO; Notice of Allowance dated Feb. 2, 2016 in U.S. Appl. No. 13/646,403.
- USPTO; Non-Final Office Action dated May 15, 2014 in U.S. Appl. No. 13/646,471.
- USPTO; Final Office Action dated Aug. 18, 2014 in U.S. Appl. No. 13/646,471.
- USPTO; Advisory Action dated Nov. 14, 2014 in U.S. Appl. No. 13/646,471.
- USPTO; Non-Final Office Action dated Dec. 16, 2014 in U.S. Appl. No. 13/646,471.
- USPTO; Final Office Action dated Apr. 21, 2015 in U.S. Appl. No. 13/646,471.
- USPTO; Non-Final Office Action dated Aug. 19, 2015 in U.S. Appl. No. 13/646,471.
- USPTO; Final Office Action dated Jan. 22, 2016 in U.S. Appl. No. 13/646,471.
- USPTO; Advisory Action dated Apr. 15, 2016 in U.S. Appl. No. 13/646,471.
- USPTO; Non-Final Office Action dated Jun. 2, 2016 in U.S. Appl. No. 13/646,471.

(56)

References Cited

OTHER PUBLICATIONS

- USPTO; Final Office Action dated Oct. 20, 2016 in U.S. Appl. No. 13/646,471.
- USPTO; Non-Final Office Action dated May 28, 2015 in U.S. Appl. No. 13/651,144.
- USPTO; Final Office Action dated Dec. 14, 2017 in U.S. Appl. No. 13/651,144.
- USPTO; Final Office Action dated Nov. 19, 2015 in U.S. Appl. No. 13/651,144.
- USPTO; Non-Final Office Action dated May 10, 2016 in U.S. Appl. No. 13/651,144.
- USPTO; Final Office Action dated Sep. 20, 2016 in U.S. Appl. No. 13/651,144.
- USPTO; Non-Final Office Action dated May 17, 2017 in U.S. Appl. No. 13/651,144.
- USPTO; Non-Final Office Action dated Dec. 14, 2017 in U.S. Appl. No. 13/651,144.
- USPTO; Advisory Action dated Apr. 19, 2018 in U.S. Appl. No. 13/651,144.
- USPTO; Non-Final Office Action dated Sep. 20, 2018 in U.S. Appl. No. 13/651,144.
- USPTO; Final Office Action dated Mar. 15, 2019 in U.S. Appl. No. 13/651,144.
- USPTO; Non-Final Office Action dated Nov. 19, 2015 in U.S. Appl. No. 14/659,437.
- USPTO; Final Office Action dated Mar. 17, 2016 in U.S. Appl. No. 14/659,437.
- USPTO; Notice of Allowance dated May 31, 2016 in U.S. Appl. No. 14/659,437.
- USPTO; Non-Final Office Action dated Jun. 18, 2015 in U.S. Appl. No. 13/665,366.
- USPTO; Final Office Action dated Mar. 1, 2016 in U.S. Appl. No. 13/665,366.
- USPTO; Advisory Action dated May 13, 2016 in U.S. Appl. No. 13/665,366.
- USPTO; Non-Final Office Action dated Jun. 17, 2016 in U.S. Appl. No. 13/665,366.
- USPTO; Final Office Action dated May 3, 2017 in U.S. Appl. No. 13/665,366.
- USPTO; Non-Final Office Action dated Apr. 3, 2015 in U.S. Appl. No. 13/677,133.
- USPTO; Notice of Allowance dated Aug. 4, 2015 in U.S. Appl. No. 13/677,133.
- USPTO; Notice of Allowance dated Aug. 24, 2015 in U.S. Appl. No. 13/677,133.
- USPTO; Office Action dated Jun. 2, 2014 in U.S. Appl. No. 13/677,151.
- USPTO; Final Office Action dated Nov. 14, 2014 in U.S. Appl. No. 13/677,151.
- USPTO; Notice of Allowance dated Feb. 26, 2015 in U.S. Appl. No. 13/677,151.
- USPTO; Notice of Allowance dated Mar. 17, 2015 in U.S. Appl. No. 13/677,151.
- USPTO; Non-Final Office Action dated Aug. 20, 2013 in U.S. Appl. No. 13/679,502.
- USPTO; Final Office Action dated Feb. 25, 2014 in U.S. Appl. No. 13/679,502.
- USPTO; Notice of Allowance dated May 2, 2014 in U.S. Appl. No. 13/679,502.
- USPTO; Non-Final Office Action dated Jul. 21, 2015 in U.S. Appl. No. 13/727,324.
- USPTO; Final Office Action dated Jan. 22, 2016 in U.S. Appl. No. 13/727,324.
- USPTO; Advisory Action dated Apr. 6, 2016 in U.S. Appl. No. 13/727,324.
- USPTO; Non-Final Office Action dated May 25, 2016 in U.S. Appl. No. 13/727,324.
- USPTO; Final Office Action dated Dec. 1, 2016 in U.S. Appl. No. 13/727,324.
- USPTO; Notice of Allowance dated Mar. 1, 2017 in U.S. Appl. No. 13/727,324.
- USPTO; Non-Final Office Action dated Oct. 24, 2013 in U.S. Appl. No. 13/749,878.
- USPTO; Non-Final Office Action dated Jun. 18, 2014 in U.S. Appl. No. 13/749,878.
- USPTO; Final Office Action dated Dec. 10, 2014 in U.S. Appl. No. 13/749,878.
- USPTO; Notice of Allowance Mar. 13, 2015 dated in U.S. Appl. No. 13/749,878.
- USPTO; Non-Final Office Action dated Sep. 16, 2013 in U.S. Appl. No. 13/760,160.
- USPTO; Final Office Action dated Dec. 27, 2013 in U.S. Appl. No. 13/760,160.
- USPTO; Non-Final Office Action dated Jun. 4, 2014 in U.S. Appl. No. 13/760,160.
- USPTO; Final Office Action dated Sep. 25, 2014 in U.S. Appl. No. 13/760,160.
- USPTO; Final Office Action dated Jan. 28, 2015 in U.S. Appl. No. 13/760,160.
- USPTO; Final Office Action dated May 12, 2015 in U.S. Appl. No. 13/760,160.
- USPTO; Notice of Allowance dated Oct. 21, 2015 in U.S. Appl. No. 13/760,160.
- USPTO; Notice of Allowance dated Jan. 20, 2016 in U.S. Appl. No. 13/760,160.
- USPTO; Office Action dated Apr. 23, 2014 in U.S. Appl. No. 13/784,362.
- USPTO; Notice of Allowance dated Aug. 13, 2014 in U.S. Appl. No. 13/784,362.
- USPTO; Non-Final Office Action dated Dec. 19, 2013 in U.S. Appl. No. 13/784,388.
- USPTO; Notice of Allowance dated Jun. 4, 2014 in U.S. Appl. No. 13/784,388.
- USPTO; Non-Final Office Action dated Sep. 19, 2014 in U.S. Appl. No. 13/791,246.
- USPTO; Final Office Action dated Mar. 25, 2015 in U.S. Appl. No. 13/791,246.
- USPTO; Non-Final Office Action dated Oct. 26, 2015 in U.S. Appl. No. 13/791,246.
- USPTO; Final Office Action dated Apr. 20, 2016 in U.S. Appl. No. 13/791,246.
- USPTO; Advisory Action dated Jul. 13, 2016 in U.S. Appl. No. 13/791,246.
- USPTO; Non-Final Office Action dated Aug. 11, 2016 in U.S. Appl. No. 13/791,246.
- USPTO; Notice of Allowance dated Oct. 19, 2016 in U.S. Appl. No. 13/791,246.
- USPTO; Notice of Allowance dated Nov. 25, 2016 in U.S. Appl. No. 13/791,246.
- USPTO; Non-Final Office Action dated Nov. 6, 2015 in U.S. Appl. No. 13/791,339.
- USPTO; Final Office Action dated Apr. 12, 2016 in U.S. Appl. No. 13/791,339.
- USPTO; Advisory Action dated Jul. 14, 2016 in U.S. Appl. No. 13/791,339.
- USPTO; Notice of Allowance dated Aug. 24, 2016 in U.S. Appl. No. 13/791,339.
- USPTO; Non-Final Office Action dated Mar. 21, 2014 in U.S. Appl. No. 13/799,708.
- USPTO; Notice of Allowance dated Oct. 31, 2014 in U.S. Appl. No. 13/799,708.
- USPTO; Non-Final Office Action dated Sep. 1, 2016 in U.S. Appl. No. 14/827,177.
- USPTO; Non-Final Office Action dated Oct. 9, 2014 in U.S. Appl. No. 13/874,708.
- USPTO; Notice of Allowance dated Mar. 10, 2015 in U.S. Appl. No. 13/874,708.
- USPTO; Notice of Allowance dated Apr. 10, 2014 in U.S. Appl. No. 13/901,341.
- USPTO; Notice of Allowance dated Jun. 6, 2014 in U.S. Appl. No. 13/901,341.

(56)

References Cited

OTHER PUBLICATIONS

- USPTO; Non-Final Office Action dated Jan. 2, 2015 in U.S. Appl. No. 13/901,372.
- USPTO; Final Office Action dated Apr. 16, 2015 in U.S. Appl. No. 13/901,372.
- USPTO; Notice of Allowance dated Aug. 5, 2015 in U.S. Appl. No. 13/901,372.
- USPTO; Advisory Action dated Jun. 29, 2015 in U.S. Appl. No. 13/901,372.
- USPTO; Non-Final Office Action dated Jul. 8, 2015 in U.S. Appl. No. 13/901,400.
- USPTO; Final Office Action dated Jan. 14, 2016 in U.S. Appl. No. 13/901,400.
- USPTO; Notice of Allowance dated Apr. 12, 2016 in U.S. Appl. No. 13/901,400.
- USPTO; Non-Final Office Action dated Apr. 24, 2014 in U.S. Appl. No. 13/912,666.
- USPTO; Final Office Action dated Sep. 25, 2014 in U.S. Appl. No. 13/912,666.
- USPTO; Advisory Action dated Dec. 11, 2014 in U.S. Appl. No. 13/912,666.
- USPTO; Non-Final Office Action dated Jan. 26, 2015 in U.S. Appl. No. 13/912,666.
- USPTO; Notice of Allowance dated Jun. 25, 2015 in U.S. Appl. No. 13/912,666.
- USPTO; Non-Final Office Action dated Dec. 16, 2014 in U.S. Appl. No. 13/915,732.
- USPTO; Final Office Action dated Apr. 10, 2015 in U.S. Appl. No. 13/915,732.
- USPTO; Notice of Allowance dated Jun. 19, 2015 in U.S. Appl. No. 13/915,732.
- USPTO; Notice of Allowance dated Mar. 17, 2015 in U.S. Appl. No. 13/923,197.
- USPTO; Non-Final Office Action dated Sep. 12, 2014 in U.S. Appl. No. 13/941,134.
- USPTO; Notice of Allowance dated Jan. 20, 2015 in U.S. Appl. No. 13/941,134.
- USPTO; Non-Final Office Action dated Jul. 30, 2015 in U.S. Appl. No. 13/941,216.
- USPTO; Final Office Action dated Mar. 1, 2016 in U.S. Appl. No. 13/941,216.
- USPTO; Non-Final Office Action dated Jun. 15, 2016 in U.S. Appl. No. 13/941,216.
- USPTO; Notice of Allowance dated Sep. 13, 2016 in U.S. Appl. No. 13/941,216.
- USPTO; Notice of Allowance dated Nov. 14, 2016 in U.S. Appl. No. 13/941,216.
- USPTO; Non-Final Office Action dated Jan. 14, 2014 in U.S. Appl. No. 13/941,226.
- USPTO; Non-Final Office Action dated Jul. 8, 2014 in U.S. Appl. No. 13/941,226.
- USPTO; Non-Final Office Action dated Feb. 3, 2015 in U.S. Appl. No. 13/941,226.
- USPTO; Final Office Action dated Feb. 12, 2016 in U.S. Appl. No. 13/941,226.
- USPTO; Advisory Action dated Jul. 29, 2016 in U.S. Appl. No. 13/941,226.
- USPTO; Non-Final Office Action dated Aug. 8, 2017 in U.S. Appl. No. 13/941,226.
- USPTO; Notice of Allowance dated Aug. 13, 2018 in U.S. Appl. No. 13/941,226.
- USPTO; Notice of Allowance dated Oct. 3, 2018 in U.S. Appl. No. 13/941,226.
- USPTO; Non-Final Office Action dated Oct. 30, 2014 in U.S. Appl. No. 13/948,055.
- USPTO; Notice of Allowance dated Feb. 27, 2015 in U.S. Appl. No. 13/948,055.
- USPTO; Notice of Allowance dated Mar. 31, 2015 in U.S. Appl. No. 13/948,055.
- USPTO; Non-Final Office Action dated Jun. 29, 2015 in U.S. Appl. No. 13/966,782.
- USPTO; Final Office Action dated Jan. 4, 2016 in U.S. Appl. No. 13/966,782.
- USPTO; Notice of Allowance dated Mar. 21, 2016 in U.S. Appl. No. 13/966,782.
- USPTO; Notice of Allowance dated Oct. 7, 2015 in U.S. Appl. No. 13/973,777.
- USPTO; Non-Final Office Action dated Feb. 20, 2015 in U.S. Appl. No. 14/018,231.
- USPTO; Notice of Allowance dated Jul. 20, 2015 in U.S. Appl. No. 14/018,231.
- USPTO; Non-Final Office Action dated Apr. 7, 2015 in U.S. Appl. No. 14/018,345.
- USPTO; Final Office Action dated Sep. 14, 2015 in U.S. Appl. No. 14/018,345.
- USPTO; Notice of Allowance dated Jan. 14, 2016 in U.S. Appl. No. 14/018,345.
- USPTO; Notice of Allowance dated Mar. 17, 2016 in U.S. Appl. No. 14/018,345.
- USPTO; Non-Final Office Action dated Mar. 26, 2015 in U.S. Appl. No. 14/031,982.
- USPTO; Final Office Action dated Aug. 28, 2015 in U.S. Appl. No. 14/031,982.
- USPTO; Notice of Allowance dated Nov. 17, 2015 in U.S. Appl. No. 14/031,982.
- USPTO; Non-Final Office Action dated Jan. 2, 2015 in U.S. Appl. No. 14/040,196.
- USPTO; Non-Final Office Action dated Apr. 28, 2015 in U.S. Appl. No. 14/040,196.
- USPTO; Notice of Allowance dated Sep. 11, 2015 in U.S. Appl. No. 14/040,196.
- USPTO; Non-Final Office Action dated Dec. 3, 2015 in U.S. Appl. No. 14/050,150.
- USPTO; Final Office Action dated Jun. 15, 2016 in U.S. Appl. No. 14/050,150.
- USPTO; Final Office Action dated Jul. 8, 2016 in U.S. Appl. No. 14/050,150.
- USPTO; Notice of Allowance dated Oct. 20, 2016 in U.S. Appl. No. 14/050,150.
- USPTO; Non-Final Office Action dated Dec. 15, 2014 in U.S. Appl. No. 14/065,114.
- USPTO; Final Office Action dated Jun. 19, 2015 in U.S. Appl. No. 14/065,114.
- USPTO; Advisory Action dated Aug. 24, 2015 in U.S. Appl. No. 14/065,114.
- USPTO; Non-Final Office Action dated Oct. 7, 2015 in U.S. Appl. No. 14/065,114.
- USPTO; Notice of Allowance dated Feb. 22, 2016 in U.S. Appl. No. 14/065,114.
- USPTO; Non-Final Office Action dated Nov. 14, 2014 in U.S. Appl. No. 14/069,244.
- USPTO; Notice of Allowance dated Mar. 25, 2015 in U.S. Appl. No. 14/069,244.
- USPTO; Non-Final Office Action dated Mar. 19, 2015 in U.S. Appl. No. 14/079,302.
- USPTO; Final Office Action dated Sep. 1, 2015 in U.S. Appl. No. 14/079,302.
- USPTO; Non-Final Office Action dated Dec. 23, 2015 in U.S. Appl. No. 14/079,302.
- USPTO; Non-Final Office Action dated Apr. 27, 2016 in U.S. Appl. No. 14/079,302.
- USPTO; Final Office Action dated Aug. 22, 2016 in U.S. Appl. No. 14/079,302.
- USPTO; Notice of Allowance dated Dec. 14, 2016 in U.S. Appl. No. 14/079,302.
- USPTO; Non-Final Office Action dated Sep. 9, 2015 in U.S. Appl. No. 14/090,750.
- USPTO; Final Office Action dated Feb. 11, 2016 in U.S. Appl. No. 14/090,750.
- USPTO; Advisory Action dated May 5, 2016 in U.S. Appl. No. 14/090,750.

(56)

References Cited

OTHER PUBLICATIONS

- USPTO; Non-Final Office Action dated Jun. 14, 2016 in U.S. Appl. No. 14/090,750.
- USPTO; Advisory Action dated Dec. 21, 2016 in U.S. Appl. No. 14/090,750.
- USPTO; Advisory Action dated Jan. 30, 2018 in U.S. Appl. No. 14/090,750.
- USPTO; Final Office Action dated Sep. 28, 2016 in U.S. Appl. No. 14/090,750.
- USPTO; Non-Final Office Action dated Jun. 23, 2017 in U.S. Appl. No. 14/090,750.
- USPTO; Final Office Action dated Nov. 17, 2017 in U.S. Appl. No. 14/090,750.
- USPTO; Non-Final Office Action dated Mar. 12, 2018 in U.S. Appl. No. 14/090,750.
- USPTO; Notice of Allowance dated Aug. 29, 2018 in U.S. Appl. No. 14/090,750.
- USPTO; Non-Final Office Action dated Mar. 19, 2015 in U.S. Appl. No. 14/166,462.
- USPTO; Notice of Allowance dated Sep. 3, 2015 in U.S. Appl. No. 14/166,462.
- USPTO; Non-Final Office Action dated Nov. 17, 2015 in U.S. Appl. No. 14/172,220.
- USPTO; Office Action dated May 29, 2014 in U.S. Appl. No. 14/183,187.
- USPTO; Final Office Action dated Nov. 7, 2014 in U.S. Appl. No. 14/183,187.
- USPTO; Advisory Action dated Feb. 20, 2015 in U.S. Appl. No. 14/183,187.
- USPTO; Non-Final Office Action dated Mar. 16, 2015 in U.S. Appl. No. 14/183,187.
- USPTO; Final Office Action dated Jul. 10, 2015 in U.S. Appl. No. 14/183,187.
- USPTO; Notice of Allowance dated Aug. 31, 2015 in U.S. Appl. No. 14/183,187.
- USPTO; Non-Final Office Action dated Jan. 11, 2016 in U.S. Appl. No. 14/188,760.
- USPTO; Final Office Action dated Aug. 25, 2016 in U.S. Appl. No. 14/188,760.
- USPTO; Advisory Action dated Jan. 12, 2017 in U.S. Appl. No. 14/188,760.
- USPTO; Non-Final Office Action dated Mar. 23, 2017 in U.S. Appl. No. 14/188,760.
- USPTO; Final Office Action dated Oct. 5, 2017 in U.S. Appl. No. 14/188,760.
- USPTO; Advisory Action dated Jan. 3, 2018 in U.S. Appl. No. 14/188,760.
- USPTO; Non-Final Office Action dated Apr. 18, 2018 in U.S. Appl. No. 14/188,760.
- USPTO; Final Office Action dated Jan. 25, 2019 in U.S. Appl. No. 14/188,760.
- USPTO; Non-Final Office Action dated Oct. 8, 2015 in U.S. Appl. No. 14/218,374.
- USPTO; Final Office Action dated Feb. 23, 2016 in U.S. Appl. No. 14/218,374.
- USPTO; Advisory Action dated Apr. 29, 2016 in U.S. Appl. No. 14/218,374.
- USPTO; Notice of Allowance dated Aug. 5, 2016 in U.S. Appl. No. 14/218,374.
- USPTO; Non-Final Office Action dated Jul. 15, 2016 in U.S. Appl. No. 14/218,690.
- USPTO; Final Office Action dated Nov. 14, 2016 in U.S. Appl. No. 14/218,690.
- USPTO; Non-Final Office Action dated Apr. 6, 2017 in U.S. Appl. No. 14/218,690.
- USPTO; Final Office Action dated Jul. 20, 2017 in U.S. Appl. No. 14/218,690.
- USPTO; Non-Final Office Action dated Jan. 11, 2018 in U.S. Appl. No. 14/218,690.
- USPTO; Final Office Action dated May 24, 2018 in U.S. Appl. No. 14/218,690.
- USPTO; Notice of Allowance dated Sep. 24, 2018 in U.S. Appl. No. 14/218,690.
- USPTO; Non-Final Office Action dated Sep. 22, 2015 in U.S. Appl. No. 14/219,839.
- USPTO; Final Office Action dated Mar. 25, 2016 in U.S. Appl. No. 14/219,839.
- USPTO; Non-Final Office Action dated Dec. 22, 2016 in U.S. Appl. No. 14/219,839.
- USPTO; Advisory Action dated Jun. 30, 2016 in U.S. Appl. No. 14/219,839.
- USPTO; Final Office Action dated Jul. 6, 2017 in U.S. Appl. No. 14/219,839.
- USPTO; Non-Final Office Action dated Mar. 27, 2018 in U.S. Appl. No. 14/219,839.
- USPTO; Final Office Action dated Nov. 1, 2018 in U.S. Appl. No. 14/219,839.
- USPTO; Advisory Action dated Jan. 22, 2019 in U.S. Appl. No. 14/219,839.
- USPTO; Non-Final Office Action dated Jul. 15, 2019 in U.S. Appl. No. 14/219,839.
- USPTO; Non-Final Office Action dated Nov. 25, 2015 in U.S. Appl. No. 14/219,879.
- USPTO; Final Office action dated May 19, 2016 in U.S. Appl. No. 14/219,879.
- USPTO; Advisory Action dated Aug. 22, 2016 in U.S. Appl. No. 14/219,879.
- USPTO; Non-Final Office Action dated Dec. 23, 2016 in U.S. Appl. No. 14/219,879.
- USPTO; Final Office action dated Jul. 6, 2017 in U.S. Appl. No. 14/219,879.
- USPTO; Advisory Action dated Oct. 5, 2017 in U.S. Appl. No. 14/219,879.
- USPTO; Non-Final Office Action dated Apr. 6, 2018 in U.S. Appl. No. 14/219,879.
- USPTO; Final Office Action dated Nov. 2, 2018 in U.S. Appl. No. 14/219,879.
- USPTO; Advisory Action dated Jan. 22, 2019 in U.S. Appl. No. 14/219,879.
- USPTO; Non-Final Office Action dated Jun. 24, 2019 in U.S. Appl. No. 14/219,879.
- USPTO; Non-Final Office Action dated Sep. 18, 2015 in U.S. Appl. No. 14/244,689.
- USPTO; Notice of Allowance dated Feb. 11, 2016 in U.S. Appl. No. 14/244,689.
- USPTO; Non-Final Office Action dated Oct. 7, 2015 in U.S. Appl. No. 14/246,969.
- USPTO; Final Office Action dated May 4, 2016 in U.S. Appl. No. 14/246,969.
- USPTO; Advisory Action dated Aug. 2, 2016 in U.S. Appl. No. 14/246,969.
- USPTO; Non-Final Office Action dated Aug. 12, 2016 in U.S. Appl. No. 14/246,969.
- USPTO; Notice of Allowance dated Feb. 27, 2017 in U.S. Appl. No. 14/246,969.
- USPTO; Non-Final Office Action dated Nov. 20, 2015 in U.S. Appl. No. 14/260,701.
- USPTO; Notice of Allowance dated Jun. 2, 2016 in U.S. Appl. No. 14/260,701.
- USPTO; Notice of Allowance dated Feb. 23, 2016 in U.S. Appl. No. 14/327,134.
- USPTO; Non-Final Office Action dated Aug. 19, 2015 in U.S. Appl. No. 14/268,348.
- USPTO; Non-Final Office Action dated Jan. 6, 2016 in U.S. Appl. No. 14/268,348.
- USPTO; Final Office Action dated Apr. 29, 2016 in U.S. Appl. No. 14/268,348.
- USPTO; Notice of Allowance dated Aug. 30, 2016 in U.S. Appl. No. 14/268,348.
- USPTO; Non-Final Office Action dated Oct. 20, 2015 in U.S. Appl. No. 14/281,477.

(56)

References Cited

OTHER PUBLICATIONS

- USPTO; Advisory Action dated Mar. 28, 2016 in U.S. Appl. No. 14/281,477.
- USPTO; Non-Final Office Action dated Jan. 13, 2017 in U.S. Appl. No. 14/444,744.
- USPTO; Final Office Action dated Jul. 10, 2017 in U.S. Appl. No. 14/444,744.
- USPTO; Non-Final Office Action dated Nov. 29, 2017 in U.S. Appl. No. 14/444,744.
- USPTO; Final Office Action dated Mar. 28, 2018 in U.S. Appl. No. 14/444,744.
- USPTO; Non-Final Office Action Dated Jul. 27, 2018 in U.S. Appl. No. 14/444,744.
- USPTO; Final Office Action dated Feb. 7, 2019 in U.S. Appl. No. 14/444,744.
- USPTO; Non-Final Office Action dated May 18, 2016 in U.S. Appl. No. 14/449,838.
- USPTO; Notice of Allowance dated Nov. 28, 2016 in U.S. Appl. No. 14/449,838.
- USPTO; Non-Final Office Action dated Feb. 12, 2015 in U.S. Appl. No. 14/457,058.
- USPTO; Final Office Action dated Jul. 14, 2015 in U.S. Appl. No. 14/457,058.
- USPTO; Non-Final Office Action dated Nov. 6, 2015 in U.S. Appl. No. 14/457,058.
- USPTO; Final Office Acton dated Jun. 17, 2016 in U.S. Appl. No. 14/457,058.
- USPTO; Advisory Action dated Sep. 21, 2016 in U.S. Appl. No. 14/457,058.
- USPTO; Non-Final Office Action dated Oct. 6, 2016 in U.S. Appl. No. 14/457,058.
- USPTO; Final Office Acton dated May 4, 2017 in U.S. Appl. No. 14/457,058.
- USPTO; Non-Final Office Action dated Oct. 19, 2017 in U.S. Appl. No. 14/457,058.
- USPTO; Final Office Action dated Jun. 14, 2018 in U.S. Appl. No. 14/457,058.
- USPTO; Non-Final Office Action dated Jan. 11, 2019 in U.S. Appl. No. 14/457,058.
- USPTO; Final Office Action dated Jun. 25, 2019 in U.S. Appl. No. 14/457,058.
- USPTO; Non-Final Office Action dated Sep. 16, 2016 in U.S. Appl. No. 14/465,252.
- USPTO; Final Office Action dated Nov. 1, 2016 in U.S. Appl. No. 14/465,252.
- USPTO; Non-Final Office Action dated Mar. 6, 2017 in U.S. Appl. No. 14/465,252.
- USPTO; Final Office Action dated Jun. 9, 2017 in U.S. Appl. No. 14/465,252.
- USPTO; Notice of Allowance dated Oct. 3, 2017 in U.S. Appl. No. 14/465,252.
- USPTO; Non-Final Office Action dated May 31, 2018 in U.S. Appl. No. 15/491,726.
- USPTO; Non-Final Office Action dated Nov. 24, 2015 in U.S. Appl. No. 14/498,036.
- USPTO; Final Office Action dated Apr. 5, 2016 in U.S. Appl. No. 14/498,036.
- USPTO; Advisory Action dated Jun. 16, 2016 in U.S. Appl. No. 14/498,036.
- USPTO; Notice of Allowance dated Aug. 17, 2016 in U.S. Appl. No. 14/498,036.
- USPTO; Non-Final Office Action dated Apr. 10, 2015 in U.S. Appl. No. 14/505,290.
- USPTO; Notice of Allowance dated Aug. 21, 2015 in U.S. Appl. No. 14/505,290.
- USPTO; Non-Final Office Action dated Dec. 17, 2015 in U.S. Appl. No. 14/508,296.
- USPTO; Final Office Action dated May 26, 2016 in U.S. Appl. No. 14/508,296.
- USPTO; Advisory Action dated Aug. 17, 2016 in U.S. Appl. No. 14/508,296.
- USPTO; Non-Final Office Action dated Sep. 8, 2016 in U.S. Appl. No. 14/508,296.
- USPTO; Final Office Action dated Dec. 7, 2016 in U.S. Appl. No. 14/508,296.
- USPTO; Notice of Allowance dated Jan. 27, 2017 in U.S. Appl. No. 14/508,296.
- USPTO; Non-Final Office Action dated Apr. 6, 2017 in U.S. Appl. No. 14/508,489.
- USPTO; Final Office Action dated Oct. 4, 2017 in U.S. Appl. No. 14/508,489.
- USPTO; Non-Final Office Action dated May 15, 2018 in U.S. Appl. No. 14/508,489.
- USPTO; Final Office Action dated Nov. 28, 2018 in U.S. Appl. No. 14/508,489.
- USPTO; Non-Final Office Action dated Apr. 4, 2019 in U.S. Appl. No. 14/508,489.
- USPTO; Non-Final Office Action dated Jan. 16, 2015 in U.S. Appl. No. 14/563,044.
- USPTO; Final Office Action dated Jul. 16, 2015 in U.S. Appl. No. 14/563,044.
- USPTO; Notice of Allowance dated Oct. 15, 2015 in U.S. Appl. No. 14/563,044.
- USPTO; Notice of Allowance dated Dec. 2, 2015 in U.S. Appl. No. 14/563,044.
- USPTO; Non-Final Office Action dated May 4, 2016 in U.S. Appl. No. 14/568,647.
- USPTO; Final Office Action dated Sep. 29, 2016 in U.S. Appl. No. 14/568,647.
- USPTO; Advisory Action dated Dec. 21, 2016 in U.S. Appl. No. 14/568,647.
- USPTO; Non-Final Office Action dated Feb. 2, 2017 in U.S. Appl. No. 14/568,647.
- USPTO; Final Office Action dated May 19, 2017 in U.S. Appl. No. 14/568,647.
- USPTO; Non-Final Office Action dated Sep. 14, 2017 in U.S. Appl. No. 14/568,647.
- USPTO; Final Office Action dated Jan. 23, 2018 in U.S. Appl. No. 14/568,647.
- USPTO; Advisory Action dated Apr. 12, 2018 in U.S. Appl. No. 14/568,647.
- USPTO; Non-Final Office Action dated May 25, 2018 in U.S. Appl. No. 14/568,647.
- USPTO; Non-Final Office Action dated Oct. 1, 2015 in U.S. Appl. No. 14/571,126.
- USPTO; Final Office Action dated Feb. 22, 2016 in U.S. Appl. No. 14/571,126.
- USPTO; Notice of Allowance dated May 18, 2016 in U.S. Appl. No. 14/571,126.
- USPTO; Notice of Allowance dated Jun. 2, 2016 in U.S. Appl. No. 14/571,126.
- USPTO; Non-Final Office Action dated Nov. 25, 2015 in U.S. Appl. No. 14/598,532.
- USPTO; Notice of Allowance dated May 16, 2016 in U.S. Appl. No. 14/598,532.
- USPTO; Non-Final Office Action dated Jan. 15, 2016 in U.S. Appl. No. 14/606,364.
- USPTO; Final Office Action dated Jun. 14, 2016 in U.S. Appl. No. 14/606,364.
- USPTO; Advisory Action dated Aug. 25, 2016 in U.S. Appl. No. 14/606,364.
- USPTO; Non-Final Office Action dated Sep. 27, 2016 in U.S. Appl. No. 14/606,354.
- USPTO; Final Office Action dated Jan. 12, 2017 in U.S. Appl. No. 14/606,364.
- USPTO; Non-Final Office Action dated May 10, 2017 in U.S. Appl. No. 14/606,364.
- USPTO; Non-Final Office Action dated Mar. 3, 2016 in U.S. Appl. No. 14/622,603.
- USPTO; Notice of Allowance dated Aug. 2, 2016 in U.S. Appl. No. 14/622,603.

(56)

References Cited

OTHER PUBLICATIONS

- USPTO; Notice of Allowance dated Feb. 16, 2016 in U.S. Appl. No. 14/634,342.
- USPTO; Non-Final Office Action dated Oct. 19, 2017 in U.S. Appl. No. 14/645,234.
- USPTO; Non-Final Office Action dated May 16, 2018 in U.S. Appl. No. 14/645,234.
- USPTO; Final Office Action dated Aug. 10, 2018 in U.S. Appl. No. 14/645,234.
- USPTO; Non-Final Office Action dated Jun. 7, 2017 in U.S. Appl. No. 14/656,588.
- USPTO; Final Office Action dated Dec. 26, 2017 in U.S. Appl. No. 14/656,588.
- USPTO; Non-Final Office Action dated Apr. 6, 2018 in U.S. Appl. No. 14/656,588.
- USPTO; Notice of Allowance dated Nov. 19, 2018 in U.S. Appl. No. 14/656,588.
- USPTO; Non-Final Office Action dated Mar. 21, 2016 in U.S. Appl. No. 14/659,152.
- USPTO; Final Office Action dated Jul. 29, 2016 in U.S. Appl. No. 14/659,152.
- USPTO; Notice of Allowance dated Nov. 22, 2016 in U.S. Appl. No. 14/659,152.
- USPTO; Non-Final Office Action dated Sep. 7, 2017 in Application No. 14/660,755.
- USPTO; Notice of Allowance dated Oct. 2, 2017 in U.S. Appl. No. 14/660,755.
- USPTO; Notice of Allowance dated Mar. 25, 2016 in U.S. Appl. No. 14/693,138.
- USPTO; Non-Final Office Action dated Aug. 3, 2017 in U.S. Appl. No. 14/752,712.
- USPTO; Final Office Action dated Nov. 29, 2017 in U.S. Appl. No. 14/752,712.
- USPTO; Advisory Action dated Feb. 15, 2018 in U.S. Appl. No. 14/752,712.
- USPTO; Non-Final Office Action dated Mar. 21, 2018 in U.S. Appl. No. 14/752,712.
- USPTO; Final Office Action dated Sep. 5, 2018 in U.S. Appl. No. 14/752,712.
- USPTO; Non-Final Office Action dated Dec. 28, 2018 in U.S. Appl. No. 14/752,712.
- USPTO; Notice of Allowance dated Jun. 11, 2019 in U.S. Appl. No. 14/752,712.
- USPTO; Non-Final Office Action dated Nov. 29, 2017 in U.S. Appl. No. 14/793,323.
- USPTO; Final Office Action dated Mar. 29, 2018 in U.S. Appl. No. 14/793,323.
- USPTO; Non-Final Office Action dated Aug. 10, 2018 in U.S. Appl. No. 14/793,323.
- USPTO; Final Office Action dated Feb. 25, 2019 in U.S. Appl. No. 14/793,323.
- USPTO; Non-Final Office Action dated Jun. 27, 2019 in U.S. Appl. No. 14/793,323.
- USPTO; Non-Final Office Action dated Jun. 16, 2017 in U.S. Appl. No. 14/798,136.
- USPTO; Notice of Allowance dated Oct. 5, 2017 in U.S. Appl. No. 14/798,136.
- USPTO; Non-Final Office Action dated Mar. 30, 2016 in U.S. Appl. No. 14/808,979.
- USPTO; Final Office Action dated Sep. 30, 2016 in U.S. Appl. No. 14/808,979.
- USPTO; Non-Final Office Action dated Dec. 20, 2016 in U.S. Appl. No. 14/808,979.
- USPTO; Final Office Action dated Jun. 8, 2017 in U.S. Appl. No. 14/808,979.
- USPTO; Non-Final Office Action dated Sep. 21, 2017 in U.S. Appl. No. 14/808,979.
- USPTO; Final Office Action dated Mar. 14, 2018 in U.S. Appl. No. 14/808,979.
- USPTO; Notice of Allowance dated Jun. 27, 2018 in U.S. Appl. No. 14/808,979.
- USPTO; Non-Final Office Action dated Feb. 23, 2018 in U.S. Appl. No. 14/817,953.
- USPTO; Notice of Allowance dated Jul. 11, 2018 in U.S. Appl. No. 14/817,953.
- USPTO; Notice of Allowance dated Jan. 27, 2017 in U.S. Appl. No. 14/827,177.
- USPTO; Non-Final Office Action dated Sep. 9, 2016 in U.S. Appl. No. 14/829,565.
- USPTO; Final Office Action dated Feb. 9, 2017 in U.S. Appl. No. 14/829,565.
- USPTO; Advisory Action dated Apr. 20, 2017 in U.S. Appl. No. 14/829,565.
- USPTO; Non-Final Office Action dated Sep. 19, 2017 in U.S. Appl. No. 14/829,565.
- USPTO; Final Office Action dated Mar. 5, 2018 in U.S. Appl. No. 14/829,565.
- USPTO; Advisory Action dated Aug. 10, 2018 in U.S. Appl. No. 14/829,565.
- USPTO; Non-Final Office Action dated Sep. 6, 2018 in U.S. Appl. No. 14/829,565.
- USPTO; Final Office Action dated Apr. 18, 2019 in U.S. Appl. No. 14/829,565.
- USPTO; Advisory Action dated Jul. 22, 2019 in U.S. Appl. No. 14/829,565.
- USPTO; Non-Final Office Action dated Apr. 29, 2016 in U.S. Appl. No. 14/835,637.
- USPTO; Final Office Action dated Nov. 25, 2016 in U.S. Appl. No. 14/835,637.
- USPTO; Advisory Action dated Feb. 14, 2017 in U.S. Appl. No. 14/835,637.
- USPTO; Notice of Allowance dated Apr. 25, 2017 in U.S. Appl. No. 14/835,637.
- USPTO; Non-Final Office Action dated Jul. 29, 2016 in U.S. Appl. No. 14/884,695.
- USPTO; Final Office Action dated Feb. 9, 2017 in U.S. Appl. No. 14/884,695.
- USPTO; Advisory Action dated Apr. 20, 2017 in U.S. Appl. No. 14/884,695.
- USPTO; Non-Final Office Action dated May 18, 2017 in U.S. Appl. No. 14/884,695.
- USPTO; Notice of Allowance dated Oct. 20, 2017 in U.S. Appl. No. 14/884,695.
- USPTO; Non-Final Office Action dated May 18, 2017 in U.S. Appl. No. 14/886,571.
- USPTO; Final Office Action dated Sep. 21, 2017 in U.S. Appl. No. 14/886,571.
- USPTO; Notice of Allowance dated Dec. 6, 2017 in U.S. Appl. No. 14/886,571.
- USPTO; Non-Final Office Action dated Dec. 1, 2016 in U.S. Appl. No. 14/919,536.
- USPTO; Final Office Action dated Mar. 28, 2017 in U.S. Appl. No. 14/919,536.
- USPTO; Non-Final Office Action dated Aug. 29, 2017 in U.S. Appl. No. 14/919,536.
- USPTO; Final Office Action dated May 11, 2018 in U.S. Appl. No. 14/919,536.
- USPTO; Notice of Allowance dated Oct. 4, 2018 in U.S. Appl. No. 14/919,536.
- USPTO; Notice of Allowance dated Nov. 19, 2018 in U.S. Appl. No. 14/919,536.
- USPTO; Non-Final Office Action dated May 3, 2016 in U.S. Appl. No. 14/937,053.
- USPTO; Notice of Allowance dated Jul. 26, 2016 in U.S. Appl. No. 14/937,053.
- USPTO; Non-Final Office Action dated Dec. 15, 2016 in U.S. Appl. No. 14/938,180.
- USPTO; Notice of Allowance dated Nov. 9, 2017 in U.S. Appl. No. 14/938,180.
- USPTO; Non-Final Office Action dated Apr. 14, 2017 in U.S. Appl. No. 14/956,115.

(56)

References Cited

OTHER PUBLICATIONS

- USPTO; Final Office Action dated Jul. 21, 2017 in U.S. Appl. No. 14/956,115.
- USPTO; Notice of Allowance dated Dec. 14, 2017 in U.S. Appl. No. 14/956,115.
- USPTO; Notice of Allowance dated Feb. 3, 2017 in U.S. Appl. No. 14/977,291.
- USPTO; Non-Final Office Action dated Aug. 12, 2016 in U.S. Appl. No. 14/981,434.
- USPTO; Notice of Allowance dated Nov. 21, 2016 in U.S. Appl. No. 14/981,434.
- USPTO; Non-Final Office Action dated Jan. 12, 2017 in U.S. Appl. No. 14/981,468.
- USPTO; Notice of Allowance dated Jun. 7, 2017 in U.S. Appl. No. 14/981,468.
- USPTO; Non-Final Office Action dated Mar. 22, 2016 in U.S. Appl. No. 14/987,420.
- USPTO; Non-Final Office Action dated Dec. 14, 2016 in U.S. Appl. No. 14/997,683.
- USPTO; Final Office Action dated Apr. 14, 2017 in U.S. Appl. No. 14/997,683.
- USPTO; Non-Final Office Action dated Sep. 1, 2017 in U.S. Appl. No. 14/997,683.
- USPTO; Final Office Action dated Feb. 6, 2018 in U.S. Appl. No. 14/997,683.
- USPTO; Advisory Action dated May 2, 2018 in U.S. Appl. No. 14/997,683.
- USPTO; Non-Final Office Action dated Jun. 20, 2018 in U.S. Appl. No. 14/997,683.
- USPTO; Final Office Action dated Dec. 10, 2018 in U.S. Appl. No. 14/997,683.
- USPTO; Notice of Allowance dated Mar. 25, 2019 in U.S. Appl. No. 14/997,683.
- USPTO; Non-Final Office Action dated Sep. 23, 2016 in U.S. Appl. No. 15/048,422.
- USPTO; Notice of Allowance dated May 4, 2017 in U.S. Appl. No. 15/048,422.
- USPTO; Non-Final Office Action dated Aug. 4, 2017 in U.S. Appl. No. 15/050,159.
- USPTO; Notice of Allowance dated Feb. 7, 2018 in U.S. Appl. No. 15/050,159.
- USPTO; Non-Final Office Action dated Apr. 22, 2016 in U.S. Appl. No. 15/055,122.
- USPTO; Notice of Allowance dated Sep. 15, 2016 in U.S. Appl. No. 15/055,122.
- USPTO; Non-Final Office Action dated Feb. 20, 2018 in U.S. Appl. No. 15/060,412.
- USPTO; Final Office Action dated Oct. 19, 2018 in U.S. Appl. No. 15/060,412.
- USPTO; Non-Final Office Action dated Jun. 3, 2019 in U.S. Appl. No. 15/060,412.
- USPTO; Non-Final Office Action dated Aug. 27, 2018 in U.S. Appl. No. 15/067,028.
- USPTO; Notice of Allowance dated Dec. 21, 2018 in U.S. Appl. No. 15/067,028.
- USPTO; Non-Final Office Action dated Sep. 26, 2018 in U.S. Appl. No. 15/074,813.
- USPTO; Notice of Allowance dated Feb. 25, 2019 in U.S. Appl. No. 15/074,813.
- USPTO; Non-Final Office Action dated Jan. 9, 2018 in U.S. Appl. No. 15/135,224.
- USPTO; Notice of Allowance dated Jun. 29, 2018 in U.S. Appl. No. 15/135,224.
- USPTO; Non-Final Office Action dated Jan. 9, 2018 in U.S. Appl. No. 15/135,258.
- USPTO; Final Office Action dated Jul. 6, 2018 in U.S. Appl. No. 15/135,258.
- USPTO; Non-Final Office Action dated Nov. 23, 2018 in U.S. Appl. No. 15/135,258.
- USPTO; Final Office Action dated Mar. 14, 2019 in U.S. Appl. No. 15/135,258.
- USPTO; Non-Final Office Action dated Jul. 19, 2019 in U.S. Appl. No. 15/135,258.
- USPTO; Non-Final Office Action dated Jan. 9, 2018 in U.S. Appl. No. 15/135,333.
- USPTO; Notice of Allowance dated Sep. 14, 2018 in U.S. Appl. No. 15/135,333.
- USPTO; Non-Final Office Action dated Nov. 21, 2016 in U.S. Appl. No. 15/144,481.
- USPTO; Final Office Action dated May 26, 2017 in U.S. Appl. No. 15/144,481.
- USPTO; Non-Final Office Action dated Sep. 21, 2017 in U.S. Appl. No. 15/144,481.
- USPTO; Notice of Allowance dated Apr. 11, 2018 in U.S. Appl. No. 15/144,481.
- USPTO; Non-Final Office Action dated Apr. 13, 2017 in U.S. Appl. No. 15/144,506.
- USPTO; Final Office Action dated Oct. 10, 2017 in U.S. Appl. No. 15/144,506.
- USPTO; Final Office Action dated Jul. 26, 2018 in U.S. Appl. No. 15/144,506.
- USPTO; Notice of Allowance dated Mar. 13, 2019 in U.S. Appl. No. 15/144,506.
- USPTO; Non-Final Office Action dated Oct. 9, 2018 in U.S. Appl. No. 15/182,504.
- USPTO; Final Office Action dated Mar. 28, 2019 in U.S. Appl. No. 15/182,504.
- USPTO; Notice of Allowance dated Jul. 17, 2019 in U.S. Appl. No. 15/182,504.
- USPTO; Non-Final Office Action dated Nov. 28, 2016 in U.S. Appl. No. 15/203,632.
- USPTO; Final Office Action dated Jun. 7, 2017 in U.S. Appl. No. 15/203,632.
- USPTO; Advisory Action dated Aug. 23, 2017 in U.S. Appl. No. 15/203,632.
- USPTO; Notice of Allowance dated Sep. 20, 2017 in U.S. Appl. No. 15/203,632.
- USPTO; Non-Final Office Action dated Nov. 29, 2016 in U.S. Appl. No. 15/203,642.
- USPTO; Final Office Action dated Apr. 13, 2017 in U.S. Appl. No. 15/203,642.
- USPTO; Advisory Action dated Jun. 22, 2017 in U.S. Appl. No. 15/203,642.
- USPTO; Notice of Allowance dated Aug. 7, 2017 in U.S. Appl. No. 15/203,642.
- USPTO; Non-Final Office Action dated Jun. 1, 2017 in U.S. Appl. No. 15/205,827.
- USPTO; Final Office Action dated Oct. 16, 2017 in U.S. Appl. No. 15/205,827.
- USPTO; Non-Final Office Action dated May 14, 2018 in U.S. Appl. No. 15/205,827.
- USPTO; Final Office Action dated Oct. 9, 2018 in U.S. Appl. No. 15/205,827.
- USPTO; Non-Final Office Action dated Mar. 28, 2019 in U.S. Appl. No. 15/205,827.
- USPTO; Non-Final Office Action dated Mar. 31, 2017 in U.S. Appl. No. 15/205,890.
- USPTO; Notice of Allowance dated Oct. 16, 2017 in U.S. Appl. No. 15/205,890.
- USPTO; Non-Final Office Action dated Jan. 20, 2017 in U.S. Appl. No. 15/210,256.
- USPTO; Notice of Allowance dated May 18, 2017 in U.S. Appl. No. 15/210,256.
- USPTO; Notice of Allowance dated Jul. 24, 2017 in U.S. Appl. No. 15/210,256.
- USPTO; Non-Final Office Action dated Apr. 21, 2017 in U.S. Appl. No. 15/222,715.
- USPTO; Notice of Allowance dated Jul. 14, 2017 in U.S. Appl. No. 15/222,715.
- USPTO; Notice of Allowance dated Sep. 27, 2017 in U.S. Appl. No. 15/222,715.

(56)

References Cited

OTHER PUBLICATIONS

- USPTO; Non-Final Office Action dated Feb. 3, 2017 in U.S. Appl. No. 15/222,738.
- USPTO; Notice of Allowance dated Feb. 3, 2017 in U.S. Appl. No. 15/222,738.
- USPTO; Notice of Allowance dated May 22, 2017 in U.S. Appl. No. 15/222,738.
- USPTO; Notice of Allowance dated Aug. 23, 2017 in U.S. Appl. No. 15/222,738.
- USPTO; Non-Final Office Action dated Jan. 17, 2017 in U.S. Appl. No. 15/222,749.
- USPTO; Final Office Action dated May 5, 2017 in U.S. Appl. No. 15/222,749.
- USPTO; Non-Final Office Action dated Sep. 7, 2017 in U.S. Appl. No. 15/222,749.
- USPTO; Final Office Action dated Jun. 4, 2018 in U.S. Appl. No. 15/222,749.
- USPTO; Notice of Allowance dated Aug. 30, 2018 in U.S. Appl. No. 15/222,749.
- USPTO; Non-Final Office Action dated Jan. 3, 2017 in U.S. Appl. No. 15/222,780.
- USPTO; Final Office Action dated May 5, 2017 in U.S. Appl. No. 15/222,780.
- USPTO; Non-Final Office Action dated Sep. 7, 2017 in U.S. Appl. No. 15/222,780.
- USPTO; Final Office Action dated May 17, 2018 in U.S. Appl. No. 15/222,780.
- USPTO; Non-Final Office Action dated Oct. 1, 2018 in U.S. Appl. No. 15/222,780.
- USPTO; Notice of Allowance dated Apr. 19, 2019 in U.S. Appl. No. 15/222,780.
- USPTO; Notice of Allowance dated Jul. 12, 2018 in U.S. Appl. No. 15/254,605.
- USPTO; Non-Final Office Action dated Aug. 28, 2017 in U.S. Appl. No. 15/254,724.
- USPTO; Notice of Allowance dated Jan. 17, 2018 in U.S. Appl. No. 15/254,724.
- USPTO; Notice of Allowance dated Apr. 2, 2018 in U.S. Appl. No. 15/254,724.
- USPTO; Non-Final Office Action dated May 22, 2018 in U.S. Appl. No. 15/262,990.
- USPTO; Non-Final Office Action dated Sep. 13, 2018 in U.S. Appl. No. 15/262,990.
- USPTO; Non-Final Office Action dated Jan. 30, 2019 in U.S. Appl. No. 15/262,990.
- USPTO; Final Office Action dated May 13, 2019 in U.S. Appl. No. 15/262,990.
- USPTO; Advisory Action dated Jul. 22, 2019 in U.S. Appl. No. 15/262,990.
- USPTO; Non-Final Office Action dated Aug. 3, 2018 in U.S. Appl. No. 15/273,488.
- USPTO; Final Office Action dated Jan. 11, 2019 in U.S. Appl. No. 15/273,488.
- USPTO; Notice of Allowance dated Apr. 19, 2019 in U.S. Appl. No. 15/273,488.
- USPTO; Non-Final Office Action dated Jul. 2, 2018 in U.S. Appl. No. 15/286,503.
- USPTO; Final Office Action dated Feb. 7, 2019 in U.S. Appl. No. 15/286,503.
- USPTO; Non-Final Office Action dated Jun. 27, 2019 in U.S. Appl. No. 15/286,503.
- USPTO; Non-Final Office Action dated Dec. 14, 2018 in U.S. Appl. No. 15/340,512.
- USPTO; Notice of Allowance dated May 24, 2019 in U.S. Appl. No. 15/340,512.
- USPTO; Non-Final Office Action dated Oct. 23, 2017 in U.S. Appl. No. 15/377,439.
- USPTO; Final Office Action dated Apr. 16, 2018 in U.S. Appl. No. 15/377,439.
- USPTO; Advisory Action dated Aug. 8, 2018 in U.S. Appl. No. 15/377,439.
- USPTO; Non-Final Office Action dated Nov. 14, 2018 in U.S. Appl. No. 15/377,439.
- USPTO; Final Office Action dated Jun. 25, 2019 in U.S. Appl. No. 15/377,439.
- USPTO; Notice of Allowance dated Aug. 8, 2017 in U.S. Appl. No. 15/380,895.
- USPTO; Notice of Allowance dated Oct. 11, 2017 in U.S. Appl. No. 15/380,895.
- USPTO; Non-Final Office Action dated May 31, 2019 in U.S. Appl. No. 15/380,909.
- USPTO; Non-Final Office Action dated Jan. 4, 2018 in U.S. Appl. No. 15/380,921.
- USPTO; Final Office Action dated Jun. 28, 2018 in U.S. Appl. No. 15/380,921.
- USPTO; Non-Final Office Action dated Feb. 25, 2019 in U.S. Appl. No. 15/380,921.
- USPTO; Non-Final Office Action dated Oct. 3, 2017 in U.S. Appl. No. 15/388,410.
- USPTO; Final Office Action dated May 15, 2018 in U.S. Appl. No. 15/388,410.
- USPTO; Notice of Allowance dated Nov. 14, 2018 in U.S. Appl. No. 15/388,410.
- USPTO; Notice of Allowance dated Dec. 28, 2018 in U.S. Appl. No. 15/388,410.
- USPTO; Non-Final Office Action dated Aug. 11, 2017 in U.S. Appl. No. 15/397,237.
- USPTO; Notice of Allowance dated Dec. 22, 2017 in U.S. Appl. No. 15/397,237.
- USPTO; Non-Final Office Action dated Apr. 12, 2017 in U.S. Appl. No. 15/397,319.
- USPTO; Final Office Action dated Jul. 12, 2017 in U.S. Appl. No. 15/397,319.
- USPTO; Notice of Allowance dated Dec. 15, 2017 in U.S. Appl. No. 15/397,319.
- USPTO; Non-Final Office Action dated Feb. 5, 2019 in U.S. Appl. No. 15/402,993.
- USPTO; Final Office Action dated May 21, 2019 in U.S. Appl. No. 15/402,993.
- USPTO; Non-Final Office Action dated Sep. 20, 2018 in U.S. Appl. No. 15/410,503.
- USPTO; Final Office Action dated Feb. 4, 2019 in U.S. Appl. No. 15/410,503.
- USPTO; Non-Final Office Action dated Apr. 25, 2019 in U.S. Appl. No. 15/410,503.
- USPTO; Non-Final Office Action dated Aug. 7, 2018 in U.S. Appl. No. 15/428,808.
- USPTO; Final Office Action dated Jan. 11, 2019 in U.S. Appl. No. 15/428,808.
- USPTO; Notice of Allowance dated Apr. 25, 2019 in U.S. Appl. No. 15/428,808.
- USPTO; Non-Final Office Action dated Apr. 6, 2018 in U.S. Appl. No. 15/434,051.
- USPTO; Final Office Action dated Aug. 29, 2018 in U.S. Appl. No. 15/434,051.
- USPTO; Advisory Action dated Dec. 4, 2018 in U.S. Appl. No. 15/434,051.
- USPTO; Non-Final Office Action dated Jan. 25, 2019 in U.S. Appl. No. 15/434,051.
- USPTO; Notice of Allowance dated Jun. 3, 2019 in U.S. Appl. No. 15/434,051.
- USPTO; Notice of Allowance dated Oct. 6, 2017 in U.S. Appl. No. 15/450,199.
- USPTO; Non-Final Office Action dated Dec. 15, 2017 in U.S. Appl. No. 15/466,149.
- USPTO; Notice of Allowance dated Apr. 20, 2018 in U.S. Appl. No. 15/466,149.
- USPTO; Non-Final Office Action dated Apr. 6, 2018 in U.S. Appl. No. 15/472,750.
- USPTO; Notice of Allowance dated Nov. 30, 2018 in U.S. Appl. No. 15/472,750.

(56)

References Cited

OTHER PUBLICATIONS

- USPTO; Non-Final Office Action dated Oct. 4, 2017 in U.S. Appl. No. 15/489,453.
- USPTO; Final Office Action dated Apr. 19, 2018 in U.S. Appl. No. 15/489,453.
- USPTO; Non-Final Office Action dated Sep. 10, 2018 in U.S. Appl. No. 15/489,453.
- USPTO; Final Office Action dated Feb. 27, 2019 in U.S. Appl. No. 15/489,453.
- USPTO; Non-Final Office Action dated Jun. 5, 2019 in U.S. Appl. No. 15/489,453.
- USPTO; Notice of Allowance dated Dec. 19, 2017 in U.S. Appl. No. 15/489,660.
- USPTO; Non-Final Office Action dated Dec. 6, 2017 in U.S. Appl. No. 15/476,035.
- USPTO; Notice of Allowance dated Mar. 21, 2018 in U.S. Appl. No. 15/476,035.
- USPTO; Notice of Allowance dated Aug. 14, 2018 in U.S. Appl. No. 15/476,035.
- USPTO; Final Office Action dated May 1, 2019 in U.S. Appl. No. 15/491,726.
- USPTO; Non-Final Office Action dated Jan. 16, 2018 in U.S. Appl. No. 15/499,647.
- USPTO; Notice of Allowance dated May 23, 2018 in U.S. Appl. No. 15/499,647.
- USPTO; Non-Final Office Action dated Jun. 21, 2018 in U.S. Appl. No. 15/499,647.
- USPTO; Notice of Allowance dated Nov. 1, 2018 in U.S. Appl. No. 15/499,647.
- USPTO; Notice of Allowance dated Nov. 15, 2018 in U.S. Appl. No. 15/499,647.
- USPTO; Office Action dated Aug. 30, 2018 in U.S. Appl. No. 15/589,849.
- USPTO; Final Office Action dated Mar. 6, 2019 in U.S. Appl. No. 15/589,849.
- USPTO; Non-Final Office Action dated Jun. 28, 2019 in U.S. Appl. No. 15/589,849.
- USPTO; Office Action dated May 3, 2018 in U.S. Appl. No. 15/589,861.
- USPTO; Non-Final Office Action dated Dec. 21, 2018 in U.S. Appl. No. 15/589,861.
- USPTO; Final Office Action dated Jun. 26, 2019 in U.S. Appl. No. 15/589,861.
- USPTO; Non-Final Office Action dated Apr. 4, 2018 in U.S. Appl. No. 15/592,730.
- USPTO; Final Office Action dated Nov. 16, 2018 in U.S. Appl. No. 15/592,730.
- USPTO; Advisory Action dated Mar. 15, 2019 in U.S. Appl. No. 15/592,730.
- USPTO; Non-Final Office Action dated Mar. 7, 2019 in U.S. Appl. No. 15/598,169.
- USPTO; Final Office Action dated Jun. 25, 2019 in U.S. Appl. No. 15/598,169.
- USPTO; Ex Parte Quayle Action dated Mar. 21, 2019 in U.S. Appl. No. 15/615,489.
- USPTO; Non-Final Office Action dated Feb. 1, 2019 in U.S. Appl. No. 15/627,189.
- USPTO; Notice of Allowance dated May 21, 2019 in U.S. Appl. No. 15/627,189.
- USPTO; Non-Final Office Action dated Nov. 9, 2018 in U.S. Appl. No. 15/636,307.
- USPTO; Final Office Action dated Mar. 6, 2019 in U.S. Appl. No. 15/636,307.
- USPTO; Non-Final Office Action dated Jul. 16, 2019 in U.S. Appl. No. 15/636,307.
- USPTO; Notice of Allowance dated Jul. 18, 2018 in U.S. Appl. No. 15/640,239.
- USPTO; Notice of Allowance dated Aug. 30, 2018 in U.S. Appl. No. 15/640,239.
- USPTO; Non-Final Office Action dated Jun. 5, 2018 in U.S. Appl. No. 15/650,686.
- USPTO; Final Office Action dated Nov. 20, 2018 in U.S. Appl. No. 15/650,686.
- USPTO; Notice of Allowance dated Jun. 24, 2019 in U.S. Appl. No. 15/650,686.
- USPTO; Non-Final Office Action dated Sep. 21, 2018 in U.S. Appl. No. 15/659,631.
- USPTO; Notice of Allowance dated Feb. 21, 2019 in U.S. Appl. No. 15/659,631.
- USPTO; Non-Final Office Action dated Aug. 9, 2018 in U.S. Appl. No. 15/660,805.
- USPTO; Non-Final Office Action dated Mar. 1, 2019 in U.S. Appl. No. 15/660,805.
- USPTO; Non-Final Office Action dated Aug. 27, 2018 in U.S. Appl. No. 15/662,107.
- USPTO; Notice of Allowance dated Feb. 21, 2019 in U.S. Appl. No. 15/662,107.
- USPTO; Non-Final Office Action dated Dec. 4, 2018 in U.S. Appl. No. 15/672,063.
- USPTO; Notice of Allowance dated Mar. 20, 2019 in U.S. Appl. No. 15/672,063.
- USPTO; Non-Final Office Action dated Feb. 8, 2019 in U.S. Appl. No. 15/672,119.
- USPTO; Final Office Action dated Jul. 16, 2019 in U.S. Appl. No. 15/672,119.
- USPTO; Non-Final Office Action dated Jul. 27, 2018 in U.S. Appl. No. 15/673,110.
- USPTO; Notice of Allowance dated Jan. 9, 2019 in U.S. Appl. No. 15/673,110.
- USPTO; Non-Final Office Action dated Apr. 25, 2018 in U.S. Appl. No. 15/673,278.
- USPTO; Notice of Allowance dated May 6, 2019 in U.S. Appl. No. 15/673,278.
- USPTO; Non-Final Office Action dated Jan. 18, 2018 in U.S. Appl. No. 15/683,701.
- USPTO; Notice of Allowance dated Jan. 9, 2019 in U.S. Appl. No. 15/683,701.
- USPTO; Final Office Action dated Aug. 24, 2018 in U.S. Appl. No. 15/683,701.
- USPTO; Advisory Action dated Nov. 26, 2018 in U.S. Appl. No. 15/683,701.
- USPTO; Non-Final Office Action dated Dec. 18, 2018 in U.S. Appl. No. 15/690,017.
- USPTO; Non-Final Office Action dated Aug. 9, 2018 in U.S. Appl. No. 15/691,241.
- USPTO; Non-Final Office Action dated Mar. 19, 2019 in U.S. Appl. No. 15/691,241.
- USPTO; Final Office Action dated Jan. 11, 2019 in U.S. Appl. No. 15/691,241.
- USPTO; Non-Final Office Action dated Dec. 6, 2018 in U.S. Appl. No. 15/705,955.
- USPTO; Notice of Allowance dated Apr. 16, 2019 in U.S. Appl. No. 15/705,955.
- USPTO; Non-Final Office Action dated Feb. 11, 2019 in U.S. Appl. No. 15/707,786.
- USPTO; Non-Final Office Action dated Jun. 14, 2018 in U.S. Appl. No. 15/711,989.
- USPTO; Notice of Allowance dated Dec. 6, 2018 in U.S. Appl. No. 15/711,989.
- USPTO; Non-Final Office Action dated May 29, 2018 in U.S. Appl. No. 15/719,208.
- USPTO; Final Office Action dated Dec. 13, 2018 in U.S. Appl. No. 15/719,208.
- USPTO; Non-Final Office Action dated Jun. 25, 2019 in U.S. Appl. No. 15/719,208.
- USPTO; Non-Final Office Action dated Oct. 4, 2018 in U.S. Appl. No. 15/726,222.
- USPTO; Notice of Allowance dated Apr. 19, 2019 in U.S. Appl. No. 15/726,222.
- USPTO; Non-Final Office Action dated Apr. 19, 2018 in U.S. Appl. No. 15/726,959.

(56)

References Cited

OTHER PUBLICATIONS

- USPTO; Final Office Action dated Nov. 14, 2018 in U.S. Appl. No. 15/726,959.
- USPTO; Non-Final Office Action dated May 17, 2018 in U.S. Appl. No. 15/729,485.
- USPTO; Notice of Allowance dated Jan. 23, 2019 in U.S. Appl. No. 15/729,485.
- USPTO; Non-Final Office Action dated Nov. 28, 2018 in U.S. Appl. No. 15/795,056.
- USPTO; Final Office Action dated Apr. 19, 2019 in U.S. Appl. No. 15/795,056.
- USPTO; Non-Final Office Action dated Jun. 26, 2018 in U.S. Appl. No. 15/796,593.
- USPTO; Final Office Action dated Feb. 21, 2019 in U.S. Appl. No. 15/796,593.
- USPTO; Non-Final Office Action dated Dec. 26, 2017 in U.S. Appl. No. 15/798,120.
- USPTO; Notice of Allowance dated Jun. 13, 2018 in U.S. Appl. No. 15/798,120.
- USPTO; Non-Final Office Action dated Dec. 21, 2018 in U.S. Appl. No. 15/798,150.
- USPTO; Notice of Allowance dated May 14, 2019 in U.S. Appl. No. 15/798,150.
- USPTO; Non-Final Office Action dated Aug. 9, 2018 in U.S. Appl. No. 15/798,201.
- USPTO; Final Office Action dated Dec. 14, 2018 in U.S. Appl. No. 15/798,201.
- USPTO; Non-Final Office Action dated Jul. 2, 2018 in U.S. Appl. No. 15/815,483.
- USPTO; Final Office Action dated Mar. 7, 2019 in U.S. Appl. No. 15/815,483.
- USPTO; Non-Final Office Action dated Sep. 26, 2018 in U.S. Appl. No. 15/832,188.
- USPTO; Notice of Allowance dated Dec. 5, 2017 in U.S. Appl. No. 15/832,188.
- USPTO; Non-Final Office Action dated Sep. 10, 2018 in U.S. Appl. No. 15/836,547.
- USPTO; Non-Final Office Action dated Mar. 13, 2019 in U.S. Appl. No. 15/836,547.
- USPTO; Non-Final Office Action dated Jul. 23, 2018 in U.S. Appl. No. 15/863,340.
- USPTO; Notice of Allowance dated Dec. 10, 2018 in U.S. Appl. No. 15/863,340.
- USPTO; Non-Final Office Action dated Jan. 11, 2019 in U.S. Appl. No. 15/879,209.
- USPTO; Non-Final Office Action dated Jan. 22, 2019 in U.S. Appl. No. 15/879,209.
- USPTO; Non-Final Office Action dated Apr. 17, 2019 in U.S. Appl. No. 15/886,225.
- USPTO; Non-Final Office Action dated Nov. 15, 2018 in U.S. Appl. No. 15/890,037.
- USPTO; Final Office Action dated May 2, 2019 in U.S. Appl. No. 15/890,037.
- USPTO; Notice of Allowance dated Feb. 8, 2019 in U.S. Appl. No. 15/892,756.
- USPTO; Non-Final Office Action dated Apr. 24, 2019 in U.S. Appl. No. 15/896,986.
- USPTO; Non-Final Office Action dated May 30, 2019 in U.S. Appl. No. 15/900,425.
- USPTO; Non-Final Office Action dated Mar. 8, 2019 in U.S. Appl. No. 15/917,224.
- USPTO; Non-Final Office Action dated Feb. 8, 2019 in U.S. Appl. No. 15/917,262.
- USPTO; Final Office Action dated Jun. 14, 2019 in U.S. Appl. No. 15/917,262.
- USPTO; Non-Final Office Action dated May 8, 2019 in U.S. Appl. No. 15/925,532.
- USPTO; Non-Final Office Action dated Mar. 29, 2019 in U.S. Appl. No. 15/940,801.
- USPTO; Notice of Allowance dated May 31, 2019 in U.S. Appl. No. 15/957,565.
- USPTO; Non-Final Office Action dated Apr. 19, 2019 in U.S. Appl. No. 15/985,298.
- USPTO; Non-Final Office Action dated Feb. 21, 2019 in U.S. Appl. No. 15/987,755.
- USPTO; Non-Final Office Action dated Jul. 16, 2019 in U.S. Appl. No. 16/014,981.
- USPTO; Non-Final Office Action dated Jan. 24, 2019 in U.S. Appl. No. 16/018,692.
- USPTO; Notice of Allowance dated Apr. 9, 2019 in U.S. Appl. No. 16/026,711.
- USPTO; Non-Final Office Action dated Apr. 25, 2019 in U.S. Appl. No. 16/038,024.
- USPTO; Non-Final Office Action dated Apr. 2, 2019 in U.S. Appl. No. 16/147,047.
- USPTO; Notice of Allowance dated Apr. 17, 2019 in U.S. Appl. No. 16/171,098.
- USPTO; Notice of Allowance dated May 1, 2019 in U.S. Appl. No. 16/171,098.
- USPTO; Non-Final Office Action dated Apr. 2, 2019 in U.S. Appl. No. 16/188,690.
- USPTO; Notice of Allowance dated Jun. 13, 2019 in U.S. Appl. No. 16/396,475.
- USPTO; Notice of Allowance dated May 14, 2012 in U.S. Appl. No. 29/411,637.
- USPTO; Notice of Allowance dated Oct. 2, 2013 in U.S. Appl. No. 29/412,887.
- USPTO; Non-Final Office Action dated Mar. 16, 2015 in U.S. Appl. No. 29/447,298.
- USPTO; Notice of Allowance dated Jul. 6, 2015 in U.S. Appl. No. 29/447,298.
- USPTO; Notice of Allowance dated Dec. 19, 2013 in U.S. Appl. No. 29/448,094.
- USPTO; Notice of Allowance dated Nov. 26, 2014 in U.S. Appl. No. 29/481,301.
- USPTO; Notice of Allowance dated Feb. 17, 2015 in U.S. Appl. No. 29/481,308.
- USPTO; Notice of Allowance dated Jan. 12, 2015 in U.S. Appl. No. 29/481,312.
- USPTO; Notice of Allowance dated Apr. 30, 2015 in U.S. Appl. No. 29/481,315.
- USPTO; Notice of Allowance dated May 11, 2015 in U.S. Appl. No. 29/511,011.
- USPTO; Notice of Allowance dated May 11, 2015 in U.S. Appl. No. 29/514,153.
- USPTO; Notice of Allowance dated Dec. 14, 2015 in U.S. Appl. No. 29/514,264.
- USPTO; Notice of Allowance dated Jun. 16, 2017 in U.S. Appl. No. 29/570,711.
- USPTO; Non-Final Office Action dated Apr. 16, 2019 in U.S. Appl. No. 29/604,101.
- USPTO; Notice of Allowance dated Jun. 26, 2018 in U.S. Appl. No. 29/604,288.
- USPTO; Non-Final Office Action dated Feb. 20, 2019 in U.S. Appl. No. 29/646,377.
- WIPO; International Search Report and Written Opinion dated Nov. 16, 2017 in Application No. PCT/IB2017/001015.
- WIPO; International Search Report and Written Opinion dated Nov. 13, 2017 in Application No. PCT/IB2017/001050.
- WIPO; International Search Report and Written Opinion dated Nov. 30, 2017 in Application No. PCT/IB2017/001070.
- WIPO; International Search Report and Written Opinion dated Jan. 25, 2018 in Application No. PCT/IB2017/001262.
- WIPO; International Search Report and Written Opinion dated Sep. 14, 2018 in Application No. PCT/IB2017/001640.
- WIPO; International Search Report and Written Opinion dated Jun. 1, 2018 in Application No. PCT/IB2017/001644.
- WIPO; International Search Report and Written Opinion dated Nov. 6, 2018 in Application No. PCT/IB2017/001652.
- WIPO; International Search Report and Written Opinion dated Jun. 1, 2018 in Application No. PCT/IB2017/001656.

(56)

References Cited

OTHER PUBLICATIONS

- WIPO; International Search Report and Written Opinion dated Jan. 25, 2019 in Application No. PCT/IB2018/000192.
- WIPO; International Search Report and Written Opinion dated Jul. 9, 2018 in Application No. PCT/IB2018/000419.
- WIPO; International Search Report and Written Opinion dated Jan. 4, 2019 in Application No. PCT/IB2018/000936.
- WIPO; International Search Report and Written Opinion dated Dec. 20, 2018 in Application No. PCT/IB2018/001003.
- WIPO; International Search Report and Written Opinion dated Dec. 20, 2018 in Application No. PCT/IB2018/001022.
- WIPO; International Search Report and Written Opinion dated May 23, 2019 in Application No. PCT/IB2019/050974.
- WIPO; International Preliminary Report on Patentability dated Nov. 24, 2009 and International Search Report dated Jul. 31, 2008 in Application No. PCT/US2008/063919.
- WIPO; International Preliminary Report on Patentability dated Feb. 24, 2010 in Application No. PCT/US2008/074063.
- WIPO; International Preliminary Report on Patentability dated Nov. 26, 2009 in Application No. PCT/US2009/043454.
- WIPO; International Preliminary Report on Patentability dated Jun. 14, 2011 in Application No. PCT/US2009/066377.
- WIPO; International Search report and Written Opinion dated Nov. 12, 2010 in Application No. PCT/US2010/030126.
- WIPO; International Preliminary Report on Patentability dated Oct. 11, 2011 Application No. PCT/US2010/030126.
- WIPO; International Preliminary Report on Patentability dated Nov. 9, 2011 in Application No. PCT/US2010/033244.
- WIPO; International Preliminary Report on Patentability dated Nov. 9, 2011 in Application No. PCT/US2010/033248.
- WIPO; International Preliminary Report on Patentability dated Nov. 9, 2011 in Application No. PCT/US2010/033252.
- WIPO; International Search report and Written Opinion dated Jan. 20, 2011 in Application No. PCT/US2010/045368.
- WIPO; International Search report and Written Opinion dated Feb. 6, 2013 in Application No. PCT/US2012/065343.
- WIPO; International Search report and Written Opinion dated Feb. 13, 2013 in Application No. PCT/US2012/065347.
- Arita et al. "Electrical and optical properties of germanium-doped zinc oxide thin films" *Materials Transactions*, vol. 45, No. 11, pp. 3180-3183 (2004).
- Arnold et al., "Novel single-layer vanadium sulphide phases" *2D Materials*, 5, 045009, 11 pages (2018).
- Athavale et al., "Realization of Atomic Layer Etching of Silicon", *Journal of Vacuum Science and Technology B*, vol. 14, pp. 3702-3705 (1996).
- Bearzotti, et al., "Fast Humidity Response of a Metal Halide-Doped Novel Polymer," *Sensors and Actuators B*, 7, pp. 451-454, (1992).
- Becker et al., "Atomic Layer Deposition of Insulating Hafnium and Zirconium Nitrides," *Chem. Mater.*, 16, 3497-3501 (2004).
- Beynet et al. "Low temperature plasma-enhanced ALD enables cost-effective spacer defined double patterning," *Proceedings of SPIE*, 7520, (2009).
- Bhatnagar et al., "Copper Interconnect Advances to Meet Moore's Law Milestones," *Solid State Technology*, 52, 10 (2009).
- Boscher et al., "Atmosphere Pressure Chemical Vapour Deposition of NbSe₂ Thin Films on Glass" *Eur. J. Inorg. Chem.*, pp. 1255-1259 (2006).
- Buriak, "Organometallic Chemistry on Silicon and Germanium Surfaces," *Chemical Reviews*, 102, 5 (2002).
- Cant et al., "Chemisorption Sites on Porous Silica Glass and on Mixed-Oxide Catalysis," *Can. J. Chem.* 46, 1373 (1968).
- Carmalt et al., "Chemical Vapor Deposition of Niobium Disulfide Thin Films" *Eur. J. Inorg. Chem.*, pp. 4470-4476 (2004).
- Casey et al. "Chemical Vapor Deposition of Mo onto Si" *J. Electrochem. Soc.: Solid State Science*, 114 (2), pp. 201-204 (1967).
- Chang et al. "Small-Subthreshold-Swing and Low-Voltage Flexible Organic Thin-Film Transistors Which Use HfLaO as the Gate Dielectric," *IEEE Electron Device Letters*, Feb. 2009, pp. 133-135; vol. 30, No. 2; IEEE Electron Device Society.
- Chatterjee et al., "Sub-100nm Gate Length Metal Gate NMOS Transistors Fabricated by a Replacement by a Replacement Gate Process," *IEEE Semiconductor Process and Device Center*, 821-824 (1997).
- Chen et al., "A Self-Aligned Airgap Interconnect Scheme," *IEEE International Interconnect Technology Conference*, vol. 1-3, 146-148 (2009).
- Chen et al., "Develop Gap-fill Process of Shallow Trench Isolation in 450mm Wafer by Advanced Flowable CVD Technology for Sub-20nmNode," 2016 27th Annual Semi Advanced Semiconductor Manufacturing Conference (Asmc), IEEE, May 16, 2016, pp. 157-159 (2016).
- Cheng et al., "Effect of carrier gas on the structure and electric properties of low dielectric constant SiCOH film using trimethylsilane prepared by plasma enhanced chemical vapor deposition," *Thin Solid Films* vol. 469-470, pp. 178-183 (2004).
- Choi et al., "Improvement of Silicon Direct Bonding using Surfaces Activated by Hydrogen Plasma Treatment," *Journal of the Korean Physical Society*, 37, 6, 878-881 (2000).
- Choi et al., "Low Temperature Formation of Silicon Oxide Thin Films by Atomic Layer Deposition Using NH₃/O₂ Plasma," *ECS Solid State Letters*, 2(12) p. 114-p. 116 (2013).
- Closser et al., "Molecular Layer Deposition Of A Highly Stable Silicon Oxycarbide Thin Film Using An Organic Chlorosilane And Water," *ACS Applied Materials & Interfaces* 10, pp. 24266-24274 (2018).
- Coates, "Process Analytical Technology: Spectroscopic Tools and Implementation Strategies for the Chemical and Pharmaceutical Industries." Blackwell Publishing Ltd, 91-132, (2005).
- Conroy et al., "The Preparation and Properties of Single Crystals of the 1S and 2S Polymorphs of Tantalum Disulfide" *J. Solid State Chemistry*, 4, pp. 345-350 (1972).
- Crowell, "Chemical methods of thin film deposition: Chemical vapor deposition, atomic layer deposition, and related technologies," *Journal of Vacuum Science & Technology A* 21.5, (2003): S88-S95.
- Cui et al., "Impact of Reductive N₂/H₂ Plasma on Porous Low-Dielectric Constant SiCOH Thin Films," *Journal of Applied Physics* 97, 113302, 1-8 (2005).
- De Silva et al., "Inorganic Hardmask Development For Extreme Ultraviolet Patterning," *Journal of Micro/Nanolithography, MEMS, and MOEMS* 18(1) (2018).
- Dingemans et al., "Comparison Between Aluminum Oxide Surface Passivation Films Deposited with Thermal Aid," *Plasma Aid and Pevcd*, 35th IEEE PVCS, (Jun. 2010).
- Drummond et al., "Hydrophobic Radiofrequency Plasma-Deposited Polymer Films: Dielectric Properties and Surface Forces," *Colloids and Surfaces A*, 129-130, 117-129 (2006).
- Duffey et al., "Raman Scattering from 1T-TaS₂" *Solid State Communications* 20, pp. 617-621 (1976).
- Easley et al., "Thermal Isolation of Microchip Reaction Chambers for Rapid Non-Contact DNA Amplification," *J. Micromech. Microeng.* 17, 1758-1766 (2007).
- Elam et al., "New Insights into Sequential Infiltration Synthesis", *ECS Transactions*, vol. 69, pp. 147-157 (2015).
- Elers et al. "Film Uniformity in Atomic Layer Deposition," *Chemical Vapor Deposition*, 12, pp. 13-24 (2006).
- Fu et al., "Controlled Synthesis of Atomically Thin 1T-TaS₂ for Tunable Charge Density Wave Phase Transitions" *Chem. Mater.* 28, pp. 7613-7618 (2016).
- Ge et al., "Carbon Nanotube-Based Synthetic Gecko Tapes," *Department of Polymer Science, PNAS*, 10792-10795 (2007).
- George et al., "Atomic Layer Deposition: An Overview," *Chem. Rev.* 110, 111-131 (2010).
- Gesheva et al. "Composition and Micro structure of Black Molybdenum Photothermal Converter Layers Deposited by the Pyrolytic Hydrogen Reduction of MoO₂Cl₂" *Thin Solid Films*, 79, pp. 39-49 (1981).
- Gole et al. "Preparation of Nickel Sulfide Thin Films and Nanocrystallites Using Nickel Furfuraldehyde Thiosemicarbazone as Single-source Precursor," *Advanced Materials Research*, vols. 383-390, pp. 3828-3834 (2012).

(56)

References Cited

OTHER PUBLICATIONS

- Grill et al., "The Effect of Plasma Chemistry on the Damage Induced Porous SiCOH Dielectrics," IBM Research Division, RC23683 (W0508-008), Materials Science, 1-19 (2005).
- Guan et al., "Voltage gated ion and molecule transport in engineered nanochannels: theory, fabrication and applications," *Nanotechnology* 25 (2014) 122001.
- Gupta et al., "Charge carrier transport and electroluminescence in atomic layer deposited poly-GaN/c-Si heterojunction diodes," *Journal of Applied Physics*, 124, 084503 (2018).
- Gupta et al., "Conversion of Metal Carbides to Carbide Derived Carbon by Reactive Ion Etching in Halogen Gas," *Proceedings of SPIE—The International Society for Optical Engineering and Nanotechnologies for Space Applications*, ISSN: 0277-786X (2006).
- Habib et al., "Atmospheric oxygen plasma activation of silicon (100) surfaces," *American Vacuum Society*, 28(3), pp. 476-485 (2010).
- Han et al., "van der Waals Metallic Transition Metal Dichalcogenides" *Chem. Rev.* 118, pp. 6297-6336 (2018).
- Harrison et al., "Poly-gate Replacement Through Contact Hole (PRETCH): A New Method for High-K/ Metal Gate and Multi-Oxide Implementation on Chip," *IEEE* (2004).
- Heo et al., "Structural Characterization of Nanoporous Low-Dielectric Constant SiCOH Films Using Organosilane Precursors," *NSTI—Nanotech*, vol. 4, 122-123 (2007).
- Henke et al., "X-Ray Interactions: Photo absorption, Scattering, Transmission, and Reflection at E=50-30,000 eV, Z=1-92," *Atomic Data and Nuclear Data Tables*, 54, 181-342 (1993).
- Heyne et al., "The conversion mechanism of amorphous silicon to stoichiometric WS₂" *J. Materials Chemistry C*, 6, pp. 4122-4130 (2018).
- Hossain et al., "Recent Advances in Two-Dimensional Materials with Charge Density Waves: Synthesis, Characterization and Applications" *Crystals* 7, 298, 19 pages (2017).
- Hubert et al., "A Stacked SONOS Technology, up to 4 Levels and 6nm Crystalline Nanowires, With Gate-All-Around or Independent Gates (-Flash), Suitable for Full 3D Integration," *Minattec, IEDM09-637-640* (2009).
- Hudis, "Surface Crosslinking of Polyethylene Using a Hydrogen Glow Discharge," *J. Appl. Polym. Sci.*, 16 (1972) 2397.
- Johansson et al., "Towards absolute asymmetric synthesis. Synthesis and crystal structure of stereochemically labile MCl₂ (M=Co, Ni, Cu, Zn) complexes with diamine ligands," *Inorganica Chimica Acta* 358, pp. 3293-3302 (2005).
- Jones et al., "Growth of Aluminum Films by Low Pressure Chemical Vapour Deposition Using Tertiarybutylaluminium," *Journal of Crystal Growth* 135, pp. 285-289, Elsevier Science B.V. (1994).
- Jones et al., "Recent Developments in Metalorganic Precursors for Metalorganic Chemical Vapour Deposition," *Journal of Crystal Growth* 146, pp. 503-510, Elsevier Science B.V. (1995).
- Jung et al., "Double Patterning of Contact Array with Carbon Polymer," *Proc. of SPIE*, 6924, 69240C, 1-10 (2008).
- Jung et al., "New Mechanisms for Ozone-Based ALO Growth of High-k Dielectrics via Nitrogen-Oxygen Species" *ECS Transactions*, 33(2), pp. 91-99 (2010).
- Katamreddy et al., "ALD and Characterization of Aluminum Oxide Deposited on Si(100) using Tris(diethylamino) Aluminum and Water Vapor," *Journal of The Electrochemical Society*, 153 (10) C701-C706 (2006).
- Kern et al., "Chemically Vapor-Deposited Borophosphosilicate Glasses for Silicon Device Applications" *RCE Review*, 43, 3, pp. 423-457 (1982).
- Kerrigan et al., "Low Temperature, Selective Atomic Layer Deposition of Cobalt Metal Films Using Bis(1,4-di-tert-butyl-1,3-diazadienyl)cobalt and Alkylamine Precursors," *Chem. Materials*, 29, pp. 7458-7466 (2017).
- Kim et al., "Passivation Effect on Low-k S/OC Dielectrics by H₂ Plasma Treatment," *Journal of the Korean Physical Society*, "40, 1, 94-98 (2002).
- Kim et al., "Characteristics of Low Temperature High Quality Silicon Oxide by Plasma Enhanced Atomic Layer Deposition with In-Situ Plasma Densification Process," *The Electrochemical Society, ECS Transactions, College of Information and Communication Engineering, Sungkyunkwan University*, 53(1), 321-329 (2013).
- Kim et al., "Novel Flowable CVD Process Technology for sub-20nm Interlayer Dielectrics," *IEEE International Interconnect Technology Conference (IITC 2012)*, San Jose, California, USA, Jun. 4-6, 2012, pp. 1-3 (2012).
- King, Plasma Enhanced Atomic Layer Deposition of SiN_x: H and SiO₂, *J. Vac. Sci. Technol.*, A29(4) (2011).
- Klug et al., "Atomic Layer Deposition of Amorphous Niobium Carbide-Based Thin Film Superconductors," *The Journal of Physical Chemistry C*, vol. 115, pp. 25063-25071, (2011).
- Kobayshi, et al., "Temperature Dependence of SiO₂ Film Growth with Plasma-Enhanced Atomic Layer Deposition," regarding Thin Solid Films, published by Elsevier in the International Journal on the Science and Technology of Condensed Matter, in vol. 520, No. 11, 3994-3998 (2012).
- Kogelschatz et al., "Ozone Generation from Oxygen and Air: Discharge Physics And Reaction Mechanisms" *Ozone Science & Engineering*, 10, pp. 367-378 (1998).
- Koo et al., "Characteristics of Al₂O₃ Thin Films Deposited Using Dimethylaluminum Isopropoxide and Trimethylaluminum Precursors by the Plasma-Enhanced Atomic-Layer Deposition Method," *Journal of Physical Society*, 48, 1, 131-136 (2006).
- Koutsokeras et al., "Texture and Microstructure Evolution in Single-Phase TixTaly-xN Alloys of Rocksalt Structure," *Journal of Applied Physics*, 110, pp. 043535-1-043535-6, (2011).
- Knoops et al., "Atomic Layer Deposition of Silicon Nitride from Bis(tert-butylamino) silane and N₂ Plasma," *Applied Materials & Interfaces, American Chemical Society*, A-E (2015).
- Krenek et al., "IR Laser CVD of Nanodisperse Ge—Si—Sn Alloys Obtained by Dielectric Breakdown of GeH₄/SiH₄/SnH₄ Mixtures", *NanoCon 2014*, Nov. 5-7, Brno, Czech Republic, EU.
- Kukli et al., "Influence of atomic layer deposition parameters on the phase content of Ta₂O₅ films" *J. Crystal Growth*, 212, pp. 459-468 (2000).
- Kukli et al., "Properties of hafnium oxide films grown by atomic layer deposition from hafnium tetraiodide and oxygen". *Journal of Applied Physics*, vol. 92, No. 10, Nov. 15, 2002, pp. 5698-5703.
- Kukli et al., "Properties of tantalum oxide thin films grown by atomic layer deposition" *Thin Solid Films*, 260, pp. 135-142 (1995).
- Kurosawa et al., "Synthesis and Characterization of Plasma-Polymerized Hexamethyldisiloxane Films," *Thin Solid Films*, 506-507, 176-179 (2006).
- Kwon et al., "Substrate Selectivity of (tBu-Allyl)Co(CO)₃ during Thermal Atomic Layer Deposition of Cobalt," *Chem. Materials*, 24, pp. 1025-1030 (2012).
- Lanford et al., "The Hydrogen Content of Plasmadeposited Silicon Nitride," *J. Appl. Phys.*, 49, 2473 (1978).
- Lee et al., "Characteristics Of Low-K Sioc Films Deposited Via Atomic Layer Deposition," *Thin Solid Films* 645, pp. 334-339 (2018).
- Lee et al., Layer Selection by Multi-Level Permutation in 3-D Stacked NAND Flash Memory, *IEEE Electron Device Letters*, vol. 37, No. 7, 866-869 (2016).
- Levy et al., "Reflow Mechanisms of Contact Vias in VLSI Processing" *J. Electrochem. Soc.: Solid-State Science and Technology*, 133, 7, pp. 1417-1424 (1986).
- Li et al., "Metallic Transition-Metal Dichalcogenide Nanocatalysts for Energy Conversion" *Chem.* 4, pp. 1510-1537 (2018).
- Liang et al., "Conversion of Metal Carbides to Carbide Derived Carbon by Reactive Ion Etching in Halogen Gas" *Micro (MEMS) and Nanotechnologies for Space Applications*, Thomas George et al. vol. 6223, 2006 p. 62230J-I to 62230J-11 lines 3-14 in the "Abstract" section and lines 7-9 in the "Introduction" section of p. 1, lines 3-4 in the "Introduction" section and lines 3-4 in the "Experimental Procedure" section of p. 2.
- Lieberman, et al., "Principles of Plasma Discharges and Materials Processing," Second Edition, 368-381 (2005).
- Lim et al., "Low-Temperature Growth of SiO₂ Films by Plasma-Enhanced Atomic Layer Deposition," *ETRI Journal*, 27 (1), 118-121 (2005).

(56)

References Cited

OTHER PUBLICATIONS

- Lim et al. "Synthesis and Characterization of Volatile, Thermally Stable, Reactive Transition Metal Amidinates," *Inorg. Chem.*, 42, pp. 7951-7958 (2003).
- Liu et al., "Research, Design, and Experiment of End Effector for Wafer Transfer Robot," *Industrial Robot: An International Journal*, 79-91 (2012).
- Liu et al., "Van der Waals metal-semiconductor junction: Weak Fermi level pinning enables effective tuning of Schottky barrier" *Sci. Adv.* 2: e1600069, 7 pages (2016).
- Longrie et al., "Plasma-Enhanced ALD of Platinum with O₂, N₂ and NH₃ Plasmas", *ECS Journal of Solid State Science and Technology*, vol. 1, pp. Q123-Q129 (2012).
- MacKenzie et al. "Stress Control of Si-Based PEVCD Dielectrics," *Proc. Symp. Silicon Nitride and Silicon Dioxide Thin Insulating Films & Other Emerging Dielectrics VIII*, 148-159 (2005).
- Mackus et al., "Optical Emission Spectroscopy as a Tool for Studying Optimizing and Monitoring Plasma-Assisted Atomic Layer Deposition Processes," *Journal of Vacuum Science and Technology*, 77-87 (2010).
- Maeno, "Gecko Tape Using Carbon Nanotubes," *Nitto Denko Gihou*, 47, 48-51 (2009).
- Maeng et al. Electrical properties of atomic layer disposition HfO₂ and HfO_xNy on Si substrates with various crystal orientations, *Journal of the Electrochemical Society*, Apr. 2008, p. H267-H271, vol. 155, No. 4, Department of Materials Science and Engineering, Pohang University of Science and Technology, Pohang, Korea.
- Makela et al. "Thermal Atomic Layer Deposition of Continuous and Highly Conducting Gold Thin Films," *Chem. Materials*, 29, pp. 6130-6136 (2017).
- Marsik et al., "Effect of Ultraviolet Curing Wavelength on Low-k Dielectric Material Properties and Plasma Damage Resistance," *Sciencedirect.com*, 519, 11, 3619-3626 (2011).
- Mason et al., "Hydrolysis of Tri-tert-butylaluminum: The First Structural Characterization of Alkylaluminumoxanes [(R₂Al)₂O]_n and (RAIO)_n," *J. American Chemical Society*, vol. 115, No. 12, pp. 4971-4984 (1993).
- Massachusetts Institute of Technology Lincoln Laboratory, "Solid State Research," *Quarterly Technical Report* (1995).
- Mattinen et al., "Crystalline tungsten sulfide thin films by atomic layer deposition and mild annealing" *J. Vac. Sci. Tech.* 37, 020921, 35 pages (2019).
- Maydannik et al., "Spatial atomic layer deposition: Performance of low temperature H₂O and O₃ oxidant chemistry for flexible electronics encapsulation", *Journal of Vacuum Science and Technology: Part A AVS/ AIP*, vol. 33 (1901).
- Meng et al., "Atomic Layer of Deposition of Silicon Nitride Thin Films: A Review of Recent Progress, Challenges, and Outlooks," *Materials*, 9, 1007 (2016).
- Mix et al., "Characterization of plasma-polymerized allyl alcohol polymers and copolymers with styrene," *Adhes. Sci. Technol.*, 21 (2007), S. 487-507.
- Moeen, "Design, Modelling and Characterization of Si/SiGe Structures for IR Bolometer Applications," *KTH Royal Institute of Technology. Information and Communication Technology, Department of Integrated Devices and Circuits, Stockholm Sweden* (2015).
- Morishige et al., "Thermal Desorption and Infrared Studies of Ammonia Amines and Pyridines Chemisorbed on Chromic Oxide," *J. Chem. Soc., Faraday Trans. 1*, 78, 2947-2957 (1982).
- Mosleh et al., "Enhancement of Material Quality of (Si)GeSn Films Grown by SnCl₄ Precursor," *ECS Transactions*, 69 (5), 279-285 (2015).
- Mukai et al., "A Study of CD Budget in Spacer Patterning Technology," *Proc. of SPIE*, 6924, 1-8 (2008).
- Nakano et al., "Layer-by-Layer Epitaxial Growth of Scalable WSe₂ on Sapphire by Molecular Beam Epitaxy" *Nano. Lett.* 17, pp. 5595-5599 (2017).
- Ngo et al. "Atomic layer deposition of photoactive CoO/SrTiO₃ and CoO/TiO₂ on Si(001) for visible light driven photoelectrochemical water oxidation," *J. Applied Physics*, 114, 9 pages (2013).
- Nogueira et al., "Production of Highly Hydrophobic Films Using Low Frequency and High Density Plasma," *Revista Brasileira de Aplicacoes de Vacuo*, 25(1), 45-53 (2006).
- Novaro et al. Theoretical Study on a Reaction Pathway of Ziegler-Natta-Type Catalysis, *J. Chem. Phys.* 68(5), Mar. 1, 1978 p. 2337-2351.
- Ohchi et al. "Reducing damage to Si substrates during gate etching processes." *Japanese Journal of Applied Physics* 47.7R 5324 (2008).
- Okamoto et al., "Luminescent Properties of Pr³⁺-sensitized LaPO₄: Gd³⁺ Ultraviolet-B Phosphor Under Vacuum-Ultraviolet Light Excitation," *J. App. Phys.* 106, 013522 (2009).
- Park, "Substituted Aluminum Metal Gate on High-K Dielectric for Low Work-Function and Fermi-Level Pinning Free," 4 pages, *IEEE 0-7803-8684-1/04* (2004).
- Peters et al., "Aerosol-Assisted Chemical Vapor Deposition of NbS₂ and TaS₂ Thin Films from Pentakis(dimethylamido)metal Complexes and 2-Methylpropanethiol" *Eur. J. Inorg. Chem.*, pp. 4179-4185 (2005).
- Portet et al., "Impact of Synthesis Conditions on Surface Chemistry and Structure of Carbide-Derived Carbons," *Thermochimica Acta*, 497, 137-142 (2010).
- Potts et al., "Low Temperature Plasma-Enhanced Atomic Layer Deposition of metal Oxide Thin Films," *Journal of the Electrochemical Society*, 157, 66-74 (2010).
- Potts et al., "Room-Temperature ALD of Metal Oxide Thin Films by Energy-Enhanced ALD", *Chemical Vapor Deposition*, vol. 19, pp. 125-133 (2013).
- Presser, et al., "Effect of Pore Size on Carbon Dioxide Sorption by Carbide Derived Carbon," *Energy & Environmental Science* 4.8, 3059-3066 (2011).
- Provine et al., "Correlation of Film Density and Wet Etch Rate in Hydrofluoric Acid of Plasma Enhanced Atomic Layer Deposited Silicon Nitride," *AIP Advances*, 6 (2016).
- Radamson et al. "Growth of Sn-alloyed Group IV Materials for Photonic and Electronic Applications" Chapter 5 pp. 129-144, *Manufacturing Nano Structures* (2014).
- Ryu et al., "Persistent Charge-Density-Wave Order in Single-Layer TaSe₂" *Nano. Lett.* 18, pp. 689-694 (2018).
- Sakuma et al., "Highly Scalable Horizontal Channel 3-D NAND Memory Excellent in Compatibility with Conventional Fabrication Technology," *IEEE Electron Device Letters*, vol. 34, No. 9, 1142-1144 (2013).
- Salim, "In-situ Fourier Transform Infrared Spectroscopy of Chemistry and Growth in Chemical Vapor Deposition," *Massachusetts Institute of Technology*, 187 pages (1995).
- Salim et al., "In Situ Concentration Monitoring in a Vertical OMVPE Reactor by Fiber-Optics-Based Fourier Transform Infrared Spectroscopy," *Journal of Crystal Growth* 169, pp. 443-449, Elsevier Science B.V. (1996).
- Samal et al., "Low-Temperature (<200° C.) Plasma Enhanced Atomic Deposition of Dense Titanium Nitride Thin Films" (2012).
- Sanders et al., "Crystalline and electronic structure of single-layer TaS₂" *Phys. Rev. B.* 94, 081404, 6 pages (2016).
- Schindler, Dissertation, Next Generation High-k Dielectrics for DRAM Produced by Atomic Layer Deposition Studied by Transmission Electron Microscopy (2015).
- Schmatz et al., "Unusual Isomerization Reactions in 1,3-Diaza-2-Silicyclopentanes," *Organometallics*, 23, 1180-1182 (2004).
- Sellers, Making Your Own Timber Dogs, Paul Sellers blog, Published on Nov. 18, 2014, [online], [site visited Jun. 10, 2017], Available from Internet, <URL: <https://paulsellers.com/2014/11/making-your-own-timber-dogs/>>.
- Selvaraj et al., "Selective Atomic Layer Deposition of Zirconia on Copper Patterned Silicon Substrates Using Ethanol as Oxygen Source as Well as Copper Reductant," *J. Vac. Sci. Technol.* A32(1), (2014).
- Selvaraj et al., "Surface Selective Atomic Layer Deposition of Hafnium Oxide for Copper Diffusion Barrier Application Using Tetrakis (diethylamino) Hafnium and Ethanol," 225th ECS Meeting, Meeting Abstract, (May 12, 2014).
- Seshadri et al., "Ultrathin Extreme Ultraviolet Patterning Stack Using Polymer Brush As An Adhesion Promotion Layer," *Journal of Micro/Nanolithography, MEMS, and MOEMS* 16(3) (2017).

(56)

References Cited

OTHER PUBLICATIONS

- Shamma et al., "PDL Oxide Enabled Doubling," Proc. Of SPIE, 6924, 69240D, 1-10 (2008).
- Simchi et al., "Sulfidation of 2D transition metals (Mo, W, Re, Nb, Ta): thermodynamics, processing, and characterization" J. Materials Science 52: 17, 9 pages (2017).
- Stanley et al. "Feedgas for Modern High-Performance Ozone Generators" Ozonia Ltd., Duebendorf, Switzerland. 7 pages. Available Jul. 14, 2017 online at: http://www.degremont-technologies.com/cms_medias/pdf/tech_ozonia_feedgas.pdf (1999).
- Svetin et al., "Three-dimensional resistivity and switching between correlated electronic states in 1T-TaS₂" Nature, Scientific Reports Apr. 12, 2017, 7:46048, 10 pages (2017).
- Tatehaba et al., "Adhesion Energy of Polystyrene and Substrate in Function Water," 5th International Symposium of Cleaning Technology in Semiconductor Device Manufacturing, pp. 560-565 (1998).
- Todi et al., "Characterization of Pt—Ru Binary Alloy Thin Films for Work Function Tuning," IEEE Electron Device Letters, vol. 27, No. 7, pp. 542-545 (2006).
- Tseng et al., "Etch Properties of Resists Modified by Sequential Infiltration Synthesis," American Vacuum Society (2011).
- Tseng et al., "Enhanced Block Copolymer Lithography Using Sequential Infiltration Synthesis," Journal of Physical Chemistry, vol. 5, 17725-17729 (2011).
- Ueda et al. "Enhanced Sidewall Grown (ESG) process: towards PEALD with conformality above 100%," Extended Abstracts of the 2011 International Conference on Solid State Devices and Materials, Nagoya, pp. 34-35 (2011).
- Varma, et al., "Effect of Metal Halides on Thermal, Mechanical, and Electrical Properties of Polypyromellitimide Films," Journal of Applied Polymer Science, vol. 32, pp. 3987-4000, (1986).
- Vasilev, "Borophosphosilicate Glass Films in Silicon Microelectronics, Part 1: Chemical Vapor Deposition, Composition, and Properties" Russian Microelectronics, vol. 33, No. 5, pp. 271-284 (2004).
- Voltaix, "Material Safety Data Sheet for: Trisilylamine", pp. 1-8, (2014).
- Wang et al., "Tertiarybutylaluminum as an Organometallic Source for Epitaxial Growth of AlGaSb," Appl. Phys. Lett. 67 (10), Sep. 4, pp. 1384-1386, American Institute of Physics (1995).
- Wirths, et al., "SiGeSn Growth studies Using Reduced Pressure Chemical Vapor Deposition Towards Optoelectronic Applications," Thin Solid Films, 557, 183-187 (2014).
- Xing et al., "Ising Superconductivity and Quantum Phase Transition in Macro-Size Monolayer NbSe₂" Nano. Lett. 17, pp. 6802-6807 (2017).
- Xu et al., "14NM Metal Gate Film Stack Development and Challenges," Smic et al. (2016).
- Xu et al., "Contacts between Two- and Three-Dimensional Materials: Ohmic, Schottky, and p-n Heterojunctions" ACS Nano 10, pp. 4895-4919 (2016).
- Yoshida, et al., Threshold Voltage Tuning for 10NM and Beyond CMOS Integration, Solid State Technology, 57(7): 23-25 (2014).
- Yu et al., "Modulation of the Ni FUSI Workfunction by Yb Doping: from Midgap to N-Type Band-Edge," 4 pages, IEEE 0-7803-9269-8/05 (2005).
- Yuan et al., "Facile Synthesis of Single Crystal Vanadium Disulfide Nanosheets by Chemical Vapor Deposition for Efficient Hydrogen Evolution Reaction" Adv. Mater. 27, pp. 5605-5609 (2015).
- Yun et al., "Behavior of Various Organosilicon Molecules in PECVD Processes for Hydrocarbon-Doped Silicon Oxide Films," Solid State Phenomena, vol. 124-126, 347-350 (2007).
- Yun et al., "Comparison of Atomic Scale Etching of Poly-Si in Inductively Coupled Ar and He Plasmas", Korean Journal of Chemical Engineering, vol. 24, 670-673 (2007).
- Yun et al., "Single-Crystalline Si Stacked Array (STAR) NAND Flash Memory," IEEE Transactions on Electron Devices, vol. 58, No. 4, 1006-1014 (2011).
- Yun et al., "Effect of Plasma on Characteristics of Zirconium Oxide Films Deposited by Plasma-Enhanced Atomic Layer Deposition," Electrochemical and Solid State Letters, 8(11) F47-F50 (2005).
- Yushin et al., "Carbon-Derived Carbon," Department of Materials Science and Engineering, Taylor & Francis Group, LLC (2006).
- Zhou et al., "A library of atomically thin metal chalcogenides" Nature 556, pp. 355-361 (2018).
- Chemistry Stack Exchange, "Why is CF₄ Non-Polar and CHF₃ Polar," <https://chemistry.stackexchange.com/questions/31604/why-is-cf4-non-polar-and-chf3-polar>, (2015).
- Crystal IS "Application Note: Using UV Reflective Materials to Maximize Disinfection"; AN011; Jun. 16, 2016.
- "Polyurethane_HF"; webpage; no date. Cited in Notice of References dated May 18, 2017 in U.S. Appl. No. 14/884,695.
- Scientific and Technical Information Center EIC 2800 Search Report dated Feb. 16, 2012.
- EPO; Notice of Allowance dated Oct. 16, 2019 in Application No. 09836647.9.
- KIPO; Notice of Allowance dated Sep. 27, 2019 in Application No. 10-2012-7004062.
- KIPO; Office Action dated Nov. 27, 2019 in Application No. 10-2013-0050740.
- KIPO; Office Action dated Nov. 12, 2019 in Application No. 10-2013-0102026.
- KIPO; Notice of Allowance dated Oct. 21, 2019 in Application No. 10-2013-0109390.
- KIPO; Notice of Allowance dated Oct. 28, 2019 in Application No. 10-2013-0121554.
- KIPO; Notice of Allowance dated Nov. 29, 2019 in Application No. 10-2019-0127773.
- TIPO; Office Action dated Nov. 6, 2019 in Application No. 105101537.
- TIPO; Office Action dated Oct. 1, 2019 in Application No. 105114105.
- TIPO; Office Action dated Oct. 3, 2019 in Application No. 105119533.
- TIPO; Office Action dated Oct. 28, 2019 in Application No. 105122715.
- USPTO; Non-Final Office Action dated Oct. 31, 2019 in U.S. Appl. No. 14/457,058.
- USPTO; Advisory Action dated Oct. 28, 2019 in U.S. Appl. No. 14/508,489.
- USPTO; Notice of Allowance dated Nov. 14, 2019 in U.S. Appl. No. 14/793,323.
- USPTO; Final Office Action dated Oct. 24, 2019 in U.S. Appl. No. 15/135,258.
- USPTO; Advisory Action dated Oct. 22, 2019 in U.S. Appl. No. 15/205,827.
- USPTO; Non-Final Office Action dated Nov. 7, 2019 in U.S. Appl. No. 15/377,439.
- USPTO; Final Office Action dated Sep. 18, 2019 in U.S. Appl. No. 15/380,921.
- USPTO; Non-Final Office Action dated Oct. 24, 2019 in U.S. Appl. No. 15/402,993.
- USPTO; Notice of Allowance dated Oct. 7, 2019 in U.S. Appl. No. 15/489,453.
- USPTO; Non-Final Office Action dated Oct. 3, 2019 in U.S. Appl. No. 15/491,726.
- USPTO; Advisory Action dated Sep. 20, 2019 in U.S. Appl. No. 15/589,861.
- USPTO; Final Office Action dated Nov. 12, 2019 in U.S. Appl. No. 15/636,307.
- USPTO; Notice of Allowance dated Nov. 7, 2019 in U.S. Appl. No. 15/660,797.
- USPTO; Non-Final Office Action dated Oct. 10, 2019 in U.S. Appl. No. 15/672,096.
- USPTO; Advisory Action dated Sep. 23, 2019 in U.S. Appl. No. 15/672,119.
- USPTO; Non-Final Office Action dated Nov. 20, 2019 in U.S. Appl. No. 15/690,017.
- USPTO; Notice of Allowance dated Nov. 7, 2019 in U.S. Appl. No. 15/707,786.
- USPTO; Non-Final Office Action dated Sep. 26, 2019 in U.S. Appl. No. 15/727,432.
- USPTO; Non-Final Office Action dated Nov. 20, 2019 in U.S. Appl. No. 15/795,056.

(56)

References Cited

OTHER PUBLICATIONS

- USPTO; Non-Final Office Action dated Nov. 15, 2019 in U.S. Appl. No. 15/802,154.
- USPTO; Final Office Action dated Nov. 13, 2019 in U.S. Appl. No. 15/860,564.
- USPTO; Advisory Action dated Nov. 5, 2019 in U.S. Appl. No. 15/879,209.
- USPTO; Non-Final Office Action dated Oct. 24, 2019 in U.S. Appl. No. 15/890,037.
- USPTO; Final Office Action dated Nov. 19, 2019 in U.S. Appl. No. 15/896,986.
- USPTO; Non-Final Office Action dated Jul. 25, 2019 in U.S. Appl. No. 16/039,867.
- USPTO; Notice of Allowance dated Oct. 3, 2019 in U.S. Appl. No. 16/200,100.
- USPTO; Non-Final Office Action dated Sep. 24, 2019 in U.S. Appl. No. 16/251,534.
- USPTO; Notice of Allowance dated Oct. 30, 2019 in U.S. Appl. No. 29/604,101.
- USPTO; Final Office Action dated Jul. 15, 2019 in U.S. Appl. No. 29/646,377.
- USPTO; Notice of Allowance dated Nov. 14, 2019 in U.S. Appl. No. 29/646,377.
- Ellis et al. "Nitrous Oxide (N₂O) Processing for Silicon Oxynitride Gate Dielectrics." IBM Journal of Research and Development. 1999. 43 [3], pp. 287-300. (1999).
- Hayashi et al. "Spectroscopic properties of nitrogen doped hydrogenated amorphous carbon films grown by radio frequency plasma-enhanced chemical vapor deposition," Journal of Applied Physics, vol. 89, No. 12, pp. 7924-7931 (2001).
- Miller et al. "Carbon nitrides: synthesis and characterization of a new class of functional materials," Phys.Chem.Chem.Phys., 19, pp. 15613-15638 (2017).
- Ohtsu et al. "Influences of Gap Distance on Plasma Characteristics in Narrow Gap Capacitively Coupled Radio-Frequency Discharge," vol. 43, No. 2, pp. 795-799 (2004).
- CNIPA; Office Action dated Oct. 16, 2020 in Application No. 201610131743.1.
- CNIPA; Office Action dated Jun. 16, 2020 in Application No. 201610897958.4.
- CNIPA; Office Action dated Jul. 3, 2020 in Application No. 201610898822.5.
- CNIPA; Notice of Allowance dated Oct. 9, 2020 in Application No. 201610898822.5.
- CNIPA; Notice of Allowance dated Nov. 4, 2020 in Application No. 201710173292.2.
- CNIPA; Office Action dated Aug. 31, 2020 in Application No. 201780044761.9.
- CNIPA; Office Action dated Apr. 27, 2020 in Application No. 201810379112.0.
- CNIPA; Office Action dated Apr. 27, 2020 in Application No. 201810836604.8.
- CNIPA; Office Action dated Jul. 30, 2020 in Application No. 201810836604.8.
- CNIPA; Office Action dated Apr. 22, 2020 in Application No. 201810994464.7.
- CNIPA; Notice of Allowance dated Aug. 7, 2020 in Application No. 202030053609.1.
- EPO; Office Action dated Jul. 29, 2008 in Application No. 00902194.0.
- EPO; Office Action dated Jun. 27, 2003 in Application No. 97929595.3.
- EPO; Office Action dated Feb. 18, 2004 in Application No. 97929595.3.
- EPO; Notice of Allowance dated Apr. 29, 2004 in Application No. 97929595.3.
- EPO; Notice of Allowance dated Jan. 10, 2001 in Application No. 98911263.6.
- EPO; Office Action dated Jun. 6, 2001 in Application No. 98911277.6.
- EPO; Office Action dated Jun. 27, 2003 in Application No. 98967122.7.
- EPO; Notice of Allowance dated Feb. 23, 2004 in Application No. 98967122.7.
- EPO; Office Action dated Sep. 22, 2003 in Application No. 99946447.2.
- EPO; Office Action dated Nov. 25, 2003 in Application No. 99946447.2.
- EPO; Office Action dated Mar. 30, 2004 in Application No. 99946447.2.
- EPO; Office Action dated Jul. 19, 2004 in Application No. 99946447.2.
- EPO; Notice of Allowance dated Sep. 22, 2004 in Application No. 99946447.2.
- EPO; Supplementary European Search Report dated May 27, 2002 in Application No. 99973123.
- EPO; Notice of Allowance dated Jun. 11, 2004 in Application No. 99973123.
- JPO; Office Action dated Jun. 1, 2020 in Application No. 2016-206625.
- JPO; Office Action dated Aug. 28, 2020 in Application No. 2017-139817.
- JPO; Notice of Allowance dated Jul. 1, 2020 in Application No. 2019-025168.
- JPO; Office Action dated Aug. 24, 2020 in Application No. 2019-119908.
- JPO; Office Action dated Jun. 29, 2020 in Application No. 2020-502653.
- KIPO; Decision of Intellectual Property Trial and Appeal Board dated Jun. 23, 2020 in Application No. 10-2012-0076564.
- KIPO; Notice of Allowance dated Sep. 25, 2020 in Application No. 10-2013-0049598.
- KIPO; Notice of Allowance dated Aug. 13, 2020 in Application No. 10-2013-0098575.
- KIPO; Notice of Allowance dated Oct. 27, 2020 in Application No. 10-2014-0011764.
- KIPO; Office Action dated Jul. 21, 2020 in Application No. 10-2014-0011765.
- KIPO; Notice of Allowance dated Sep. 8, 2020 in Application No. 10-2014-0021615.
- KIPO; Office Action dated Oct. 26, 2020 in Application No. 10-2014-0027217.
- KIPO; Notice of Allowance dated Oct. 12, 2020 in Application No. 10-2014-0027305.
- KIPO; Office Action dated Jul. 9, 2020 in Application No. 10-2014-0060120.
- KIPO; Office Action dated Aug. 18, 2020 in Application No. 10-2014-0071653.
- KIPO; Notice of Allowance dated Oct. 19, 2020 in Application No. 10-2014-0086902.
- KIPO; Notice of Allowance dated Sep. 27, 2020 in Application No. 10-2014-0091092.
- KIPO; Office Action dated Oct. 5, 2020 in Application No. 10-2014-0103853.
- KIPO; Office Action dated Oct. 7, 2020 in Application No. 10-2014-0128626.
- KIPO; Office Action dated Jul. 21, 2020 in Application No. 10-2017-0087308.
- KIPO; Notice of Allowance dated Oct. 26, 2020 in Application No. 10-2017-0087308.
- KIPO; Office Action dated Jun. 30, 2020 in Application No. 10-2019-0044213.
- KIPO; Notice of Allowance dated Oct. 28, 2020 in Application No. 10-2020-0009462.
- KIPO; Notice of Allowance dated Jul. 20, 2020 in Application No. 10-2020-7000992.
- KIPO; Notice of Allowance dated Oct. 20, 2020 in Application No. 30-2019-0054013 M001.
- KIPO; Notice of Allowance dated Oct. 20, 2020 in Application No. 30-2019-0054013 M002.
- KIPO; Notice of Allowance dated Oct. 22, 2020 in Application No. 30-2019-0058076.

(56)

References Cited

OTHER PUBLICATIONS

- TIPO; Notice of Allowance dated Jul. 1, 2020 in Application No. 105101537.
- TIPO; Notice of Allowance dated Sep. 4, 2020 in Application No. 105111990.
- TIPO; Office Action dated Sep. 7, 2020 in Application No. 105122394.
- TIPO; Notice of Allowance dated Aug. 31, 2020 in Application No. 105122586.
- TIPO; Office Action dated Sep. 18, 2020 in Application No. 105129977.
- TIPO; Notice of Allowance dated Sep. 25, 2020 in Application No. 105130130.
- TIPO; Office Action Received Aug. 25, 2020 in Application No. 105131284.
- TIPO; Office Action dated Aug. 25, 2020 in Application No. 105131896.
- TIPO; Office Action dated Sep. 30, 2020 in Application No. 105142668.
- TIPO; Office Action dated Aug. 11, 2020 in Application No. 106100823.
- TIPO; Office Action dated Jun. 17, 2020 in Application No. 106108152.
- TIPO; Office Action dated Oct. 7, 2020 in Application No. 106108522.
- TIPO; Office Action dated Aug. 21, 2020 in Application No. 106111548.
- TIPO; Office Action dated Oct. 8, 2020 in Application No. 106111693.
- TIPO; Office Action dated Jul. 15, 2020 in Application No. 106120365.
- TIPO; Office Action dated Nov. 12, 2020 in Application No. 106120365.
- TIPO; Office Action dated Nov. 18, 2020 in Application No. 106120902.
- TIPO; Office Action dated Oct. 8, 2020 in Application No. 106123203.
- TIPO; Office Action dated Jun. 24, 2020 in Application No. 108135004.
- TIPO; Office Action dated Jun. 29, 2020 in Application No. 108137226.
- TIPO; Office Action dated Jul. 9, 2020 in Application No. 108137227.
- TIPO; Office Action dated Aug. 17, 2020 in Application No. 108139018.
- TIPO; Notice of Allowance dated Oct. 19, 2020 in Application No. 108306935.
- TIPO; Notice of Allowance dated Oct. 19, 2020 in Application No. 108306935D01.
- TIPO; Notice of Allowance dated Jul. 15, 2020 in Application No. 108307027.
- TIPO; Notice of Allowance dated Oct. 19, 2020 in Application No. 108307027D01.
- TIPO; Notice of Allowance dated Sep. 15, 2020 in Application No. 108307301.
- TIPO; Notice of Allowance dated Sep. 25, 2020 in Application No. 108307759.
- USPTO; Non-Final Office Action dated Mar. 28, 2001 in U.S. Appl. No. 09/452,844.
- USPTO; Final Office Action dated Sep. 11, 2001 in U.S. Appl. No. 09/452,844.
- USPTO; Advisory Action dated Jan. 24, 2002 in U.S. Appl. No. 09/452,844.
- USPTO; Non-Final Office Action dated Apr. 9, 2002 in U.S. Appl. No. 09/452,844.
- USPTO; Final Office Action dated Sep. 27, 2002 in U.S. Appl. No. 09/452,844.
- USPTO; Notice of Allowance dated Jun. 17, 2003 in U.S. Appl. No. 09/452,844.
- USPTO; Non-Final Office Action dated Oct. 31, 2003 in U.S. Appl. No. 09/452,844.
- USPTO; Notice of Allowance dated Mar. 26, 2004 in U.S. Appl. No. 09/452,844.
- USPTO; Non-Final Office Action dated Dec. 10, 2002 in U.S. Appl. No. 09/771,673.
- USPTO; Final Office Action dated May 29, 2003 in U.S. Appl. No. 09/771,673.
- USPTO; Final Office Action dated Feb. 6, 2004 in U.S. Appl. No. 09/771,673.
- USPTO; Advisory Action dated Apr. 20, 2004 in U.S. Appl. No. 09/771,673.
- USPTO; Notice of Allowance dated Jul. 29, 2004 in U.S. Appl. No. 09/771,673.
- USPTO; Non-Final Office Action dated Jan. 3, 2002 in U.S. Appl. No. 09/807,580.
- USPTO; Final Office Action dated Jun. 21, 2002 in U.S. Appl. No. 09/807,580.
- USPTO; Advisory Action dated Aug. 27, 2002 in U.S. Appl. No. 09/807,580.
- USPTO; Non-Final Action dated Nov. 27, 2002 in U.S. Appl. No. 09/807,580.
- USPTO; Final Office Action dated May 27, 2003 in U.S. Appl. No. 09/807,580.
- USPTO; Advisory Action dated Oct. 22, 2003 in U.S. Appl. No. 09/807,580.
- USPTO; Examiner's Answer to Appeal Brief dated May 6, 2004 in U.S. Appl. No. 09/807,580.
- USPTO; Decision on Appeal dated Feb. 16, 2005 in U.S. Appl. No. 09/807,580.
- USPTO; Non-Final Action dated May 19, 2005 in U.S. Appl. No. 09/807,580.
- USPTO; Final Action dated Nov. 21, 2005 in U.S. Appl. No. 09/807,580.
- USPTO; Notice of Allowance dated Feb. 23, 2006 in U.S. Appl. No. 09/807,580.
- USPTO; Non-Final Office Action dated Feb. 9, 2004 in U.S. Appl. No. 10/603,515.
- USPTO; Notice of Allowance dated Jun. 18, 2004 in U.S. Appl. No. 10/603,515.
- USPTO; Non-Final Office Action dated Oct. 17, 2006 in U.S. Appl. No. 10/932,633.
- USPTO; Non-Final Office Action dated Apr. 19, 2007 in U.S. Appl. No. 10/932,633.
- USPTO; Notice of Allowance dated Sep. 10, 2007 in U.S. Appl. No. 10/932,633.
- USPTO; Notice of Allowance dated Jul. 6, 2020 in U.S. Appl. No. 13/184,351.
- USPTO; Examiner's Answer to Appeal Brief dated Apr. 20, 2018 in U.S. Appl. No. 13/187,300.
- USPTO; Patent Board Decision dated Sep. 23, 2019 in U.S. Appl. No. 13/187,300.
- USPTO; Advisory Action dated Nov. 10, 2015 in U.S. Appl. No. 14/079,302.
- USPTO; Notice of Allowance dated Sep. 3, 2020 in U.S. Appl. No. 14/444,744.
- USPTO; Notice of Allowance dated Aug. 6, 2020 in U.S. Appl. No. 14/457,058.
- USPTO; Final Office Action dated Aug. 20, 2020 in U.S. Appl. No. 14/508,489.
- USPTO; Notice of Allowance dated Nov. 3, 2020 in U.S. Appl. No. 14/508,489.
- USPTO; Non-Final Office Action dated Aug. 3, 2020 in U.S. Appl. No. 14/829,565.
- USPTO; Notice of Allowance dated Aug. 18, 2020 in U.S. Appl. No. 15/135,258.
- USPTO; Non-Final Office Action dated Oct. 6, 2020 in U.S. Appl. No. 15/262,990.
- USPTO; Final Office Action dated Oct. 2, 2020 in U.S. Appl. No. 15/286,503.
- USPTO; Non-Final Office Action dated Sep. 2, 2020 in U.S. Appl. No. 15/377,439.
- USPTO; Non-Final Office Action dated Jul. 1, 2020 in U.S. Appl. No. 15/380,909.
- USPTO; Final Office Action dated Jul. 23, 2020 in U.S. Appl. No. 15/380,921.
- USPTO; Final Office Action dated Sep. 8, 2020 in U.S. Appl. No. 15/402,993.
- USPTO; Advisory Action dated Nov. 9, 2020 in U.S. Appl. No. 15/402,993.
- USPTO; Non-Final Office Action dated Sep. 30, 2020 in U.S. Appl. No. 15/491,726.

(56)

References Cited

OTHER PUBLICATIONS

- USPTO; Final Office Action dated Jul. 8, 2020 in U.S. Appl. No. 15/589,861.
- USPTO; Notice of Allowance dated Oct. 16, 2020 in U.S. Appl. No. 15/589,861.
- USPTO; Final Office Action dated Sep. 16, 2020 in U.S. Appl. No. 15/611,707.
- USPTO; Advisory Action dated Nov. 20, 2020 in U.S. Appl. No. 15/611,707.
- USPTO; Non-Final Office Action dated Sep. 3, 2020 in U.S. Appl. No. 15/636,307.
- USPTO; Notice of Allowance dated Jul. 2, 2020 in U.S. Appl. No. 15/672,096.
- USPTO; Advisory Action dated Aug. 6, 2020 in U.S. Appl. No. 15/690,017.
- USPTO; Non-Final Office Action dated Aug. 24, 2020 in U.S. Appl. No. 15/690,017.
- USPTO; Non-Final Office Action dated Oct. 6, 2020 in U.S. Appl. No. 15/691,241.
- USPTO; Final Office Action dated Sep. 24, 2020 in U.S. Appl. No. 15/726,959.
- USPTO; Non-Final Office Action dated Jul. 10, 2020 in U.S. Appl. No. 15/798,201.
- USPTO; Notice of Allowance dated Oct. 21, 2020 in U.S. Appl. No. 15/798,201.
- USPTO; Non-Final Office Action dated Jul. 2, 2020 in U.S. Appl. No. 15/802,154.
- USPTO; Notice of Allowance dated Oct. 26, 2020 in U.S. Appl. No. 15/802,154.
- USPTO; Notice of Allowance dated Sep. 30, 2020 in U.S. Appl. No. 15/815,483.
- USPTO; Final Office Action dated Sep. 17, 2020 in U.S. Appl. No. 15/835,328.
- USPTO; Final Office Action dated Aug. 6, 2020 in U.S. Appl. No. 15/835,352.
- USPTO; Notice of Allowance dated Aug. 17, 2020 in U.S. Appl. No. 15/843,899.
- USPTO; Notice of Allowance dated Jun. 30, 2020 in U.S. Appl. No. 15/860,564.
- USPTO; Notice of Allowance dated Aug. 19, 2020 in U.S. Appl. No. 15/861,418.
- USPTO; Non-Final Office Action dated Sep. 2, 2020 in U.S. Appl. No. 15/890,037.
- USPTO; Notice of Allowance dated Aug. 26, 2020 in U.S. Appl. No. 15/896,986.
- USPTO; Non-Final Office Action dated Sep. 9, 2020 in U.S. Appl. No. 15/909,705.
- USPTO; Final Office Action dated Sep. 24, 2020 in U.S. Appl. No. 15/917,224.
- USPTO; Non-Final Office Action dated Jul. 6, 2020 in U.S. Appl. No. 15/923,834.
- USPTO; Final Office Action dated Oct. 19, 2020 in U.S. Appl. No. 15/923,834.
- USPTO; Final Office Action dated Oct. 15, 2020 in U.S. Appl. No. 15/925,532.
- USPTO; Non-Final Office Action dated Oct. 6, 2020 in U.S. Appl. No. 15/940,729.
- USPTO; Non-Final Office Action dated Aug. 3, 2020 in U.S. Appl. No. 15/940,759.
- USPTO; Advisory Action dated Jul. 2, 2020 in U.S. Appl. No. 15/962,980.
- USPTO; Non-Final Office Action dated Sep. 14, 2020 in U.S. Appl. No. 15/962,980.
- USPTO; Non-Final Office Action dated Oct. 6, 2020 in U.S. Appl. No. 15/967,146.
- USPTO; Final Office Action dated Sep. 3, 2020 in U.S. Appl. No. 15/974,948.
- USPTO; Notice of Allowance dated Oct. 14, 2020 in U.S. Appl. No. 15/974,988.
- USPTO; Final Office Action dated Nov. 25, 2020 in U.S. Appl. No. 15/985,539.
- USPTO; Final Office Action dated Jul. 24, 2020 in U.S. Appl. No. 15/996,286.
- USPTO; Advisory Action dated Oct. 7, 2020 in U.S. Appl. No. 15/996,286.
- USPTO; Final Office Action dated Oct. 2, 2020 in U.S. Appl. No. 15/997,445.
- USPTO; Notice of Allowance dated Jul. 10, 2020 in U.S. Appl. No. 15/998,775.
- USPTO; Final Office Action dated Sep. 14, 2020 in U.S. Appl. No. 16/000,109.
- USPTO; Final Office Action dated Oct. 6, 2020 in U.S. Appl. No. 16/000,125.
- USPTO; Final Office Action dated Oct. 22, 2020 in U.S. Appl. No. 16/000,156.
- USPTO; Final Office Action dated Oct. 15, 2020 in U.S. Appl. No. 16/004,041.
- USPTO; Non-Final Office Action dated Sep. 8, 2020 in U.S. Appl. No. 16/039,817.
- USPTO; Non-Final Office Action dated Aug. 4, 2020 in U.S. Appl. No. 16/042,791.
- USPTO; Final Office Action dated Jul. 30, 2020 in U.S. Appl. No. 16/055,532.
- USPTO; Final Office Action dated Nov. 3, 2020 in U.S. Appl. No. 16/055,532.
- USPTO; Notice of Allowance dated Sep. 14, 2020 in U.S. Appl. No. 16/100,012.
- USPTO; Advisory Action dated Aug. 25, 2020 in U.S. Appl. No. 16/105,745.
- USPTO; Non-Final Office Action dated Nov. 25, 2020 in U.S. Appl. No. 16/105,745.
- USPTO; Advisory Action dated Jul. 8, 2020 in U.S. Appl. No. 16/105,761.
- USPTO; Non-Final Office Action dated Nov. 25, 2020 in U.S. Appl. No. 16/105,761.
- USPTO; Final Office Action dated Nov. 17, 2020 in U.S. Appl. No. 16/105,802.
- USPTO; Non-Final Office Action dated Sep. 8, 2020 in U.S. Appl. No. 16/108,950.
- USPTO; Final Office Action dated Sep. 2, 2020 in U.S. Appl. No. 16/116,708.
- USPTO; Advisory Action dated Nov. 17, 2020 in U.S. Appl. No. 16/116,708.
- USPTO; Final Office Action dated Nov. 19, 2020 in U.S. Appl. No. 16/128,282.
- USPTO; Notice of Allowance dated Aug. 5, 2020 in U.S. Appl. No. 16/130,798.
- USPTO; Advisory Action dated Aug. 24, 2020 in U.S. Appl. No. 16/132,142.
- USPTO; Non-Final Office Action dated Oct. 16, 2020 in U.S. Appl. No. 16/132,142.
- USPTO; Final Office Action dated Aug. 20, 2020 in U.S. Appl. No. 16/137,974.
- USPTO; Notice of Allowance dated Nov. 3, 2020 in U.S. Appl. No. 16/137,974.
- USPTO; Non-Final Office Action dated Jul. 30, 2020 in U.S. Appl. No. 16/151,074.
- USPTO; Advisory Action dated Sep. 16, 2020 in U.S. Appl. No. 16/152,260.
- USPTO; Final Office Action dated Jul. 15, 2020 in U.S. Appl. No. 16/152,260.
- USPTO; Non-Final Office Action dated Nov. 9, 2020 in U.S. Appl. No. 16/152,260.
- USPTO; Notice of Allowance dated Jul. 24, 2020 in U.S. Appl. No. 16/158,077.
- USPTO; Non-Final Office Action dated Jul. 23, 2020 in U.S. Appl. No. 16/167,164.
- USPTO; Non-Final Office Action dated Aug. 7, 2020 in U.S. Appl. No. 16/172,535.
- USPTO; Final Office Action dated Oct. 16, 2020 in U.S. Appl. No. 16/172,535.

(56)

References Cited

OTHER PUBLICATIONS

- USPTO; Non-Final Office Action dated Nov. 4, 2020 in U.S. Appl. No. 16/176,517.
- USPTO; Non-Final Office Action dated Oct. 29, 2020 in U.S. Appl. No. 16/183,258.
- USPTO; Notice of Allowance dated Jul. 28, 2020 in U.S. Appl. No. 16/193,789.
- USPTO; Notice of Allowance dated Jul. 7, 2020 in U.S. Appl. No. 16/194,041.
- USPTO; Final Office Action dated Nov. 27, 2020 in U.S. Appl. No. 16/205,899.
- USPTO; Non-Final Office Action dated Jul. 15, 2020 in U.S. Appl. No. 16/210,922.
- USPTO; Advisory Action dated Sep. 11, 2020 in U.S. Appl. No. 16/219,555.
- USPTO; Non-Final Office Action dated Sep. 30, 2020 in U.S. Appl. No. 16/219,555.
- USPTO; Advisory Action dated Aug. 11, 2020 in U.S. Appl. No. 16/242,829.
- USPTO; Notice of Allowance dated Sep. 23, 2020 in U.S. Appl. No. 16/242,829.
- USPTO; Non-Final Office Action dated Sep. 3, 2020 in U.S. Appl. No. 16/242,852.
- USPTO; Final Office Action dated Oct. 14, 2020 in U.S. Appl. No. 16/251,534.
- USPTO; Final Office Action dated Nov. 18, 2020 in U.S. Appl. No. 16/252,567.
- USPTO; Notice of Allowance dated Aug. 6, 2020 in U.S. Appl. No. 16/255,639.
- USPTO; Notice of Allowance dated Aug. 5, 2020 in U.S. Appl. No. 16/258,187.
- USPTO; Final Office Action dated Jun. 30, 2020 in U.S. Appl. No. 16/356,394.
- USPTO; Notice of Allowance dated Aug. 31, 2020 in U.S. Appl. No. 16/356,394.
- USPTO; Non-Final Office Action dated Aug. 5, 2020 in U.S. Appl. No. 16/397,045.
- USPTO; Non-Final Office Action dated Aug. 19, 2020 in U.S. Appl. No. 16/400,814.
- USPTO; Notice of Allowance dated Sep. 18, 2020 in U.S. Appl. No. 16/454,063.
- USPTO; Non-Final Office Action dated Nov. 27, 2020 in U.S. Appl. No. 16/468,258.
- USPTO; Non-Final Office Action dated Nov. 5, 2020 in U.S. Appl. No. 16/546,543.
- USPTO; Notice of Allowance dated Sep. 16, 2020 in U.S. Appl. No. 16/598,768.
- USPTO; Non-Final Office Action dated Oct. 16, 2020 in U.S. Appl. No. 16/679,885.
- USPTO; Non-Final Office Action dated Nov. 16, 2020 in U.S. Appl. No. 16/713,311.
- USPTO; Final Office Action dated Oct. 2, 2020 in U.S. Appl. No. 16/833,279.
- USPTO; Non-Final Office Action dated Jul. 9, 2020 in U.S. Appl. No. 16/897,158.
- USPTO; Notice of Allowance dated Nov. 12, 2020 in U.S. Appl. No. 16/897,158.
- USPTO; Non-Final Office Action dated Aug. 4, 2020 in U.S. Appl. No. 16/926,192.
- USPTO; Final Office Action dated Sep. 9, 2020 in U.S. Appl. No. 29/726,623.
- WIPO; International Search Report dated Oct. 13, 1998 in Application No. PCT/FI1998/000571.
- WIPO; International Search Report dated Jul. 13, 1990 in Application No. PCT/NL1990/000027.
- WIPO; International Search Report dated Jan. 11, 1990 in Application No. PCT/NL1990/000042.
- WIPO; International Search Report dated Feb. 26, 1991 in Application No. PCT/NL1990/000166.
- WIPO; International Search Report dated Oct. 25, 1991 in Application No. PCT/NL1991/000108.
- WIPO; International Search Report dated Oct. 17, 1997 in Application No. PCT/NL1997/000398.
- WIPO; International Preliminary Examination Report dated Oct. 2, 1998 in Application No. PCT/NL1997/000398.
- WIPO; International Search Report dated Apr. 24, 1998 in Application No. PCT/NL1998/000055.
- WIPO; International Preliminary Examination Report dated Feb. 24, 1999 in Application No. PCT/NL1998/000055.
- WIPO; International Search Report dated May 27, 1998 in Application No. PCT/NL1998/000105.
- WIPO; International Search Report dated May 8, 1998 in Application No. PCT/NL1998/000151.
- WIPO; International Preliminary Examination Report dated Mar. 23, 1999 in Application No. PCT/NL1998/000151.
- WIPO; International Search Report dated May 27, 1998 in Application No. PCT/NL1998/000167.
- WIPO; International Preliminary Examination Report dated Jul. 13, 1999 in Application No. PCT/NL1998/000167.
- WIPO; International Search Report dated Jul. 8, 1998 in Application No. PCT/NL1998/000204.
- WIPO; International Search Report dated Aug. 21, 1998 in Application No. PCT/NL1998/000246.
- WIPO; International Search Report dated Oct. 16, 1998 in Application No. PCT/NL1998/000383.
- WIPO; International Preliminary Examination Report dated Sep. 16, 1999 in Application No. PCT/NL1998/000383.
- WIPO; International Search Report dated Apr. 15, 1999 in Application No. PCT/NL1999/000047.
- WIPO; International Search Report dated Oct. 12, 1999 in Application No. PCT/NL1999/000487.
- WIPO; International Search Report dated Dec. 16, 1999 in Application No. PCT/NL1999/000583.
- WIPO; Written Opinion dated Jul. 24, 2000 in Application No. PCT/NL1999/000583.
- WIPO; International Preliminary Examination Report dated Jan. 22, 2001 in Application No. PCT/NL1999/000583.
- WIPO; International Search Report dated Apr. 19, 2000 in Application No. PCT/NL2000/000020.
- WIPO; Written Opinion dated Oct. 17, 2000 in Application No. PCT/NL2000/000020.
- WIPO; International Search Report dated Dec. 16, 1999 in Application No. PCT/RU1999/000328.
- WIPO; International Preliminary Examination Report dated Jun. 29, 2001 in Application No. PCT/RU1999/000328.
- Akiyama et al. "Macro- and micro-scale simulation of growth rate and composition in MOCVD of yttria-stabilized zirconia" *J. Crystal Growth* 241, pp. 352-362 (2002).
- Altieri et al. "Review Article: Plasma-surface interactions at the atomic scale for patterning metals" *J. Vac. Sci. Technol. A* 35, 05C203, 13 pages (2017).
- Ande et al. "Role of Surface Termination in Atomic Layer Deposition of Silicon Nitride" *J. Phys. Chem. Lett.* 6(18), 16 pages (2015).
- Atta et al. "The Catalytic Activity of Ruthenates ARuO₃ (A=Ca, Sr or Ba) for the Hydrogen Evolution Reaction in Acidic Medium" *Int. J. Electrochem. Sci.* 7, pp. 725-746 (2012).
- Ballal "Mass Transfer in Porous Solids under Pulsating Pressure Conditions" *SLJ International*, vol. 35, Nov. 4, pp. 446-448 (1995).
- Brewin et al. "UPS to deploy Bluetooth, wireless LAN network" *Internet*, pp. 1-5 (2001).
- Bulletin Plasma Source—12/02: Type AX7610—Downstream Plasma Source. Source location: MKS Instruments, Inc. <http://www.mksinst.com/>. Accessed: Aug. 6, 2015. pp. 1-4 (2002).
- Bulletin ASTRONe—4/02: Type AX7680—Reactive Gas Generator. Source location: MKS Instruments, Inc. <http://www.mksinst.com/>. Accessed: Aug. 6, 2015. pp. 1-2 (2002).
- Bulletin ASTRONex—7/09: Type AX7685—Reactive Gas Generator. Source location: MKS Instruments, Inc. <http://www.mksinst.com/>. Accessed: Aug. 6, 2015. pp. 1-2 (2002).

(56)

References Cited

OTHER PUBLICATIONS

- Bulletin ASTRON hf-s—3/05: Type AX7645—Reactive Gas Generator. Source location: MKS Instruments, Inc. <http://www.mksinst.com/>. Accessed: Aug. 6, 2015. pp. 1-2 (2005).
- Bulletin ENG-XSTREAM-340-09 OM 8/06: Xstream with Active Matching Network Remote Plasma Source. Advanced Energy Industries, Inc. <http://www.advanced-energy.net.cn/upload/File/Sources/ENG-Xstream-340-09.pdf>. Accessed: Jul. 19, 2016. pp. 1-4 (2006).
- Bulletin R*evolution—9/06: Type AX7690—Remote Plasma Source. Source location: MKS Instruments, Inc. <http://www.mksinst.com/>. Accessed: Aug. 6, 2015. pp. 1-2 (2006).
- Callaghan et al. “Magnetic Interactions in Ternary Ruthenium Oxides” *Inorganic Chemistry*, vol. 5, No. 9, pp. 1572-1576 (1966).
- Choi et al. “UV irradiation effects on the bonding structure and electrical properties of ultra low-k SiOC(-H) thin films for 45 nm technology node” *Current Applied Physics*, 11, S109-S113 (2011).
- Crystal IS “Application Note: Using UV Reflective Materials to Maximize Disinfection”; AN011; Jun. 16, 2016, found at <https://www.klaran.com/using-uv-reflective-materials-to-maximize-disinfection>.
- Dufond et al. “Quantifying the Extent of Ligand Incorporation and the Effect on Properties of TiO₂ Thin Films Grown by Atomic Layer Deposition Using an Alkoxide or an Alkylamide” *Chemistry of Material*, American Chemical Society 32(4), pp. 1393-1407 (2020).
- Dultsev et al. “Effect of UV radiation on the reactivity of porous methyl-doped SiO₂ layers” *Phys. Status Solidi C*, 8, No. 6, pp. 1946-1949 (2011).
- Esposito et al. “Preparation and characterization of lead ruthenate based composite cathodes for SOFC applications” *Mater. Res. Soc. Symp. Proc.*, vol. 835, 6 pages (2005).
- Fray et al. “Aspects of the Application of Electrochemistry to the Extraction of Titanium and Its Applications” *Materials Transactions*, vol. 58, No. 3, pp. 306-312 (2017).
- Freund et al. “Single crystal growth from separated educts and its application to lithium transition-metal oxides” *Sci. Rep.* 6, 35362, pp. 1-5 (2016).
- Frequently Asked Question, “What is a load lock chamber?”, Kurt J. Lesker Company, www.lesker.com, p. 1 (2020).
- Hong et al. “Ultralow-dielectric-constant amorphous boron nitride” *Nature*, vol. 582, 16 pages (2020).
- Ivanova et al. “ALD of Sc₂O₃ using Sc(Cp)₃ and a Novel Heteroleptic Precursors” Presented on the AVS 19th International Conference on Atomic Layer Deposition, Jul. 23, 2019, Abstract, 1 page (2019).
- Johnson et al. “A brief review of atomic layer deposition: from fundamentals to applications” *Materials Today*, vol. 17, Issue 5, pp. 236-246 (2014).
- Juppo et al. “Deposition of molybdenum thin films by an alternate supply of MoCl₅ and Zn” *J of Vacuum Science & Technology A*, 16, pp. 2845-2850 (1998).
- Kim et al. “Thermal Decomposition of Tetrakis(ethylmethylamido) Titanium for Chemical Vapor Deposition of Titanium Nitride” *Bull. Korean Chem. Soc.*, vol. 27, No. 2, 5 pages (2006).
- Kirsch et al. “Dipole model explaining high-k/metal gate field effect transistor threshold voltage tuning” *Applied Physics Letters* 92, 092901, 3 pages (2008).
- Kjesbu, ABB Corporate Research, Internet, pp. 1-37 (2002).
- Kofuji et al. “Line-edge roughness increase due to wiggling enhanced by initial pattern waviness” *Jpn. J. Appl. Phys.* 53, 03DE01, pp. 1-7 (2014).
- Kofuji et al. “Mechanism of wiggling enhancement due to HBr gas addition during amorphous carbon etching” *Jpn. J. Appl. Phys.* 54, 06FH04, pp. 107 (2015).
- Kovalgin et al. “Hot-Wire Assisted ALD: A Study Powered by In Situ Spectroscopic Ellipsometry” *Adv. Mater. Interfaces* 4, 1700058, 11 pages (2017).
- Krumdieck et al. “Experimental Characterization and Modeling of Pulsed MOCVD with Ultrasonic Atomization of Liquid Precursor” *Chem. Vap. Deposition*, 7 (2), pp. 85-90 (2001).
- Krumdieck “Kinetic Model of Low Pressure Film Deposition from Single Precursor Vapor in a Well-Mixed, Cold-Wall Reactor” *Acta mater.*, 49, pp. 583-588 (2001).
- Kuchumov et al. “Pulsed MO CVD Processes of MgO Layer Deposition from Mg(thd)₂” *ECS Trans.* 25, pp. 927-934 (2009).
- Kukli et al. “Atomic Layer Deposition and Chemical Vapor Deposition of Tantalum Oxide by Successive and Simultaneous Pulsing of Tantalum Ethoxide and Tantalum Chloride” *Chem. Mater.* 12, pp. 1914-1920 (2000).
- Kukli et al. “Atomic Layer Epitaxy Growth of Tantalum Oxide Thin Films from Ta(OC₂H₅)₅ and H₂O” *The Electrochemical Society*, vol. 142, No. 5, pp. 1670-1674 (1995).
- Kumar et al. “Bringing the benefits of Java to Bluetooth” <http://www.allembedded.com/story/OEG20020519S001>, pp. 1-3 (2002).
- Mameli et al. “Area-Selective Atomic Layer Deposition of SiO₂ Using Acetylacetone as a Chemoselective Inhibitor in an ABC-Type Cycle” *ACS Nano* 11, pp. 9303-9311 (2017).
- Mameli et al. “Isotropic Atomic Layer Etching of ZnO Using Acetylacetone and O₂ Plasma” *ACS Appl. Mater. Interfaces* 10, pp. 38588-38595 (2018).
- Naslain et al. “Synthesis of highly tailored ceramic matrix composites by pressure-pulsed CVD” *Solid State Ionics*, 141-142, pp. 541-548 (2001).
- Niinisto et al. “Advanced electronic and optoelectronic materials by Atomic Layer Deposition: An overview with special emphasis on recent progress in processing of high-k dielectrics and other oxide materials” *Pus. Stat. Sol. (a)* 201, No. 7, pp. 1443-1452 (2004).
- Ohzawa et al. “Preparation of fibrous SiC shape using pressure-pulsed chemical vapour infiltration and its properties as a high-temperature filter” *J. of Materials Processing Technology*, 96, pp. 151-156 (1999).
- O’Malley et al. “Structure and properties of ordered Li₂IrO₃ and Li₂PtO₃” *Journal of Solid State Chemistry* 181, pp. 1803-1809 (2008).
- Park et al. “Atomic layer deposition of Y₂O₃ films using hetroleptic liquid (iPrCp)2Y(iPr-amd) precursor” *J. Mater. Chem. C*, 2, 9 pages (2014).
- Posseme et al. “Alternative process for thin layer etching: Application to nitride spacer etching stopping on silicon germanium” *Apply. Phys. Lett.* 105, 051604, pp. 1-4 (2014).
- Provine et al. “Atomic Layer Deposition: Introduction to the Theory and Cambridge Nanotech Savannah & Fiji” NNIN ALD Roadshow Presentation, 49 pages (2012).
- Rosemount 1199 Diaphragm Seal Systems, Product Data Sheet, 92 pages (2008).
- Senateur et al. “Pulsed Injection MOCVD of Functional Electronic Oxides” *Adv. Mater. Opt. Electron*, 10, pp. 155-161 (2000).
- Shevtsov et al. “An Apparatus for Pulse Chemical Vapor Deposition of Layers” *Instruments and Experimental Techniques*, vol. 56, No. 3, pp. 353-357 (2013).
- Shevtsov et al. “Effect of Spatial Image Transfer in a Pulse MOCVD Process” *Physics Procedia* 46, pp. 27-32 (2013).
- Stannowski et al. “Growth process and properties of silicon nitride deposited by hot-wire chemical vapor deposition” *J Applied Physics*, vol. 93 No. 5, 9 pages (2013).
- Tomozoi et al. “Effects of UV photon irradiation on SiO_x (0<x<2) structural properties” *Applied Surface Science* 253, pp. 376-380 (2006).
- U.S. Appl. No. 60/394,086, filed Jul. 3, 2002 in the name of Jacques Schmitt, and entitled “ALD on a Rotary Susceptor” pp. 1-23 (2002).
- U.S. Appl. No. 62/293,897, filed Feb. 11, 2016 in the names of Bernardo Donoso et al., and entitled “Vapor Based Site-Isolated Processing Systems and Methods” pp. 1-51 (2016).
- Vallat et al. “Area selective deposition of TiO₂ by intercalation of plasma etching cycles in PEALD process: A bottom up approach for the simplification of 3D integration scheme” *Journal of Vacuum Science & Technology A* 37(2), 12 pages (2019).
- Vallat et al. “Selective deposition of Ta₂O₅ by adding plasma etching super-cycles in plasma enhanced atomic layer deposition steps” *Journal of Vacuum Science & Technology A* 35(1), 7 pages (2016).

(56)

References Cited

OTHER PUBLICATIONS

Venkatesan et al. "A rugged lead-ruthenate pyrochlore membrane catalyst for highly selective oxidation of alcohols" *J. Molecular Catalysis A: Chemical* 250, pp. 87-93 (2006).

Xiao "Introduction to Semiconductor Manufacturing Technology" SPIE Press, ISBN 978-0-08194-9092-6, pp. 237-245 (2012).

Yuan et al. "A Bifunctional Air Electrode Catalyzed by Lead Ruthenate for Li-Air Batteries" *ECS Transactions* 69(19), pp. 23-32 (2015).

Zhao et al. "Surface Chemistry of Thermal Dry Etching of Cobalt Thin Films Using Hexafluoroacetylacetone (hfacH)" *Appl Surf Sci.* 455, pp. 438-445 (2018).

Zhao et al. "Thermal and Plasma-Enhanced Atomic Layer Deposition of Yttrium Oxide Films and the Properties of Water Wettability" *Appl. Mater. Interfac.* 12(2), 9 pages (2019).

CNIPA; Notice of Allowance dated Sep. 3, 2019 in Application No. 201610141027.1.

CNIPA; Notice of Allowance dated Sep. 30, 2010 in Application No. 201510765170.3.

CNIPA; Office Action dated Jul. 23, 2019 in Application No. 201610897958.4.

EPO; Notice of Allowance dated Aug. 1, 2019 in Application No. 09767208.3.

JPO; Office Action dated Aug. 29, 2019 in Application No. 2016001928.

KIPO; Notice of Allowance dated Jul. 5, 2019 in Application No. 10-2012-0064526.

KIPO; Notice of Allowance dated Aug. 29, 2019 in Application No. 10-2013-0036823.

KIPO; Office Action dated Aug. 27, 2019 in Application No. 10-2013-0049598.

KIPO; Office Action dated Aug. 27, 2019 in Application No. 10-2013-0089998.

KIPO; Notice of Allowance dated Oct. 8, 2019 in Application No. 10-2013-0101944.

KIPO; Office Action dated Aug. 15, 2019 in Application No. 10-2013-0109390.

KIPO; Office Action dated Oct. 7, 2019 in Application No. 10-2013-0114079.

KIPO; Notice of Allowance dated Aug. 26, 2019 in Application No. 10-2014-7017110.

KIPO; Final Office Action dated Jun. 17, 2019 in Application No. 10-2017-7023740.

TIPO; Office Action dated Aug. 16, 2019 in Application No. 102136496.

TIPO; Notice of Allowance dated Jul. 10, 2019 in Application No. 103123439.

TIPO; Notice of Allowance dated Sep. 27, 2019 in Application No. 104105533.

TIPO; Notice of Allowance dated Sep. 23, 2019 in Application No. 104105965.

TIPO; Notice of Allowance dated Oct. 4, 2019 in Application No. 104122889.

TIPO; Notice of Allowance dated Jul. 19, 2019 in Application No. 104122890.

TIPO; Office Action dated Jul. 5, 2019 in Application No. 105112363.

TIPO; Office Action dated Sep. 9, 2019 in Application No. 105115513.

TIPO; Notice of Allowance dated Sep. 20, 2019 in Application No. 106138800.

TIPO; Office Action dated Aug. 27, 2019 in Application No. 107116804.

TIPO; Office Action dated Jun. 28, 2019 in Application No. 108102948.

USPTO; Non-Final Office Action dated Aug. 19, 2019 in U.S. Appl. No. 13/184,351.

USPTO; Advisory Action dated Feb. 12, 2016 in U.S. Appl. No. 13/651,144.

USPTO; Advisory Action dated Dec. 29, 2016 in U.S. Appl. No. 13/651,144.

USPTO; Non-Final Office Action dated Sep. 18, 2019 in U.S. Appl. No. 13/651,144.

USPTO; Advisory Action dated Jun. 26, 2015 in U.S. Appl. No. 13/791,246.

USPTO; Notice of Allowance dated Apr. 22, 2016 in U.S. Appl. No. 14/172,220.

USPTO; Non-Final Office Action dated Aug. 8, 2019 in U.S. Appl. No. 14/188,760.

USPTO; Notice of Allowance dated Aug. 19, 2016 in U.S. Appl. No. 14/268,348.

USPTO; Non-Final Office Action dated Aug. 8, 2019 in U.S. Appl. No. 14/444,744.

USPTO; Advisory Action dated Nov. 6, 2015 in U.S. Appl. No. 14/457,058.

USPTO; Notice of Allowance dated Aug. 16, 2017 in U.S. Appl. No. 14/606,364.

USPTO; Notice of Allowance dated Aug. 15, 2019 in U.S. Appl. No. 14/645,234.

USPTO; Non-Final Office Action dated Sep. 19, 2019 in U.S. Appl. No. 14/829,565.

USPTO; Final Office Action dated Jun. 10, 2016 in U.S. Appl. No. 14/987,420.

USPTO; Notice of Allowance dated Mar. 26, 2018 in U.S. Appl. No. 15/144,481.

USPTO; Final Office Action dated Aug. 9, 2019 in U.S. Appl. No. 15/205,827.

USPTO; Non-Final Office Action dated Aug. 5, 2019 in U.S. Appl. No. 15/262,990.

USPTO; Advisory Action dated Jul. 29, 2019 in U.S. Appl. No. 15/402,993.

USPTO; Notice of Allowance dated Aug. 14, 2019 in U.S. Appl. No. 15/410,503.

USPTO; Final Office Action dated Aug. 20, 2019 in U.S. Appl. No. 14/508,489.

USPTO; Notice of Allowance dated Aug. 21, 2019 in U.S. Appl. No. 15/592,730.

USPTO; Notice of Allowance dated Sep. 11, 2019 in U.S. Appl. No. 15/598,169.

USPTO; Non-Final Office Action dated Sep. 4, 2019 in U.S. Appl. No. 15/615,489.

USPTO; Non-Final Office Action dated Jul. 29, 2019 in U.S. Appl. No. 15/660,797.

USPTO; Notice of Allowance dated Aug. 22, 2019 in U.S. Appl. No. 15/660,805.

USPTO; Final Office Action dated Jul. 26, 2019 in U.S. Appl. No. 15/690,017.

USPTO; Final Office Action dated Aug. 12, 2019 in U.S. Appl. No. 15/707,786.

USPTO; Non-Final Office Action dated Jul. 8, 2019 in U.S. Appl. No. 15/726,959.

USPTO; Final Office Action dated Jul. 31, 2019 in U.S. Appl. No. 15/795,056.

USPTO; Non-Final Office Action dated Oct. 2, 2019 in U.S. Appl. No. 15/798,201.

USPTO; Non-Final Office Action dated Aug. 20, 2019 in U.S. Appl. No. 15/815,483.

USPTO; Notice of Allowance dated Aug. 16, 2019 in U.S. Appl. No. 15/836,547.

USPTO; Non-Final Office Action dated Jul. 31, 2019 in U.S. Appl. No. 15/860,564.

USPTO; Final Office Action dated Aug. 21, 2019 in U.S. Appl. No. 15/879,209.

USPTO; Notice of Allowance dated Sep. 23, 2019 in U.S. Appl. No. 15/886,225.

USPTO; Non-Final Office Action dated Sep. 19, 2019 in U.S. Appl. No. 15/897,578.

USPTO; Final Office Action dated Aug. 28, 2019 in U.S. Appl. No. 15/917,224.

USPTO; Notice of Allowance dated Aug. 30, 2019 in U.S. Appl. No. 15/917,262.

USPTO; Non-Final Office Action dated Jul. 22, 2019 in U.S. Appl. No. 15/940,759.

USPTO; Notice of Allowance dated Aug. 26, 2019 in U.S. Appl. No. 15/940,801.

(56)

References Cited

OTHER PUBLICATIONS

- USPTO; Notice of Allowance dated Aug. 22, 2019 in U.S. Appl. No. 15/985,298.
- USPTO; Notice of Allowance dated Jul. 31, 2019 in U.S. Appl. No. 15/987,755.
- USPTO; Non-Final Office Action dated Jul. 29, 2019 in U.S. Appl. No. 16/000,125.
- USPTO; Final Office Action dated Aug. 23, 2019 in U.S. Appl. No. 16/018,692.
- USPTO; Non-Final Office Action dated Aug. 7, 2019 in U.S. Appl. No. 16/024,390.
- USPTO; Notice of Allowance dated Jul. 10, 2019 in U.S. Appl. No. 16/046,218.
- USPTO; Final Office Action dated Sep. 25, 2019 in U.S. Appl. No. 16/147,047.
- USPTO; Non-Final Office Action dated Aug. 6, 2019 in U.S. Appl. No. 16/158,077.
- USPTO; Final Office Action dated Sep. 26, 2019 in U.S. Appl. No. 16/188,690.
- USPTO; Non-Final Office Action dated Aug. 29, 2019 in U.S. Appl. No. 16/161,744.
- USPTO; Non-Final Office Action dated Aug. 16, 2019 in U.S. Appl. No. 16/167,225.
- USPTO; Non-Final Office Action dated Aug. 19, 2019 in U.S. Appl. No. 16/208,062.
- USPTO; Non-Final Office Action dated Sep. 16, 2019 in U.S. Appl. No. 16/213,702.
- USPTO; Non-Final Office Action dated Aug. 21, 2019 in U.S. Appl. No. 29/634,768.
- WIPO; International Search Report and Written Opinion dated Jun. 28, 2019 in Application No. PCT/IB2019/000084.
- Bark et al. "Large-area niobium disulfide thin films as transparent electrodes for devices based on two-dimensional materials," *Nanoscale*, published online, 7 pages (2012).
- Barreca et al. "Cobalt oxide nanomaterials by vapor phase synthesis for fast and reversible lithium storage" *J Phys Chem C*, 114, 10054-10060 (2010).
- Basuvalingam et al. "NS-WeA6—Low Temperature ALD for Phase-controlled Synthesis of 2D Transition Metal (M=Ti, Nb) di-(MX₂) and Tri-(MX₃) Sulfides," AVS 19th International Conference on Atomic Layer Deposition (ALD 2019), Jul. 22, 2019, Abstract, 1 page (2019).
- Cahiez et al. "Cobalt-Catalyzed cross coupling reaction between functionalized primary and secondary alkyl halides and aliphatic grignard reagents" *Adv. Synth. Catal.* 350, 1484-1488 (2008).
- "Fiji F200 200mm Thermal/Plasma ALD Systems: Installation and Use Manual." CAW-02635 Rev. 0.6 (Mar. 13, 2012). Cambridge NanoTech Inc. pp. 1-164 (2012).
- Ge et al. "Large-scale synthesis of NbS₂ nanosheets with controlled orientation on graphene by ambient pressure CVD," *Nanoscale*, vol. 5, 5773-5778 (2013).
- Gordon et al. "A Kinetic Model for Step Coverage by Atomic Layer Deposition in Narrow Holes or Trenches." *Chemical Vapor Deposition*. 9 [2]. pp. 73-78 (2003).
- Hansen. "A Primer on Vacuum Pressure Measurement." *Vacuum Technology & Coating*. Jun. 2009. pp. 36-42 (2009).
- Hansen. "Speed, Pressure and Throughput: Part 1 System Diagnostics." *Vacuum Technology & Coating*. Sep. 2011. pp. 14-17 (2011).
- Hansen. "Speed, Pressure and Throughput: Part 2 Managing Gas Flow in High Vacuum Systems." *Vacuum Technology & Coating*. Oct. 2011. pp. 19-22 (2011).
- Hansen. "Speed, Pressure and Throughput: Part 3 Automating the Pressure Control Process." *Vacuum Technology & Coating*. Nov. 2011. pp. 22-25 (2011).
- Hansen. "Speed, Pressure and Throughput: Part 4 Outgassing and Base Pressure." *Vacuum Technology & Coating*. Dec. 2011. pp. 22-25 (2011).
- Hansen. "Speed, Pressure and Throughput: Part 5 Leaks and Gas Flow in Leak Detection." *Vacuum Technology & Coating*. Jan. 2012. pp. 18-21 (2011).
- Khandelwal et al. "Low-temperature Ar/N₂ remote plasma nitridation of SiO₂ thin films," *J. Vacuum Science & Technology A*, 20(6), pp. 1989-1996 (2002).
- Kucheyev et al. "Mechanisms of Atomic Layer Deposition on Substrates with Ultrahigh Aspect Ratios." *Langmuir*. 24 [3], pp. 943-948 (2008).
- Londergan et al. "Engineered Low Resistivity Titanium-Tantalum Nitride Films by Atomic Layer Deposition," *Mat. Res. Soc. Symp. Proc.*, vol. 714E, pp. L5.3.1-L5.3.6 (2001).
- Naito et al. "Electrical Transport Properties in 2H—NbS₂, —NbSe₂, —TaS₂ and —TaSe₂," *J. of Physical Society of Japan*, vol. 51, No. 1, 219-227 (1982).
- Pichler. "Intrinsic Point Defects, Impurities and Their Diffusion in Silicon," Springer-Verlag Wien, p. 367 (2004).
- Tidman et al. "Resistivity of thin TaS₂ crystals," *Can. J. Phys.*, vol. 54, 2306-2309 (1976).
- Trumbore et al. "Solid solubilities of aluminum and gallium in germanium," *J. of Physics and Chemistry of Solids*, vol. 11, Issues 3-4, 239-240 (1959).
- CNIPA; Office Action dated Mar. 30, 2021 in Application No. 201610131743.1.
- CNIPA; Office Action dated Mar. 1, 2021 in Application No. 201710131319.1.
- CNIPA; Notice of Allowance dated Mar. 30, 2021 in Application No. 201710762817.6.
- CNIPA; Office Action dated Jan. 28, 2021 in Application No. 201711057557.9.
- CNIPA; Office Action dated Jan. 26, 2021 in Application No. 201711057929.8.
- CNIPA; Office Action dated Apr. 19, 2021 in Application No. 201711328250.8.
- CNIPA; Notice of Allowance dated Apr. 7, 2021 in Application No. 201780044761.9.
- CNIPA; Office Action dated Jan. 29, 2021 in Application No. 201780076230.8.
- CNIPA; Office Action dated Jan. 27, 2021 in Application No. 201780076321.1.
- CNIPA; Office Action dated Mar. 24, 2021 in Application No. 201880048547.5.
- CNIPA; Office Action dated Dec. 22, 2020 in Application No. 201910378791.4.
- CNIPA; Notice of Allowance dated Apr. 7, 2021 in Application No. 202030579755.8.
- EPO; Extended European Search Report dated Apr. 6, 2021 in Application No. 21150514.4.
- JPO; Notice of Allowance dated Apr. 6, 2021 in Application No. 2017-139817.
- JPO; Office Action dated Mar. 31, 2021 in Application No. 2018-024655.
- JPO; Notice of Allowance dated Mar. 17, 2021 in Application No. 2020-010953.
- KIPO; Office Action dated Mar. 23, 2021 in Application No. 10-2014-0011765.
- KIPO; Office Action dated Apr. 27, 2021 in Application No. 10-2014-0027217.
- KIPO; Notice of Allowance dated Apr. 15, 2021 in Application No. 10-2014-0103853.
- KIPO; Notice of Allowance dated Mar. 25, 2021 in Application No. 10-2014-0128626.
- KIPO; Office Action dated Apr. 20, 2021 in Application No. 10-2014-0136089.
- KIPO; Office Action dated Mar. 19, 2021 in Application No. 10-2014-0156196.
- KIPO; Office Action dated Mar. 29, 2021 in Application No. 10-2014-0165685.
- KIPO; Office Action dated Apr. 5, 2021 in Application No. 10-2015-0031720.
- KIPO; Office Action dated Apr. 19, 2021 in Application No. 10-2015-0035094.
- KIPO; Office Action dated Mar. 8, 2021 in Application No. 10-2017-0054647.
- KIPO; Office Action dated Mar. 10, 2021 in Application No. 10-2017-0055703.

(56)

References Cited

OTHER PUBLICATIONS

- KIPO; Notice of Allowance dated May 24, 2021 in Application No. 10-2020-0101096.
- KIPO; Notice of Allowance dated Apr. 1, 2021 in Application No. 30-2020-0030139 (M001).
- KIPO; Notice of Allowance dated Apr. 1, 2021 in Application No. 30-2020-0030139 (M002).
- TIPO; Notice of Allowance dated May 13, 2021 in Application No. 105122394.
- TIPO; Notice of Allowance dated Mar. 5, 2021 in Application No. 105131284.
- TIPO; Office Action dated Feb. 25, 2021 in Application No. 105134275.
- TIPO; Notice of Allowance dated Mar. 4, 2021 in Application No. 106100823.
- TIPO; Notice of Allowance dated May 6, 2021 in Application No. 106108522.
- TIPO; Notice of Allowance dated Mar. 4, 2021 in Application No. 106111693.
- TIPO; Office Action dated Feb. 25, 2021 in Application No. 106121797.
- TIPO; Office Action dated Apr. 26, 2021 in Application No. 106122231.
- TIPO; Office Action dated Apr. 22, 2021 in Application No. 106124126.
- TIPO; Office Action dated Apr. 22, 2021 in Application No. 106124128.
- TIPO; Notice of Allowance dated Mar. 25, 2021 in Application No. 106124130.
- TIPO; Office Action dated Mar. 4, 2021 in Application No. 106127948.
- TIPO; Office Action dated Mar. 15, 2021 in Application No. 106129971.
- TIPO; Office Action dated Apr. 7, 2021 in Application No. 106135925.
- TIPO; Office Action dated Apr. 7, 2021 in Application No. 106136905.
- TIPO; Office Action dated Mar. 29, 2021 in Application No. 106143559.
- TIPO; Office Action dated Mar. 31, 2021 in Application No. 106143570.
- TIPO; Office Action dated Jan. 15, 2021 in Application No. 108142842.
- TIPO; Office Action dated Jan. 25, 2021 in Application No. 108143562.
- TIPO; Notice of Allowance dated May 18, 2021 in Application No. 109300595.
- TIPO; Notice of Allowance dated Mar. 30, 2021 in Application No. 109305460.
- USPTO; Notice of Allowance dated Feb. 10, 2021 in U.S. Appl. No. 14/219,839.
- USPTO; Advisory Action dated Apr. 13, 2021 in U.S. Appl. No. 14/829,565.
- USPTO; Non-Final Office Action dated May 12, 2021 in U.S. Appl. No. 14/829,565.
- USPTO; Final Office Action dated Feb. 24, 2021 in U.S. Appl. No. 15/262,990.
- USPTO; Advisory Action dated Apr. 28, 2021 in U.S. Appl. No. 15/262,990.
- USPTO; Final Office Action dated Mar. 25, 2021 in U.S. Appl. No. 15/286,503.
- USPTO; Advisory Action dated Apr. 30, 2021 in U.S. Appl. No. 15/377,439.
- USPTO; Final Office Action dated Jan. 7, 2021 in U.S. Appl. No. 15/380,909.
- USPTO; Non-Final Office Action dated Feb. 9, 2021 in U.S. Appl. No. 15/402,993.
- USPTO; Final Office Action dated May 21, 2021 in U.S. Appl. No. 15/402,993.
- USPTO; Final Office Action dated Jun. 2, 2021 in U.S. Appl. No. 15/611,707.
- USPTO; Advisory Action dated Mar. 25, 2021 in U.S. Appl. No. 15/636,307.
- USPTO; Non-Final Office Action dated Apr. 21, 2021 in U.S. Appl. No. 15/636,307.
- USPTO; Final Office Action dated Mar. 10, 2021 in U.S. Appl. No. 15/690,017.
- USPTO; Notice of Allowance dated Apr. 16, 2021 in U.S. Appl. No. 15/691,241.
- USPTO; Non-Final Office Action dated Mar. 18, 2021 in U.S. Appl. No. 15/835,328.
- USPTO; Notice of Allowance dated Mar. 19, 2021 in U.S. Appl. No. 15/890,037.
- USPTO; Final Office Action dated Apr. 19, 2021 in U.S. Appl. No. 15/909,705.
- USPTO; Non-Final Office Action dated May 20, 2021 in U.S. Appl. No. 15/917,224.
- USPTO; Non-Final Office Action dated Feb. 18, 2021 in U.S. Appl. No. 15/923,834.
- USPTO; Advisory Action dated Apr. 28, 2021 in U.S. Appl. No. 15/940,729.
- USPTO; Notice of Allowance dated Apr. 7, 2021 in U.S. Appl. No. 15/940,759.
- USPTO; Advisory Action dated Feb. 22, 2021 in U.S. Appl. No. 15/962,980.
- USPTO; Final Office Action dated Apr. 13, 2021 in U.S. Appl. No. 15/967,146.
- USPTO; Advisory Action dated Jun. 2, 2021 in U.S. Appl. No. 15/967,146.
- USPTO; Non-Final Office Action dated Feb. 19, 2021 in U.S. Appl. No. 15/974,948.
- USPTO; Non-Final Office Action dated May 25, 2021 in U.S. Appl. No. 15/985,539.
- USPTO; Non-Final Office Action dated Apr. 5, 2021 in U.S. Appl. No. 15/996,286.
- USPTO; Non-Final Office Action dated Feb. 4, 2021 in U.S. Appl. No. 16/000,109.
- USPTO; Non-Final Office Action dated May 19, 2021 in U.S. Appl. No. 16/000,125.
- USPTO; Notice of Allowance dated Feb. 5, 2021 in U.S. Appl. No. 16/000,156.
- USPTO; Non-Final Office Action dated Mar. 19, 2021 in U.S. Appl. No. 16/004,041.
- USPTO; Final Office Action dated Mar. 23, 2021 in U.S. Appl. No. 16/039,817.
- USPTO; Advisory Action dated May 28, 2021 in U.S. Appl. No. 16/039,817.
- USPTO; Final Office Action dated Mar. 8, 2021 in U.S. Appl. No. 16/042,791.
- USPTO; Advisory Action dated May 14, 2021 in U.S. Appl. No. 16/042,791.
- USPTO; Notice of Allowance dated Mar. 10, 2021 in U.S. Appl. No. 16/055,532.
- USPTO; Final Office Action dated Mar. 23, 2021 in U.S. Appl. No. 16/105,745.
- USPTO; Final Office Action dated Mar. 24, 2021 in U.S. Appl. No. 16/105,761.
- USPTO; Advisory Action dated May 20, 2021 in U.S. Appl. No. 16/105,761.
- USPTO; Final Office Action dated Mar. 18, 2021 in U.S. Appl. No. 16/105,802.
- USPTO; Advisory Action dated May 27, 2021 in U.S. Appl. No. 16/105,802.
- USPTO; Advisory Action dated Feb. 17, 2021 in U.S. Appl. No. 16/108,950.
- USPTO; Non-Final Office Action dated Apr. 13, 2021 in U.S. Appl. No. 16/108,950.
- USPTO; Notice of Allowance dated Mar. 23, 2021 in U.S. Appl. No. 16/116,708.
- USPTO; Advisory Action dated Mar. 10, 2021 in U.S. Appl. No. 16/117,530.
- USPTO; Non-Final Office Action dated Mar. 23, 2021 in U.S. Appl. No. 16/151,074.
- USPTO; Final Office Action dated May 6, 2021 in U.S. Appl. No. 16/152,260.
- USPTO; Notice of Allowance dated Feb. 24, 2021 in U.S. Appl. No. 16/167,164.

(56)

References Cited

OTHER PUBLICATIONS

- USPTO; Non-Final Office Action dated Feb. 19, 2021 in U.S. Appl. No. 16/172,535.
- USPTO; Final Office Action dated May 27, 2021 in U.S. Appl. No. 16/172,535.
- USPTO; Advisory Action dated Apr. 5, 2021 in U.S. Appl. No. 16/176,517.
- USPTO; Notice of Allowance dated May 13, 2021 in U.S. Appl. No. 16/176,517.
- USPTO; Notice of Allowance dated Feb. 19, 2021 in U.S. Appl. No. 16/183,258.
- USPTO; Notice of Allowance dated Feb. 10, 2021 in U.S. Appl. No. 16/205,899.
- USPTO; Non-Final Office Action dated Mar. 29, 2021 in U.S. Appl. No. 16/206,589.
- USPTO; Advisory Action dated Feb. 25, 2021 in U.S. Appl. No. 16/210,922.
- USPTO; Final Office Action dated Mar. 29, 2021 in U.S. Appl. No. 16/219,555.
- USPTO; Non-Final Office Action dated May 2, 2021 in U.S. Appl. No. 16/240,392.
- USPTO; Advisory Action dated Jan. 26, 2021 in U.S. Appl. No. 16/251,534.
- USPTO; Non-Final Office Action dated Feb. 23, 2021 in U.S. Appl. No. 16/251,534.
- USPTO; Non-Final Office Action dated Mar. 30, 2021 in U.S. Appl. No. 16/252,567.
- USPTO; Non-Final Office Action dated Mar. 4, 2021 in U.S. Appl. No. 16/252,569.
- USPTO; Non-Final Office Action dated Apr. 20, 2021 in U.S. Appl. No. 16/397,045.
- USPTO; Notice of Allowance dated Mar. 10, 2021 in U.S. Appl. No. 16/400,814.
- USPTO; Non-Final Office Action dated May 7, 2021 in U.S. Appl. No. 16/423,824.
- USPTO; Notice of Allowance dated Apr. 28, 2021 in U.S. Appl. No. 16/453,249.
- USPTO; Final Office Action dated May 20, 2021 in U.S. Appl. No. 16/468,258.
- USPTO; Notice of Allowance dated Apr. 26, 2021 in U.S. Appl. No. 16/517,122.
- USPTO; Final Office Action dated May 12, 2021 in U.S. Appl. No. 16/546,543.
- USPTO; Non-Final Office Action dated Feb. 1, 2021 in U.S. Appl. No. 16/563,473.
- USPTO; Non-Final Office Action dated May 10, 2021 in U.S. Appl. No. 16/601,593.
- USPTO; Non-Final Office Action dated Feb. 24, 2021 in U.S. Appl. No. 16/637,134.
- USPTO; Notice of Allowance dated Jun. 2, 2021 in U.S. Appl. No. 16/637,134.
- USPTO; Notice of Allowance dated Apr. 30, 2021 in U.S. Appl. No. 16/685,787.
- USPTO; Non-Final Office Action dated Apr. 5, 2021 in U.S. Appl. No. 16/704,835.
- USPTO; Final Office Action dated Feb. 22, 2021 in U.S. Appl. No. 16/713,311.
- USPTO; Notice of Allowance dated May 20, 2021 in U.S. Appl. No. 16/752,514.
- USPTO; Notice of Allowance dated May 24, 2021 in U.S. Appl. No. 16/765,125.
- USPTO; Non-Final Office Action dated Apr. 15, 2021 in U.S. Appl. No. 16/789,138.
- USPTO; Notice of Allowance dated May 12, 2021 in U.S. Appl. No. 16/800,114.
- USPTO; Non-Final Office Action dated Apr. 5, 2021 in U.S. Appl. No. 16/816,078.
- USPTO; Non-Final Office Action dated May 19, 2021 in U.S. Appl. No. 16/828,753.
- USPTO; Non-Final Office Action dated May 4, 2021 in U.S. Appl. No. 16/872,045.
- USPTO; Non-Final Office Action dated May 3, 2021 in U.S. Appl. No. 16/878,443.
- USPTO; Non-Final Office Action dated Dec. 31, 2020 in U.S. Appl. No. 16/924,595.
- USPTO; Non-Final Office Action dated May 25, 2021 in U.S. Appl. No. 16/935,280.
- USPTO; Non-Final Office Action dated Apr. 14, 2021 in U.S. Appl. No. 17/009,093.
- USPTO; Ex Parte Quayle Action dated Apr. 13, 2021 in U.S. Appl. No. 29/679,620.
- USPTO; Notice of Allowance dated May 19, 2021 in U.S. Appl. No. 29/702,881.
- Aubin et al. "Very low temperature (450° C.) selective epitaxial growth of heavily in situ boron-doped SiGe layers" *Semiconductor Science and Technology*, 30, 10 pages (2015).
- Barnscheidt et al. "Highly boron-doped germanium layers on Si(001) grown by carbon-mediated epitaxy" *Semiconductor Science and Technology*, 33, 9 pages (2018).
- Belyansky et al. "Low Temperature Borophosphosilicate Glass (BPSG) Process for High Aspect Ratio Gap Fill" www.electrochem.org/dl/ma/201/pdfs/0705.pdf, downloaded May 15, 2021, 1 page.
- Cheremisin et al. "UV-laser modification and selective ion-beam etching of amorphous vanadium pentoxide thin films" *Phys. Status Solidi A, Applications and materials science*, 206 (7), pp. 1484-1487 (2009).
- Dingemans et al. "Plasma-Assisted ALD for the Conformal Deposition of SiO₂: Process, Material and Electronic Properties" *J of the Electrochemical Society*, 159(3), H277-H285 (2012).
- G02-1152 "Atomic Layer Deposition of Al₂O₃ with Alcohol Oxidants for Impeding Substrate Oxidation" Abstract. Oct. 16, 2019 (2019).
- Imamura et al. "Cyclic C₄F₈ and O₂ plasma etching of TiO₂ for high-aspect-ratio three-dimensional devices" *Template for JJAP Regular Papers*, Jan. 2014, pp. 29 (2014).
- Kim et al. "A process for topographically selective deposition on 3D nanostructures by ion implantation" *ACS Nano*, 10, 4, 4451-4458 (2016).
- Lee et al. "Ultraviolet light enhancement of Ta₂O₅ dry etch rates" *J. of Vacuum Science & Technology B: Microelectronics and Nanometer Structures Processing, Measurement, and Phenomena*, 18, pp. 293-295 (2000).
- Musschoot et al. "Atomic layer deposition of titanium nitride from TDMAT precursor" *Microelectronic Engineering*, 86, pp. 72-77 (2009).
- Noircler et al. "Transmission electron microscopy characterization of low temperature boron doped silicon epitaxial films" *CrystEngComm*, 22(3 3), pp. 5464-5472 (2020).
- Oyama et al. "Topotactic synthesis of vanadium nitride solid foams" *Journal of Materials Research* vol. 8. No. 6, pp. 1450-1454 (1993).
- Rimoldi et al. "Atomic Layer Deposition of Rhenium-Aluminum Oxide Thin Films and ReOx Incorporation in a Metal-Organic Framework" *Applied Materials & Interfaces*, 9, pp. 35067-35074 (2017).
- Standard Motor Products LX249 Ignition Pick Up, Nov. 11, 2005, Amazon.com, May 10, 2021. URL: <https://www.amazon.com/Standard-Motor-Products-LX249-Ignition/dp/B000C7ZTS4/> (2005).
- Tao et al. "Improved performance of GeON as charge storage layer in flash memory by optimal annealing" *Microelectronics Reliability*, vol. 52, pp. 2597-2601 (2012).
- Wirths et al. "Low temperature RPCVD epitaxial growth of Si_{1-x}Ge_x using Si₂H₆ and Ge₂H₆" *Solid-State Electronics*, 88, pp. 2-9 (2013).
- Yanguas-Gil et al. "Modulation of the Growth Per Cycle in Atomic Layer Deposition Using Reversible Surface Functionalization" *Chemistry of Materials*, 25, pp. 4849-4860 (2013).

* cited by examiner

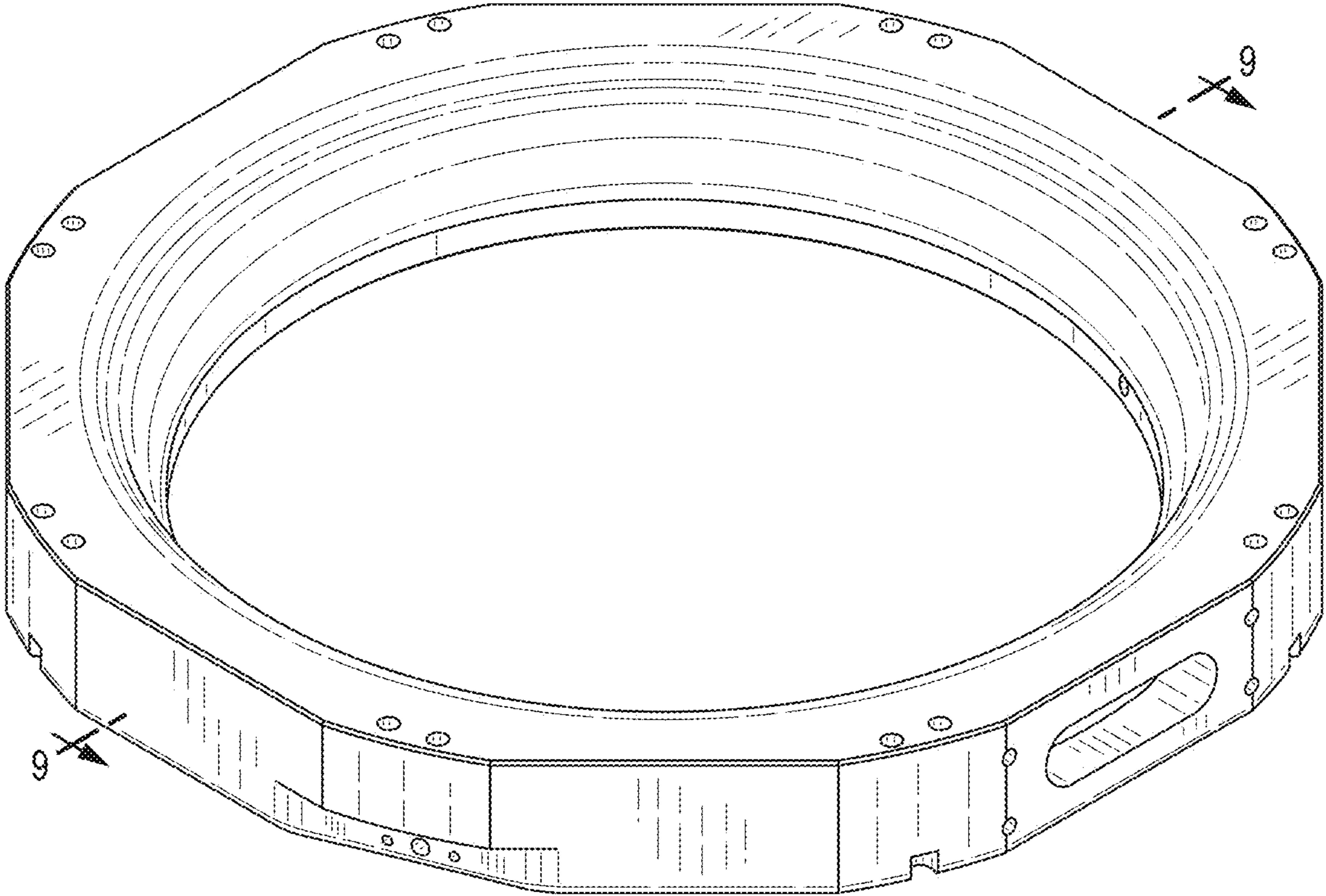

FIG.1

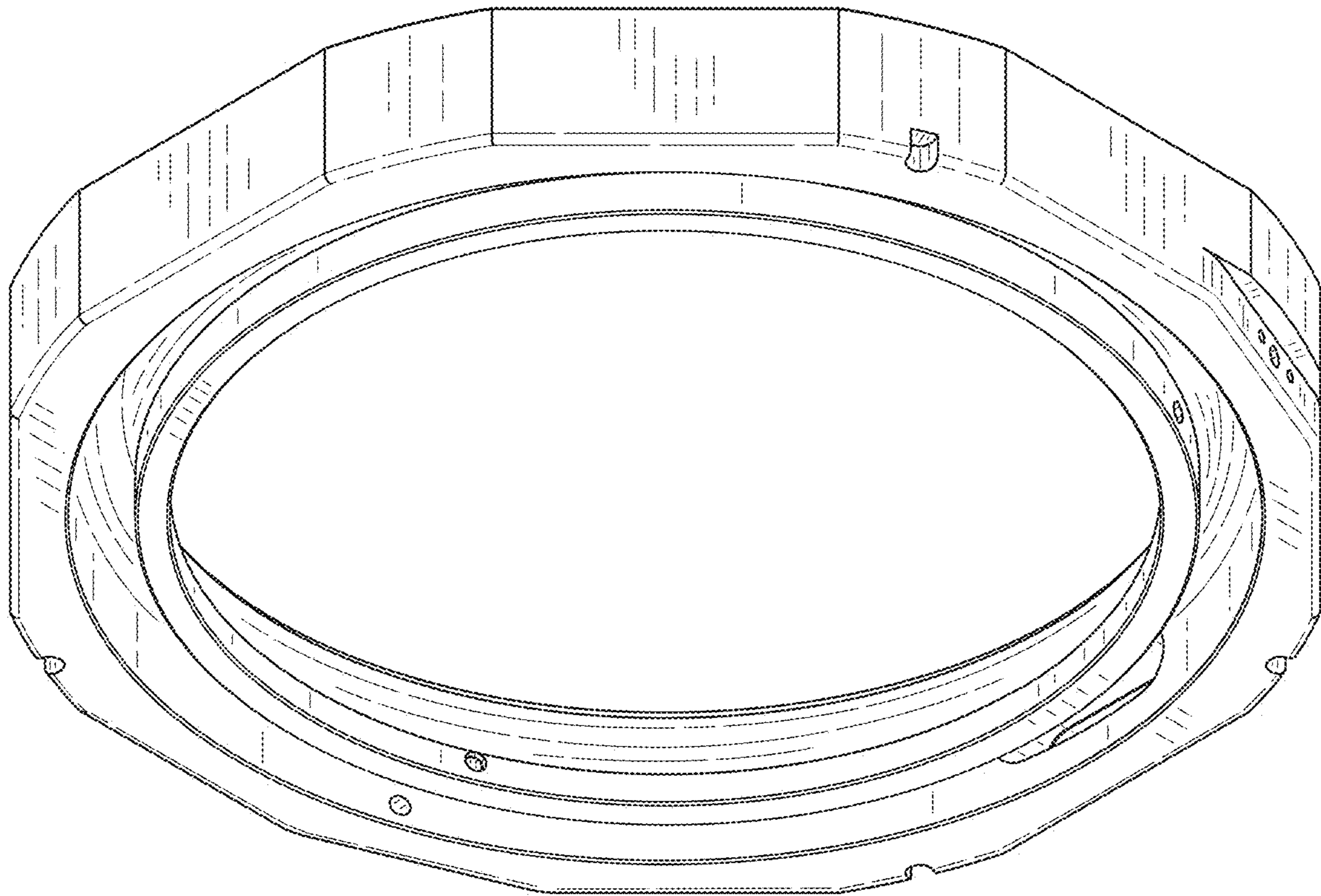

FIG.2

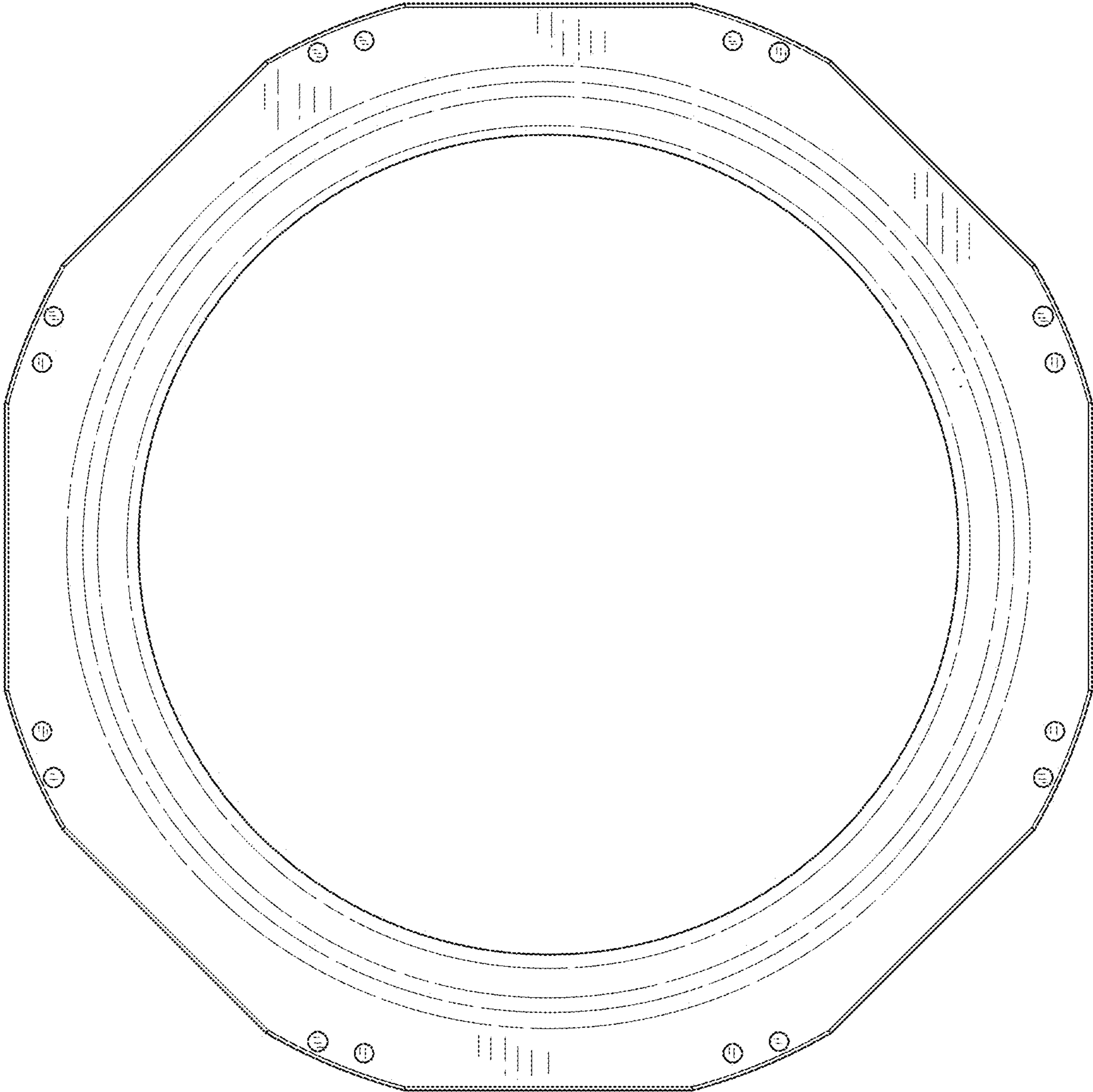

FIG.3

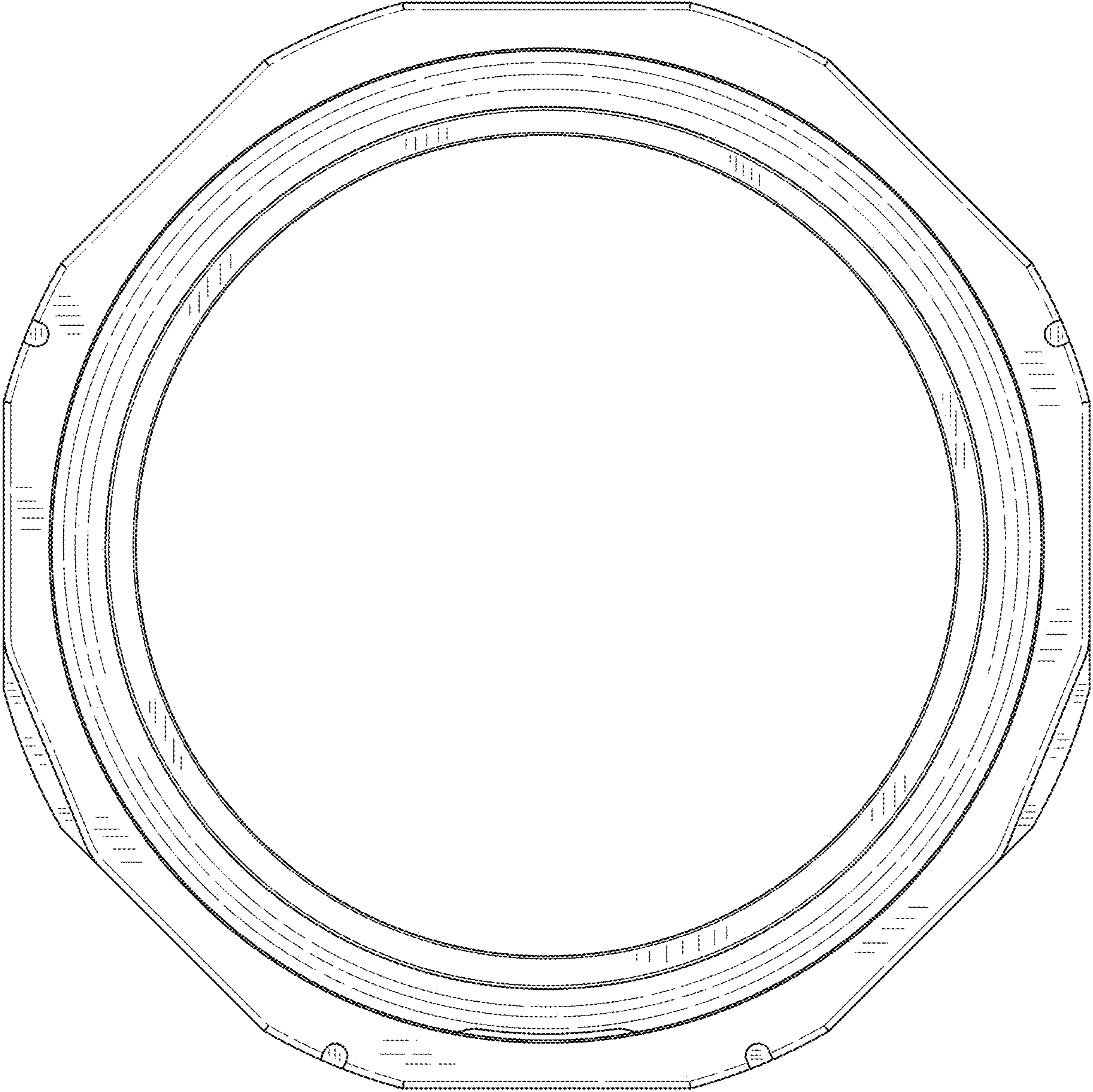

FIG.4

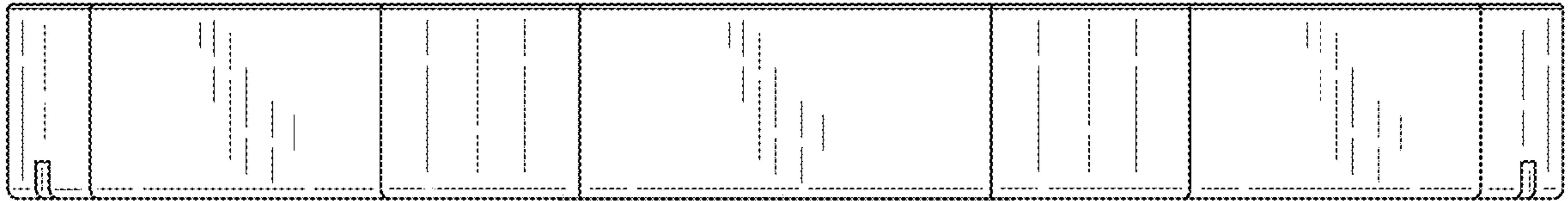

FIG. 5

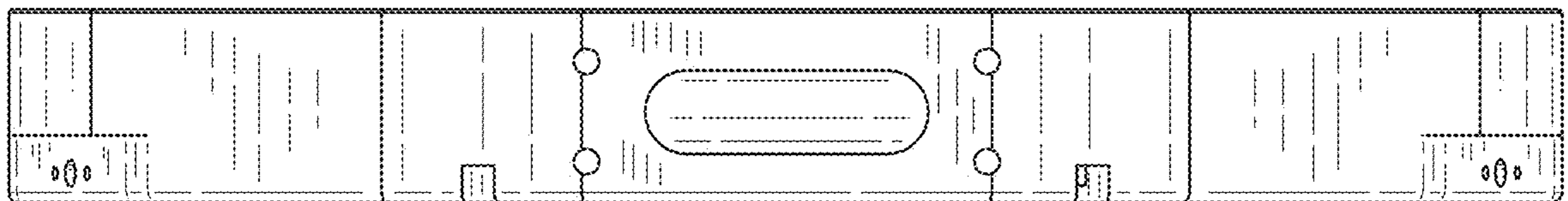

FIG. 6

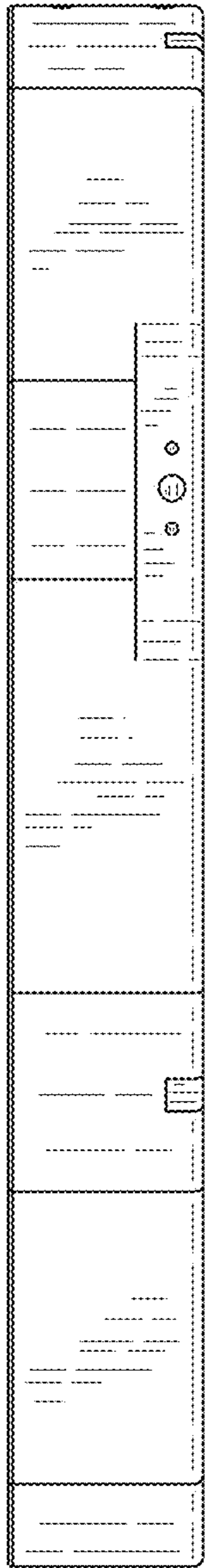

FIG. 7

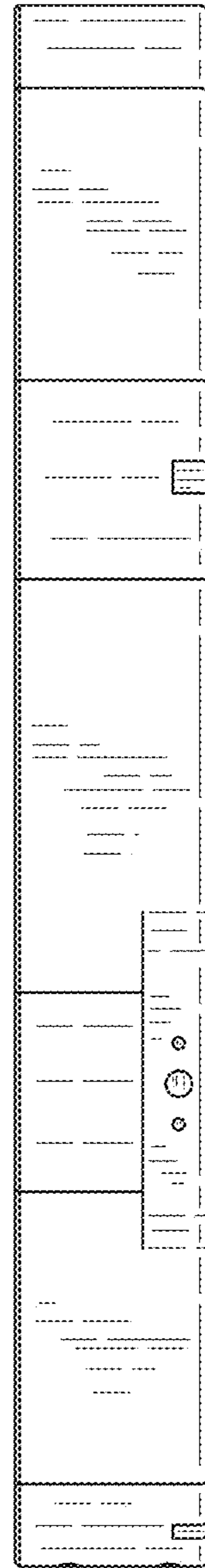

FIG. 8

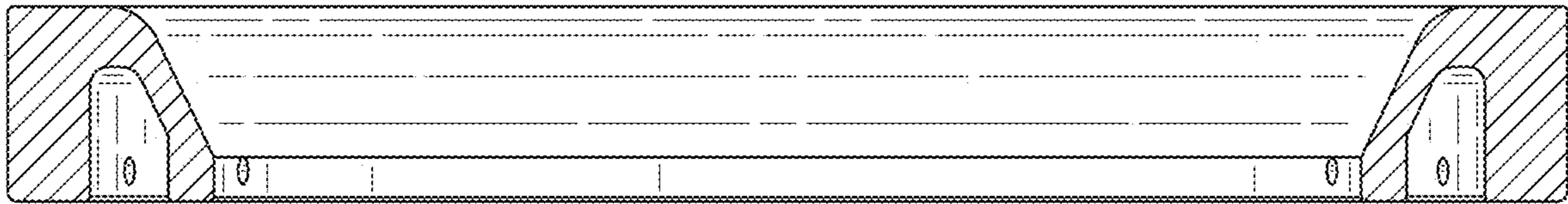

FIG.9