



US00D949307S

(12) **United States Design Patent** (10) **Patent No.:** **US D949,307 S**  
**Yang et al.** (45) **Date of Patent:** **\*\* Apr. 19, 2022**

(54) **DEHUMIDIFIER**

D925,024 S \* 7/2021 Huang ..... D23/356  
D933,797 S \* 10/2021 Liu ..... D23/364  
2013/0149200 A1\* 6/2013 Hong ..... B03C 3/12  
422/122

(71) Applicant: **GD MIDEA AIR-CONDITIONING EQUIPMENT CO., LTD.**, Foshan (CN)

(Continued)

(72) Inventors: **Yongyi Yang**, Foshan (CN); **Jialong Luo**, Foshan (CN)

FOREIGN PATENT DOCUMENTS

CN 305949933 \* 7/2020  
CN 306211382 \* 12/2020

(73) Assignee: **GD MIDEA AIR-CONDITIONING EQUIPMENT CO., LTD.**, Foshan (CN)

OTHER PUBLICATIONS

Blue Pure 211 + Air Purifier, first available Jan. 5, 2017[online], [site visited Nov. 12, 2021]. Available from internet, URL:<https://www.amazon.ca/dp/B073WJL99W> (Year: 2017).\*

(\*\*) Term: **15 Years**

(Continued)

(21) Appl. No.: **29/741,097**

(22) Filed: **Jul. 9, 2020**

*Primary Examiner* — Barbara Fox

*Assistant Examiner* — Jamaal Rasheed

(30) **Foreign Application Priority Data**

Jan. 19, 2020 (CN) ..... 202030037746.6

(74) *Attorney, Agent, or Firm* — Anova Law Group PLLC

(51) **LOC (13) Cl.** ..... **23-04**

(57) **CLAIM**

The ornamental design for a dehumidifier, as shown and described.

(52) **U.S. Cl.**

USPC ..... **D23/359**

**DESCRIPTION**

(58) **Field of Classification Search**

USPC ..... D23/356, 359, 364–365, 378, 499

CPC ..... F24F 3/16; F24F 3/1405; F24F 3/1603;

F24F 13/20; F24F 13/222

See application file for complete search history.

FIG. 1 is a front elevational view of a dehumidifier showing our new design:

FIG. 2 is a rear elevational view thereof;

FIG. 3 is a left-side elevational view thereof;

FIG. 4 is a right-side elevational view thereof

FIG. 5 is a top view thereof;

FIG. 6 is a bottom view thereof;

FIG. 7 is a left-front perspective view thereof;

FIG. 8 is a right-rear perspective view thereof; and,

FIG. 9 is a left-front perspective view of the dehumidifier shown in a retracted configuration.

The broken lines shown in the drawings are for the purpose of illustrating portions of the dehumidifier that form no part of the claimed design.

(56) **References Cited**

U.S. PATENT DOCUMENTS

D865,148 S \* 10/2019 Yoon ..... D23/364

D878,531 S \* 3/2020 Shin ..... D23/364

D888,918 S \* 6/2020 Seo ..... D23/356

D912,796 S \* 3/2021 Huang ..... D23/364

D917,683 S \* 4/2021 Xie ..... D23/359

D918,366 S \* 5/2021 Li ..... D23/359

D924,385 S \* 7/2021 Liu ..... F24F 13/20  
D23/356

**1 Claim, 9 Drawing Sheets**

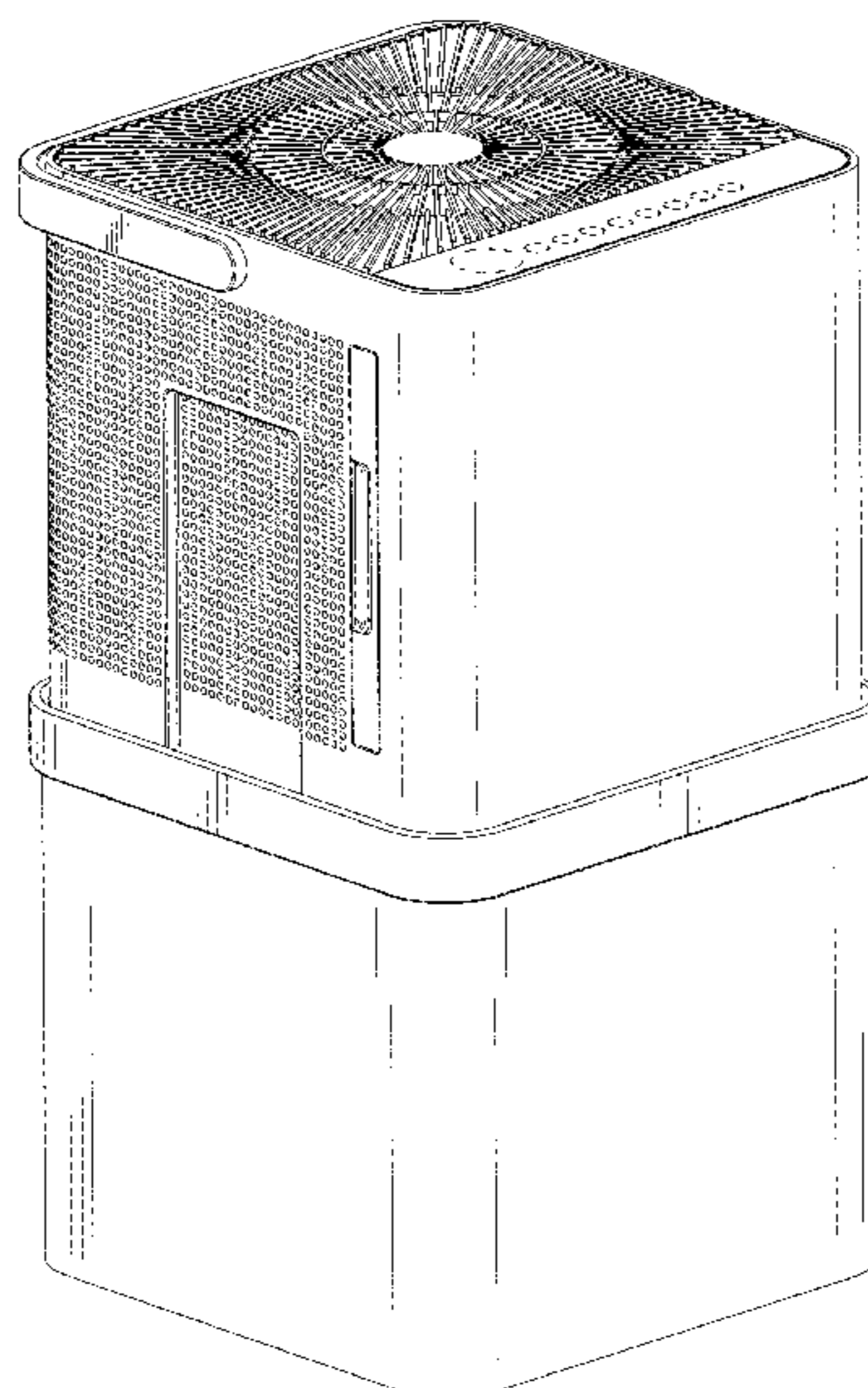

(56)

**References Cited**

U.S. PATENT DOCUMENTS

2015/0231543 A1\* 8/2015 Wennerstrom ..... F24F 13/28  
96/57  
2018/0221805 A1\* 8/2018 Bae ..... B01D 46/009  
2021/0129070 A1\* 5/2021 Han ..... A61L 9/205  
2021/0332990 A1\* 10/2021 Yang ..... F24F 1/0358  
2021/0333010 A1\* 10/2021 Yang ..... F24F 1/0358

OTHER PUBLICATIONS

Blue Pure 121 Air Purifier, first available Apr. 7, 2018[online], [site visited Nov. 29, 2021]. Available from internet, URL:<<https://www.amazon.ca/Purifier-Washable-Pre-Filters-Particle-Allergens/dp/B073WJPK5H?th=1>> (Year: 2018).\*

\* cited by examiner

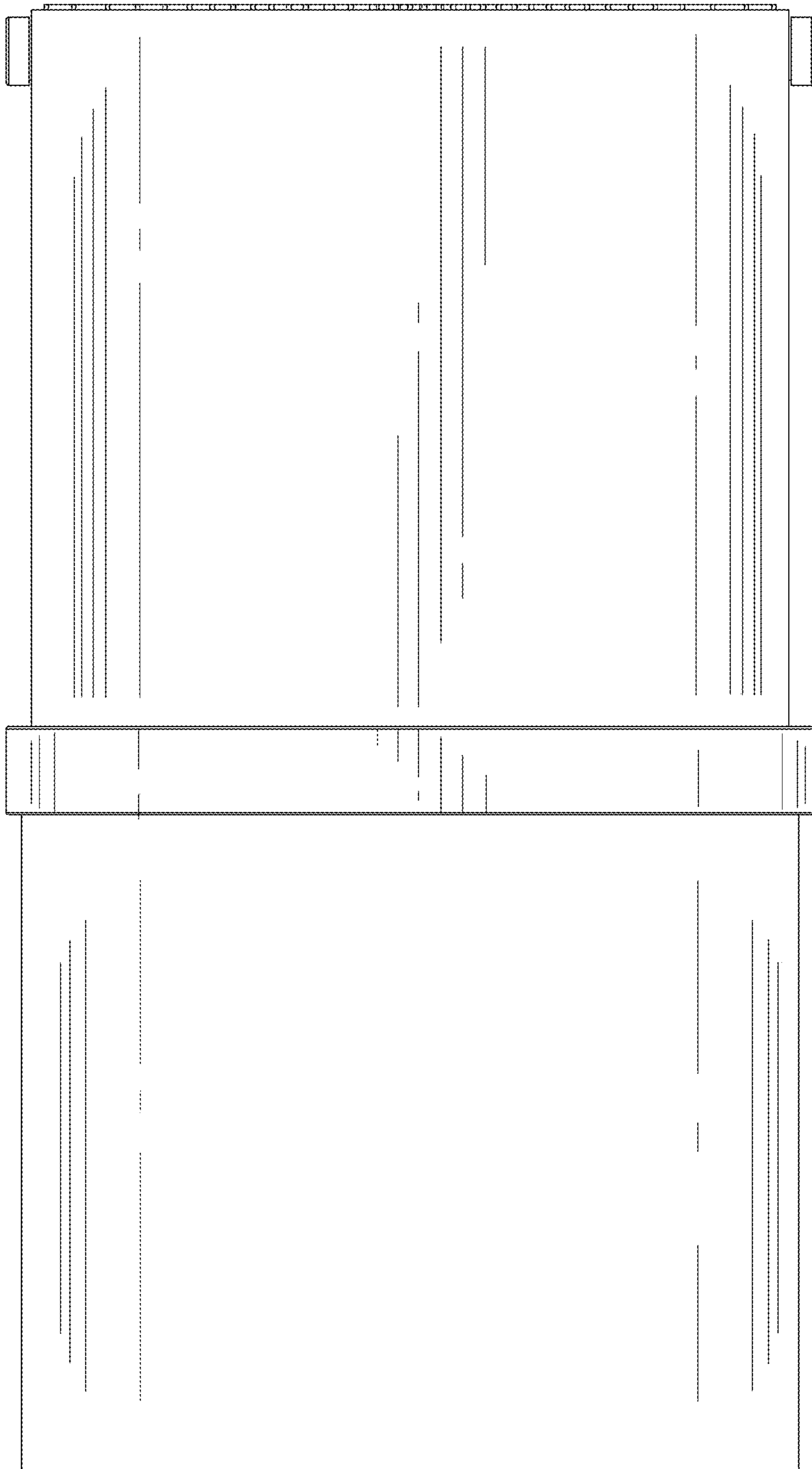

FIG. 1

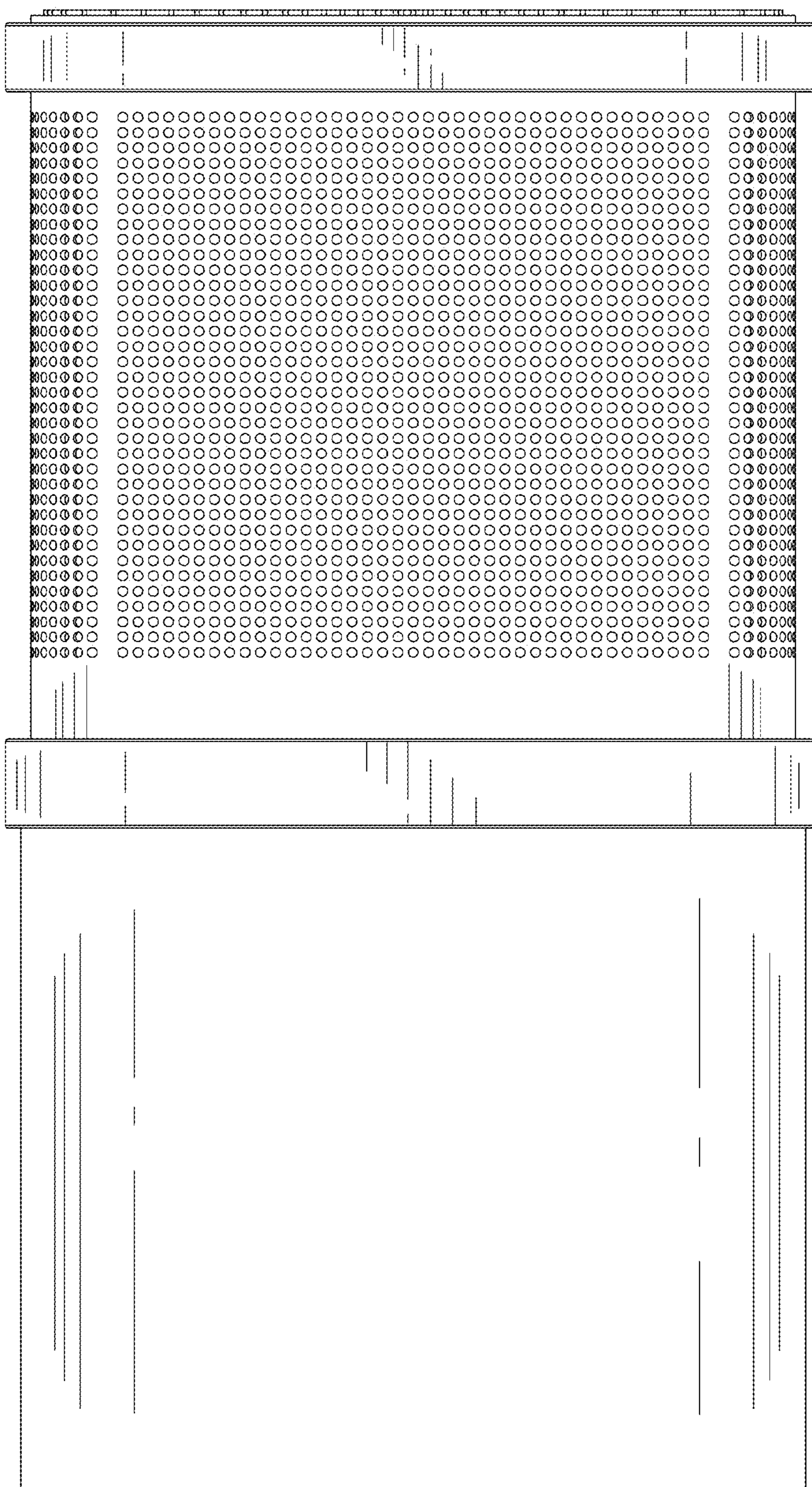

FIG. 2

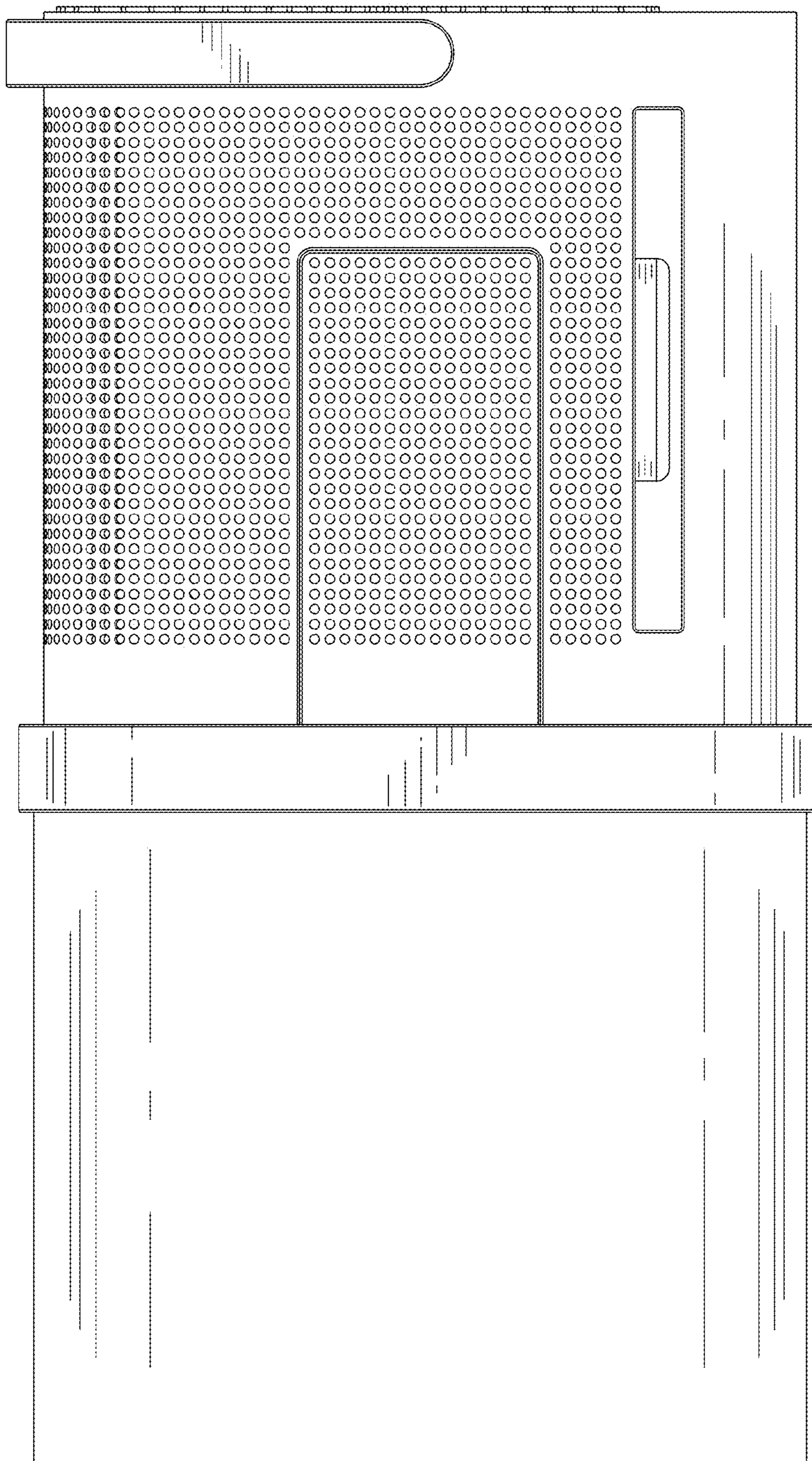

FIG. 3

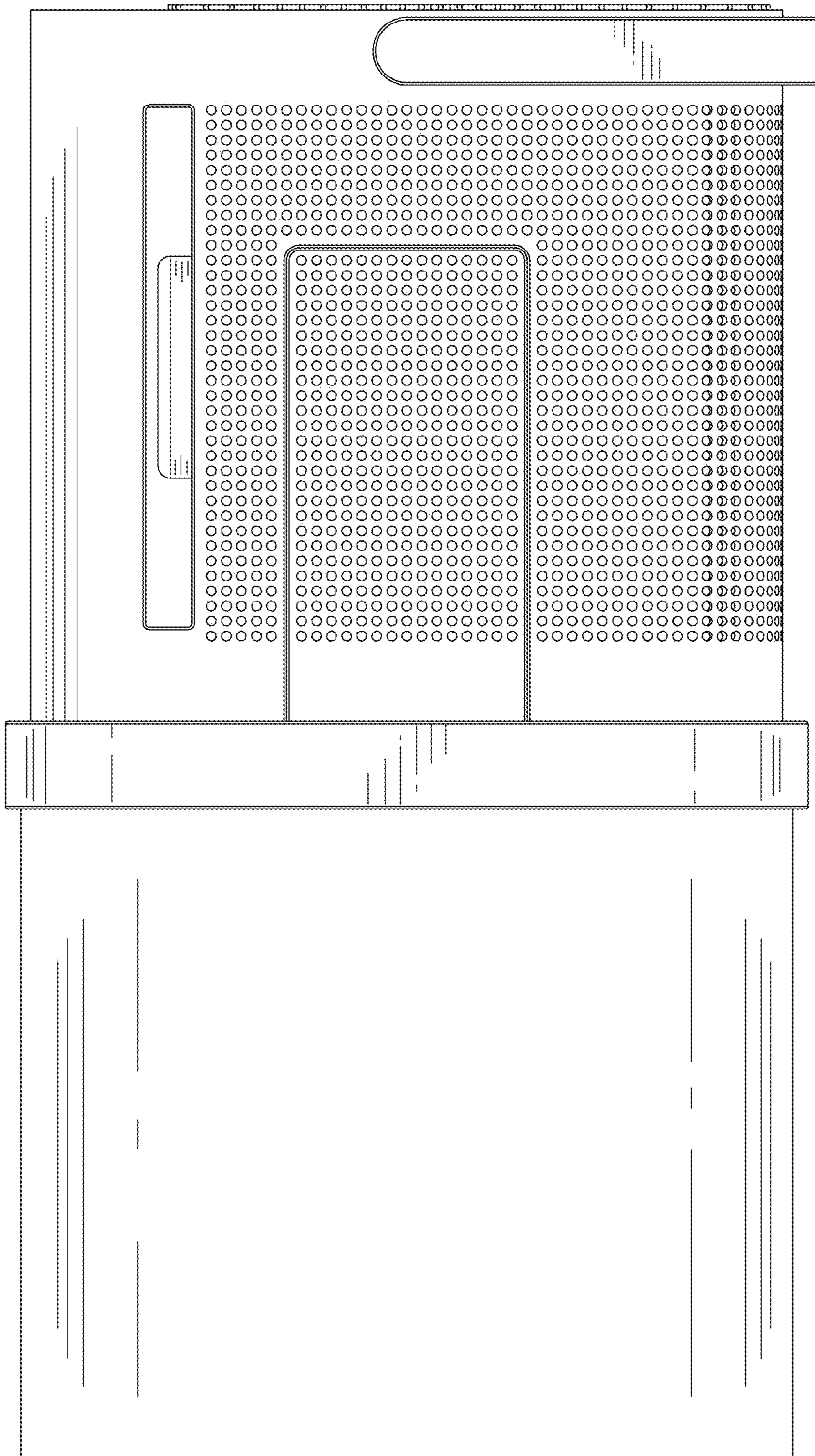

FIG. 4

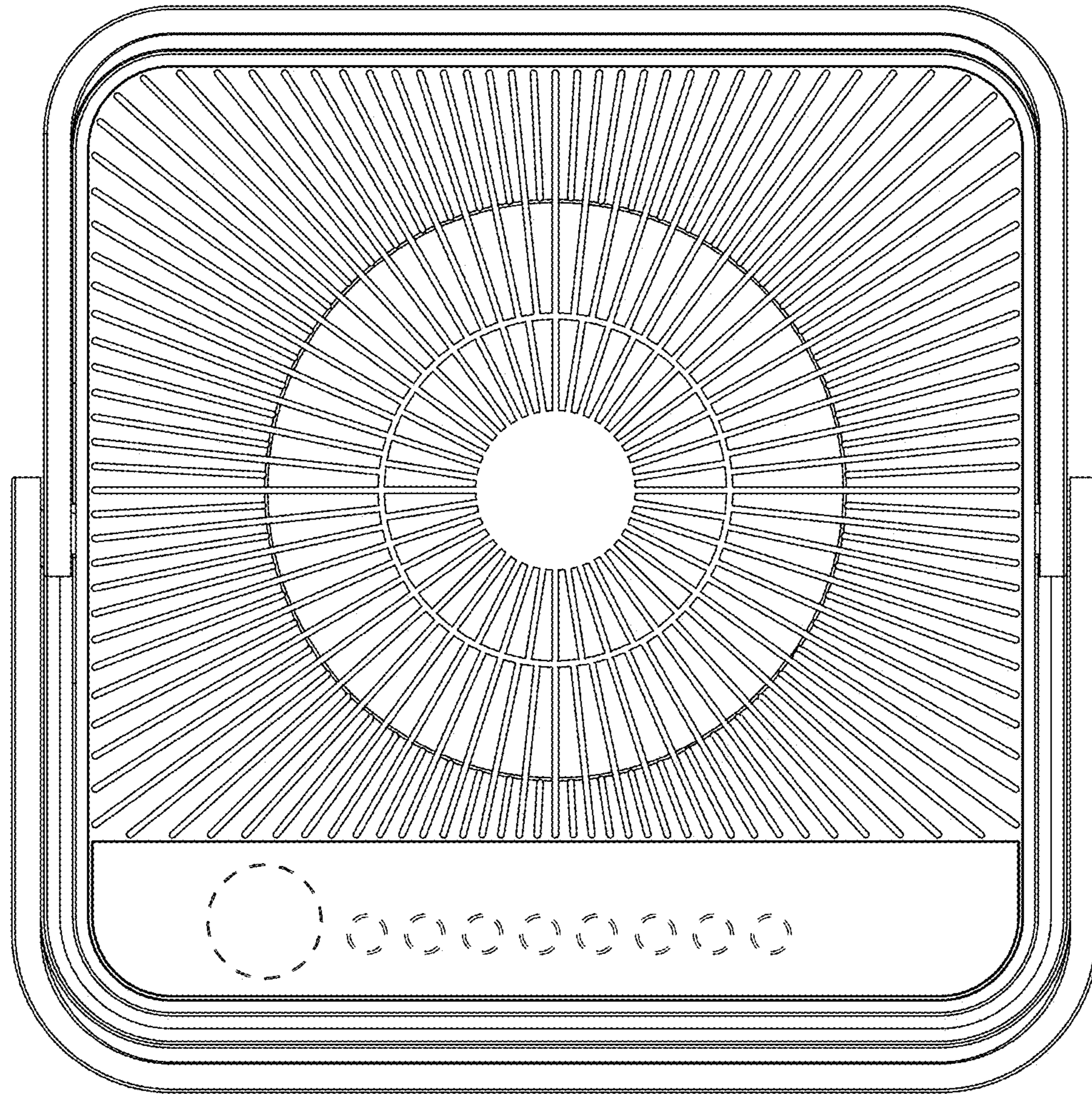

FIG. 5

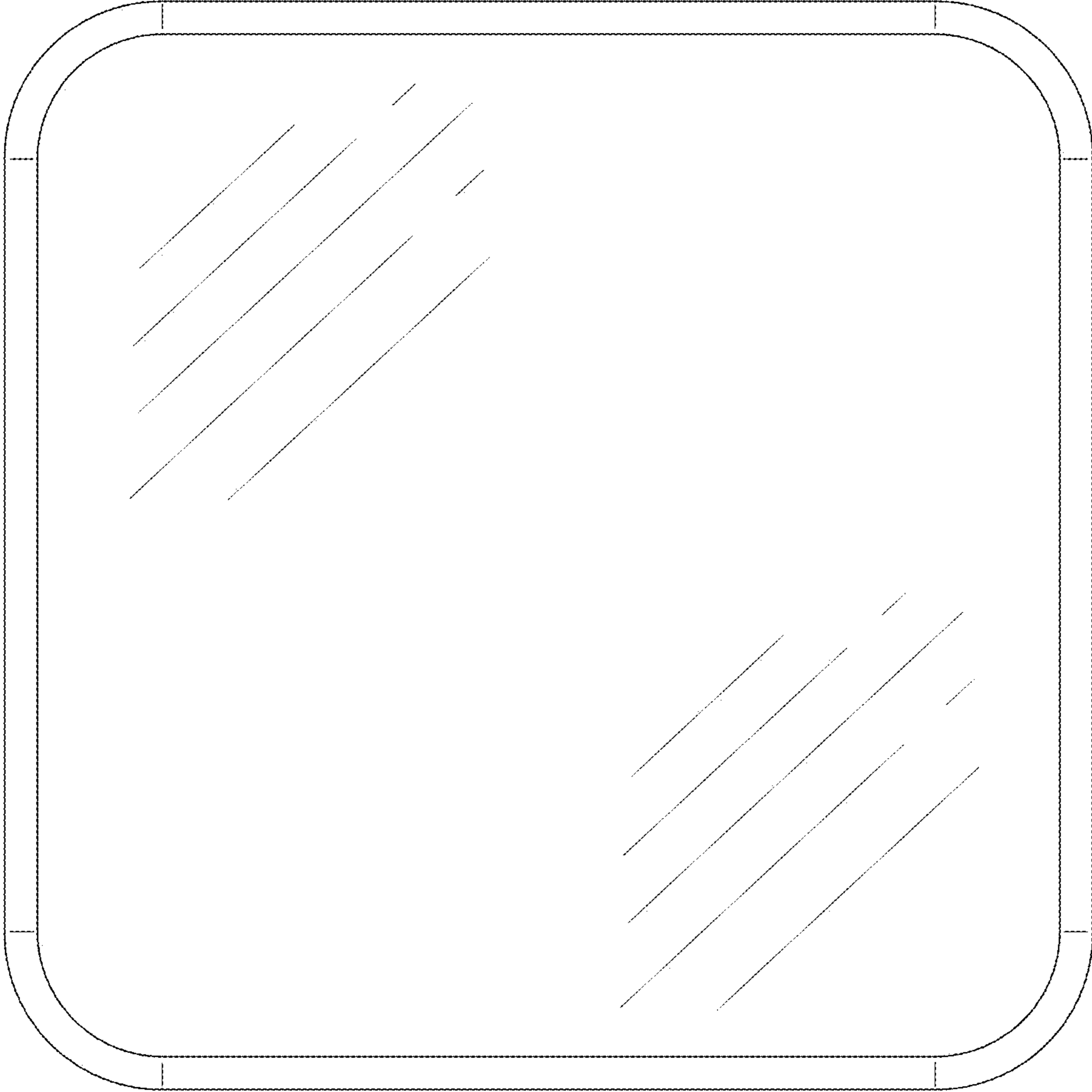

FIG. 6



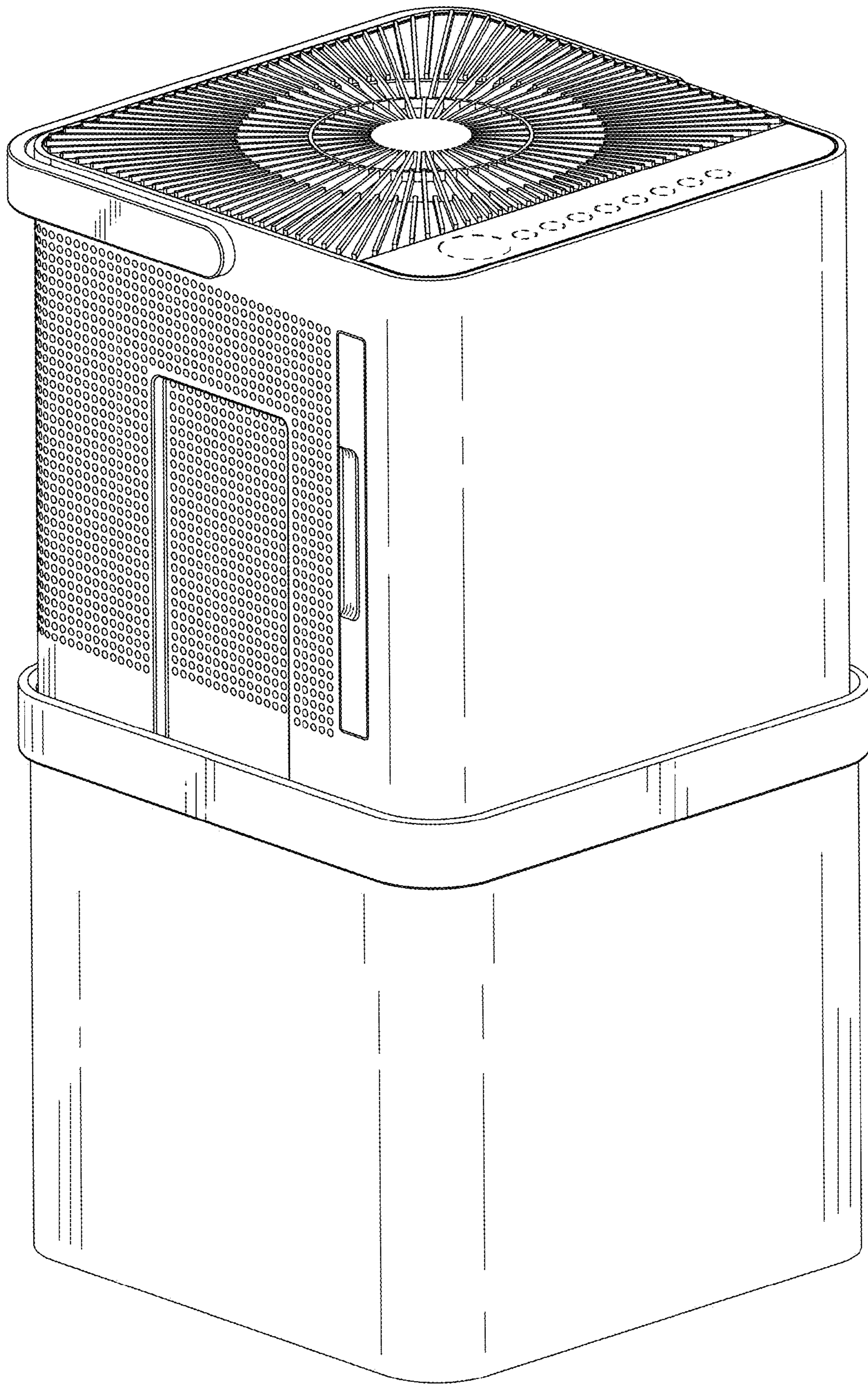

FIG. 7

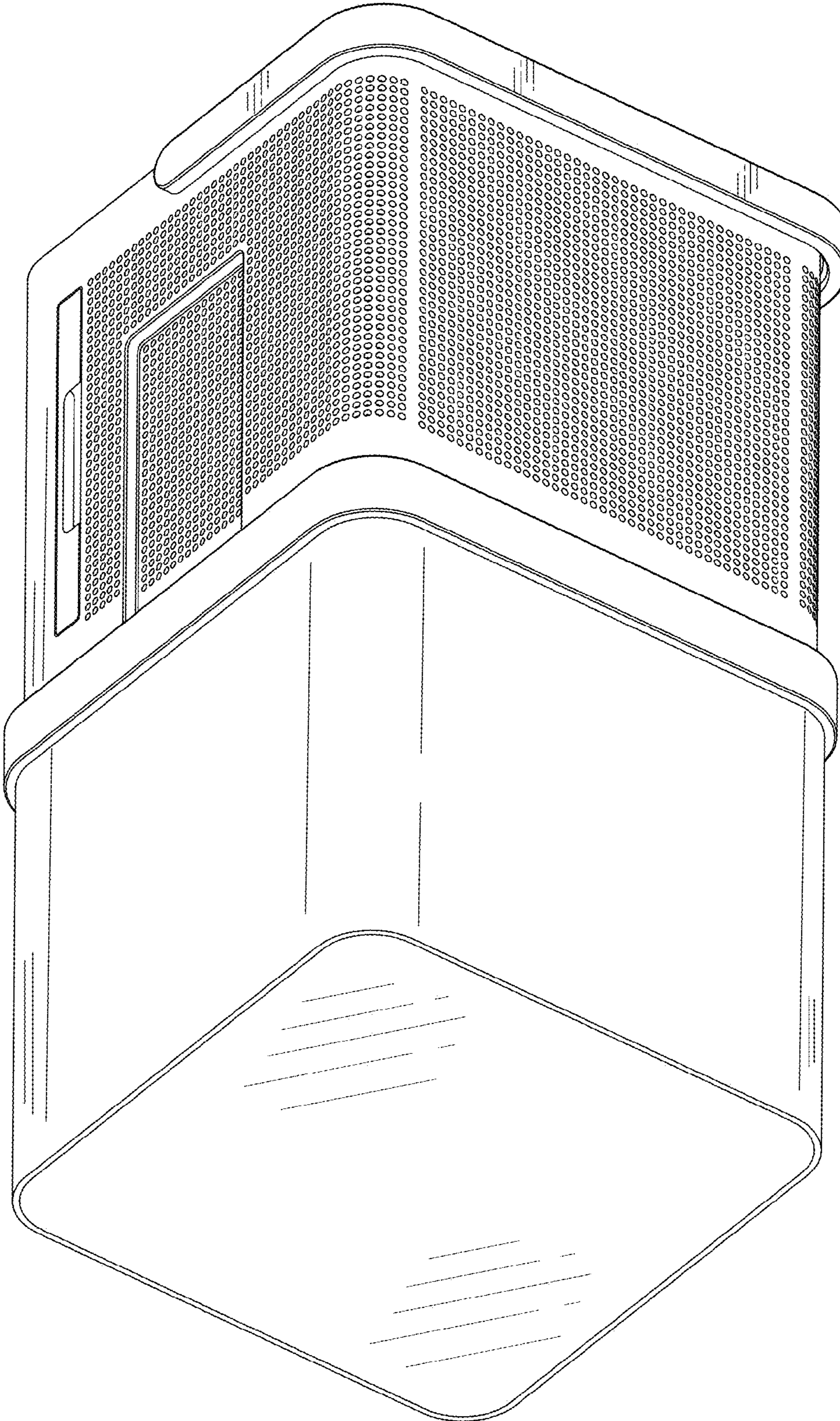

FIG. 8

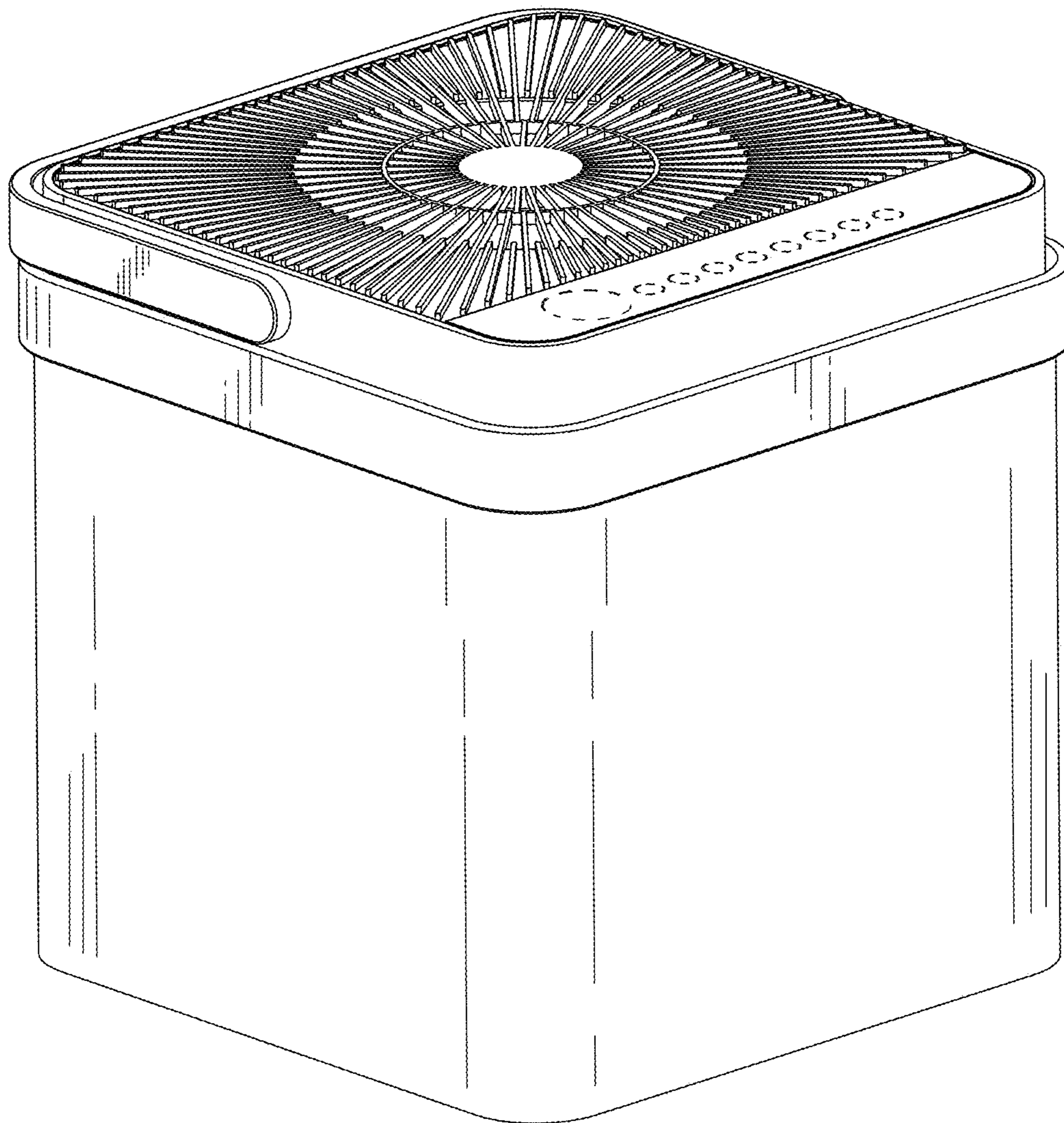

FIG. 9