



US00D949291S

(12) **United States Design Patent**  
**Fang**

(10) **Patent No.:** **US D949,291 S**

(45) **Date of Patent:** **\*\* Apr. 19, 2022**

(54) **WATER SPRAY-TYPE TOY**

(71) Applicant: **Zhicheng Fang**, Shantou (CN)

(72) Inventor: **Zhicheng Fang**, Shantou (CN)

(\*\*) Term: **15 Years**

(21) Appl. No.: **29/780,732**

(22) Filed: **Apr. 26, 2021**

(30) **Foreign Application Priority Data**

Feb. 2, 2021 (CN) ..... 202130074205.5

(51) **LOC (13) Cl.** ..... **23-01**

(52) **U.S. Cl.**  
USPC ..... **D23/222**

(58) **Field of Classification Search**  
USPC ..... D21/597-612; D23/201, 213-214, 222,  
D23/229, 234, 255, 283, 312  
CPC ..... A61H 9/0021; A61H 33/00; A63H 3/00;  
A63H 7/06; A63H 11/20; A63H 33/04;  
A63H 33/08  
See application file for complete search history.

(56) **References Cited**

**U.S. PATENT DOCUMENTS**

D408,473 S *	4/1999	Millman	.....	D21/650
D485,872 S	1/2004	Yaschur		
D612,455 S *	3/2010	Henderson	.....	D23/255
D691,699 S *	10/2013	Berger	.....	D23/213
D716,381 S *	10/2014	Lo	.....	D21/401
D753,775 S *	4/2016	Majure Maysan	.....	D21/597
D768,245 S *	10/2016	Matthews	.....	D21/601
D772,991 S	11/2016	Caubel et al.		
D888,162 S *	6/2020	Fang	.....	D21/452
D889,607 S *	7/2020	Jin	.....	D23/255

D922,502 S *	6/2021	Bearsch	.....	D21/578
D924,356 S *	7/2021	Lin	.....	D23/213
D928,286 S *	8/2021	Huang	.....	D23/214
D937,935 S *	12/2021	Cai	.....	D21/401

\* cited by examiner

*Primary Examiner* — Karen S Acker  
*Assistant Examiner* — Jonathan E Fiencke

(57) **CLAIM**

The ornamental design for a water spray-type toy, as shown and described.

**DESCRIPTION**

FIG. 1 is a perspective view of a water spray-type toy shown assembled;  
FIG. 2 is a front elevation perspective view of the first part of a water spray-type toy;  
FIG. 3 is a back elevation view thereof;  
FIG. 4 is a left side view thereof;  
FIG. 5 is a right side view thereof;  
FIG. 6 is a top plan view thereof; and  
FIG. 7 is a bottom plan view thereof.  
FIG. 8 is a perspective view thereof;  
FIG. 9 is a perspective view of second part of a water spray-type toy;  
FIG. 10 is a front elevation view thereof;  
FIG. 11 is a back elevation view thereof;  
FIG. 12 is a left side view thereof;  
FIG. 13 is a right side view thereof;  
FIG. 14 is a top plan view thereof; and,  
FIG. 15 is a bottom plan view thereof.  
The dashed or broken lines shown in the drawings depict portions of the water spray-type toy in which the design is embodied that form no part of the claimed design.

**1 Claim, 15 Drawing Sheets**

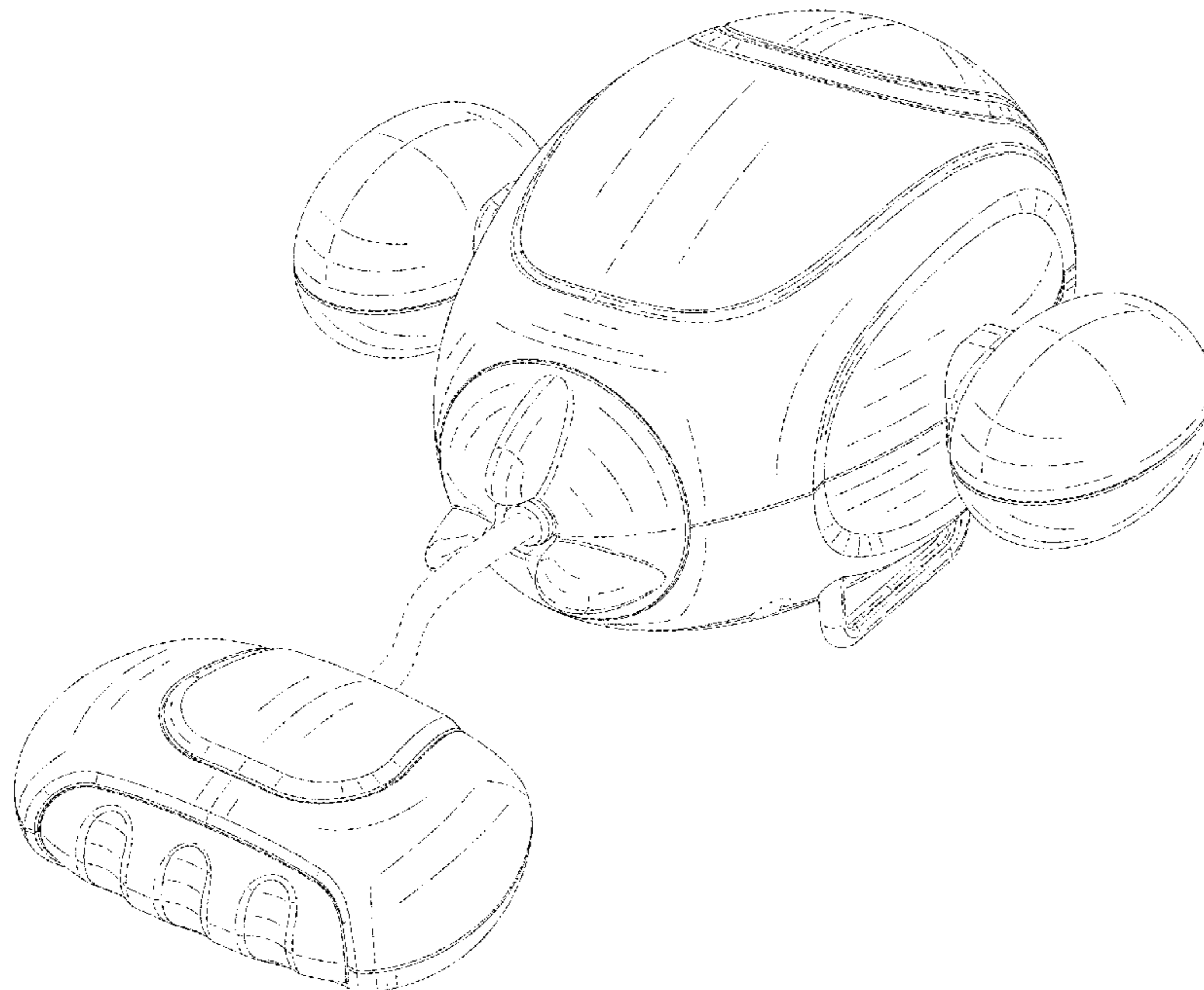

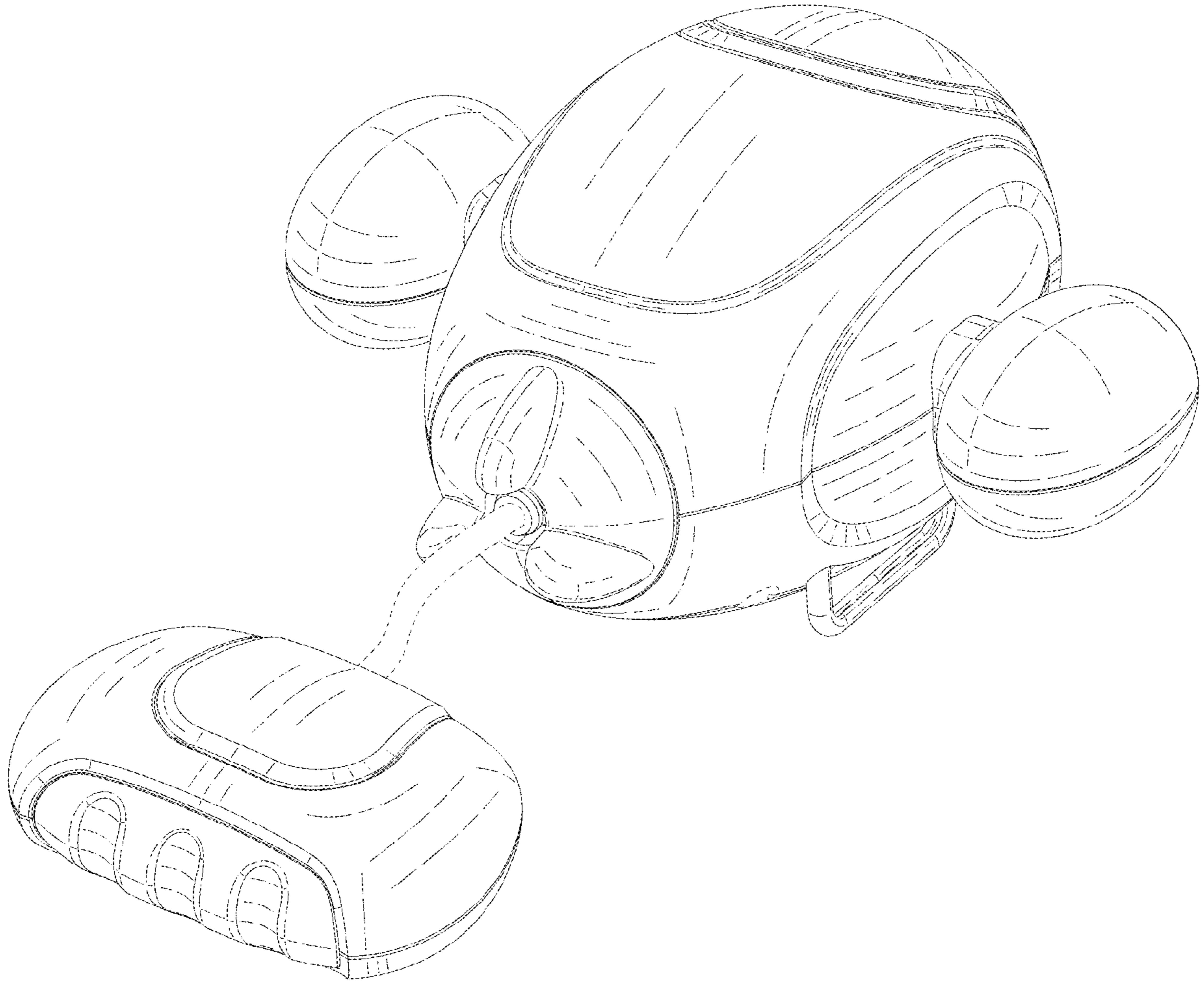

FIG. 1

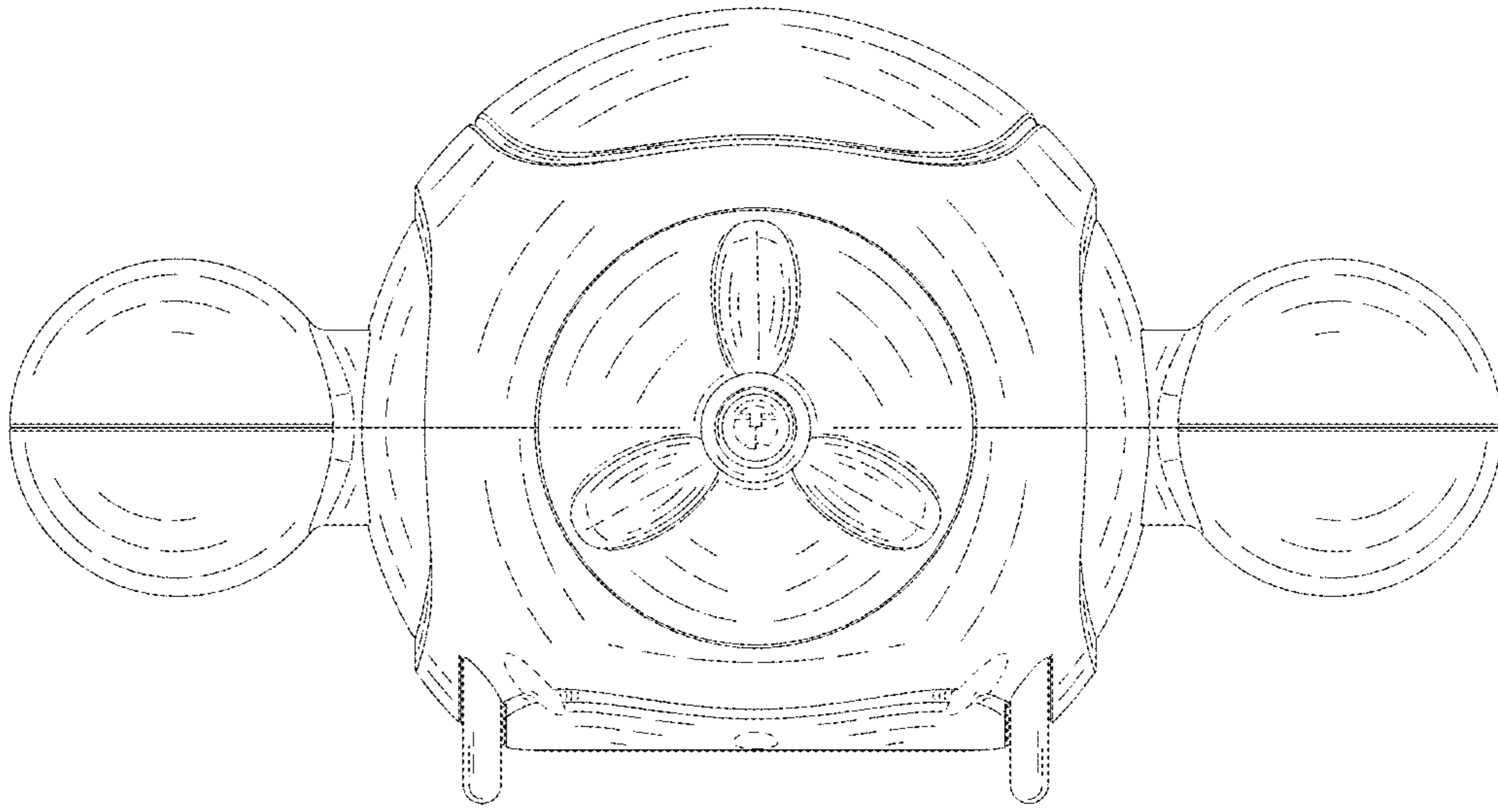

FIG. 2

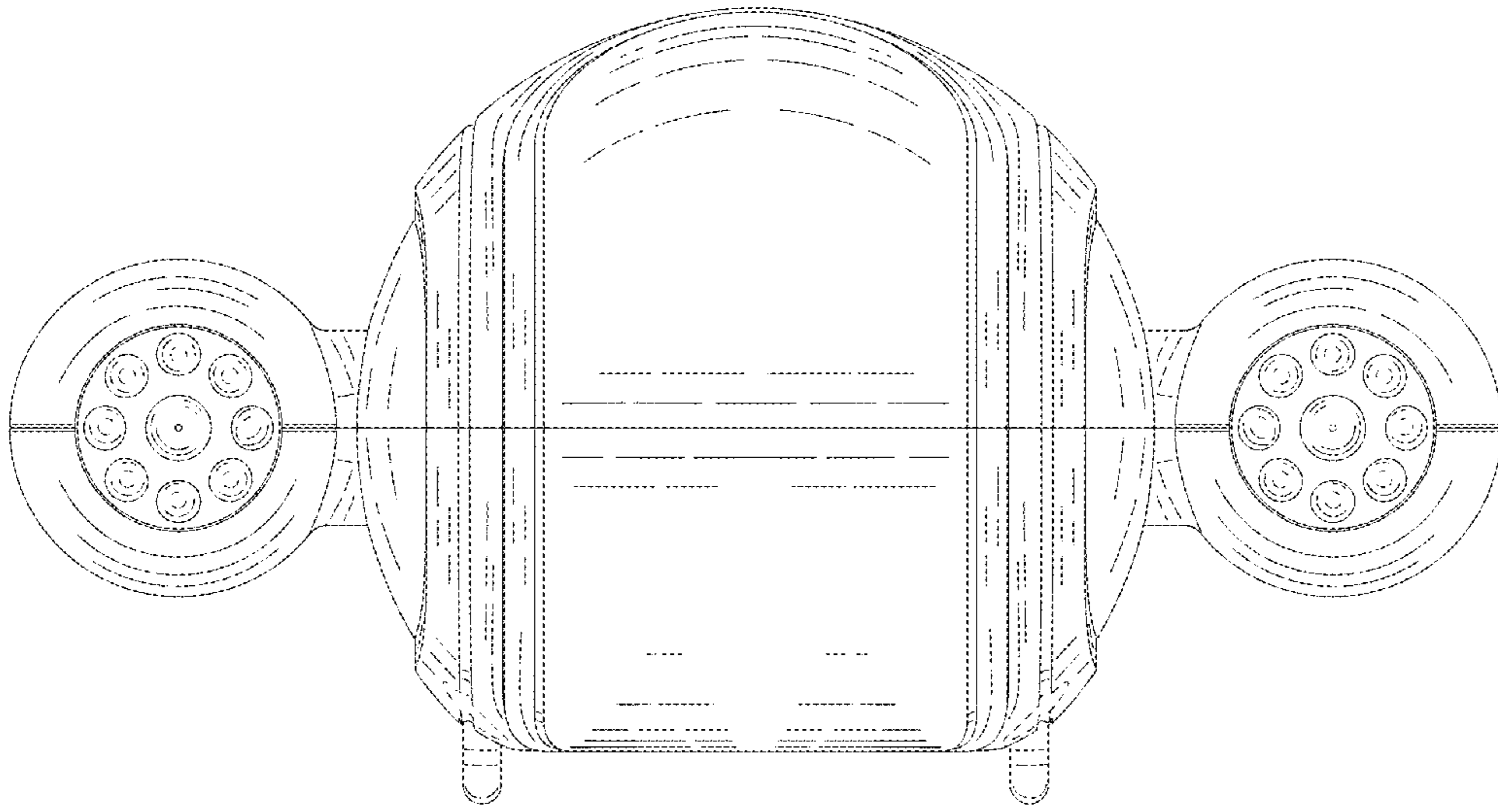

FIG. 3

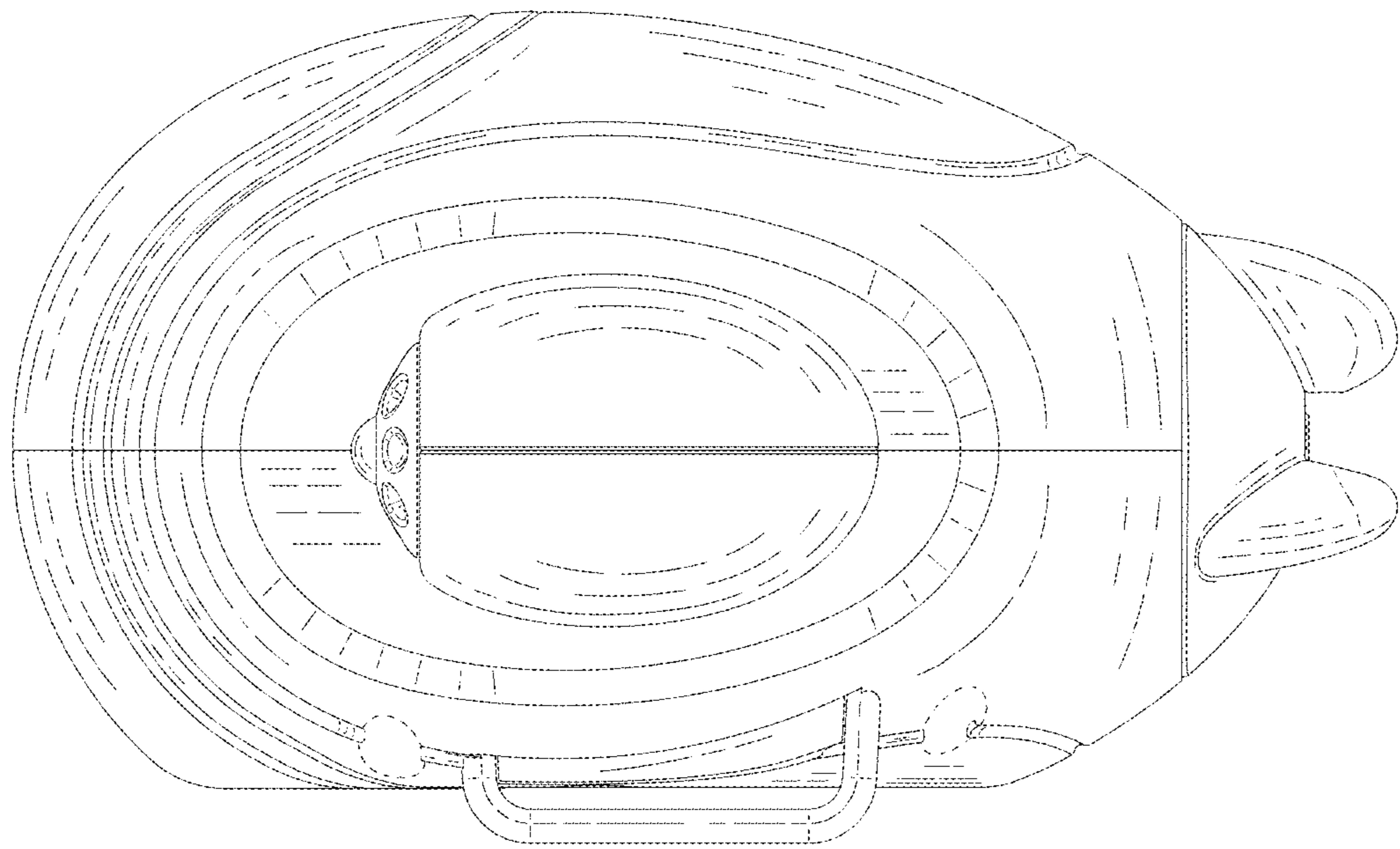

FIG. 4

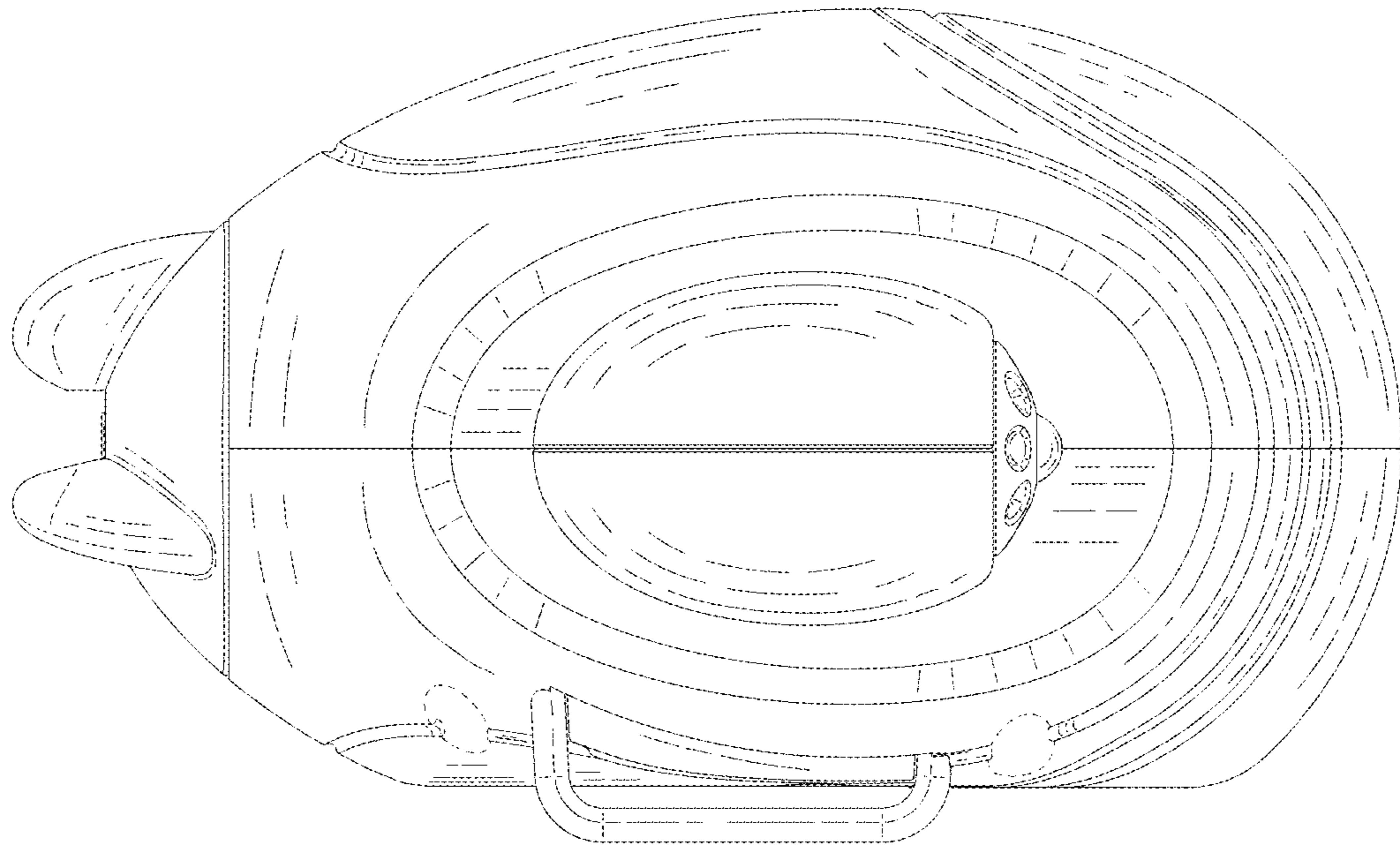

FIG. 5

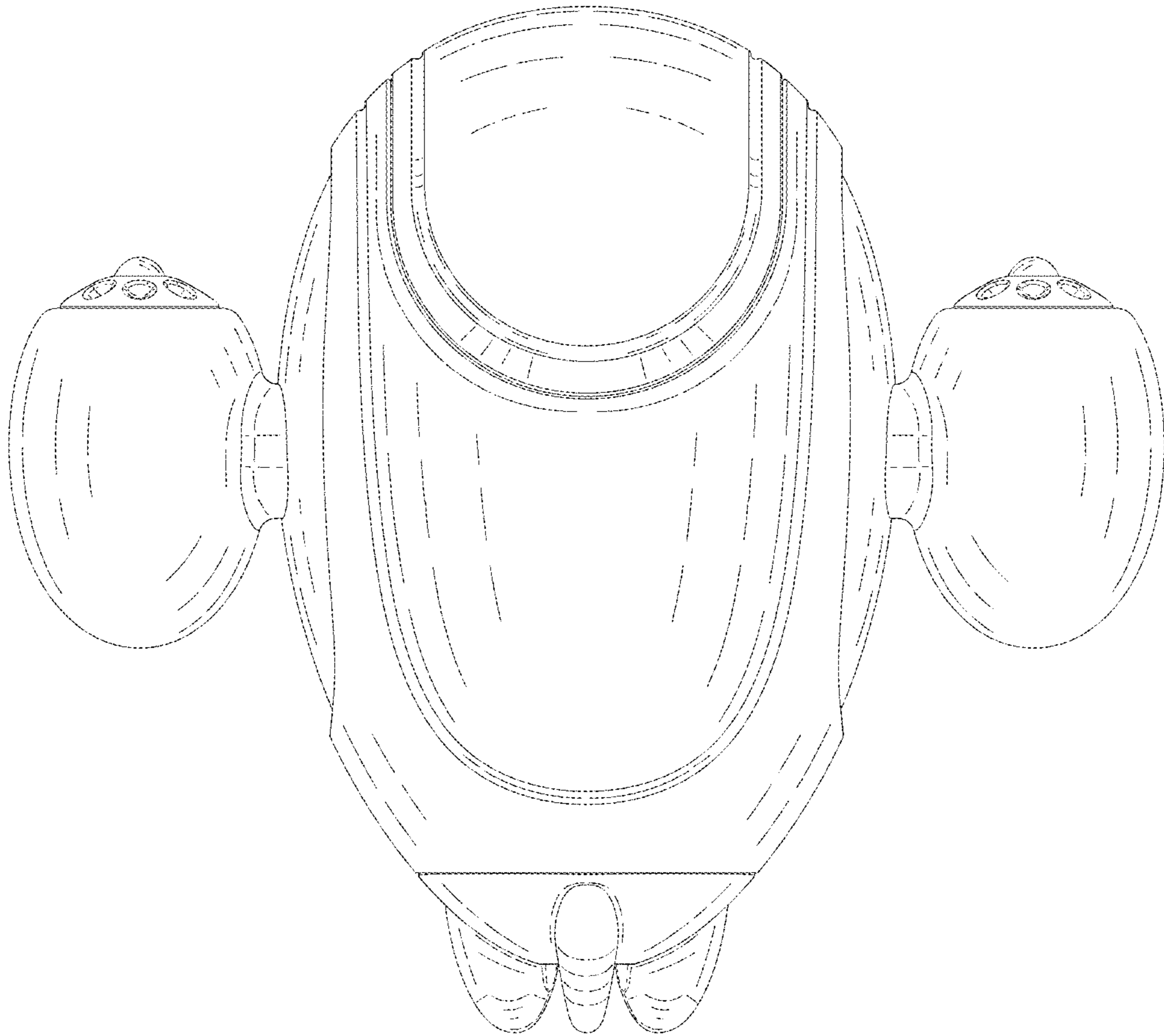

FIG. 6

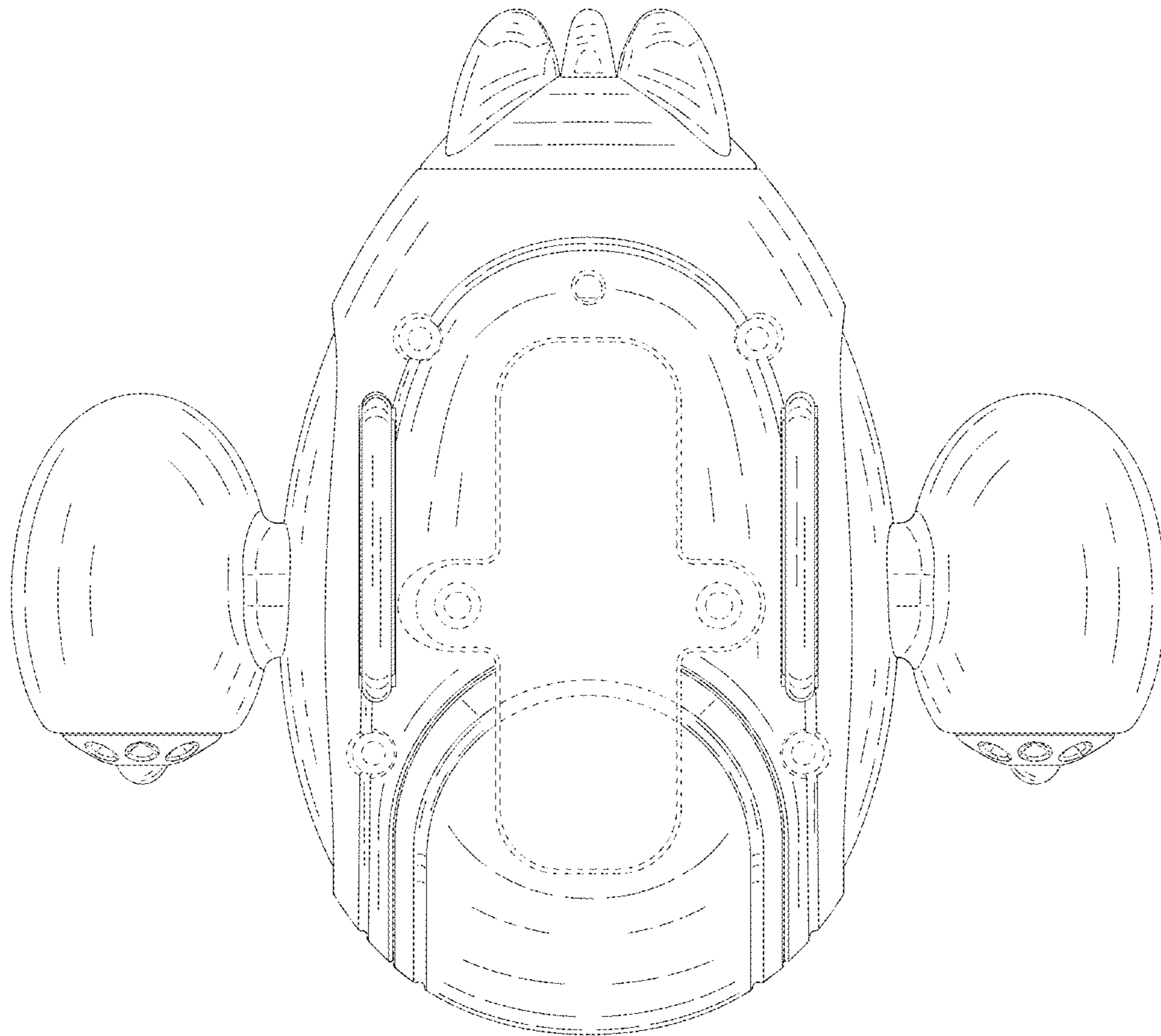

FIG. 7



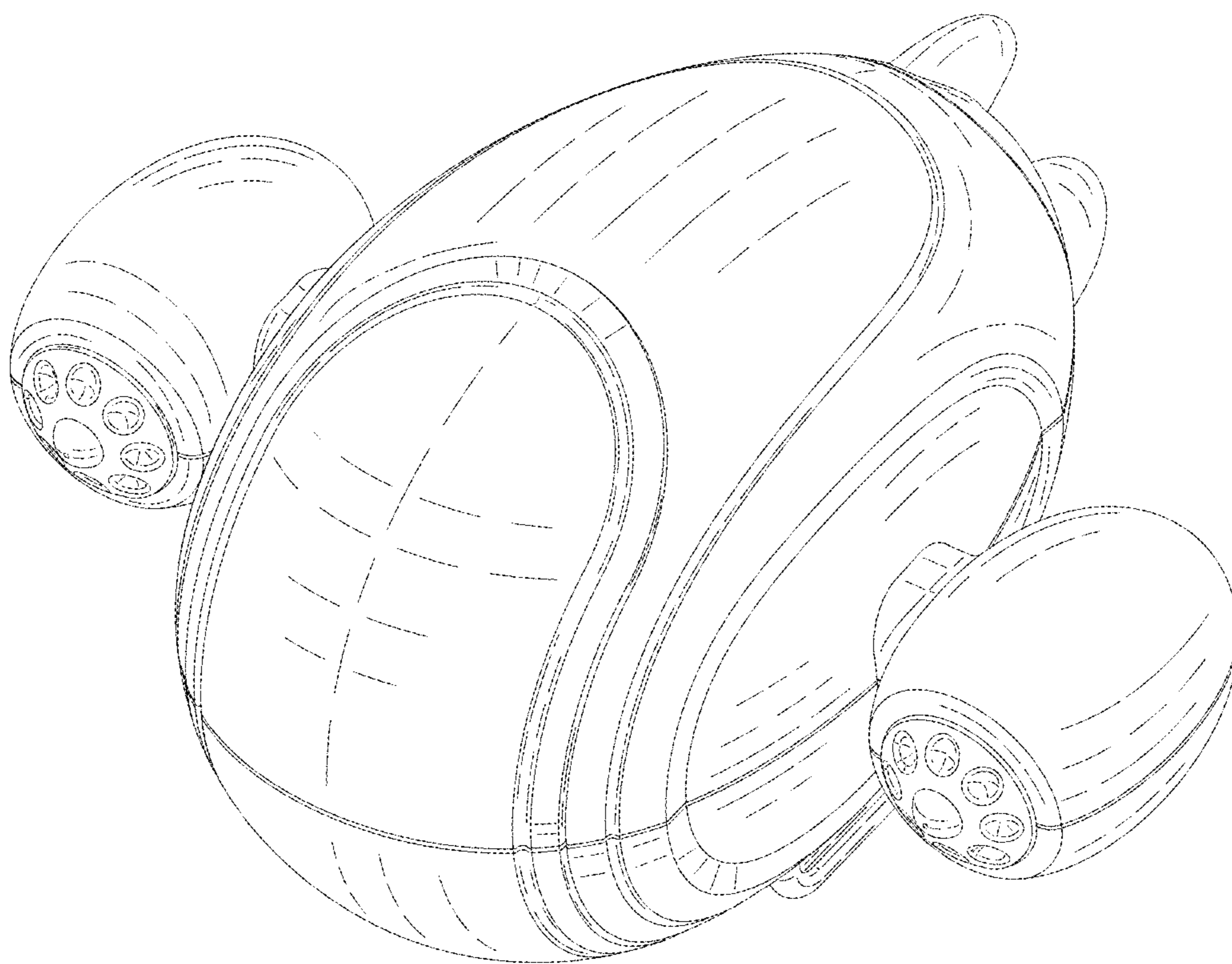

FIG. 8

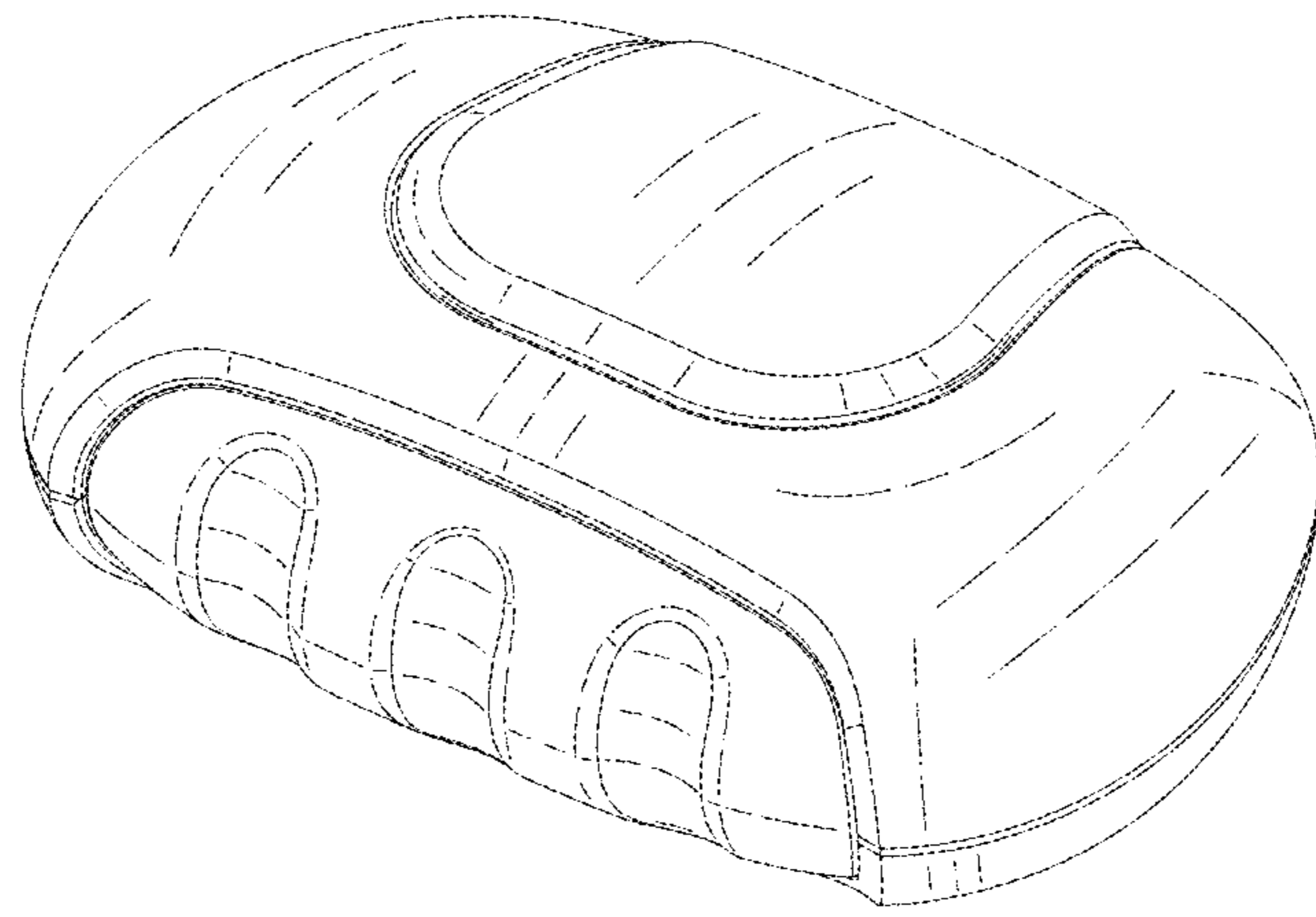

FIG. 9

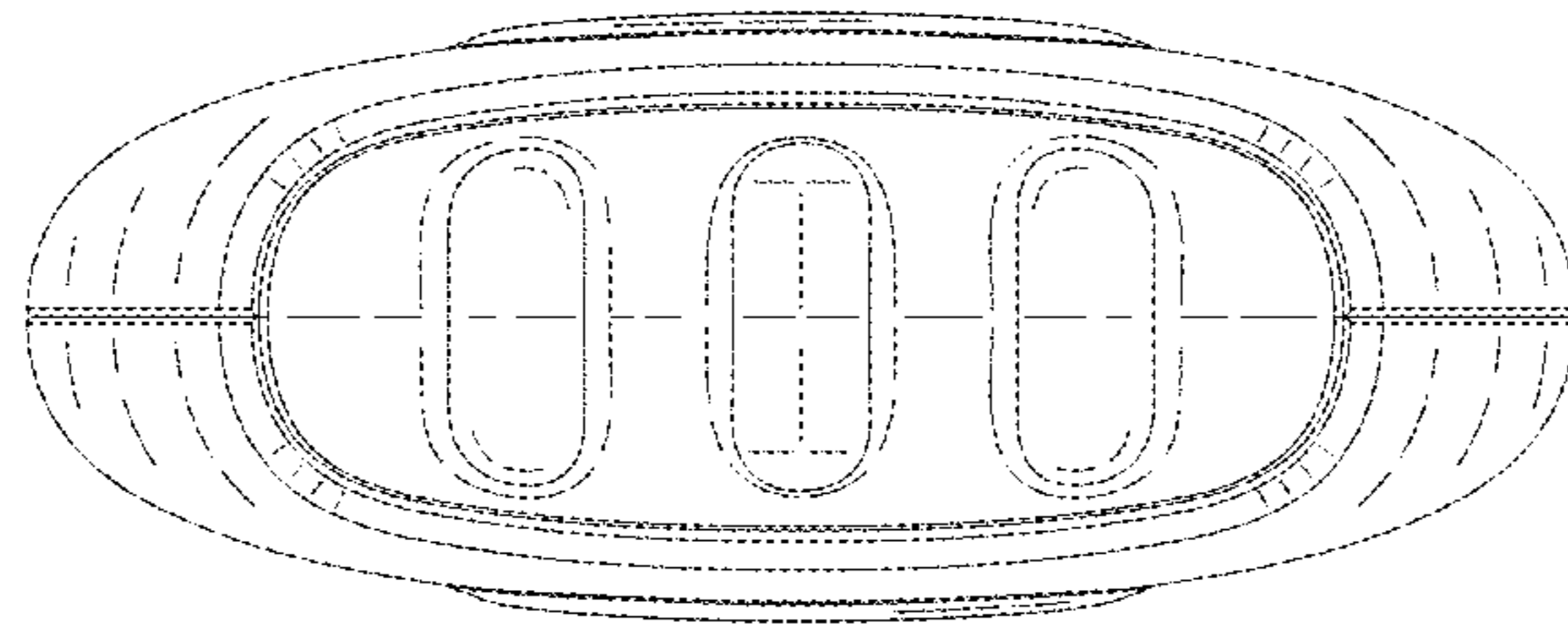

FIG. 10

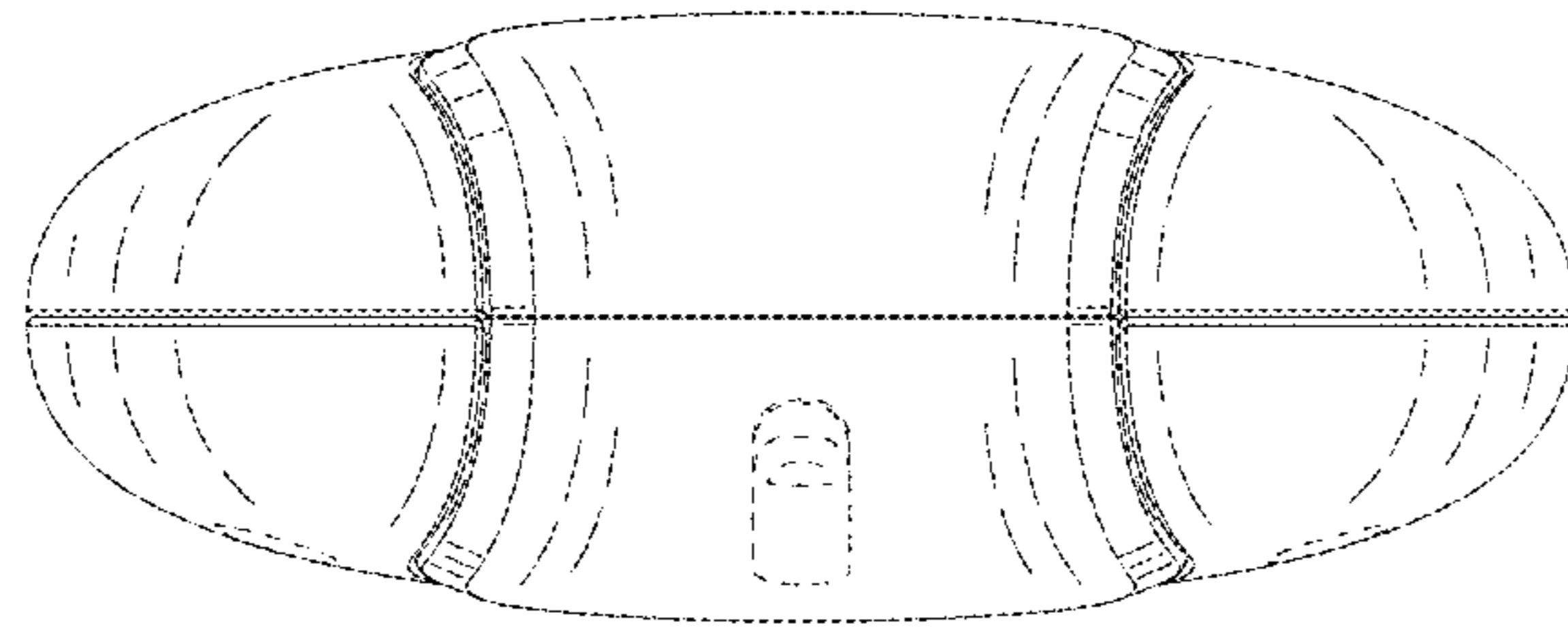

FIG. 11

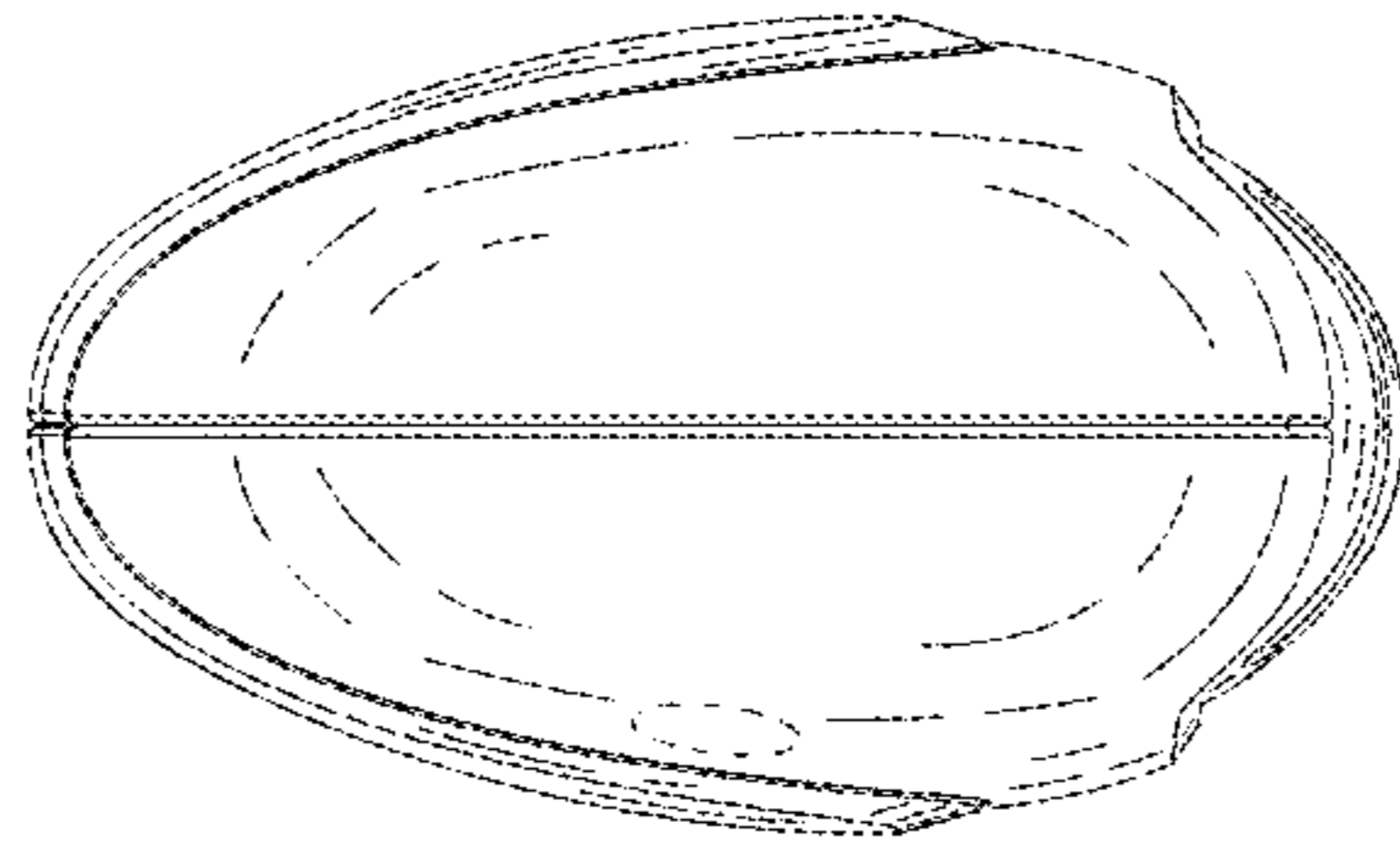

FIG. 12

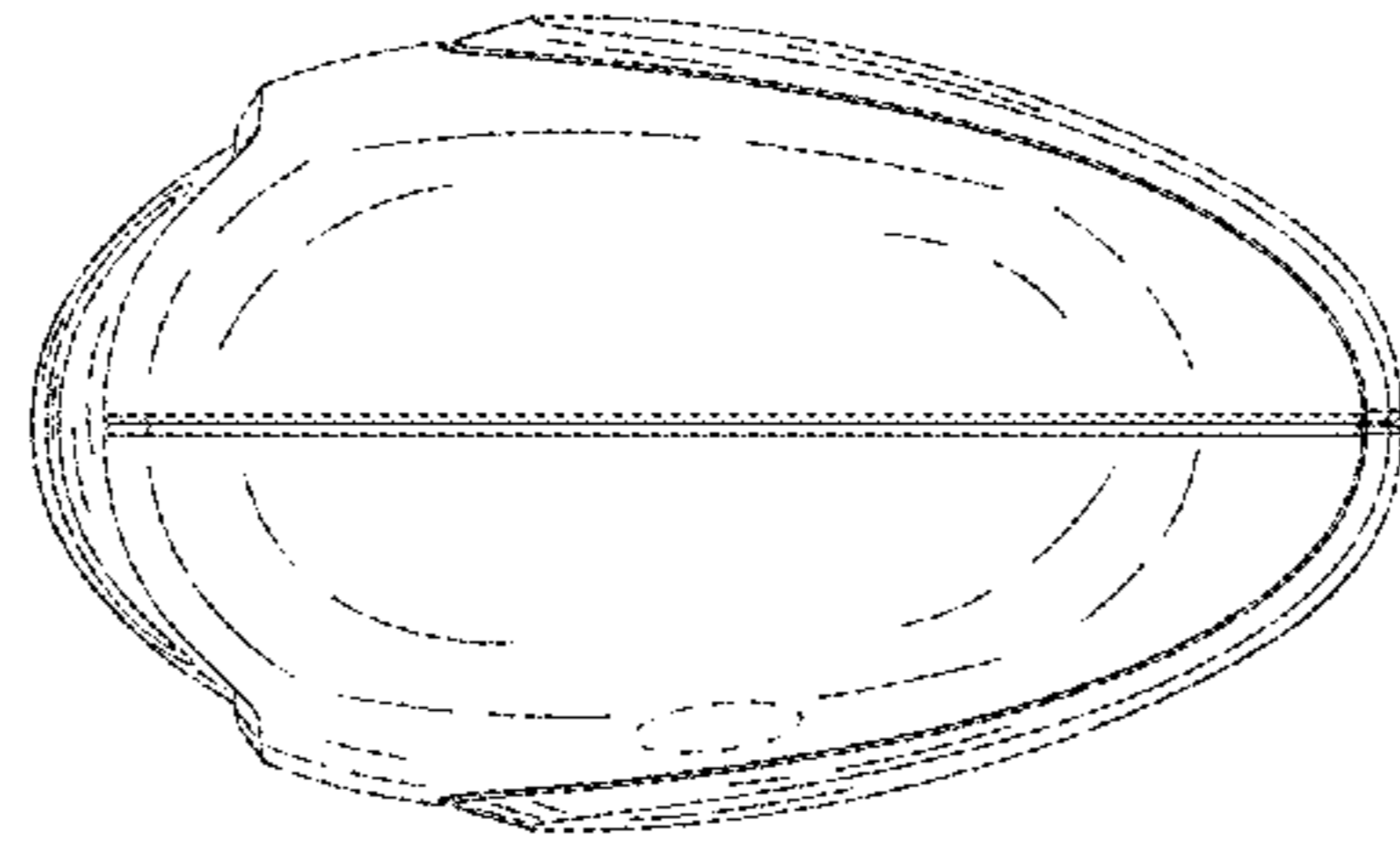

FIG. 13

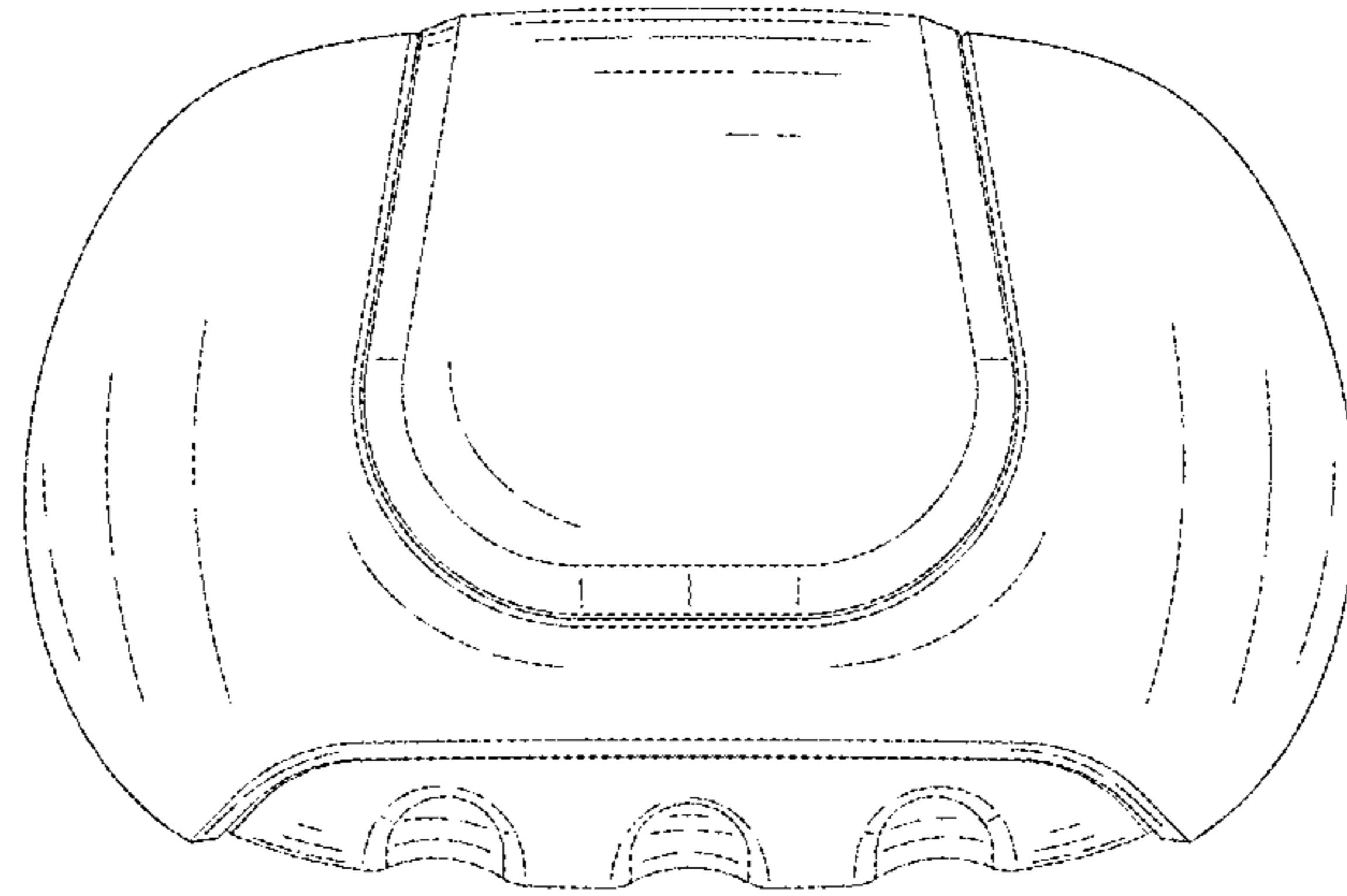

FIG. 14

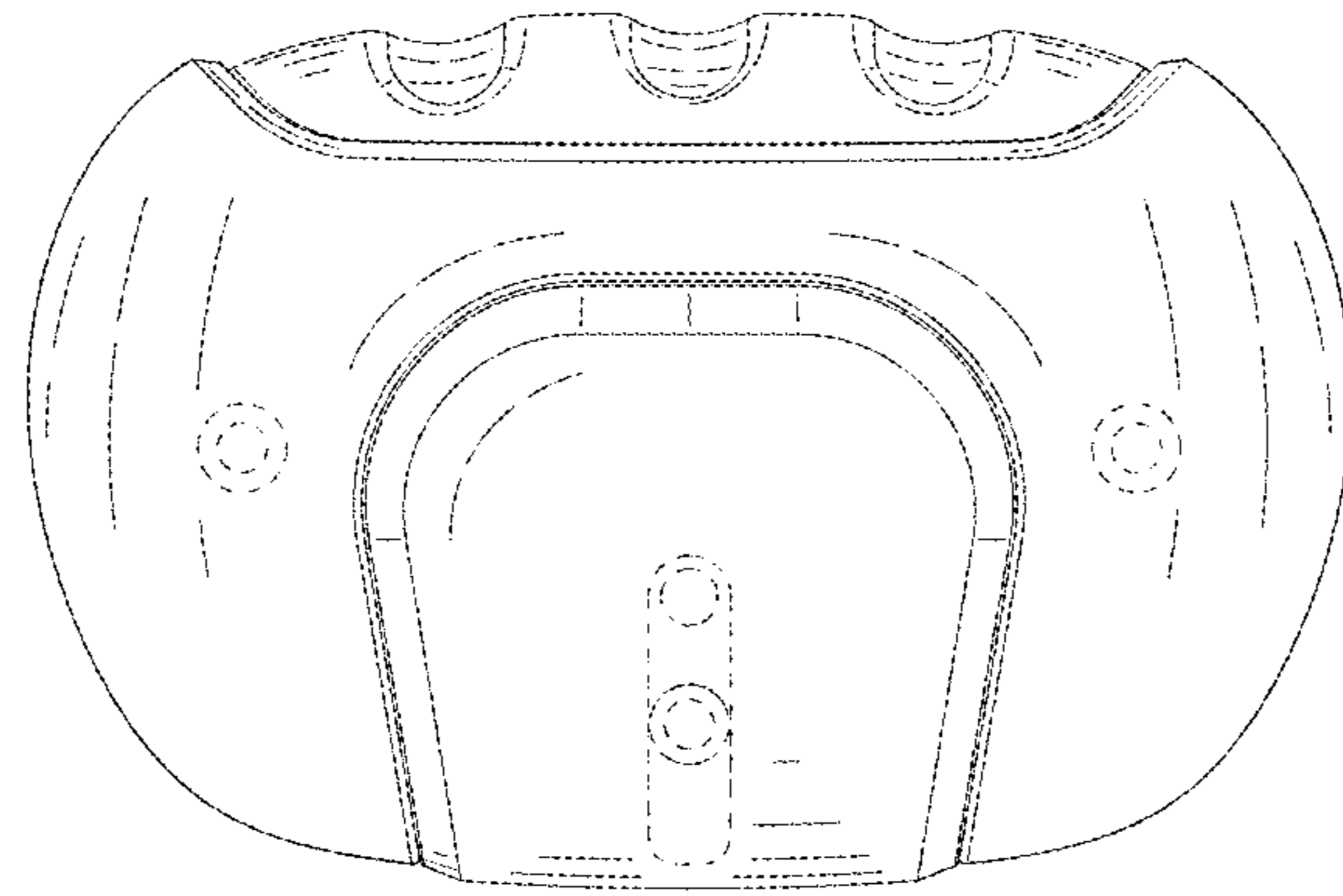

FIG. 15