



US00D949272S

(12) **United States Design Patent**  
**Parsons et al.**

(10) **Patent No.:** **US D949,272 S**  
(45) **Date of Patent:** **\*\* Apr. 19, 2022**

(54) **GOLF CLUB HEAD**

FOREIGN PATENT DOCUMENTS

(71) Applicant: **PARSONS XTREME GOLF, LLC**,  
Scottsdale, AZ (US)

CN 1572343 A 2/2005  
CN 1608696 A 4/2005

(Continued)

(72) Inventors: **Robert R. Parsons**, Scottsdale, AZ  
(US); **Bradley D. Schweigert**, Cave  
Creek, AZ (US); **Michael R. Nicolette**,  
Scottsdale, AZ (US)

*Primary Examiner* — Mitchell I. Siegel

(57) **CLAIM**

The ornamental design for a golf club head, as shown and  
described.

(73) Assignee: **PARSONS XTREME GOLF, LLC**,  
Scottsdale, AZ (US)

**DESCRIPTION**

(\*\*) Term: **15 Years**

(21) Appl. No.: **29/819,273**

(22) Filed: **Dec. 14, 2021**

FIG. 1 is a top perspective view of a golf club head  
according to a first embodiment;  
FIG. 2 is a bottom perspective view of the golf club head of  
FIG. 1;  
FIG. 3 is a front elevational view of the golf club head of  
FIG. 1;  
FIG. 4 is a rear elevational view of the golf club head of FIG.  
1;  
FIG. 5 is a top view of the golf club head of FIG. 1;  
FIG. 6 is a bottom view of the golf club head of FIG. 1;  
FIG. 7 is a left side view of the golf club head of FIG. 1;  
FIG. 8 is a right side view of the golf club head of FIG. 1;  
FIG. 9 is a top perspective view of a golf club head  
according to a second embodiment;  
FIG. 10 is a bottom perspective view of the golf club head  
of FIG. 9;  
FIG. 11 is a front elevational view of the golf club head of  
FIG. 9;  
FIG. 12 is a rear elevational view of the golf club head of  
FIG. 9;  
FIG. 13 is a top view of the golf club head of FIG. 9;  
FIG. 14 is a bottom view of the golf club head of FIG. 9;  
FIG. 15 is a left side view of the golf club head of FIG. 9;  
and,  
FIG. 16 is a right side view of the golf club head of FIG. 9.  
The broken lines shown on the drawings form no part of the  
claimed design.

**Related U.S. Application Data**

(63) Continuation-in-part of application No. 29/800,518,  
filed on Jul. 21, 2021, now Pat. No. Des. 941,946,  
(Continued)

(51) **LOC (13) Cl.** ..... **21-02**

(52) **U.S. Cl.**  
USPC ..... **D21/752**

(58) **Field of Classification Search**  
USPC ..... D21/733, 752, 759  
(Continued)

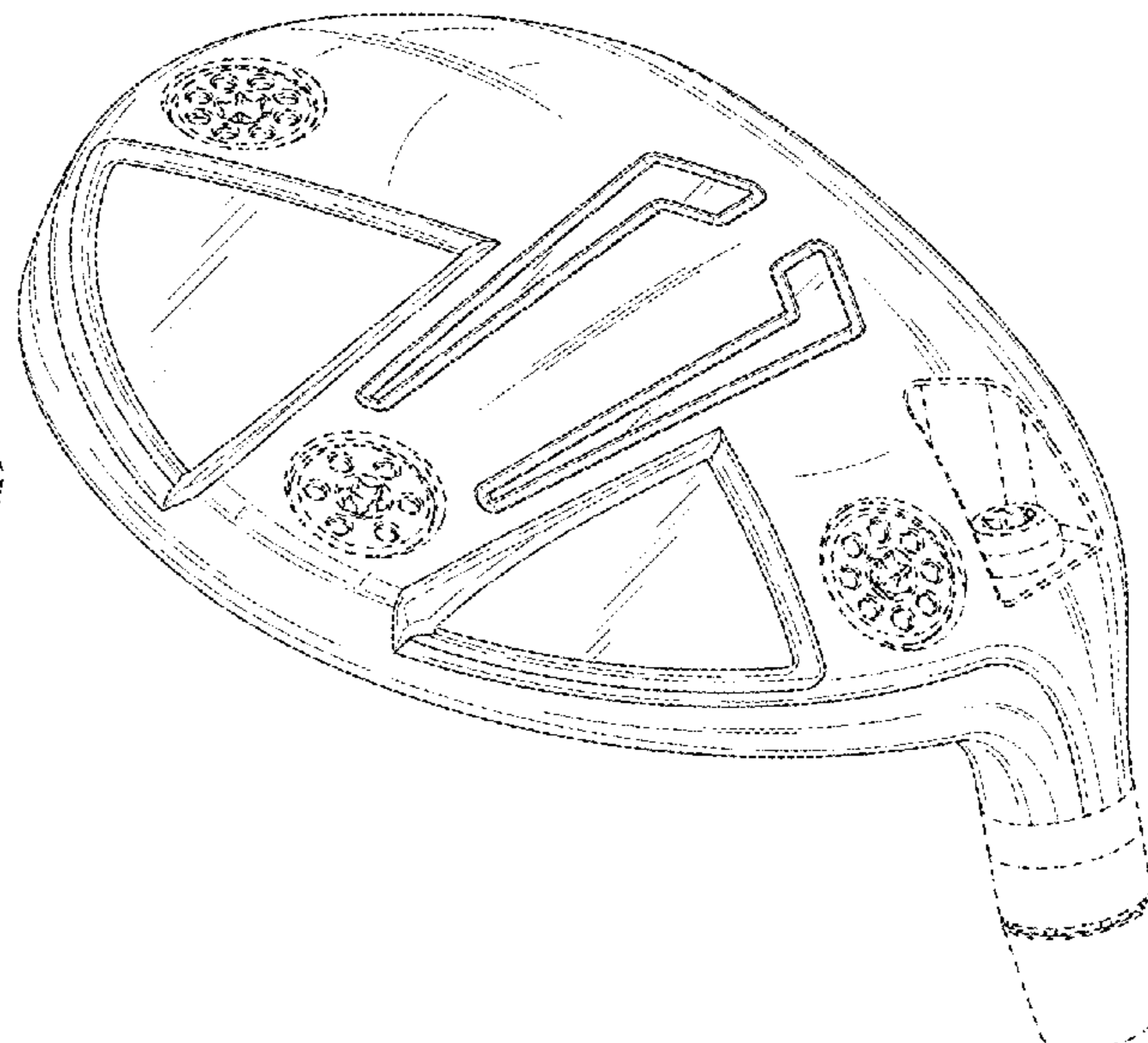
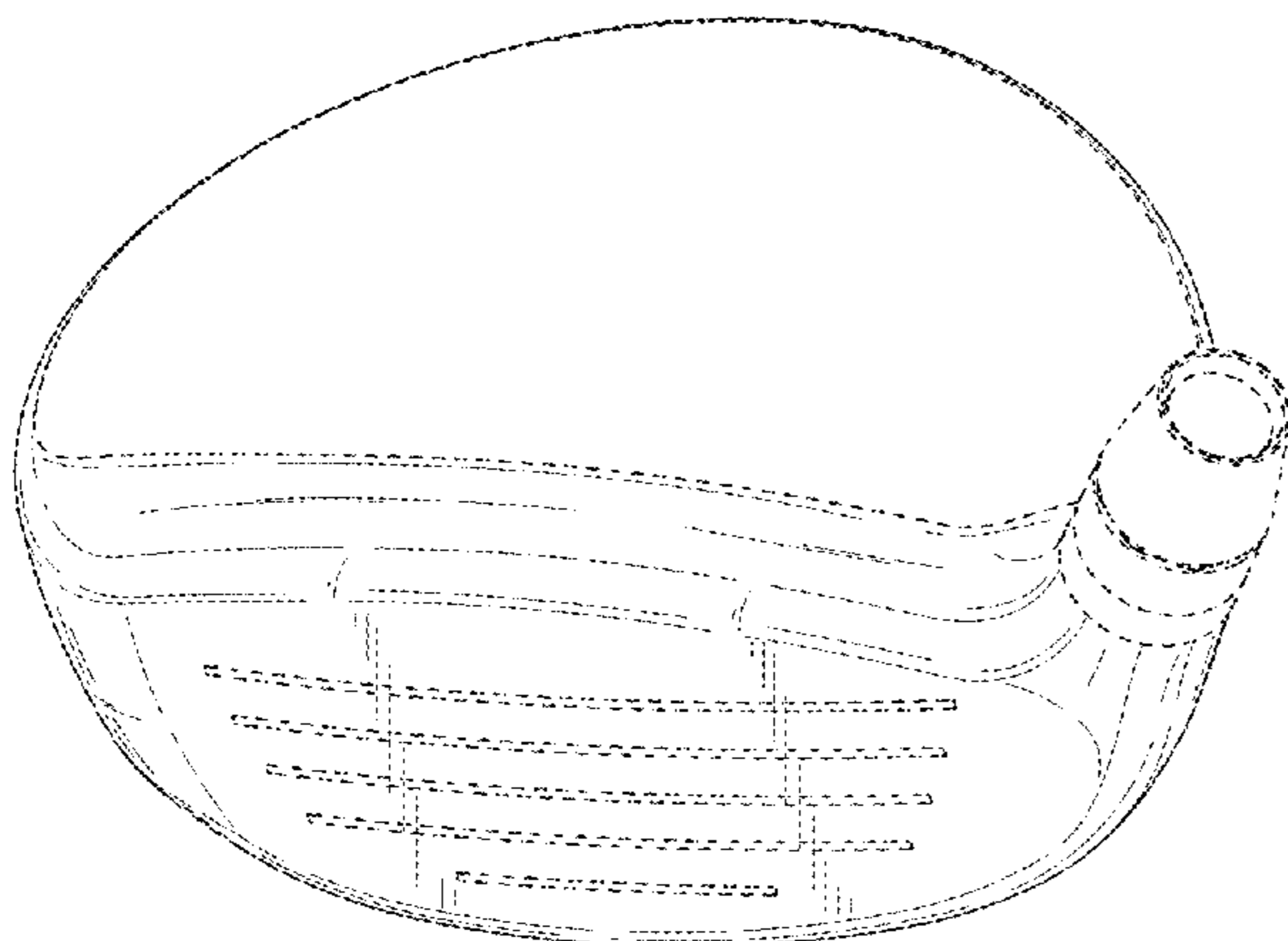
(56) **References Cited**

U.S. PATENT DOCUMENTS

1,133,129 A 3/1915 Govan  
1,269,745 A 6/1918 Robertson

(Continued)

**1 Claim, 8 Drawing Sheets**



**Related U.S. Application Data**

which is a continuation-in-part of application No. 29/754,405, filed on Oct. 9, 2020, which is a continuation-in-part of application No. 29/745,977, filed on Aug. 11, 2020, now abandoned.

- (58) **Field of Classification Search**  
 CPC ..... A63B 53/00; A63B 53/04; A63B 53/0466;  
 A63B 2053/002; A63B 2053/0445; A63B  
 2053/0433; A63B 2053/0491; A63B  
 2053/0437; A63B 60/00; A63B 60/46  
 See application file for complete search history.

(56) **References Cited**

U.S. PATENT DOCUMENTS

1,306,029 A 6/1919 Robertson  
 D55,867 S 7/1920 Matters  
 1,509,429 A 9/1924 Hillerich  
 1,534,600 A 4/1925 Mattern  
 1,538,312 A 5/1925 Neish  
 1,543,691 A 6/1925 Beat  
 1,774,590 A 9/1930 Buhrke  
 D84,525 S 6/1931 Klin  
 D94,549 S 2/1935 Jansky  
 D94,550 S 2/1935 Jansky  
 D138,437 S 8/1944 Link  
 D138,438 S 8/1944 Link  
 D138,439 S 8/1944 Link  
 D138,441 S 8/1944 Link  
 D138,442 S 8/1944 Link  
 D185,177 S 5/1959 Smith  
 3,556,533 A 1/1971 Hollis  
 3,652,094 A 3/1972 Glover  
 D229,431 S 11/1973 Baker  
 D234,609 S 3/1975 Raymont  
 D234,610 S 3/1975 Raymont  
 D240,748 S 7/1976 Bock et al.  
 D241,956 S 10/1976 Timbrook  
 4,085,934 A 4/1978 Churchward  
 D253,778 S 12/1979 Madison  
 4,332,388 A 6/1982 Crow  
 D285,954 S 9/1986 Hasegawa  
 4,824,116 A 4/1989 Nagamoto et al.  
 D307,783 S 5/1990 Iinuma  
 D310,254 S 8/1990 Take et al.  
 4,988,104 A 1/1991 Shiotani et al.  
 D326,885 S 6/1992 Paul  
 5,158,296 A 10/1992 Lee  
 5,213,328 A 5/1993 Long  
 5,213,329 A 5/1993 Okumoto et al.  
 D338,935 S 8/1993 Antonious  
 D344,561 S 2/1994 Gorman  
 D351,883 S 10/1994 Solheim et al.  
 5,451,056 A 9/1995 Manning  
 5,518,243 A 5/1996 Redman  
 D371,816 S 7/1996 Yoshioka  
 D378,111 S \* 2/1997 Parente ..... D21/752  
 5,637,045 A 6/1997 Igarashi  
 D384,120 S \* 9/1997 De La Cruz ..... D21/752  
 5,766,091 A 6/1998 Humphrey et al.  
 5,788,584 A 8/1998 Parente et al.  
 D400,625 S 11/1998 Kubica et al.  
 D400,627 S 11/1998 Kubica et al.  
 D401,989 S \* 12/1998 Sheets ..... D21/733  
 D402,339 S \* 12/1998 Sheets ..... D21/733  
 D402,340 S \* 12/1998 Sheets ..... D21/733  
 D402,726 S \* 12/1998 McCabe ..... D21/753  
 D405,489 S 2/1999 Kubica et al.  
 D405,492 S 2/1999 Kubica et al.  
 D433,073 S \* 10/2000 Sodano ..... D21/752  
 D442,244 S 5/2001 Olsavsky et al.  
 D444,830 S 7/2001 Kubica et al.  
 D448,824 S 10/2001 Koizumi et al.  
 6,306,048 B1 10/2001 McCabe et al.  
 D460,989 S 7/2002 Ehlers

D469,141 S \* 1/2003 Poynor ..... D21/759  
 D473,276 S 4/2003 Kenmi  
 D473,604 S 4/2003 Antonious  
 D478,140 S 8/2003 Burrows  
 D481,087 S 10/2003 Antonious  
 6,638,182 B2 10/2003 Kosmatka  
 D491,992 S 6/2004 Baiocchi  
 6,773,360 B2 8/2004 Willett et al.  
 D499,158 S 11/2004 Imamoto  
 D502,520 S 3/2005 Dogan et al.  
 D505,701 S 5/2005 Dogan et al.  
 D507,615 S 7/2005 Imamoto  
 D508,969 S 8/2005 Hasebe  
 6,939,247 B1 9/2005 Schweigert et al.  
 D513,051 S 12/2005 Barez et al.  
 D514,179 S 1/2006 Chen et al.  
 D514,185 S 1/2006 Barez et al.  
 D515,157 S 2/2006 Madore  
 D515,642 S 2/2006 Antonious  
 D518,129 S \* 3/2006 Poynor ..... D21/759  
 D520,585 S 5/2006 Hasebe  
 D520,586 S 5/2006 Bingman  
 D521,093 S \* 5/2006 Jorgensen ..... D21/759  
 D522,077 S 5/2006 Schweigert et al.  
 D522,601 S 6/2006 Schweigert et al.  
 D523,103 S 6/2006 Hocknell et al.  
 D523,104 S 6/2006 Hasebe  
 D523,498 S 6/2006 Chen et al.  
 D523,502 S \* 6/2006 Jorgensen ..... D21/752  
 D524,392 S 7/2006 Madore et al.  
 D524,396 S 7/2006 Madore et al.  
 D524,397 S 7/2006 Madore et al.  
 D526,694 S 8/2006 Schweigert et al.  
 D532,471 S 11/2006 Oldknow  
 D532,854 S 11/2006 Oldknow  
 D533,611 S 12/2006 Mahaffey et al.  
 D534,229 S \* 12/2006 Barez ..... D21/752  
 D534,599 S 1/2007 Barez et al.  
 7,166,040 B2 1/2007 Hoffman et al.  
 D536,401 S 2/2007 Kawami  
 D536,402 S 2/2007 Kawami  
 D536,403 S 2/2007 Kawami  
 D537,495 S 2/2007 Schweigert et al.  
 D538,363 S 3/2007 Schweigert et al.  
 D538,371 S 3/2007 Kawami  
 7,186,190 B1 3/2007 Beach et al.  
 D541,364 S \* 4/2007 Barez ..... D21/759  
 7,223,180 B2 5/2007 Willett et al.  
 D544,561 S 6/2007 Oldknow  
 D550,318 S \* 9/2007 Oldknow ..... D21/759  
 D550,800 S 9/2007 Ruggiero et al.  
 D552,198 S 10/2007 Schweigert et al.  
 D554,719 S \* 11/2007 Barez ..... D21/752  
 D554,720 S \* 11/2007 Barez ..... D21/752  
 D556,280 S 11/2007 Madore  
 D557,363 S 12/2007 Jertson et al.  
 D558,287 S 12/2007 Jertson et al.  
 D558,288 S 12/2007 Jertson et al.  
 D560,262 S 1/2008 Nguyen et al.  
 D561,284 S 2/2008 Nagai et al.  
 D561,856 S \* 2/2008 Barez ..... D21/752  
 D562,421 S 2/2008 Jertson et al.  
 D563,498 S 3/2008 Jertson et al.  
 D564,054 S 3/2008 Jertson et al.  
 D564,055 S 3/2008 Jertson et al.  
 7,338,388 B2 3/2008 Schweigert et al.  
 D567,317 S 4/2008 Jertson et al.  
 D569,933 S 5/2008 Jertson et al.  
 D569,934 S 5/2008 Jertson et al.  
 D569,935 S 5/2008 Schweigert et al.  
 D569,936 S 5/2008 Schweigert et al.  
 D569,942 S 5/2008 Jertson et al.  
 D570,937 S 6/2008 Schweigert et al.  
 D570,938 S 6/2008 Jertson et al.  
 7,407,447 B2 8/2008 Beach et al.  
 7,410,425 B2 8/2008 Willett et al.  
 7,410,426 B2 8/2008 Willett et al.  
 7,419,441 B2 9/2008 Hoffman et al.  
 D579,507 S 10/2008 Llewellyn et al.

(56)

References Cited

U.S. PATENT DOCUMENTS

7,448,963 B2	11/2008	Beach et al.	D726,854 S *	4/2015	Song .....	D21/759
7,448,964 B2	11/2008	Schweigert et al.	D729,892 S	5/2015	Nicolette et al.	
D584,782 S	1/2009	Barez et al.	D733,234 S	6/2015	Nicolette	
D584,783 S	1/2009	Barez et al.	D737,388 S	8/2015	Tang et al.	
D584,784 S	1/2009	Barez et al.	9,199,140 B1	12/2015	Schweigert et al.	
7,530,904 B2	5/2009	Beach et al.	D746,927 S	1/2016	Parsons et al.	
D594,520 S	6/2009	Schweigert et al.	D748,215 S	1/2016	Parsons et al.	
D594,521 S	6/2009	Jertson et al.	D753,251 S	4/2016	Schweigert et al.	
D594,919 S	6/2009	Schweigert et al.	D755,319 S	5/2016	Nicolette et al.	
7,540,811 B2	6/2009	Beach et al.	9,352,197 B2	5/2016	Parsons et al.	
D597,620 S	8/2009	Taylor et al.	D759,178 S	6/2016	Nicolette	
7,568,985 B2	8/2009	Beach et al.	D760,334 S	6/2016	Schweigert et al.	
7,578,753 B2	8/2009	Beach et al.	9,399,158 B2	7/2016	Parsons et al.	
D600,297 S	9/2009	Jertson et al.	D764,614 S	8/2016	Parsons et al.	
7,591,738 B2	9/2009	Beach et al.	D765,808 S	9/2016	Cardani et al.	
D603,472 S	11/2009	Schweigert et al.	D766,391 S	9/2016	Cardani et al.	
7,611,424 B2	11/2009	Nagai et al.	D767,696 S	9/2016	Parsons et al.	
7,621,823 B2	11/2009	Beach et al.	D771,209 S *	11/2016	Chen .....	D21/752
D605,715 S	12/2009	Barez et al.	D776,216 S	1/2017	Schweigert et al.	
7,632,194 B2	12/2009	Beach et al.	D777,273 S *	1/2017	Stokke .....	D21/759
7,658,686 B2	2/2010	Soracco	D777,274 S *	1/2017	Stokke .....	D21/759
7,713,142 B2	5/2010	Hoffman et al.	D777,856 S *	1/2017	Jertson .....	D21/752
7,717,804 B2	5/2010	Beach et al.	D777,858 S *	1/2017	Schweigert .....	D21/752
7,717,805 B2	5/2010	Beach et al.	9,555,295 B2	1/2017	Schweigert et al.	
D618,746 S	6/2010	Jertson et al.	D783,104 S *	4/2017	Oliveiro .....	D21/752
D618,747 S	6/2010	Schweigert et al.	9,630,070 B2	4/2017	Parsons et al.	
D618,748 S *	6/2010	Oldknow .....	D786,377 S	5/2017	Parsons et al.	
D618,751 S	6/2010	Breier et al.	D791,257 S	7/2017	Oldknow et al.	
D618,753 S	6/2010	Jertson et al.	D795,978 S	8/2017	Parsons et al.	
D618,754 S	6/2010	Schweigert et al.	D802,069 S *	11/2017	Parsons .....	D21/752
7,744,484 B1	6/2010	Chao	D802,070 S	11/2017	Parsons et al.	
D619,182 S	7/2010	Foster et al.	D807,976 S	1/2018	Parsons et al.	
7,798,203 B2	9/2010	Schweigert et al.	D811,503 S	2/2018	Bacon et al.	
7,846,041 B2	12/2010	Beach et al.	D812,703 S	3/2018	Tang	
D631,111 S	1/2011	Bennett et al.	D813,327 S *	3/2018	Kim .....	D21/752
D635,626 S	4/2011	Nicolette	D813,329 S	3/2018	Tang et al.	
7,927,229 B2	4/2011	Jertson et al.	D814,582 S	4/2018	Bacon et al.	
D638,893 S	5/2011	Schweigert et al.	D814,583 S	4/2018	Stokke et al.	
D638,896 S	5/2011	Schweigert et al.	D814,584 S	4/2018	Tang et al.	
7,963,861 B2	6/2011	Beach et al.	D815,223 S	4/2018	Stokke et al.	
8,012,038 B1	9/2011	Beach et al.	D821,514 S	6/2018	Sillies	
D647,585 S	10/2011	Jertson et al.	D822,134 S	7/2018	Parsons et al.	
D652,464 S	1/2012	Bertone et al.	D823,410 S	7/2018	Parsons et al.	
D656,211 S	3/2012	Foster	D823,958 S *	7/2018	Stokke .....	D21/752
D661,751 S	6/2012	Nicolette et al.	D825,013 S	8/2018	Milleman et al.	
D661,756 S	6/2012	Nicolette et al.	D827,067 S	8/2018	Becktor et al.	
8,257,196 B1	9/2012	Abbott et al.	D827,745 S	9/2018	Schweigert et al.	
8,262,506 B2 *	9/2012	Watson .....	D839,372 S *	1/2019	Schweigert .....	D21/752
		A63B 53/0466	D850,551 S	6/2019	Parsons et al.	
		473/334	D852,303 S	6/2019	Parsons et al.	
D673,630 S	1/2013	Schweigert	D852,304 S	6/2019	Parsons et al.	
D673,632 S	1/2013	Schweigert et al.	D852,305 S	6/2019	Parsons et al.	
8,371,957 B2	2/2013	Schweigert et al.	10,376,754 B2	8/2019	Parsons et al.	
D680,179 S	4/2013	Solheim et al.	D861,811 S *	10/2019	Jertson .....	D21/752
D681,142 S	4/2013	Fossum et al.	D865,886 S	11/2019	Parsons et al.	
8,414,422 B2	4/2013	Peralta et al.	D875,862 S *	2/2020	Foster .....	D21/759
8,485,919 B2 *	7/2013	Rice .....	10,556,161 B2	2/2020	Jertson et al.	
		A63B 60/02	D880,632 S *	4/2020	Foster .....	D21/759
		473/334	10,695,624 B2	6/2020	Parsons et al.	
D689,156 S	9/2013	Stokke et al.	10,722,765 B2	7/2020	Schweigert et al.	
D691,230 S	10/2013	Chen et al.	D897,462 S	9/2020	Parsons et al.	
8,562,457 B2	10/2013	Beach et al.	D897,463 S	9/2020	Parsons et al.	
8,608,587 B2	12/2013	Henrikson et al.	D897,464 S	9/2020	Parsons et al.	
8,628,431 B2	1/2014	Schweigert et al.	D909,511 S	2/2021	Cyrulik et al.	
8,663,026 B2	3/2014	Blowers et al.	D909,517 S	2/2021	Cyrulik	
8,777,778 B2	7/2014	Solheim et al.	D914,817 S	3/2021	Parsons et al.	
8,784,232 B2	7/2014	Jertson et al.	D914,820 S	3/2021	Parsons et al.	
8,790,196 B2	7/2014	Solheim et al.	D920,454 S *	5/2021	Chun .....	D21/752
D712,989 S	9/2014	Gillig	D920,455 S *	5/2021	Chun .....	D21/752
D714,894 S *	10/2014	Tang .....	D920,456 S *	5/2021	Song .....	D21/752
8,858,362 B1 *	10/2014	Leposky .....	D921,786 S *	6/2021	Parsons .....	D21/752
		A63B 53/0466	D921,787 S *	6/2021	Parsons .....	D21/752
		473/334	D923,732 S *	6/2021	Parsons .....	D21/752
D722,351 S	2/2015	Parsons et al.	D925,674 S *	7/2021	Song .....	D21/752
D724,164 S	3/2015	Schweigert et al.	D926,901 S *	8/2021	Parsons .....	D21/752
8,979,671 B1 *	3/2015	DeMille .....	D930,098 S *	9/2021	Kitching, Jr. ....	D21/752
		A63B 60/00	D930,100 S	9/2021	Parsons et al.	
		473/334	D930,773 S	9/2021	Parsons et al.	
D726,848 S *	4/2015	Song .....	D930,774 S	9/2021	Nicolette et al.	
		D21/752				

(56)

**References Cited**

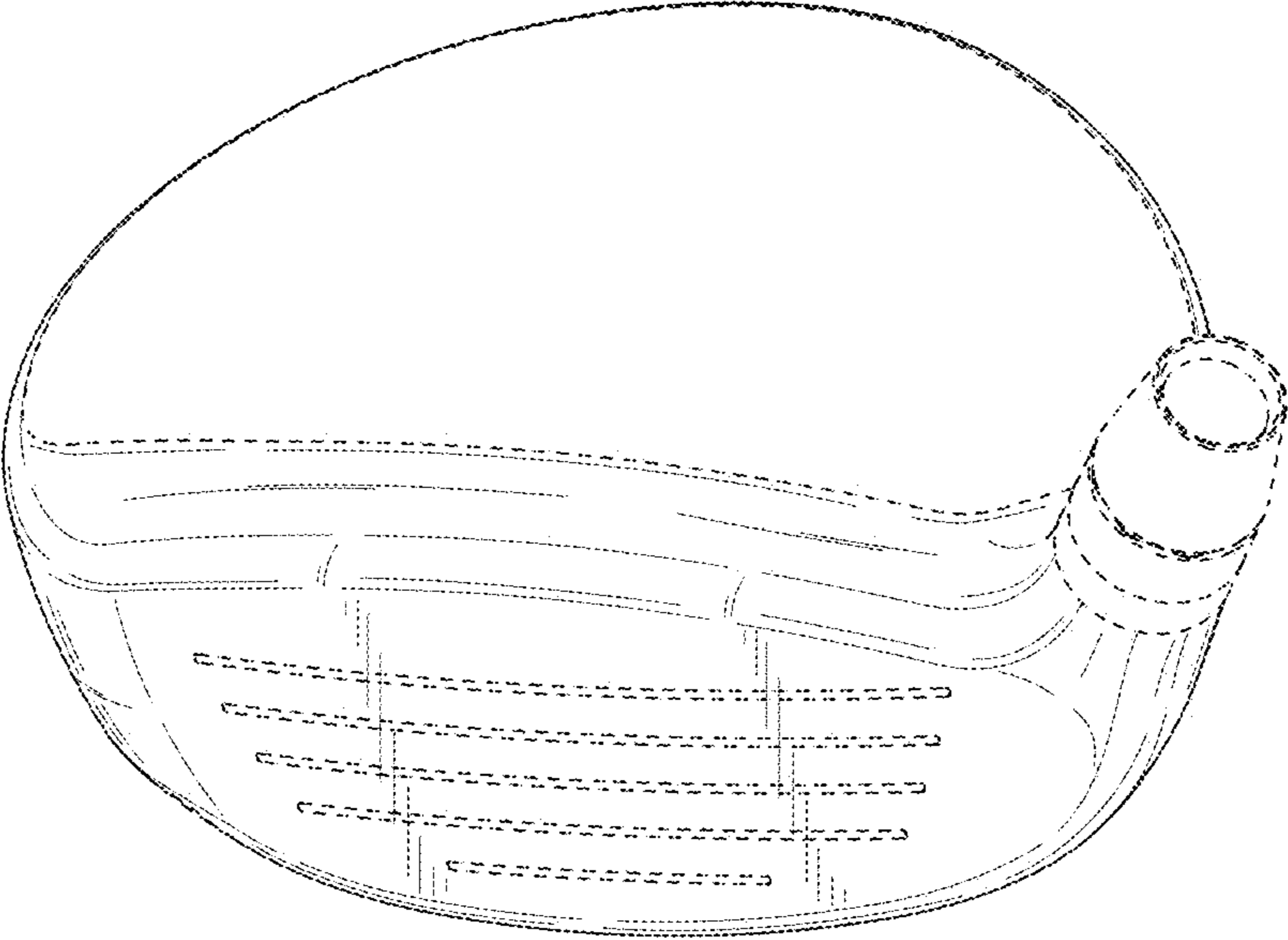
U.S. PATENT DOCUMENTS

D930,775	S	9/2021	Nicolette et al.	
D941,946	S *	1/2022	Parsons .....	D21/752
2006/0105856	A1	5/2006	Lo	
2006/0111200	A1	5/2006	Poynor	
2007/0293344	A1	12/2007	Davis	
2008/0188322	A1	8/2008	Anderson et al.	
2009/0029795	A1	1/2009	Schweigert et al.	
2010/0144461	A1	6/2010	Ban	
2011/0143858	A1	6/2011	Peralta et al.	
2012/0202615	A1 *	8/2012	Beach .....	A63B 60/52 473/338
2013/0303304	A1	11/2013	Sato	
2014/0113739	A1	4/2014	Jertson et al.	
2019/0314690	A1	10/2019	Schweigert et al.	
2020/0215397	A1	7/2020	Parsons et al.	
2020/0230471	A1	7/2020	Parsons et al.	

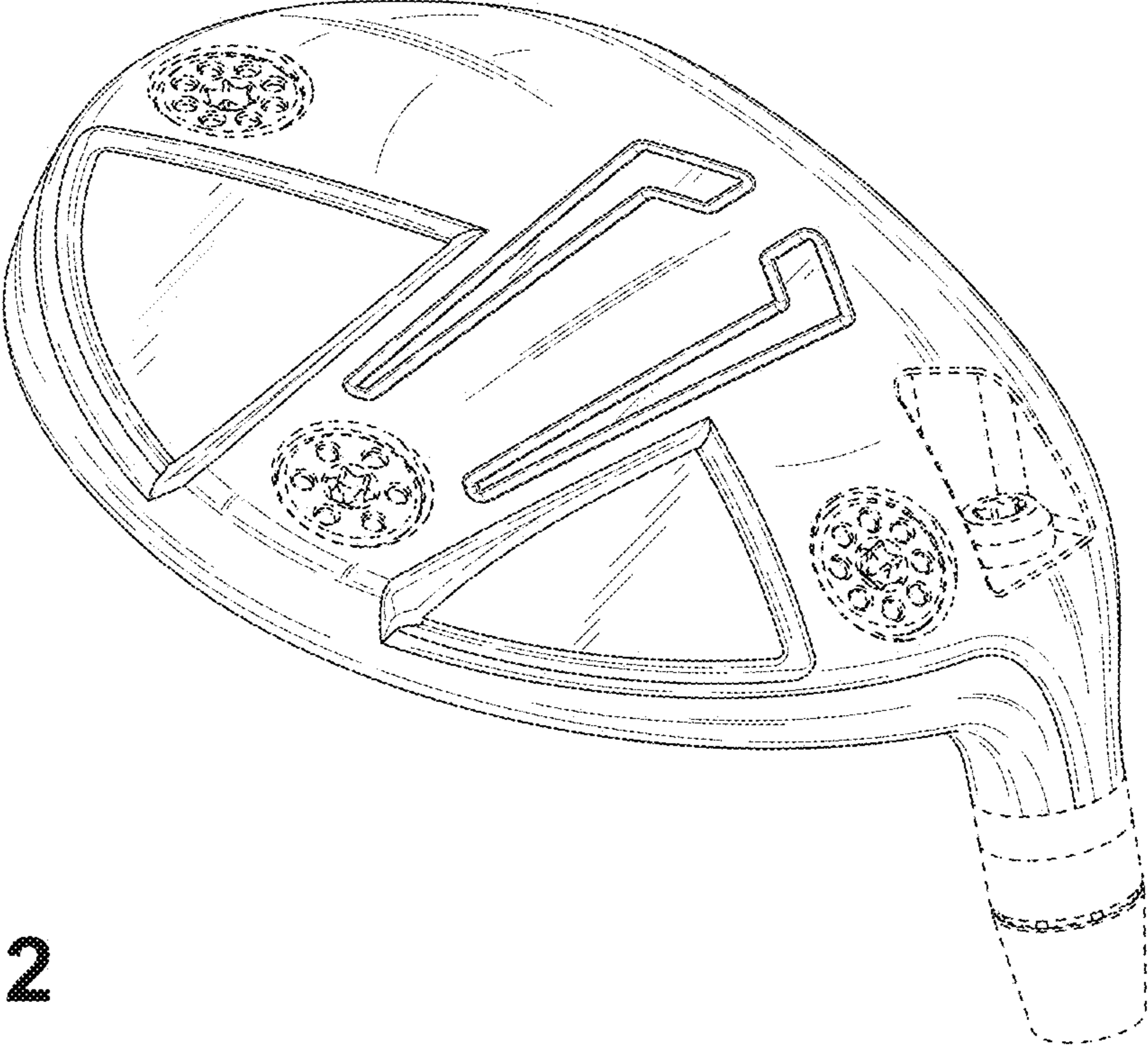
FOREIGN PATENT DOCUMENTS

CN	203108126	U	8/2013
CN	102143783	B	2/2014
CN	203790537	U	8/2014
EP	1955740	A1	8/2008
JP	H10241003	A	9/1998
JP	H119742	A	1/1999
JP	2002535056	A	10/2002
JP	2005287679	A	10/2005
JP	2006223331	A	8/2006
JP	2007136068	A	6/2007
JP	20080173314		7/2008
JP	3158662	U	4/2010
JP	2013544178	A	12/2013

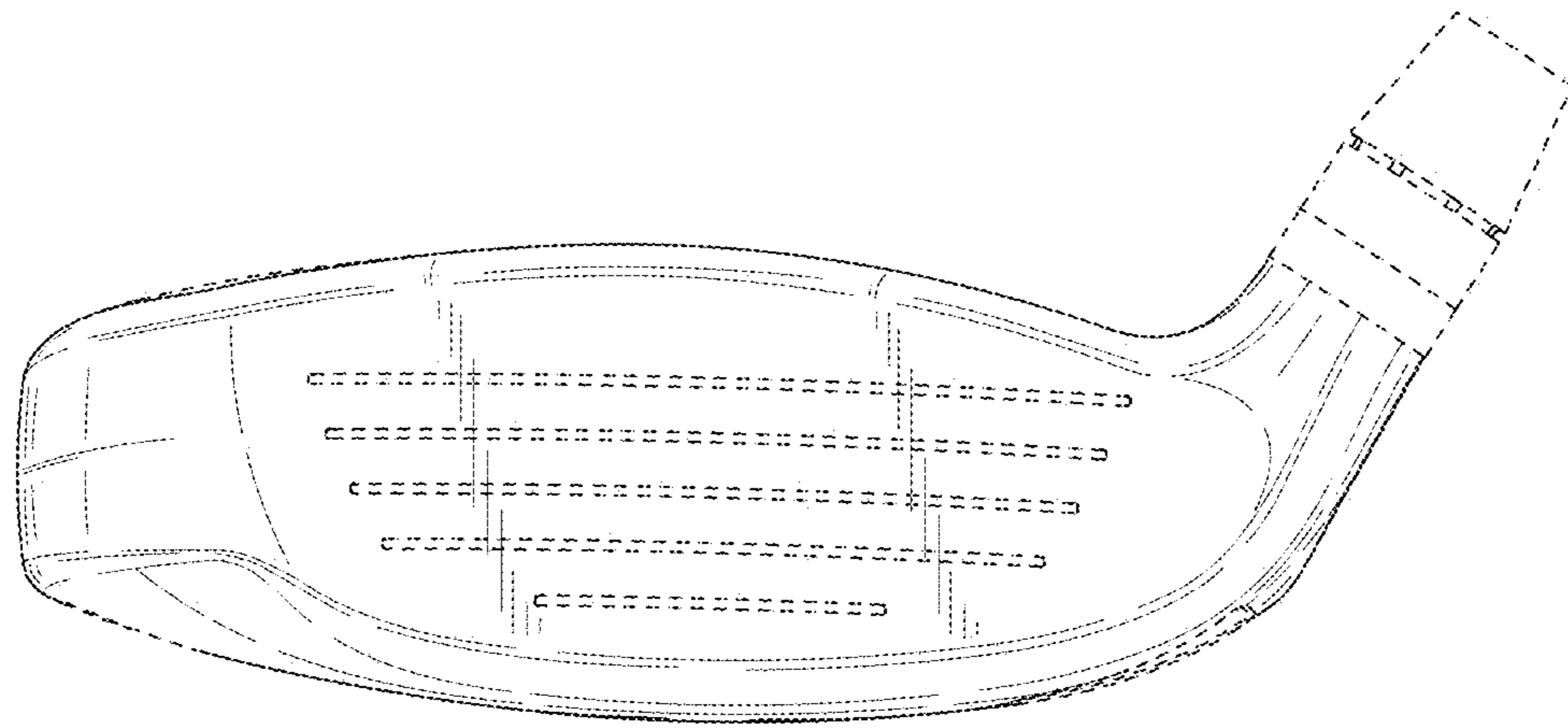
\* cited by examiner



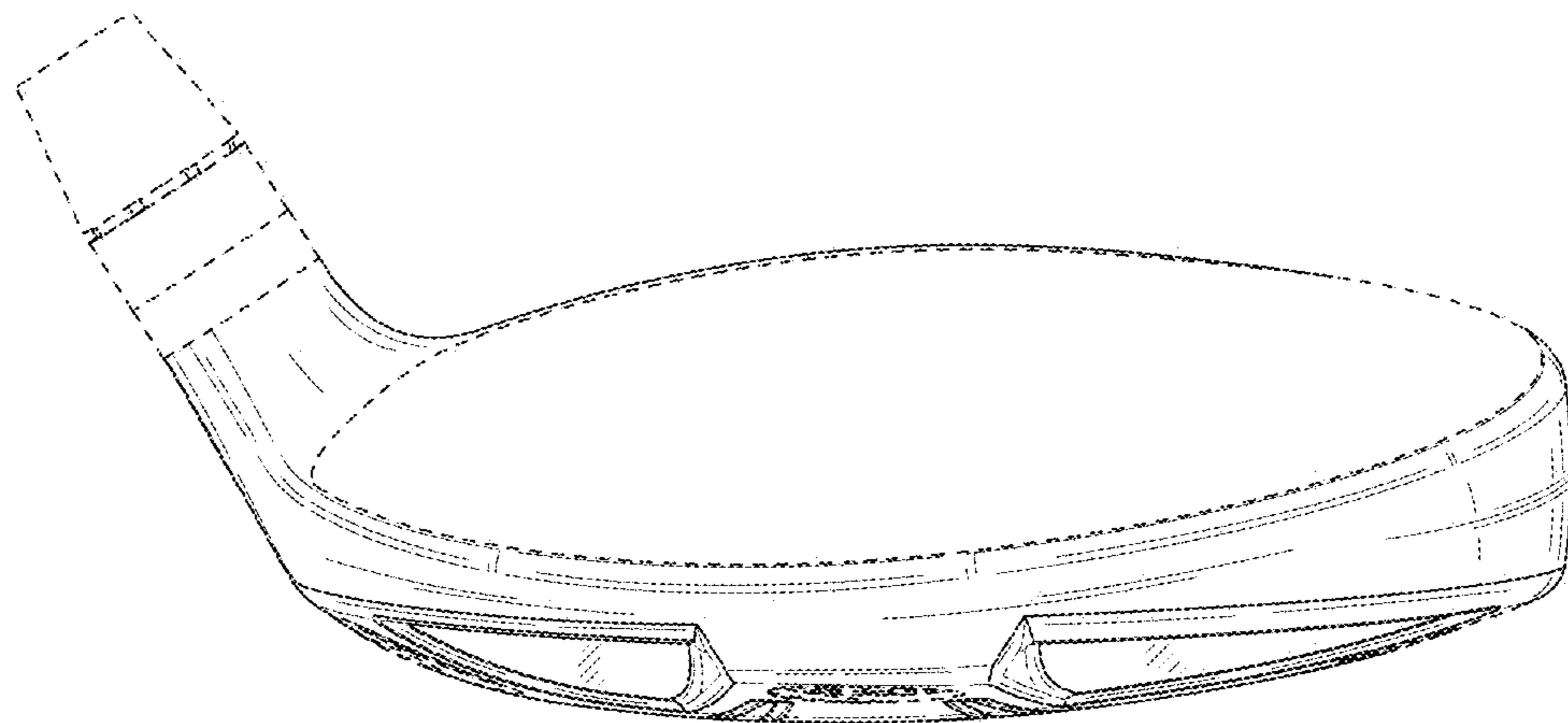
**FIG. 1**



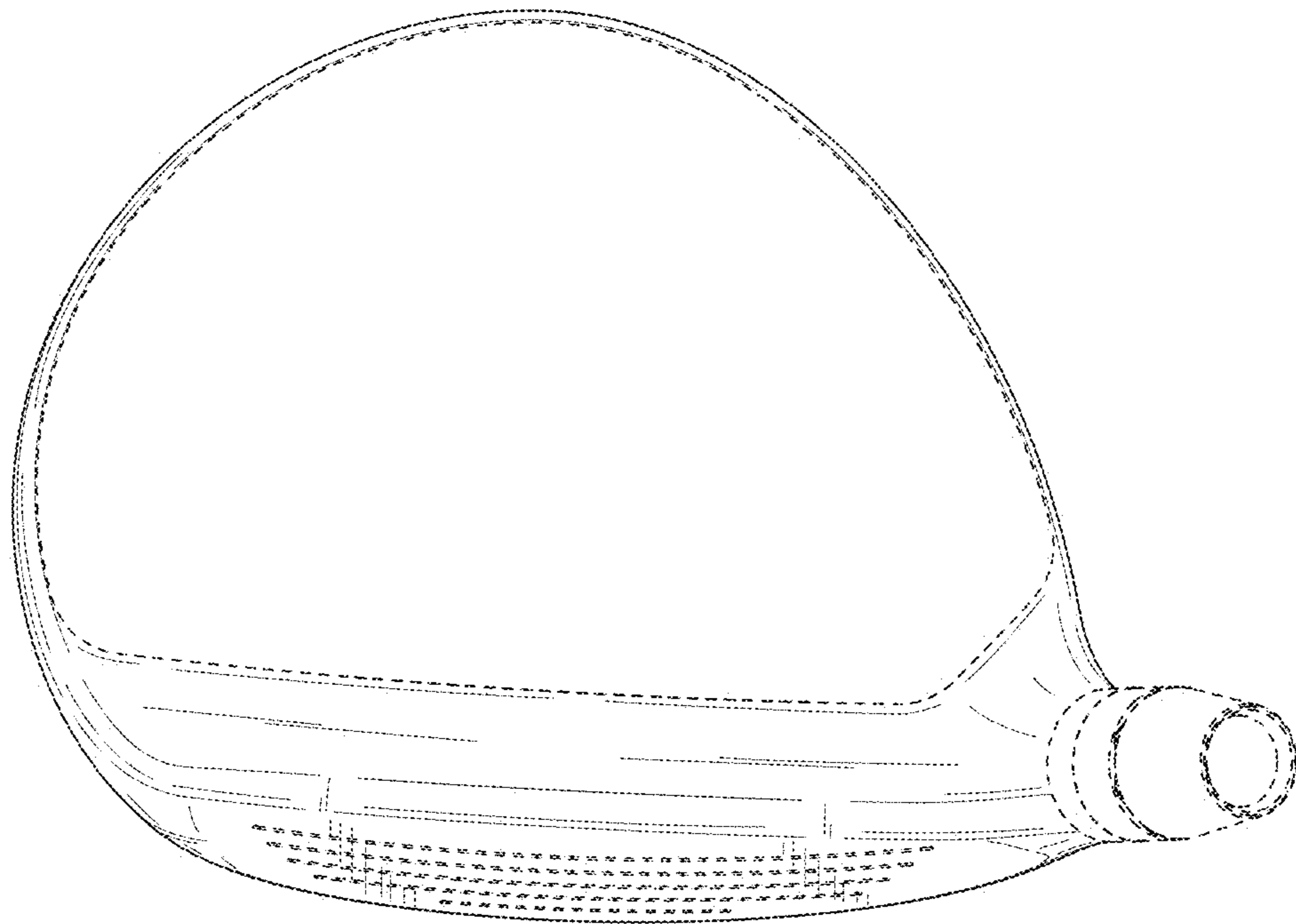
**FIG. 2**



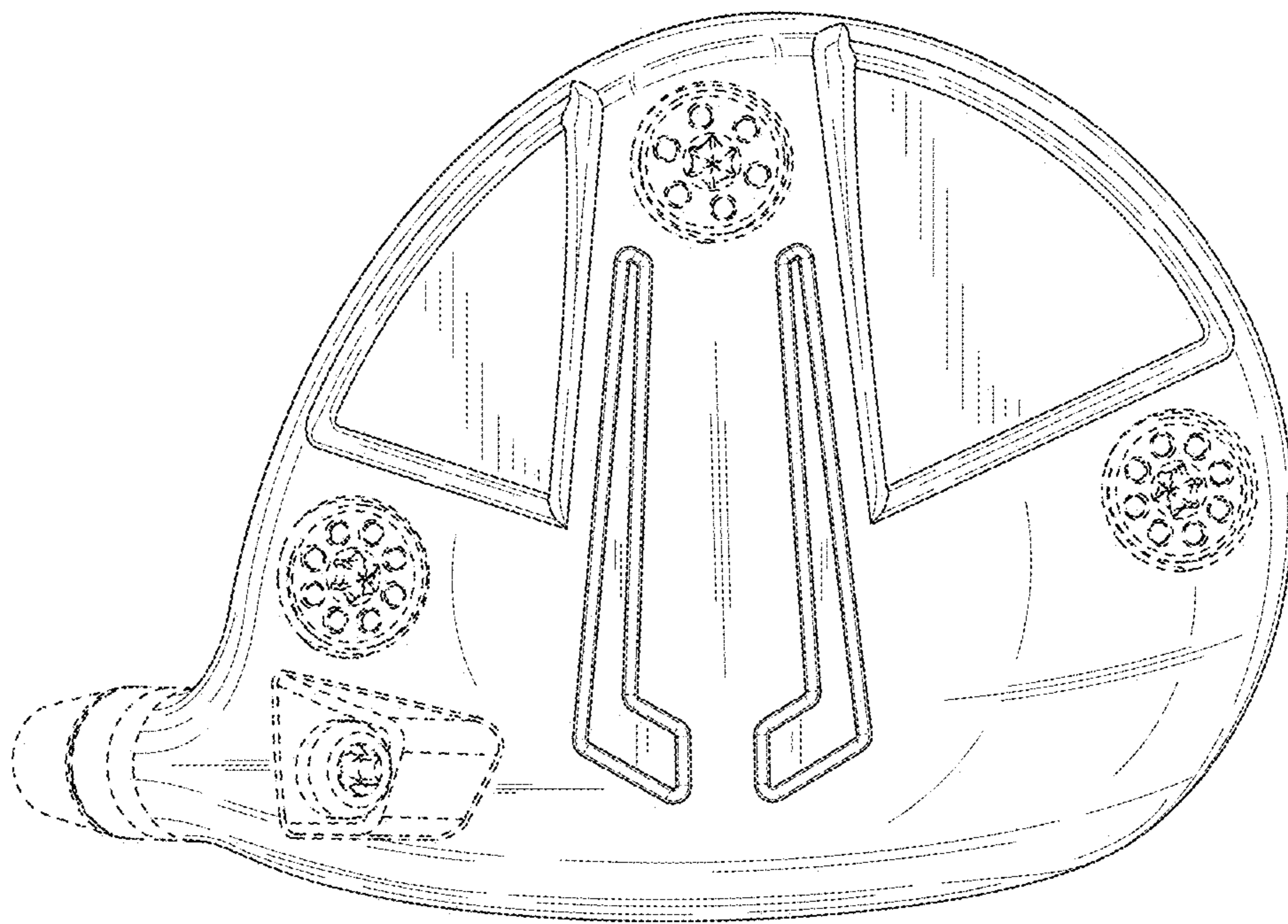
**FIG. 3**



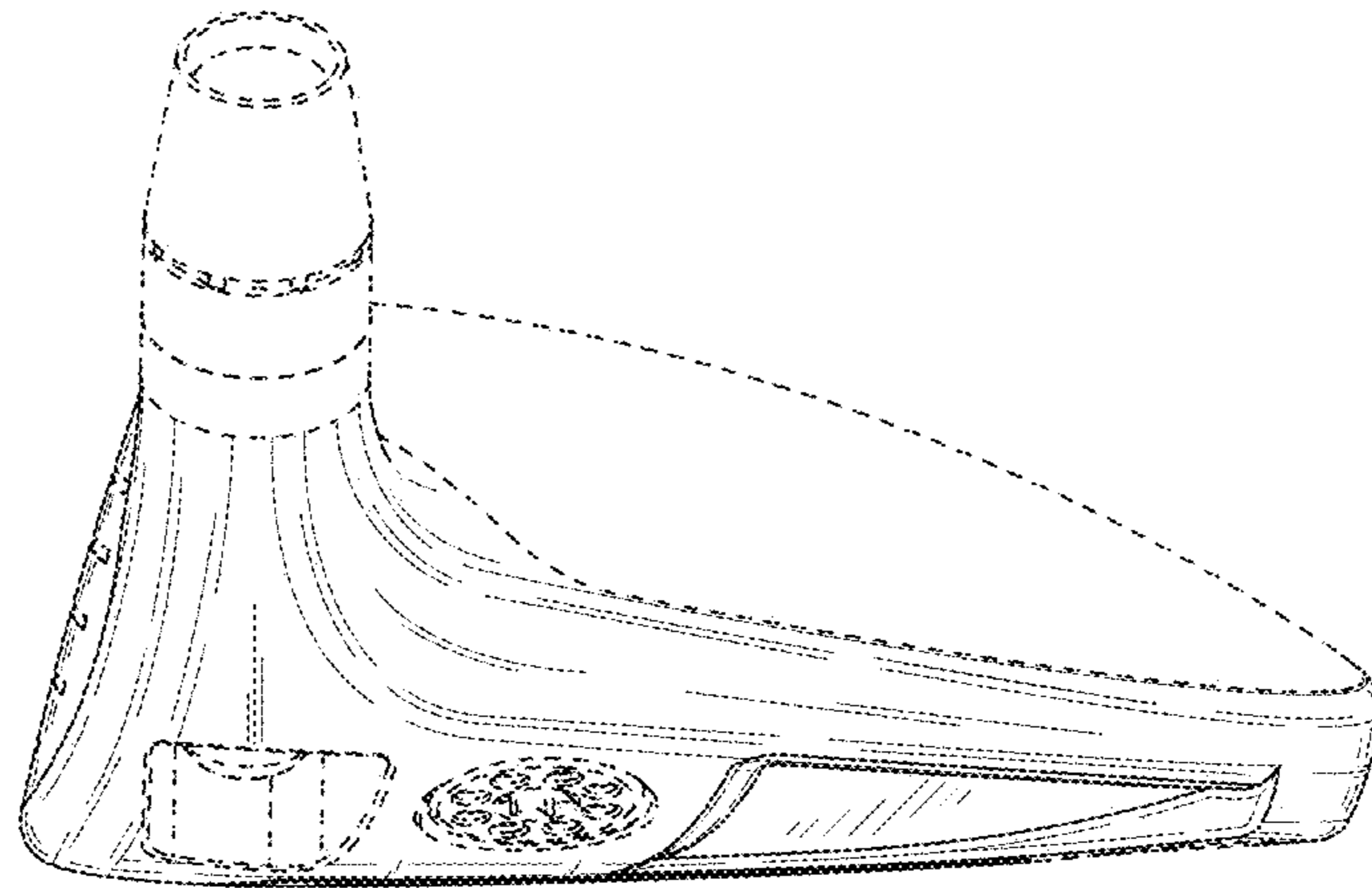
**FIG. 4**



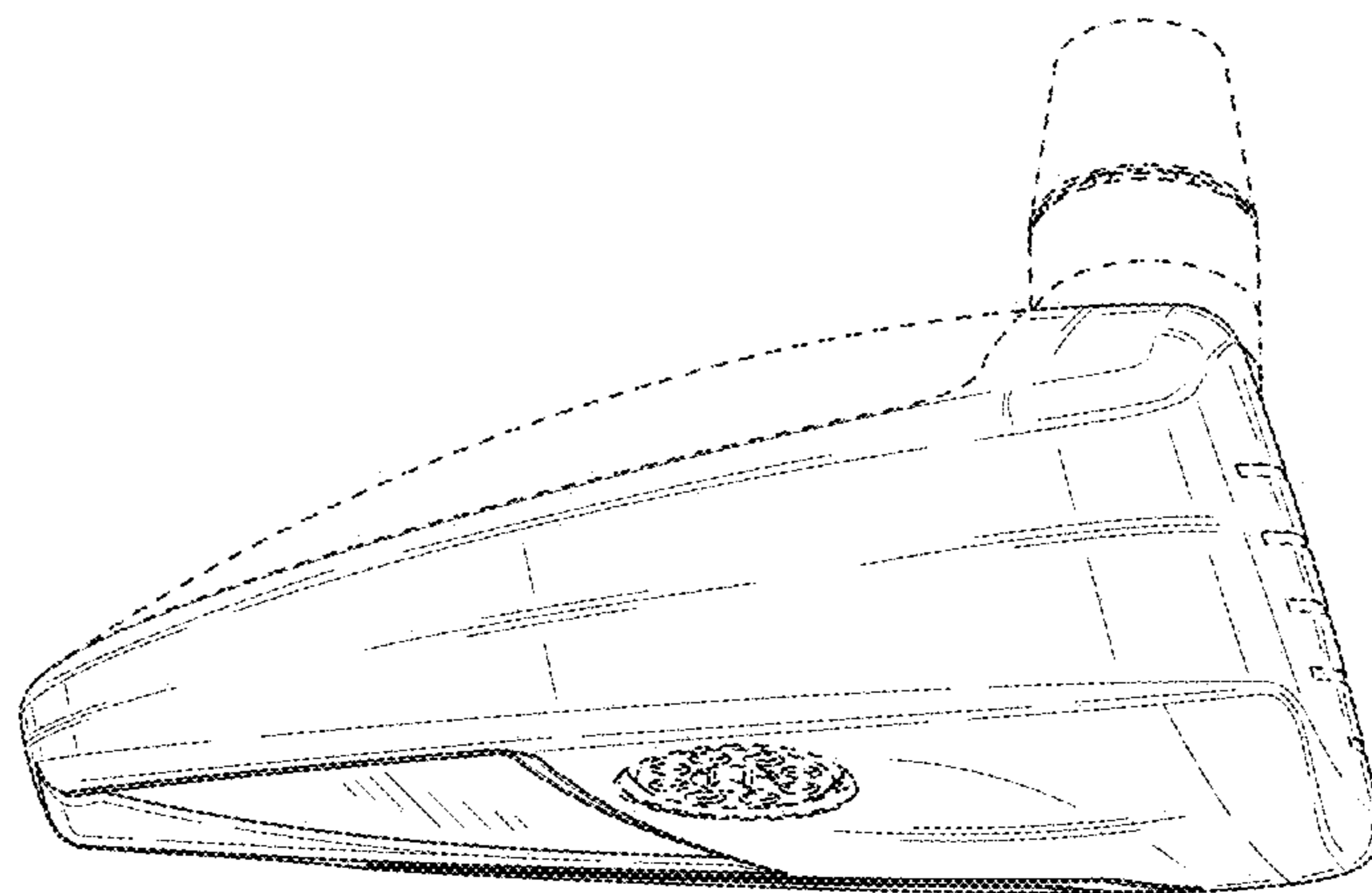
**FIG. 5**



**FIG. 6**

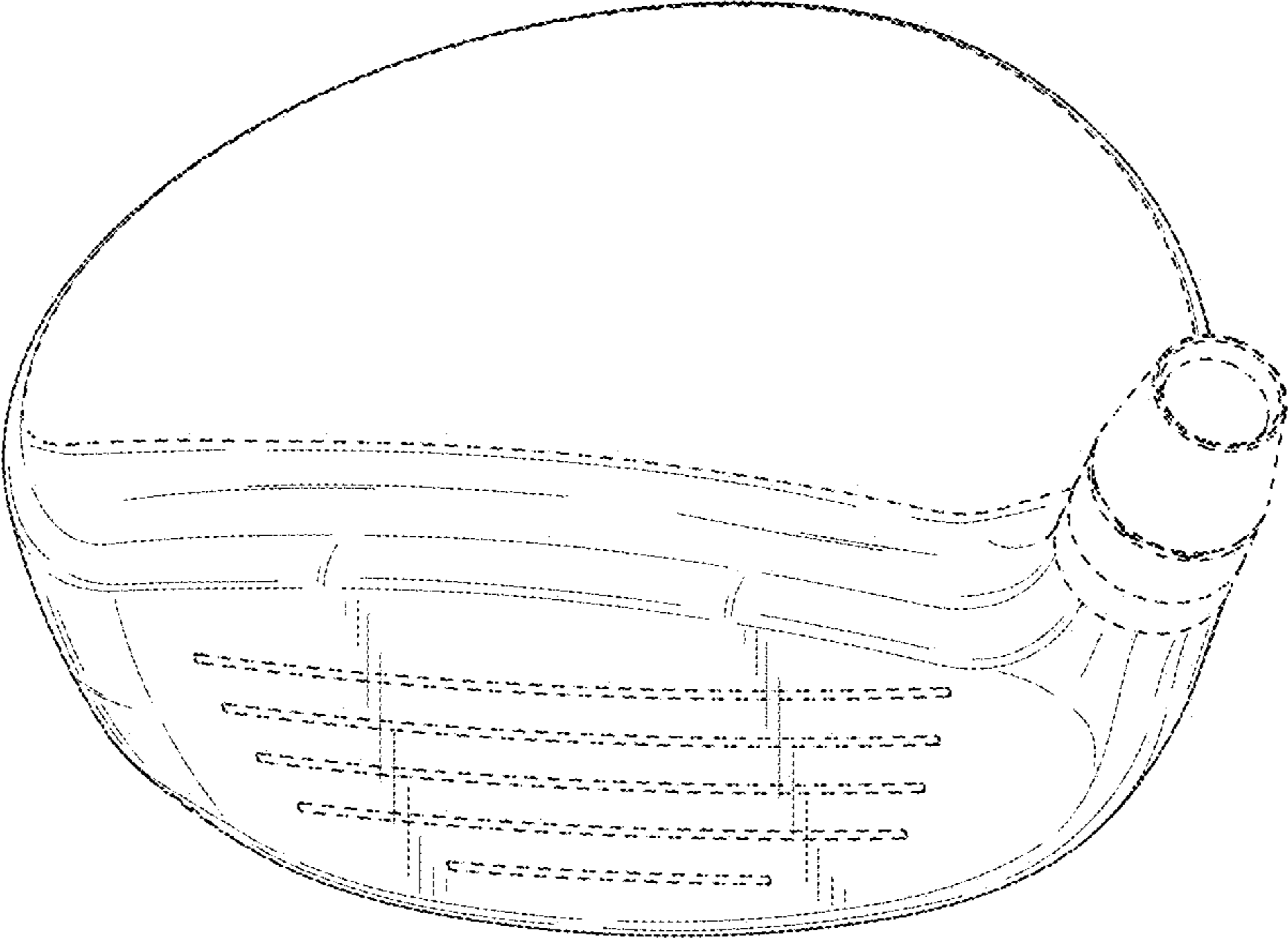


**FIG. 7**

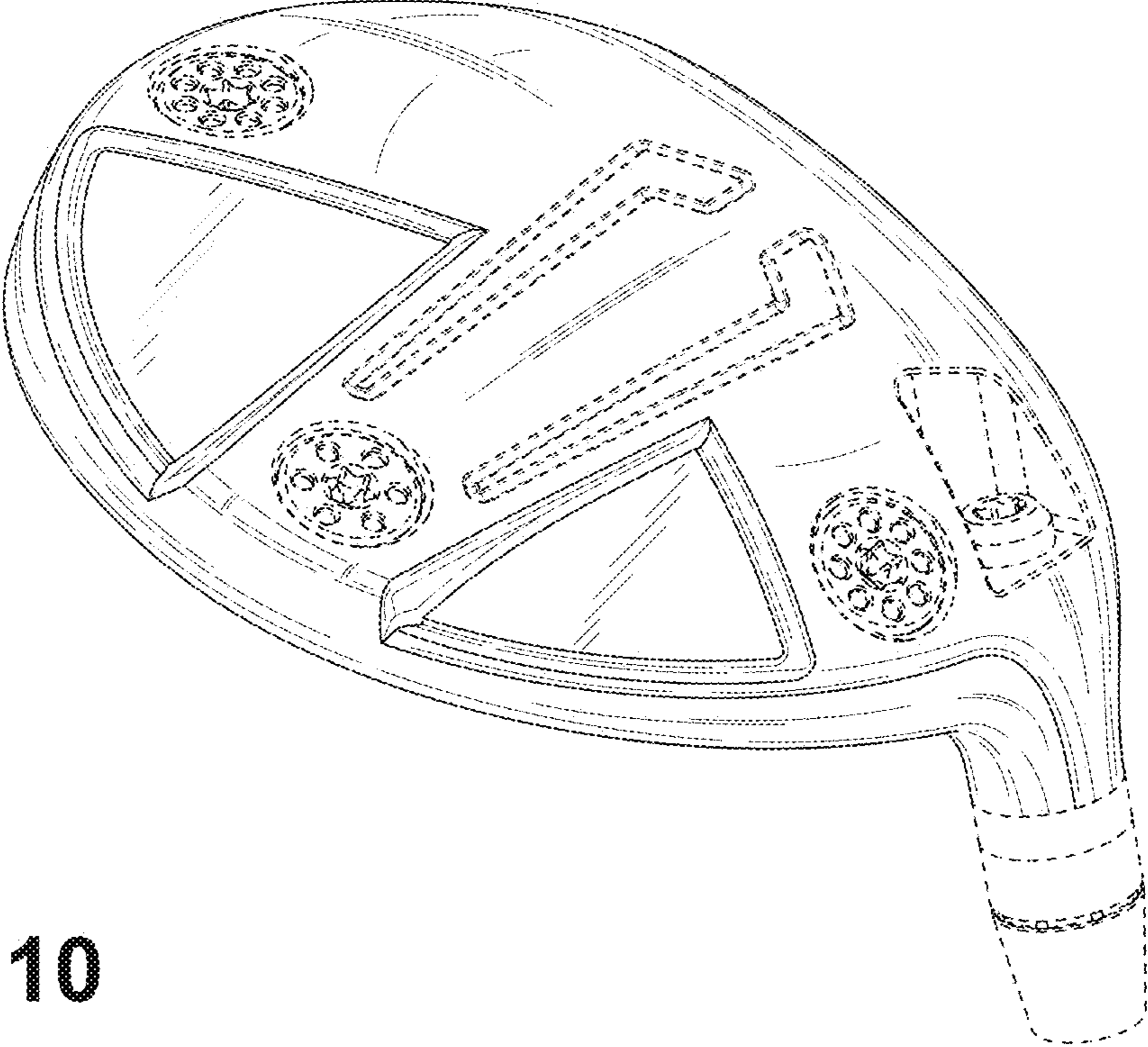


**FIG. 8**

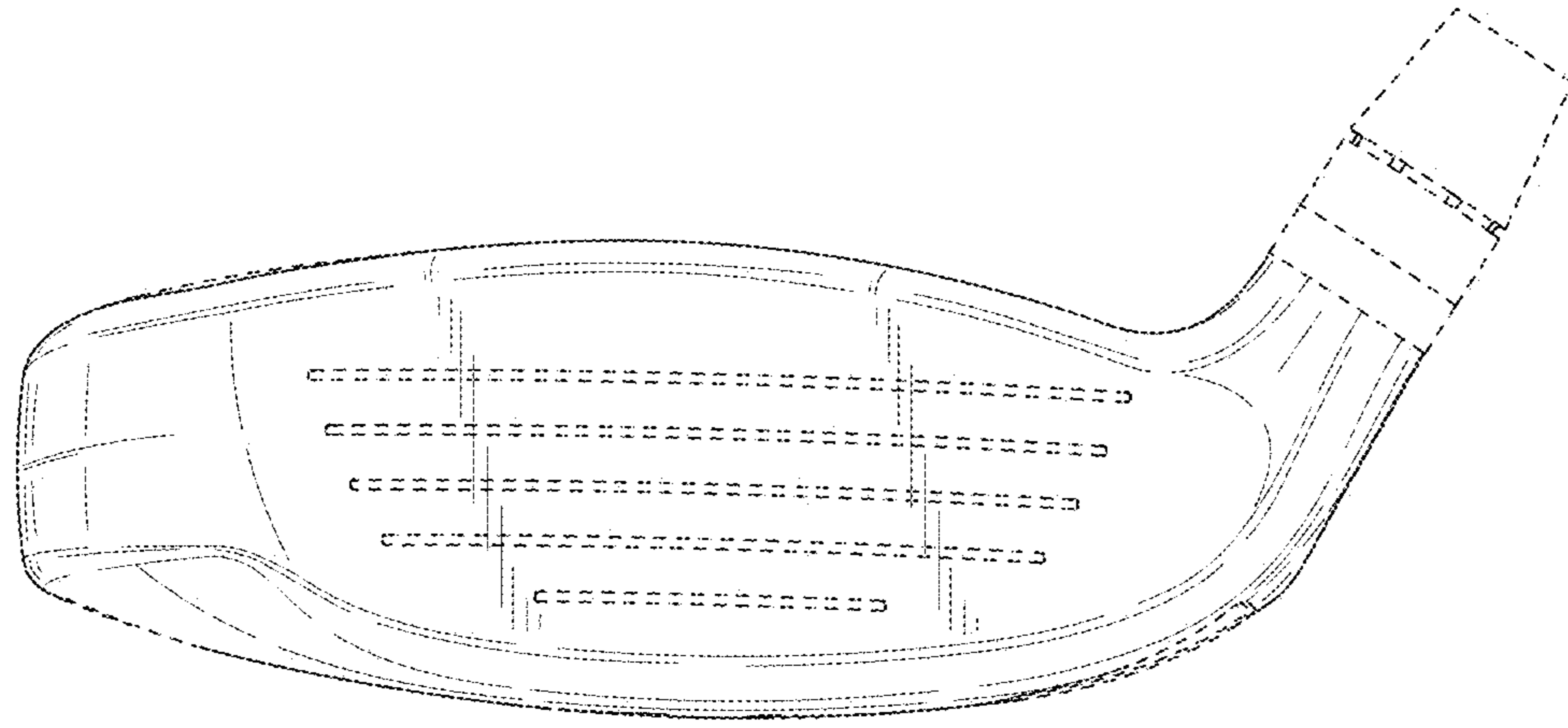




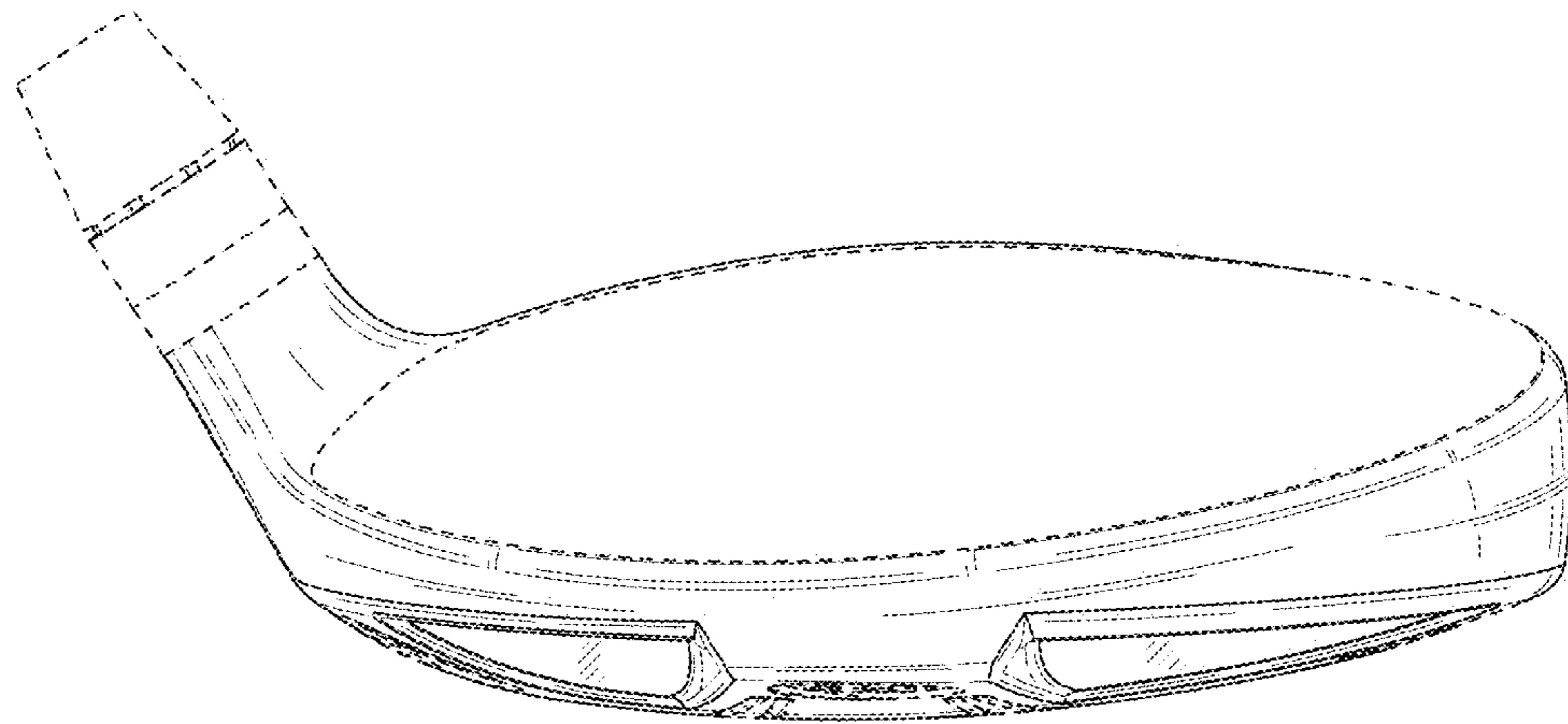
**FIG. 9**



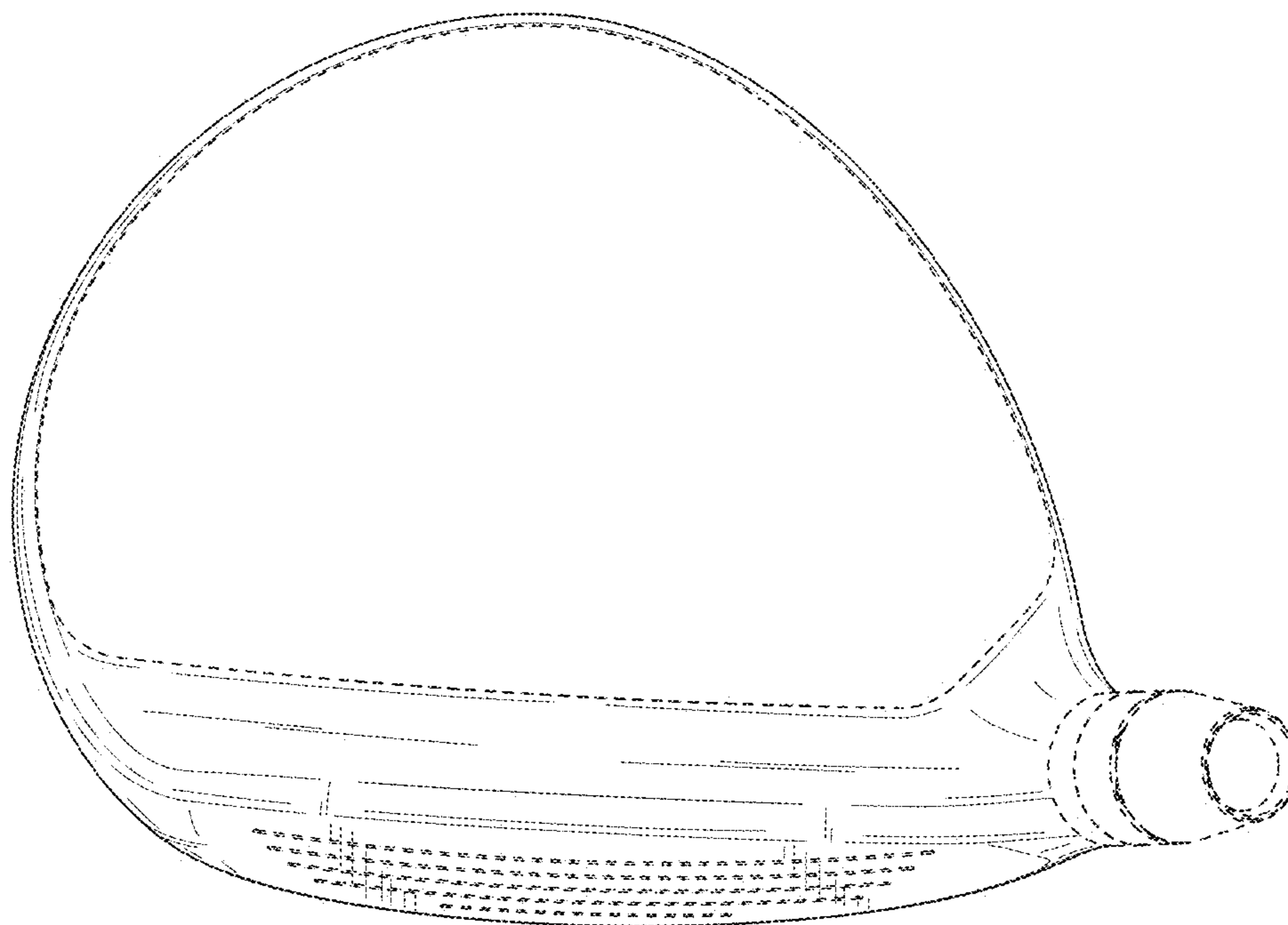
**FIG. 10**



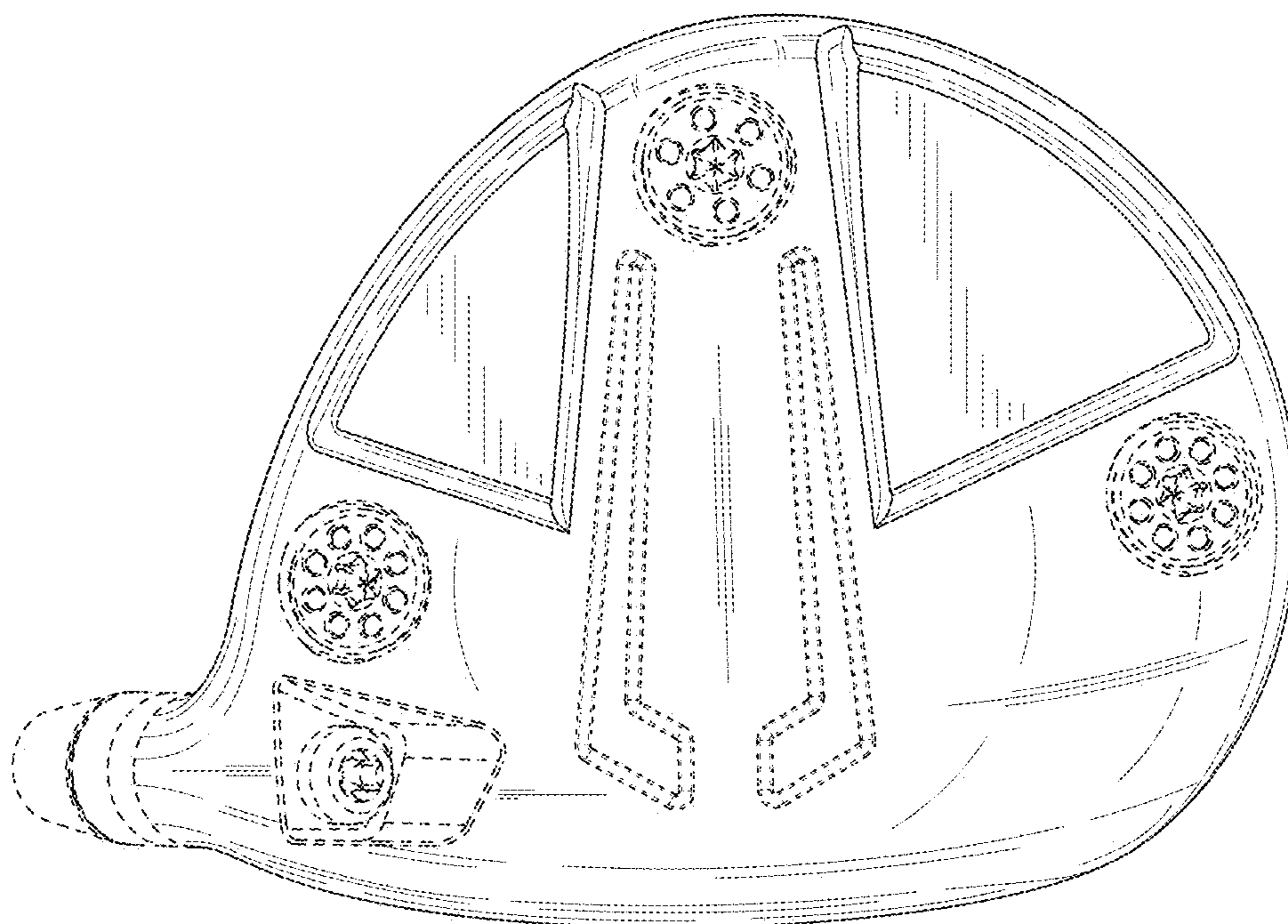
**FIG. 11**



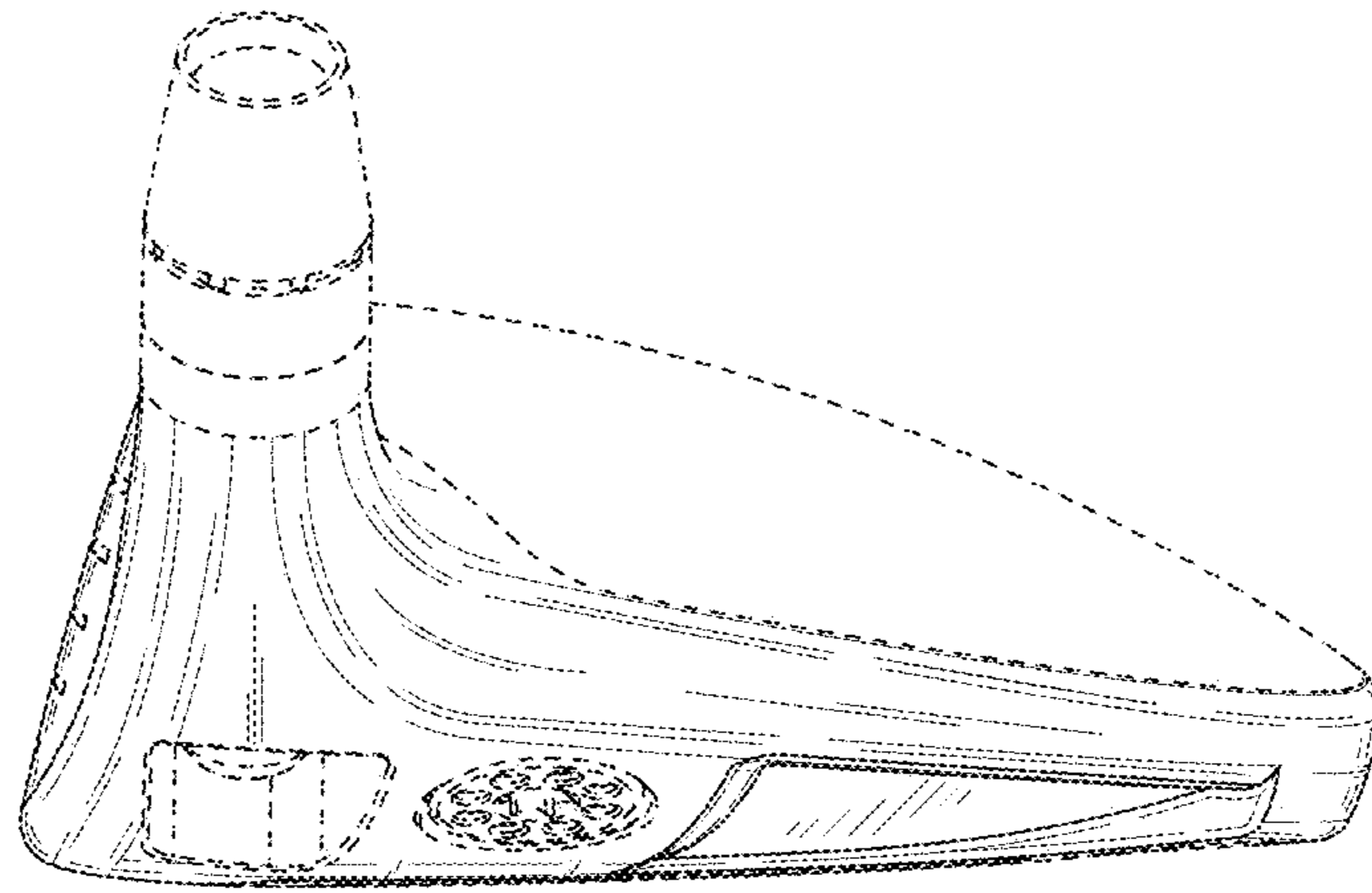
**FIG. 12**



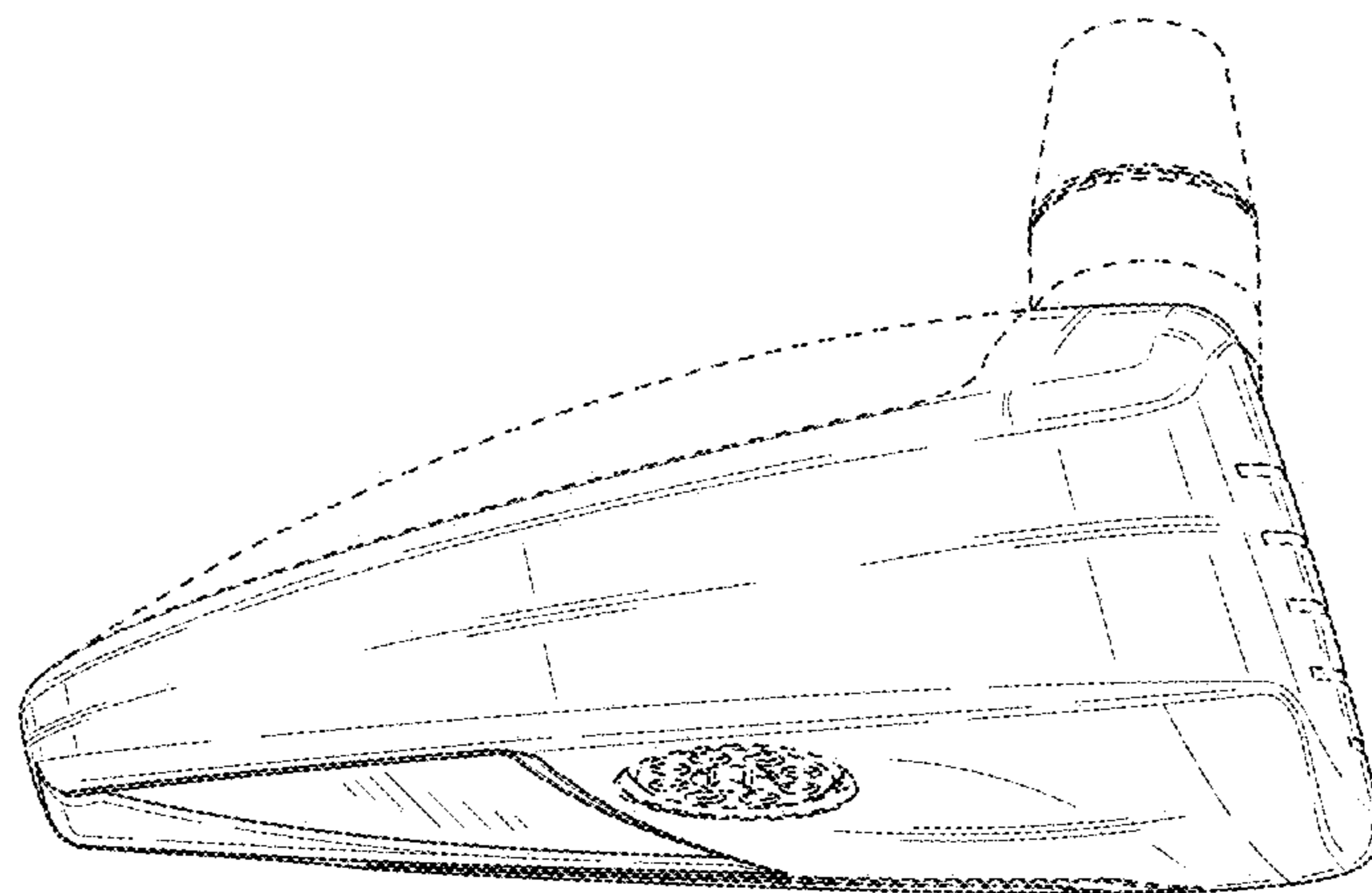
**FIG. 13**



**FIG. 14**



**FIG. 15**



**FIG. 16**