



US00D949270S

(12) **United States Design Patent**
Andrews

(10) **Patent No.:** **US D949,270 S**

(45) **Date of Patent:** **** Apr. 19, 2022**

(54) **GOLF CLUB HEAD**

(71) Applicant: **PARSONS XTREME GOLF, LLC**,
Scottsdale, AZ (US)

(72) Inventor: **Matthew T. Andrews**, Tempe, AZ (US)

(73) Assignee: **PARSONS XTREME GOLF, LLC**,
Scottsdale, AZ (US)

(**) Term: **15 Years**

(21) Appl. No.: **29/748,451**

(22) Filed: **Aug. 28, 2020**

(51) **LOC (13) Cl.** **21-02**

(52) **U.S. Cl.**
USPC **D21/736**

(58) **Field of Classification Search**
USPC **D21/736-746, 759**

(Continued)

(56) **References Cited**

U.S. PATENT DOCUMENTS

723,534 A 3/1903 Knight
922,444 A 5/1909 Youds

(Continued)

FOREIGN PATENT DOCUMENTS

JP 2004223184 A 8/2004
JP 2005160691 A 6/2005

(Continued)

OTHER PUBLICATIONS

Plugged In Golf (2015 Bettinardi Putters Review) [online]. Mar. 3, 2015, [retrieve Nov. 25, 2019] Retrieve from the internet.

(Continued)

Primary Examiner — Mitchell I. Siegel

(57) **CLAIM**

The ornamental design for a golf club head, as shown and described.

DESCRIPTION

FIG. 1 is a top perspective view of a golf club head;
FIG. 2 is a bottom perspective view of the golf club head of FIG. 1;
FIG. 3 is a front elevational view of the golf club head of FIG. 1;
FIG. 4 is a rear elevational view of the golf club head of FIG. 1;
FIG. 5 is a top view of the golf club head of FIG. 1;
FIG. 6 is a bottom view of the golf club head of FIG. 1;
FIG. 7 is a left side view of the golf club head of FIG. 1;
FIG. 8 is a right side view of the golf club head of FIG. 1;
FIG. 9 is a top perspective view of a second embodiment of a golf club head;
FIG. 10 is a bottom perspective view of the golf club head of FIG. 9;
FIG. 11 is a front elevational view of the golf club head of FIG. 9;
FIG. 12 is a rear elevational view of the golf club head of FIG. 9;
FIG. 13 is a top view of the golf club head of FIG. 9;
FIG. 14 is a bottom view of the golf club head of FIG. 9;
FIG. 15 is a left side view of the golf club head of FIG. 9;
FIG. 16 is a right side view of the golf club head of FIG. 9;
FIG. 17 is a top perspective view of a third embodiment of a golf club head;
FIG. 18 is a bottom perspective view of the golf club head of FIG. 17;
FIG. 19 is a front elevational view of the golf club head of FIG. 17;
FIG. 20 is a rear elevational view of the golf club head of FIG. 17;
FIG. 21 is a top view of the golf club head of FIG. 17;
FIG. 22 is a bottom view of the golf club head of FIG. 17;
FIG. 23 is a left side view of the golf club head of FIG. 17;
and,
FIG. 24 is a right side view of the golf club head of FIG. 17.
The broken lines shown on the drawings form no part of the claimed design.

1 Claim, 21 Drawing Sheets

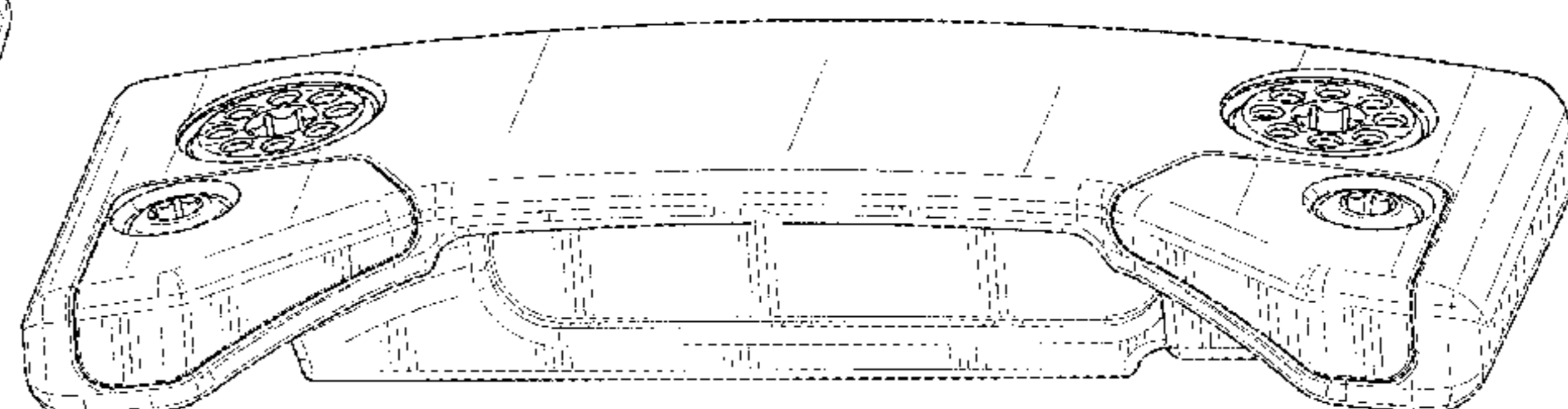
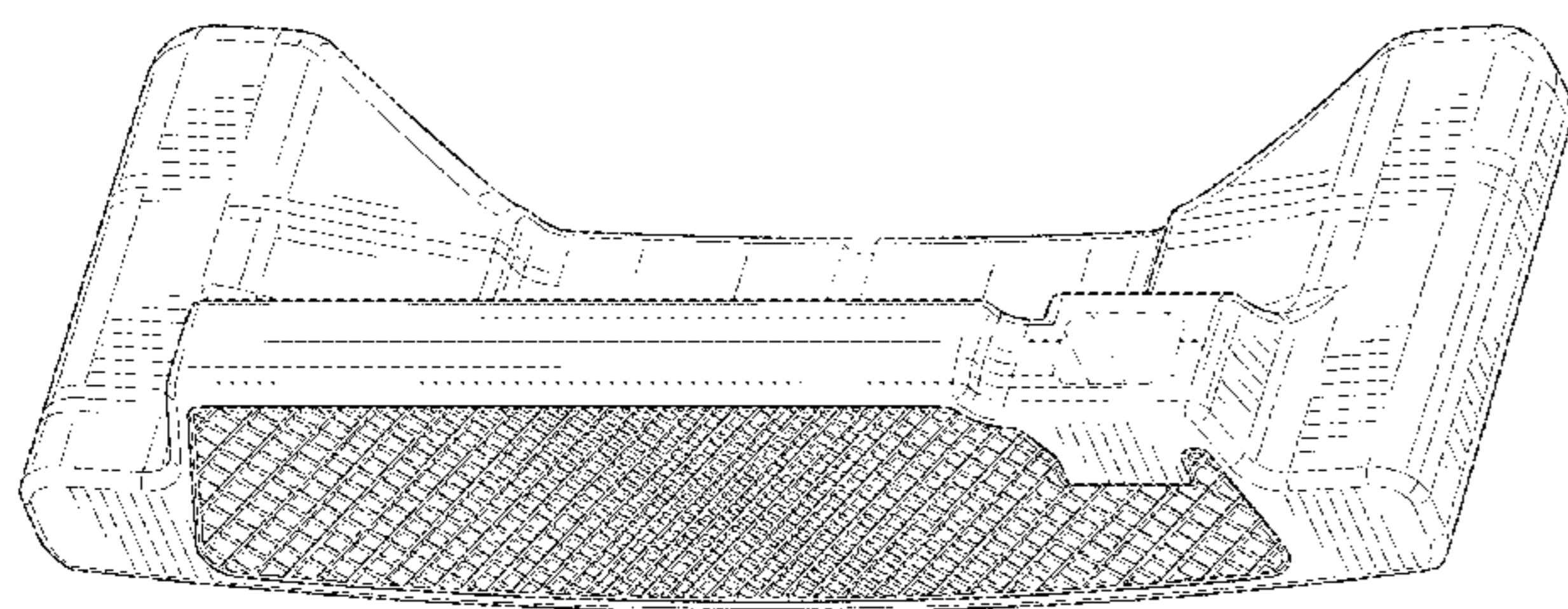

(58) Field of Classification Search

CPC A63B 53/00; A63B 53/04; A63B 53/007;
 A63B 53/065; A63B 53/0487; A63B
 60/00; A63B 60/46

See application file for complete search history.

(56)

References Cited

U.S. PATENT DOCUMENTS

1,094,599 A 4/1914 Samson
 D57,980 S 5/1921 Kraeuter
 D63,284 S 11/1923 Challis
 RE19,178 E 5/1934 Spiker
 4,043,562 A 8/1977 Shillington
 D248,783 S 8/1978 Long
 4,340,230 A 7/1982 Churchward
 D281,092 S 10/1985 Mills
 4,754,977 A 7/1988 Sahm
 4,869,507 A 9/1989 Sahm
 4,964,641 A 10/1990 Miesch et al.
 D313,451 S 1/1991 Shearer
 D335,317 S 5/1993 Shearer
 D335,692 S 5/1993 Antonious
 D336,757 S 6/1993 Antonious
 5,275,412 A 1/1994 Innes
 D350,582 S 9/1994 Miansian et al.
 5,390,919 A 2/1995 Stubbs et al.
 D356,131 S 3/1995 Trimble
 D360,444 S 7/1995 Takahashi et al.
 5,429,366 A 7/1995 McCabe
 D363,101 S 10/1995 Sturm
 D364,665 S 11/1995 Goodrich
 D365,864 S 1/1996 Sturm
 5,489,097 A 2/1996 Simmons
 D368,751 S 4/1996 Rife
 D369,393 S 4/1996 Takahashi et al.
 5,571,053 A 11/1996 Lane
 D378,688 S 4/1997 Cameron
 D380,514 S 7/1997 Markley
 D385,609 S 10/1997 Cameron
 5,683,307 A 11/1997 Rife
 D388,143 S 12/1997 Huan-Chiang
 D389,207 S 1/1998 Cameron
 D398,685 S 9/1998 Masuda
 5,807,190 A 9/1998 Krumme et al.
 D399,290 S 10/1998 Sizemore, Jr.
 D399,911 S 10/1998 Nicolette et al.
 5,839,974 A 11/1998 McAllister
 D405,836 S 2/1999 Nicolette et al.
 D409,701 S 5/1999 Ashcraft et al.
 D411,275 S 6/1999 Bottema et al.
 5,924,938 A 7/1999 Hines
 D415,809 S 10/1999 Bottema et al.
 D416,062 S 11/1999 Solheim et al.
 D416,969 S 11/1999 Solheim et al.
 D416,970 S 11/1999 Solheim et al.
 6,007,434 A 12/1999 Baker et al.
 D421,473 S 3/2000 Solheim et al.
 D422,655 S 4/2000 Hicks
 6,050,903 A 4/2000 Lake
 D426,276 S 6/2000 Besnard et al.
 6,089,993 A 7/2000 Woodward et al.
 D429,302 S 8/2000 Antonious
 6,110,057 A 8/2000 McKinnon
 D430,914 S 9/2000 Antonious
 D431,853 S 10/2000 Antonious
 D431,854 S 10/2000 Cameron
 D432,192 S 10/2000 Hicks
 D436,151 S 1/2001 Nicolette et al.
 D437,374 S 2/2001 Cameron
 D441,820 S 5/2001 Nicolette et al.
 D443,668 S 6/2001 Nicolette et al.
 D443,905 S 6/2001 Nicolette et al.
 D444,833 S 7/2001 Wells et al.
 D444,835 S 7/2001 Wahl et al.
 6,257,994 B1 7/2001 Antonious
 6,264,571 B1 7/2001 Lekavich

D449,664 S 10/2001 Beebe et al.
 D449,865 S 10/2001 Fife, Jr. et al.
 D450,799 S 11/2001 Nicolette et al.
 D451,973 S 12/2001 Wells et al.
 6,348,014 B1 2/2002 Chiu
 6,354,959 B1 3/2002 Nicolette et al.
 6,394,910 B1 5/2002 McCarthy
 D472,949 S 4/2003 Serrano
 D474,821 S 5/2003 Wells et al.
 D474,949 S 5/2003 Schaffeld et al.
 D482,087 S 11/2003 Burrows
 6,652,390 B2 11/2003 Bradford
 D483,086 S 12/2003 Schweigert et al.
 D486,539 S 2/2004 Burrows
 D486,872 S 2/2004 Schweigert et al.
 D488,200 S 4/2004 Olsavsky et al.
 D490,487 S 5/2004 Burrows
 D498,276 S 11/2004 Schweigert et al.
 D500,823 S 1/2005 Aldrich
 6,902,496 B2 6/2005 Solheim et al.
 6,902,498 B2 6/2005 Sullivan et al.
 D511,801 S 11/2005 Garcia
 D512,114 S 11/2005 Garcia
 D512,116 S 11/2005 Mirafior et al.
 6,988,955 B2 1/2006 Stoakes
 6,988,956 B2 1/2006 Cover et al.
 D520,088 S 5/2006 Parr
 D531,242 S 10/2006 Adams
 7,125,341 B1 10/2006 D'Eath
 D532,067 S 11/2006 Soracco et al.
 7,153,220 B2 12/2006 Lo
 D534,595 S 1/2007 Hasebe
 7,156,752 B1 1/2007 Bennett
 D536,401 S 2/2007 Kawami
 D536,403 S 2/2007 Kawami
 D537,898 S 3/2007 Kuan et al.
 D538,371 S 3/2007 Kawami
 7,204,765 B2 4/2007 Cover et al.
 D542,869 S 5/2007 Adams
 D543,598 S 5/2007 Kuan et al.
 D543,601 S 5/2007 Kawami
 D555,219 S 11/2007 Lin
 D556,277 S 11/2007 Broom
 7,309,297 B1 12/2007 Solari
 D561,854 S 2/2008 Morris
 7,331,876 B2 2/2008 Klein
 7,351,162 B2 4/2008 Soracco et al.
 D569,461 S 5/2008 Morris
 D569,930 S 5/2008 Nehrbus
 7,396,289 B2 7/2008 Soracco et al.
 D577,085 S 9/2008 Nicolette et al.
 D577,086 S 9/2008 Nicolette et al.
 D579,506 S 10/2008 Nicolette et al.
 D579,995 S 11/2008 Nicolette et al.
 D582,497 S 12/2008 Rollinson
 7,473,189 B2 1/2009 Schweigert et al.
 7,491,131 B2 2/2009 Vinton
 D594,921 S 6/2009 Bettinardi
 D595,793 S 7/2009 Rollinson
 D599,425 S 9/2009 Laub
 D599,867 S 9/2009 Teramoto
 D600,763 S 9/2009 Cameron
 D601,214 S 9/2009 Serrano et al.
 D607,951 S 1/2010 Teramoto
 7,744,485 B2 6/2010 Jones et al.
 D620,993 S 8/2010 Laub
 D621,461 S 8/2010 Serrano et al.
 D623,709 S 9/2010 Serrano et al.
 D631,925 S 2/2011 Broom
 7,887,432 B2 2/2011 Jones et al.
 D633,964 S 3/2011 Teramoto
 7,909,707 B2 3/2011 Klein
 7,918,745 B2 4/2011 Morris et al.
 7,927,226 B1 4/2011 Twitty
 D638,891 S 5/2011 Nicolette et al.
 7,942,758 B2 5/2011 Nakamura
 D639,369 S 6/2011 Miyamichi
 D642,643 S 8/2011 Nicolette et al.
 D643,485 S 8/2011 Nicolette et al.

(56)

References Cited

U.S. PATENT DOCUMENTS

D643,892 S 8/2011 McGrorty
 D645,104 S 9/2011 Nicolette et al.
 8,096,039 B2 1/2012 Soracco et al.
 D653,718 S 2/2012 Stokke et al.
 8,109,841 B2 2/2012 Miyamichi
 D655,361 S 3/2012 Ramsauer
 D661,753 S 6/2012 Cameron et al.
 D666,260 S 8/2012 Cynn
 D672,418 S 12/2012 Rollinson
 8,371,958 B2 2/2013 Treadwell
 8,376,878 B2 2/2013 Bennett et al.
 D688,339 S 8/2013 Hilton et al.
 D688,341 S 8/2013 Rollinson
 D691,226 S 10/2013 Hilton et al.
 8,608,590 B2 12/2013 Hackel et al.
 D699,308 S 2/2014 Rollinson
 8,696,492 B1 4/2014 Hocknell et al.
 D704,782 S 5/2014 Rollinson
 8,721,472 B2 5/2014 Kuan et al.
 8,790,193 B2 7/2014 Serrano et al.
 D711,483 S 8/2014 Wong
 D715,388 S 10/2014 Serrano et al.
 D722,350 S 2/2015 Schweigert
 D722,351 S 2/2015 Parsons et al.
 D722,352 S 2/2015 Nicolette et al.
 D723,120 S 2/2015 Nicolette
 D724,164 S 3/2015 Schweigert et al.
 D725,208 S * 3/2015 Schweigert D21/743
 D726,265 S 4/2015 Nicolette
 D726,846 S * 4/2015 Schweigert D21/743
 D730,462 S 5/2015 Becktor et al.
 D732,122 S 6/2015 Becktor
 D732,618 S 6/2015 Becktor et al.
 D733,234 S 6/2015 Nicolette
 D735,283 S * 7/2015 Solheim D21/743
 9,108,088 B2 8/2015 Serrano et al.
 D738,447 S * 9/2015 Schweigert D21/736
 D738,449 S 9/2015 Schweigert
 D739,487 S 9/2015 Schweigert
 D741,426 S 10/2015 Schweigert
 D746,926 S 1/2016 Parsons et al.
 D748,213 S 1/2016 Parsons et al.
 D748,215 S 1/2016 Parsons et al.
 9,233,283 B2 1/2016 Schweiger
 9,265,996 B1 2/2016 Abbott et al.
 D752,697 S 3/2016 Claveran
 D753,252 S 4/2016 Schweigert
 9,440,124 B2 9/2016 Parsons et al.
 9,498,685 B2 11/2016 Abbott et al.
 9,566,484 B1 2/2017 Abbott et al.
 D791,891 S 7/2017 Davis
 D794,146 S 8/2017 Davis
 D798,975 S 10/2017 Becktor
 D798,976 S 10/2017 Becktor
 D798,977 S 10/2017 Becktor
 D798,978 S 10/2017 Becktor
 D798,979 S 10/2017 Becktor
 D798,980 S 10/2017 Becktor
 D798,981 S 10/2017 Becktor et al.
 D799,619 S 10/2017 Becktor et al.
 D802,073 S 11/2017 Toulon
 D812,163 S * 3/2018 Kroloff D21/736

9,987,530 B2 6/2018 Jertson et al.
 10,173,105 B2 1/2019 Myers et al.
 D839,977 S 2/2019 Rollinson et al.
 D872,816 S * 1/2020 Parsons D21/736
 10,646,758 B2 * 5/2020 Schweigert A63B 53/0487
 D893,655 S * 8/2020 Schweigert D21/759
 D909,505 S * 2/2021 Schweigert D21/736
 D909,506 S * 2/2021 Schweigert D21/736
 D910,789 S * 2/2021 Schweigert D21/736
 D910,790 S * 2/2021 Schweigert D21/736
 D913,388 S * 3/2021 Nicolette D21/736
 D913,389 S * 3/2021 Schweigert D21/736
 D920,452 S * 5/2021 Parsons D21/736
 D924,345 S * 7/2021 Nicolette D21/736
 D924,346 S * 7/2021 Nicolette D21/736
 D925,673 S * 7/2021 Parsons D21/736
 D926,898 S * 8/2021 Schweigert D21/736
 D927,619 S * 8/2021 Andrews D21/736
 D928,259 S * 8/2021 Andrews D21/736
 D933,766 S * 10/2021 Parsons D21/736
 11,173,361 B2 * 11/2021 Schweigert A63B 53/0487
 D941,945 S * 1/2022 Nicolette D21/736
 2004/0138003 A1 7/2004 Grace
 2004/0180730 A1 9/2004 Franklin et al.
 2006/0052178 A1 3/2006 Franklin et al.
 2006/0094522 A1 5/2006 Tang et al.
 2006/0223649 A1 10/2006 Rife
 2007/0129163 A1 6/2007 Solari
 2007/0135229 A1 6/2007 Lo et al.
 2007/0142122 A1 6/2007 Bonneau
 2007/0207875 A1 9/2007 Kuan et al.
 2007/0238548 A1 10/2007 Johnson
 2008/0139333 A1 6/2008 Klein
 2008/0146372 A1 6/2008 John
 2008/0176672 A1 7/2008 Roach et al.
 2009/0029800 A1 1/2009 Jones et al.
 2010/0255922 A1 10/2010 Lueders
 2011/0165959 A1 7/2011 Klein
 2013/0165256 A1 6/2013 Stevenson
 2013/0210537 A1 8/2013 Ainscough et al.
 2015/0057100 A1 2/2015 Serrano et al.
 2015/0258390 A1 9/2015 DeFrancesco, Jr.
 2015/0306477 A1 10/2015 Parsons et al.
 2016/0016050 A1 1/2016 Rife
 2016/0346649 A1 12/2016 Jertson et al.
 2018/0001163 A1 1/2018 Becktor et al.
 2018/0311545 A1 11/2018 Lambeth et al.

FOREIGN PATENT DOCUMENTS

KR 200377377 Y1 3/2005
 KR 200403045 Y1 12/2005
 KR 20100065481 A 6/2010
 KR 101773069 B1 8/2017

OTHER PUBLICATIONS

TourSpecGolf (Gold's Factory Multi Weighted Custom Putter), Published Nov. 20, 2010 [<http://blog.toursecgolf.com/golds-factory-multi-weighted-custom-putter/>], Retrieved May 17, 2020.
 U.S. Appl. No. 29/523,587, Schweigert "Golf Club Head," filed Apr. 10, 2015.

* cited by examiner

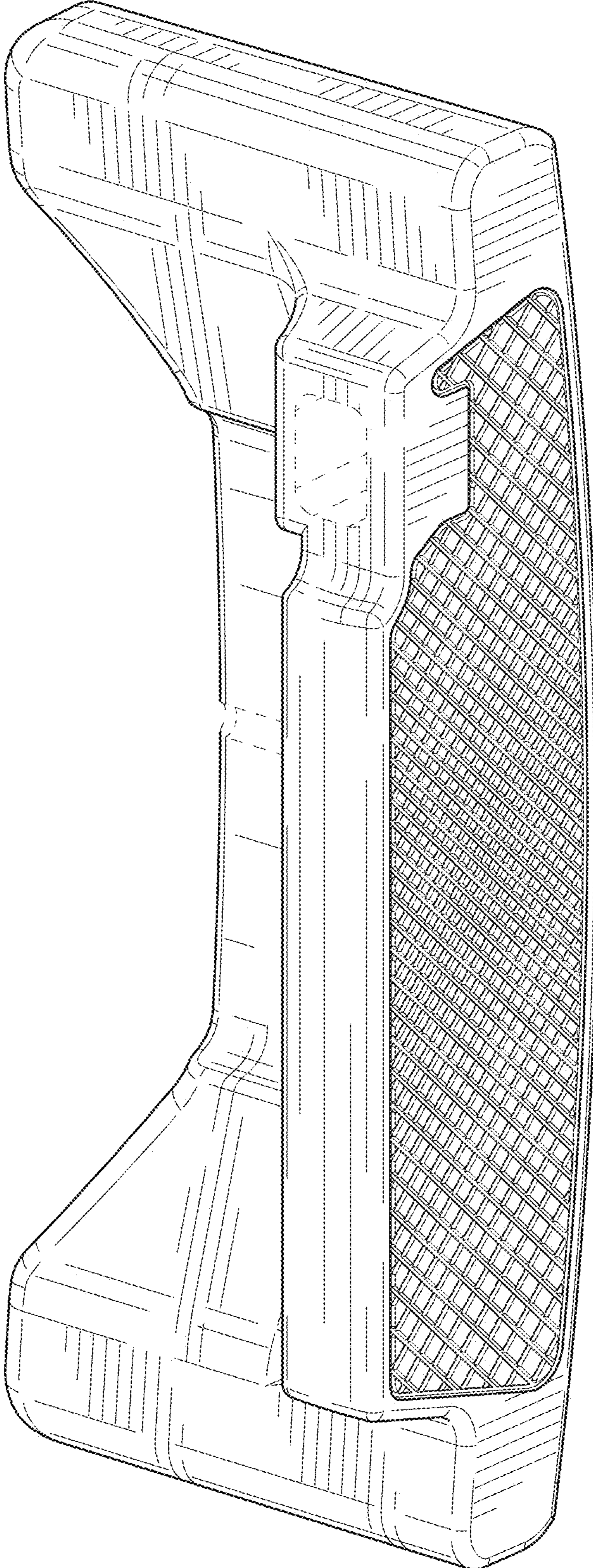

FIG. 1

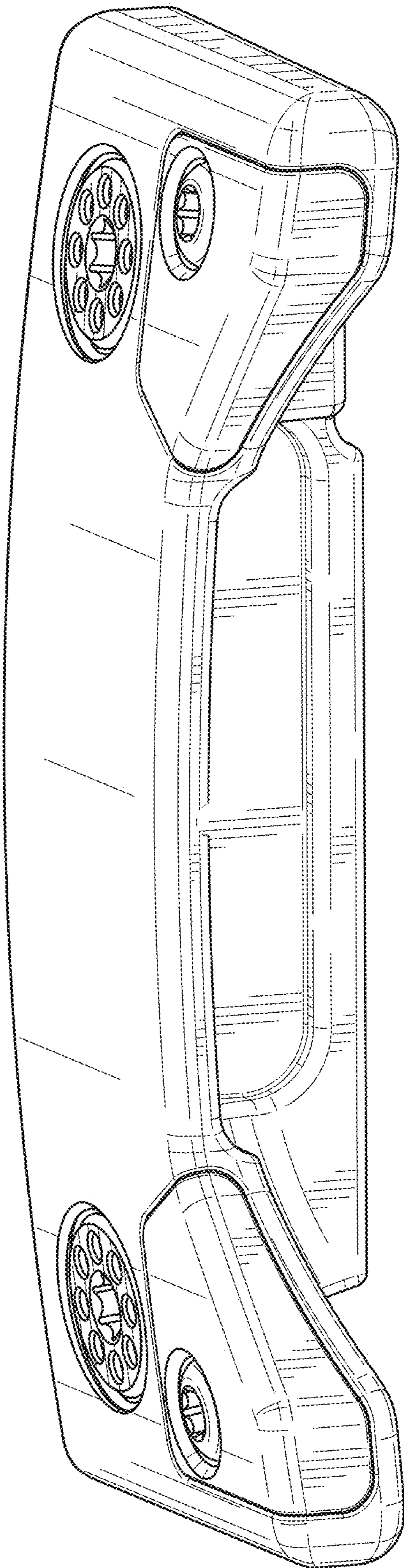

FIG. 2

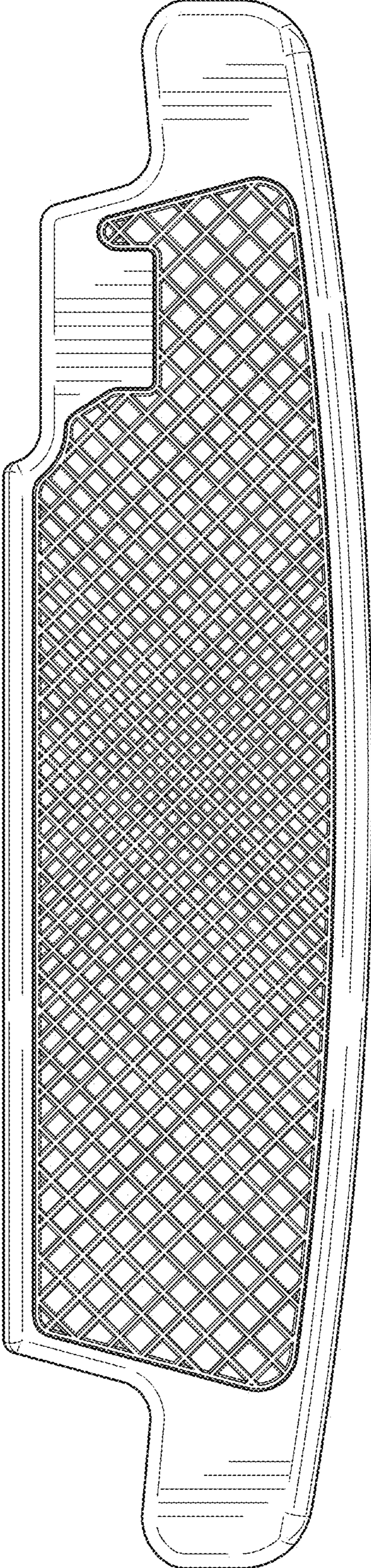

FIG. 3

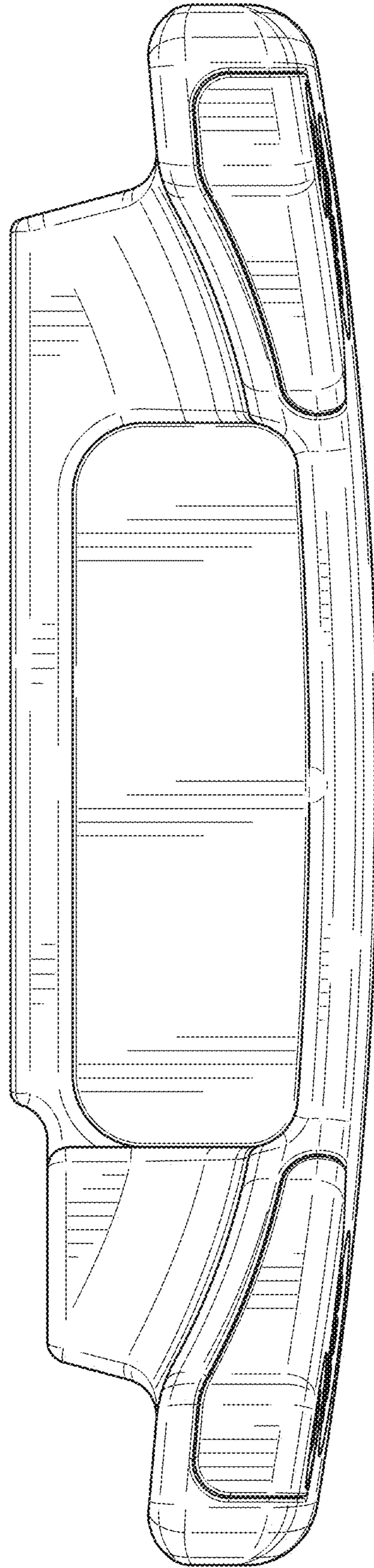

FIG. 4

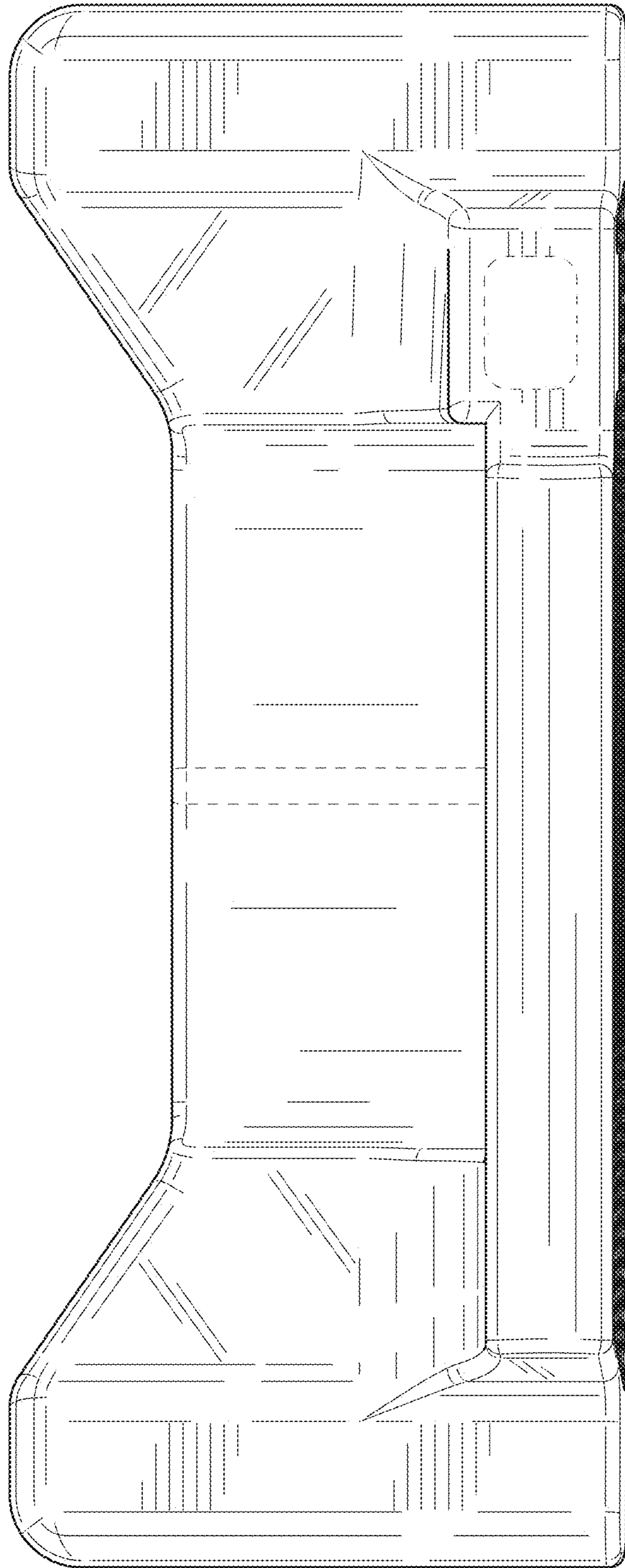

FIG. 5

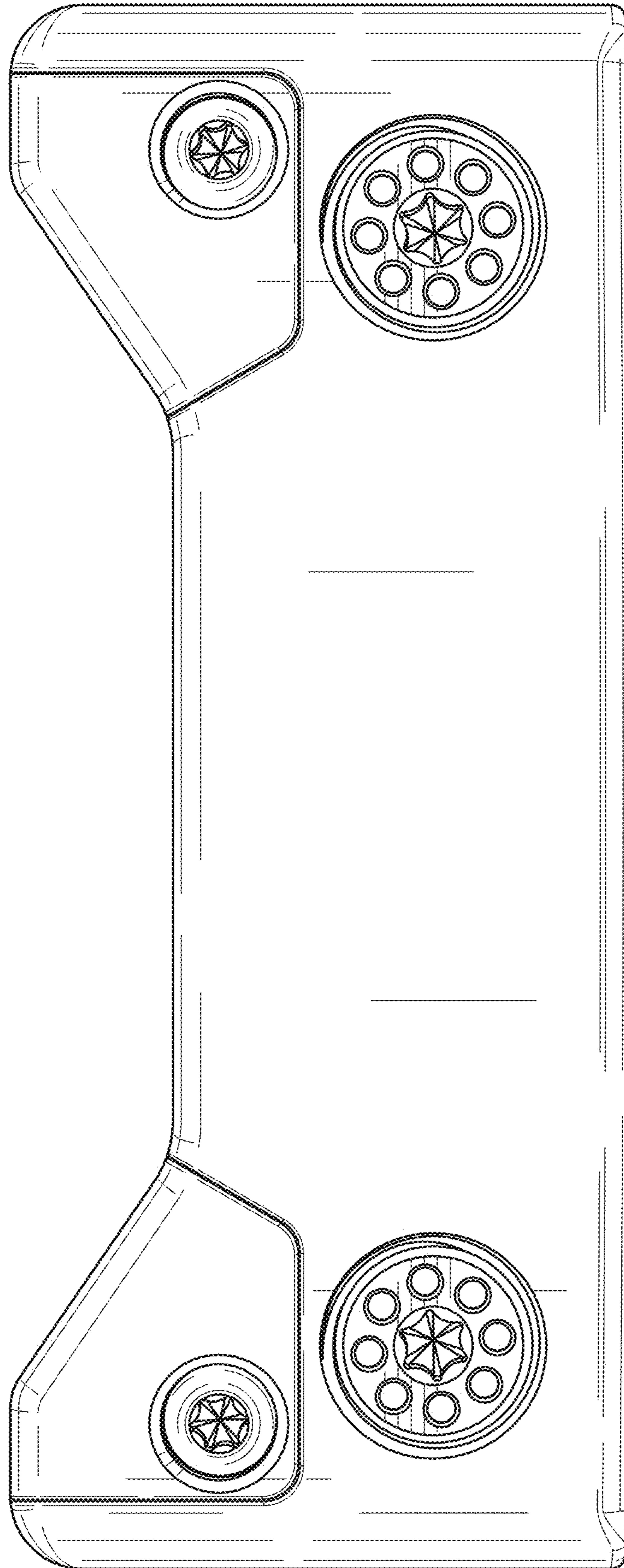

FIG. 6

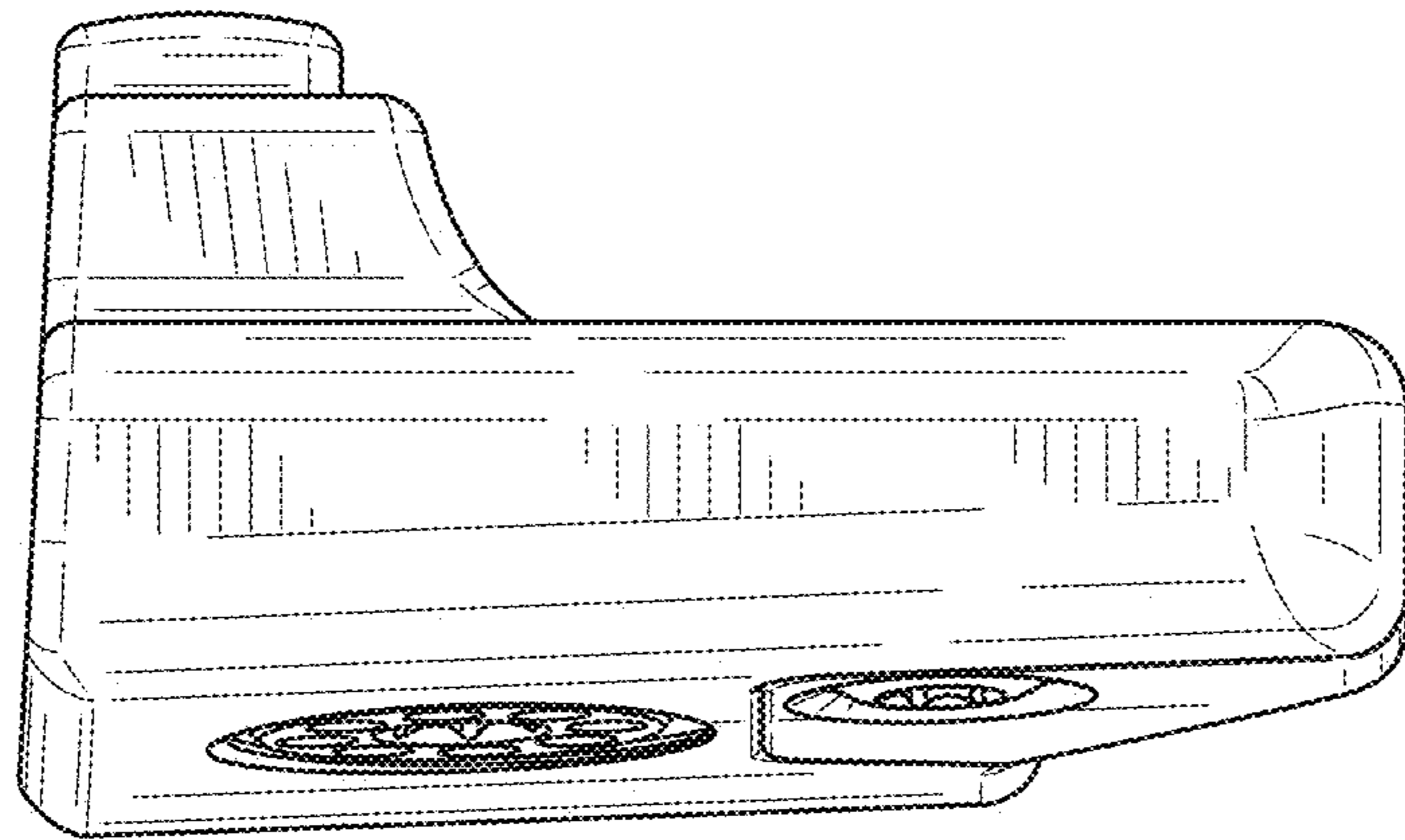

FIG. 7

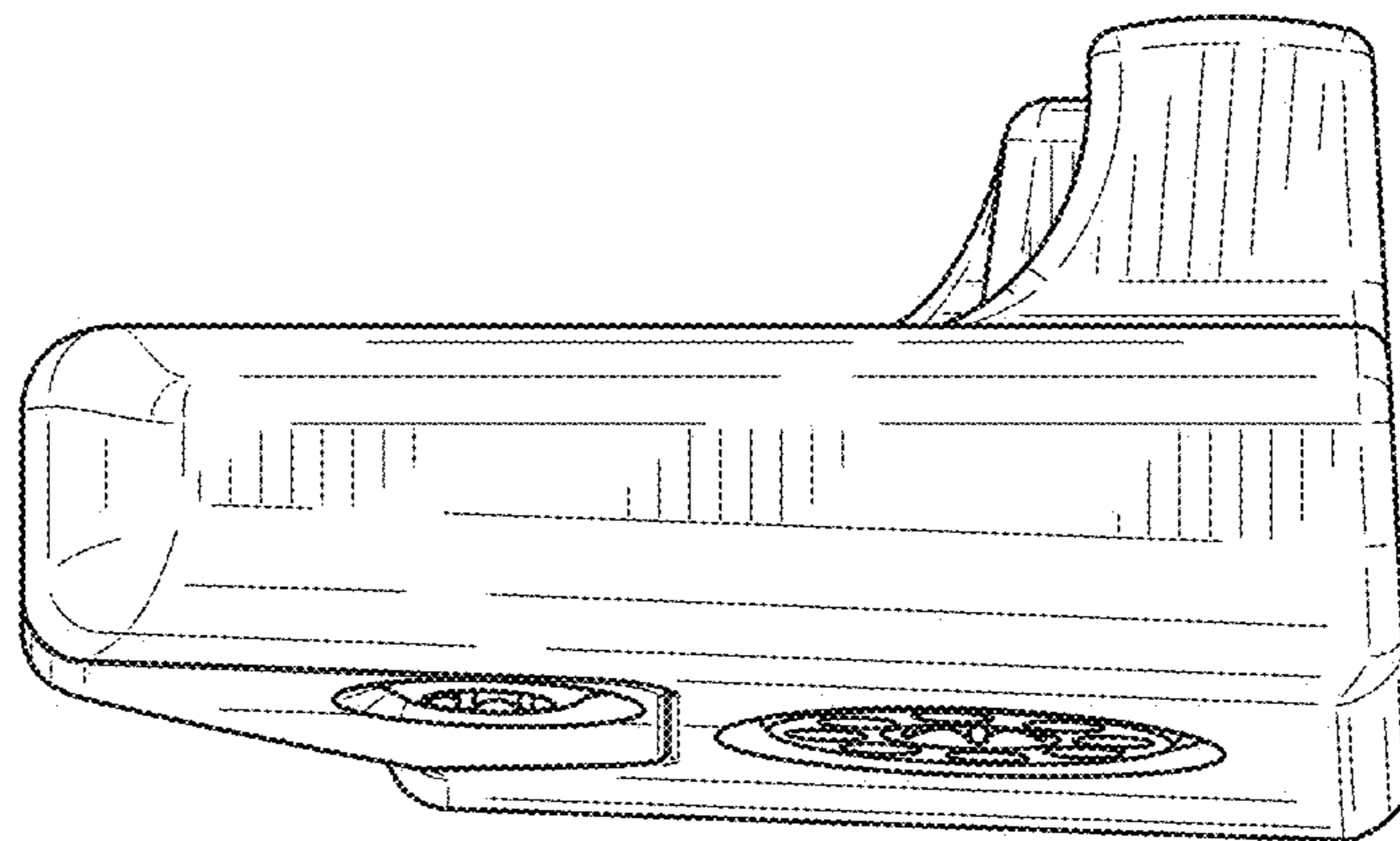

FIG. 8

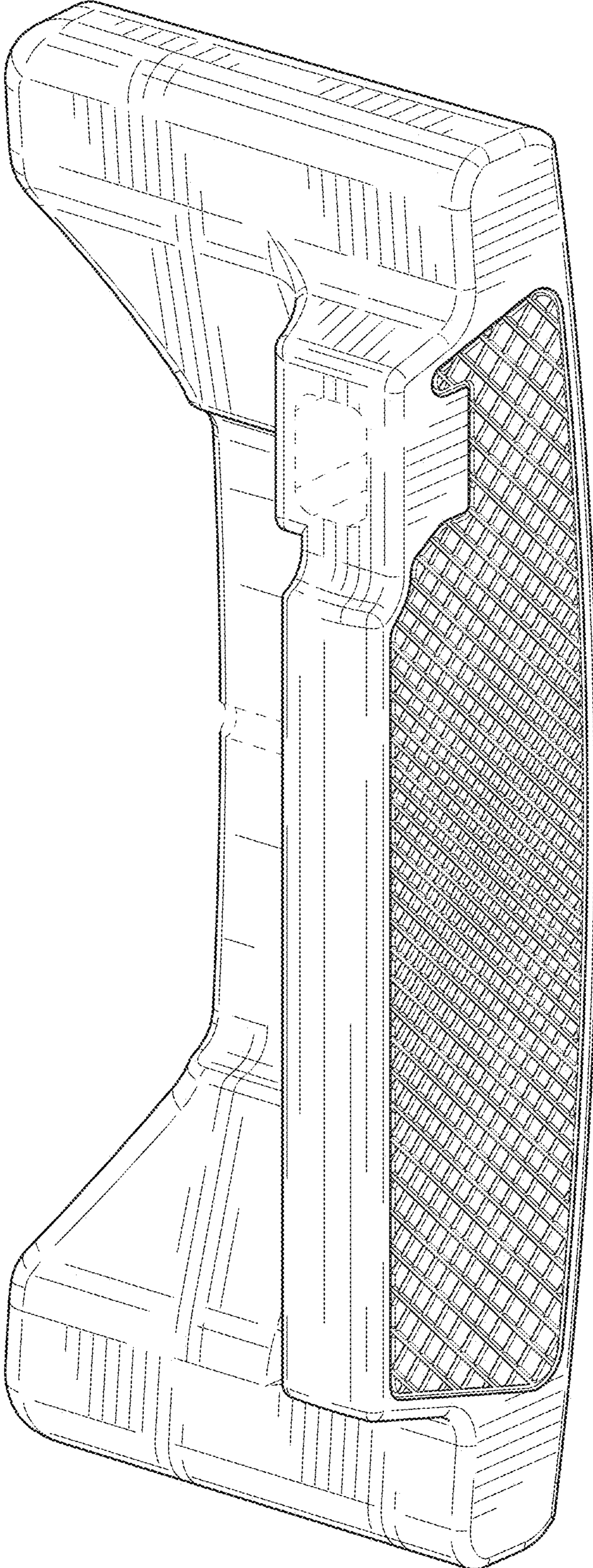

FIG. 9

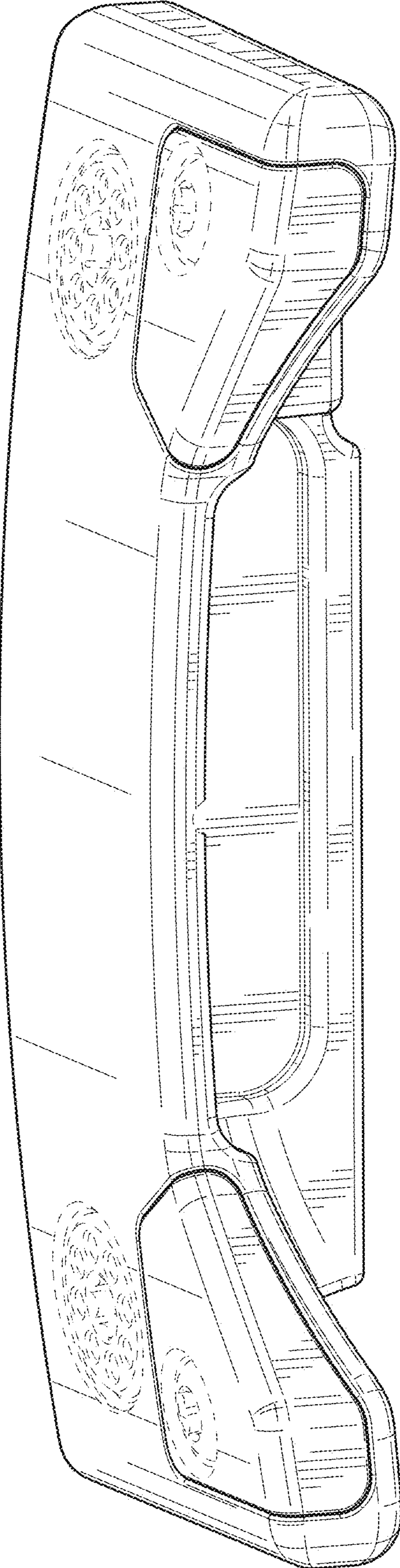

FIG. 10

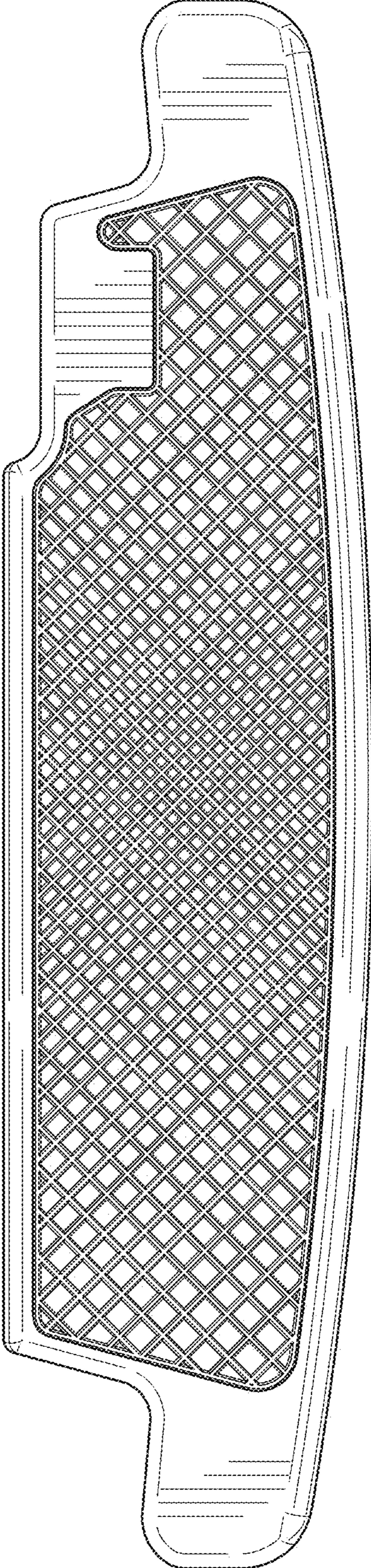

FIG. 11

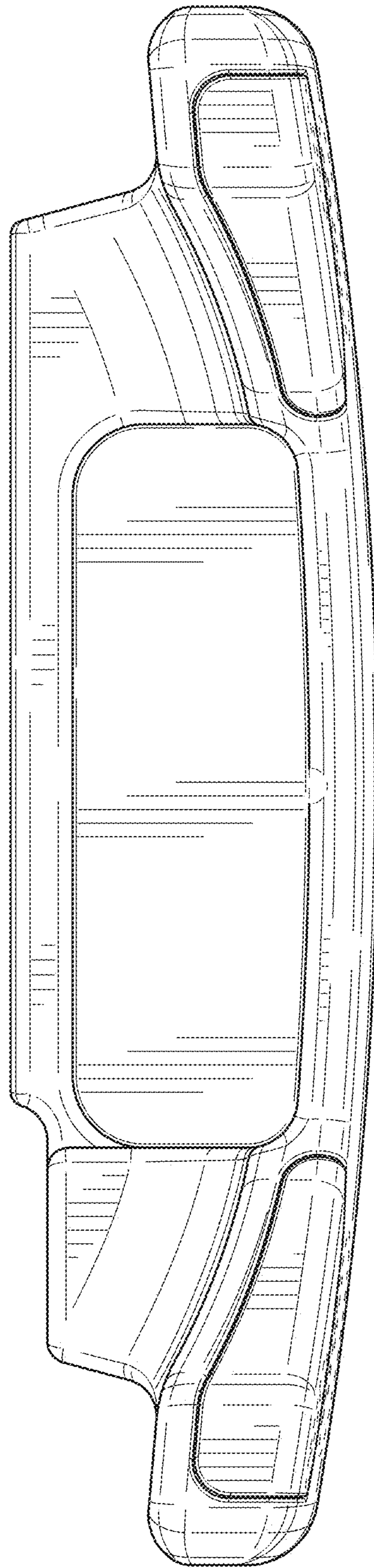

FIG. 12

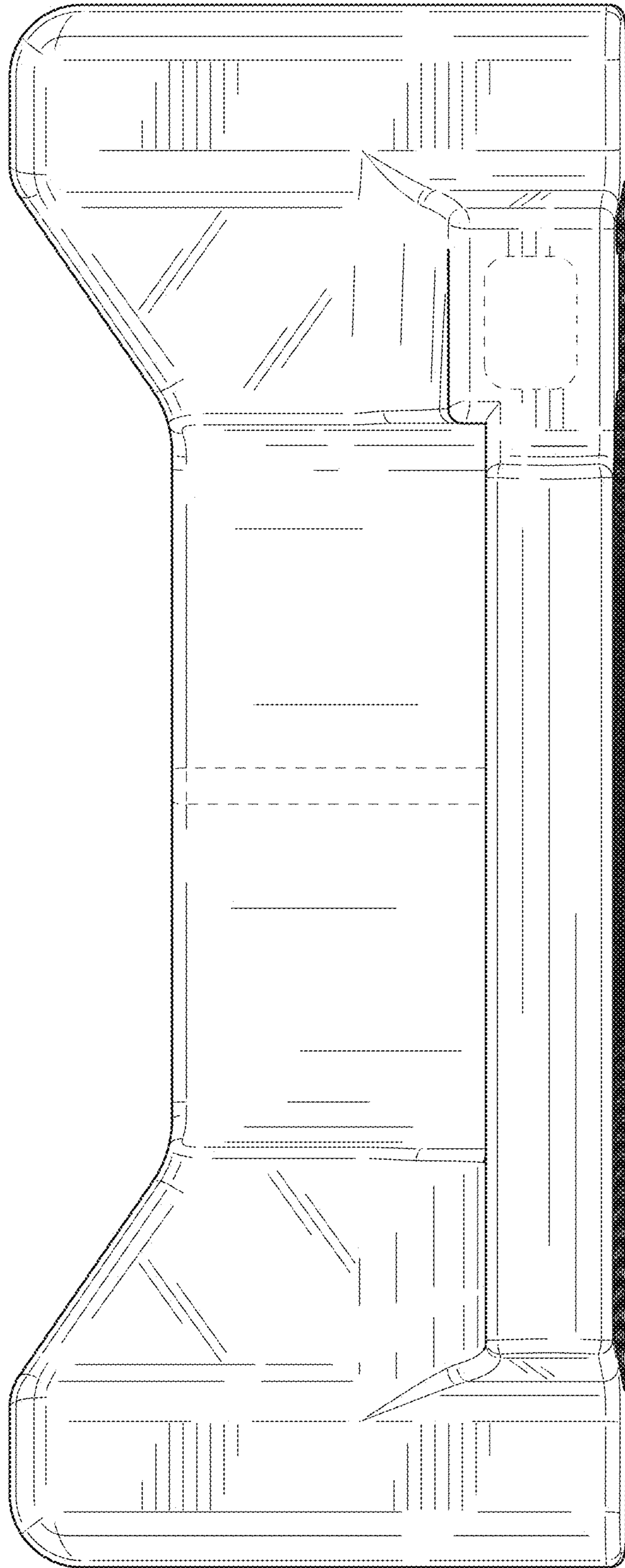

FIG. 13

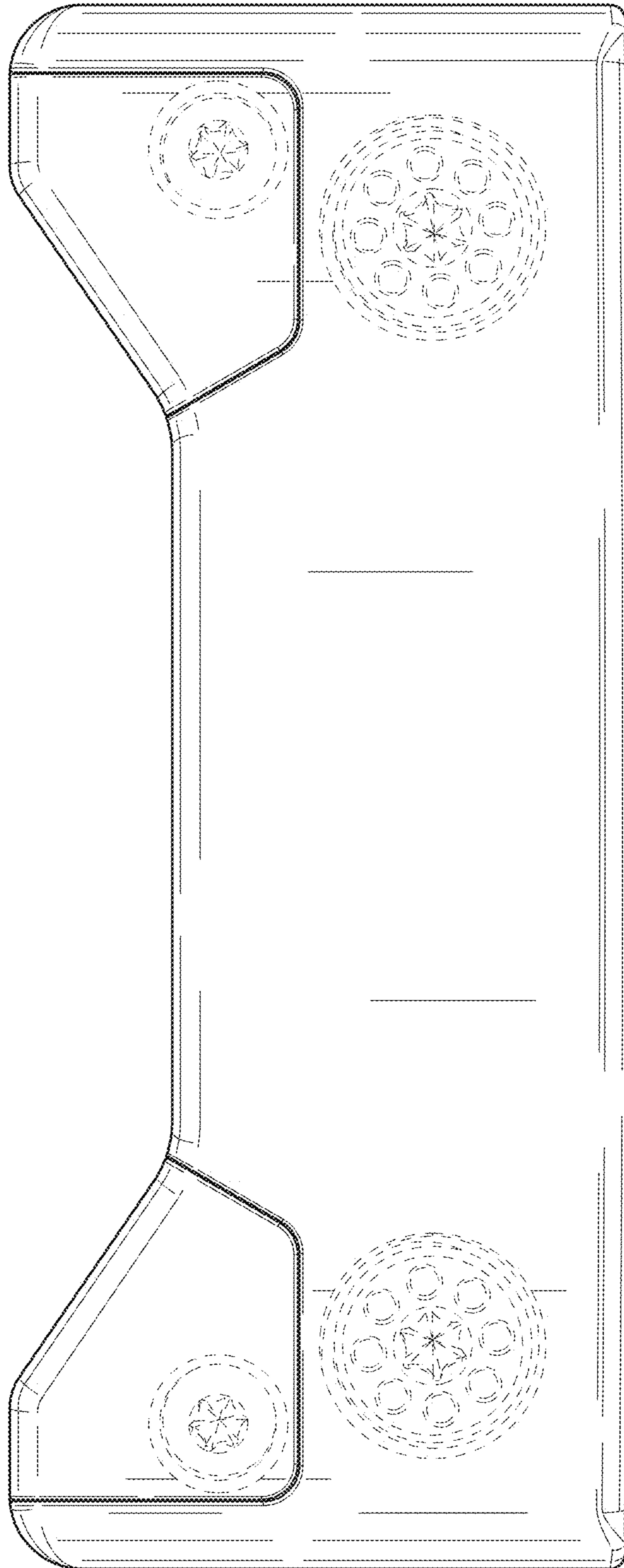

FIG. 14

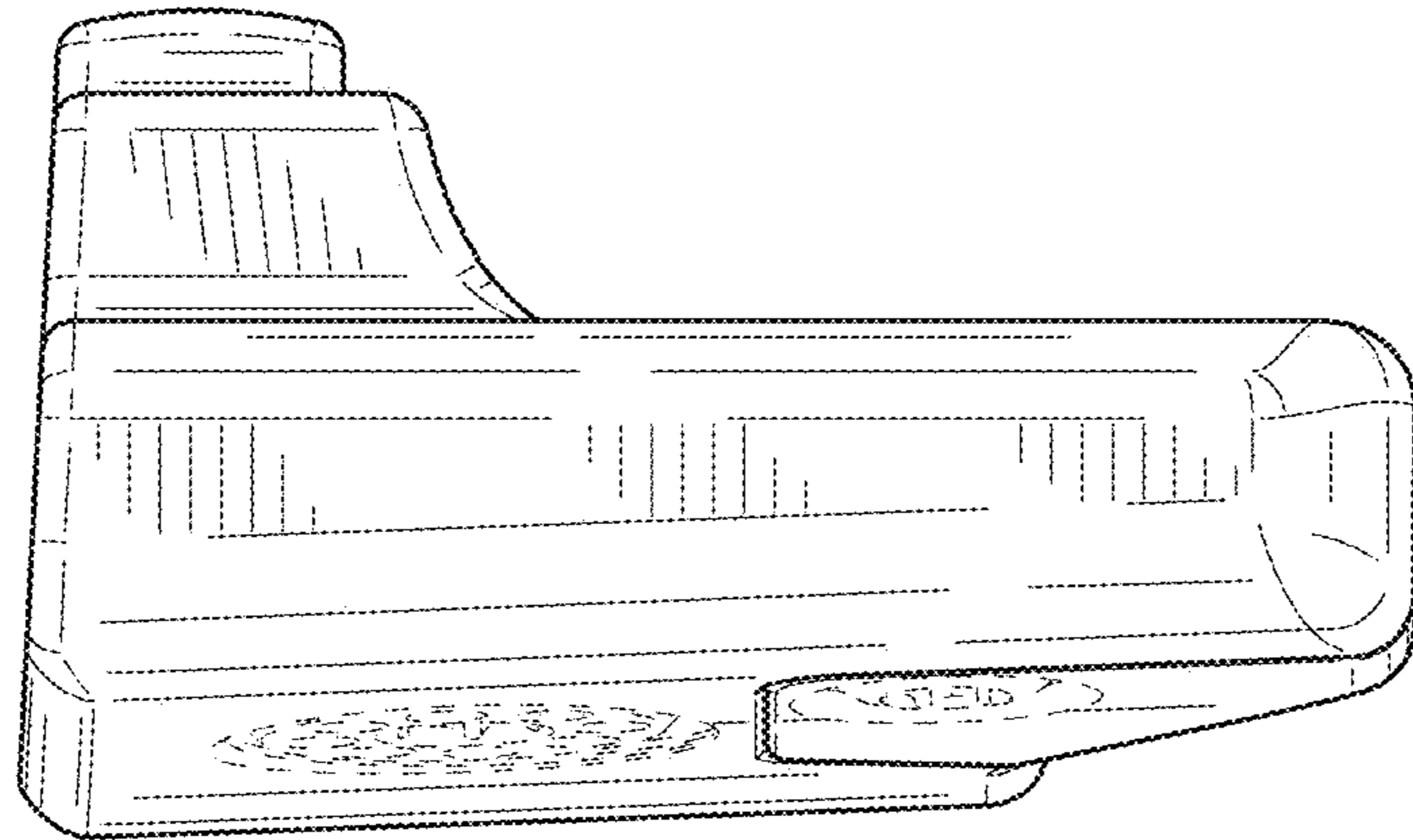

FIG. 15

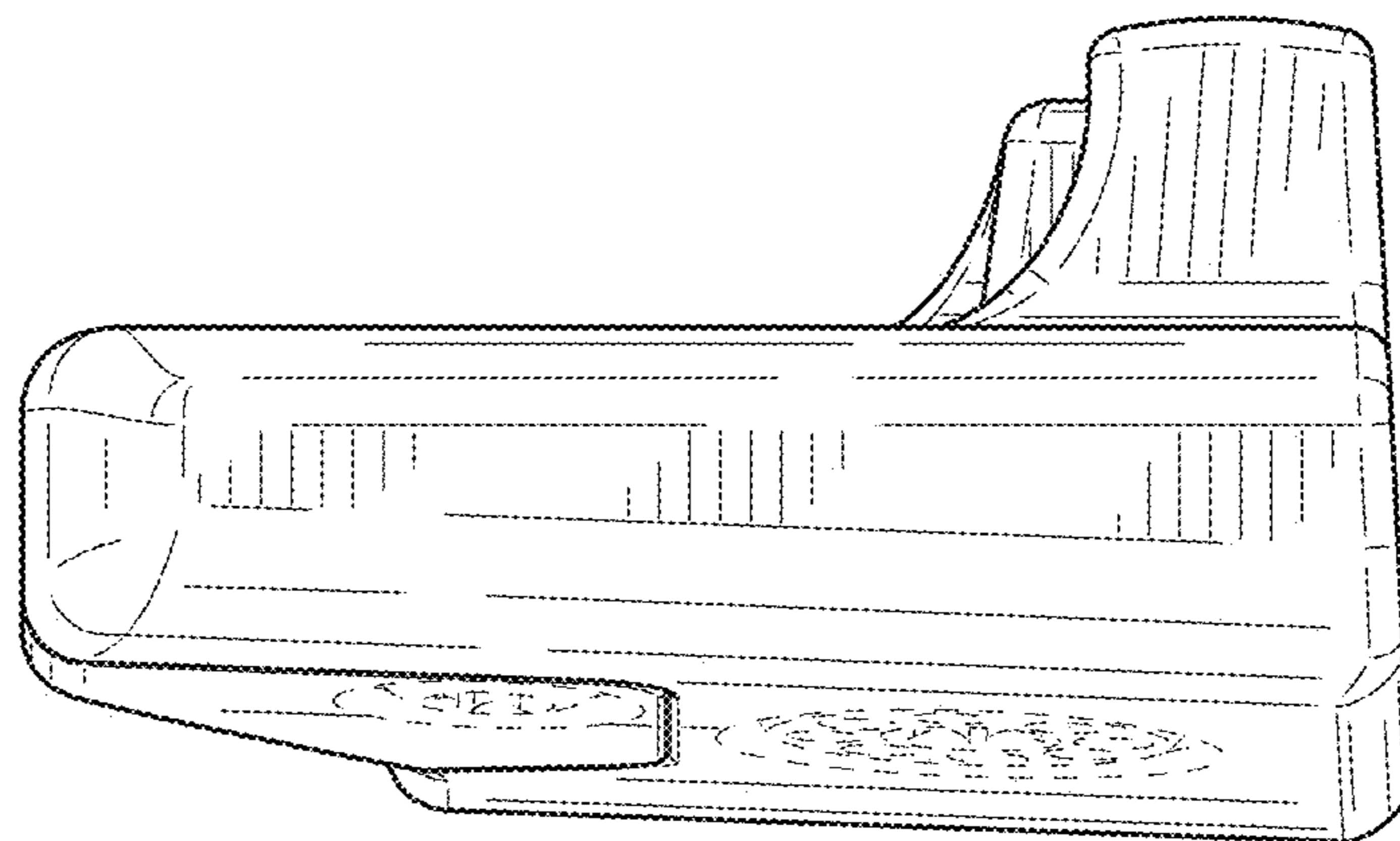

FIG. 16

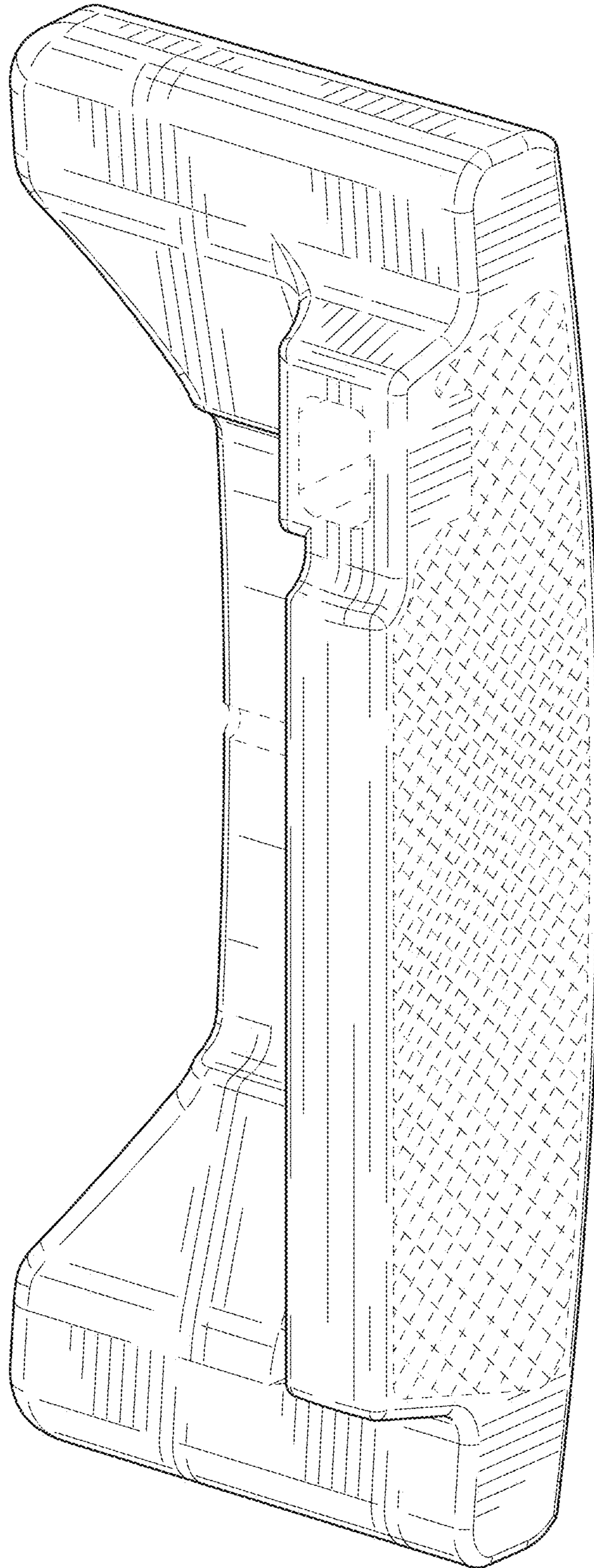

FIG. 17

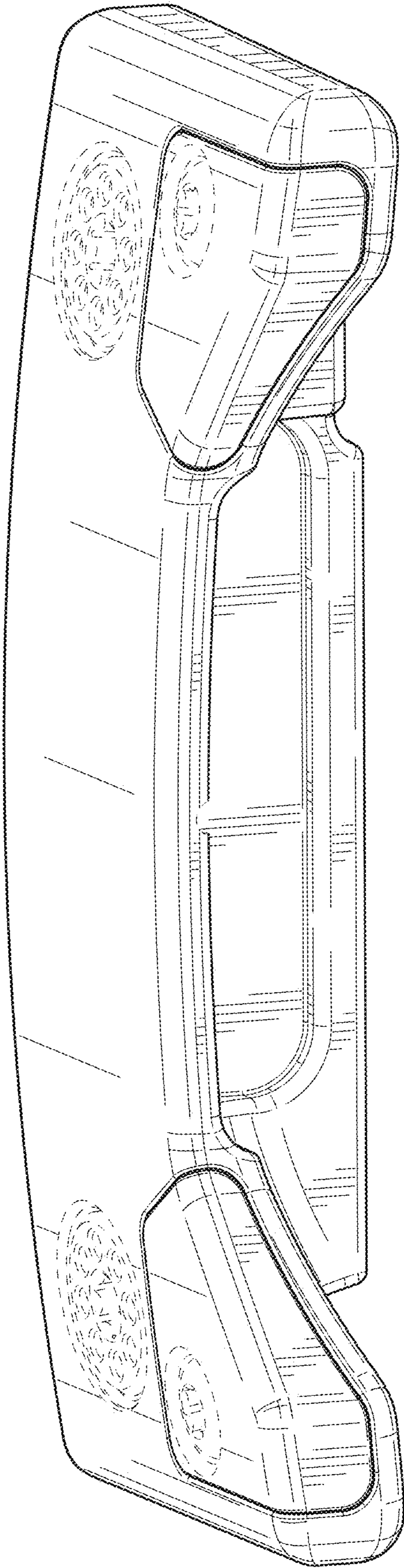

FIG. 18

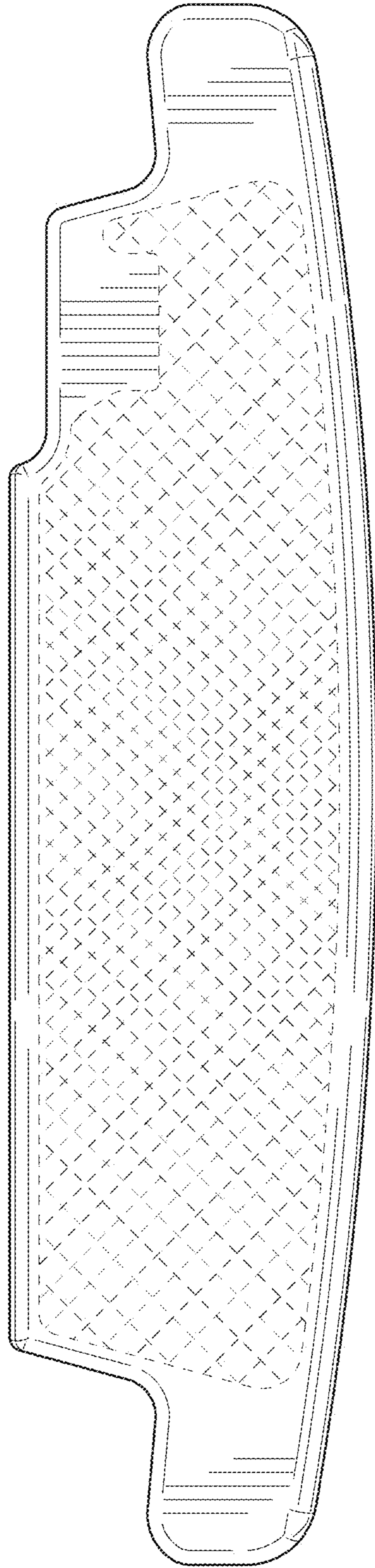

FIG. 19

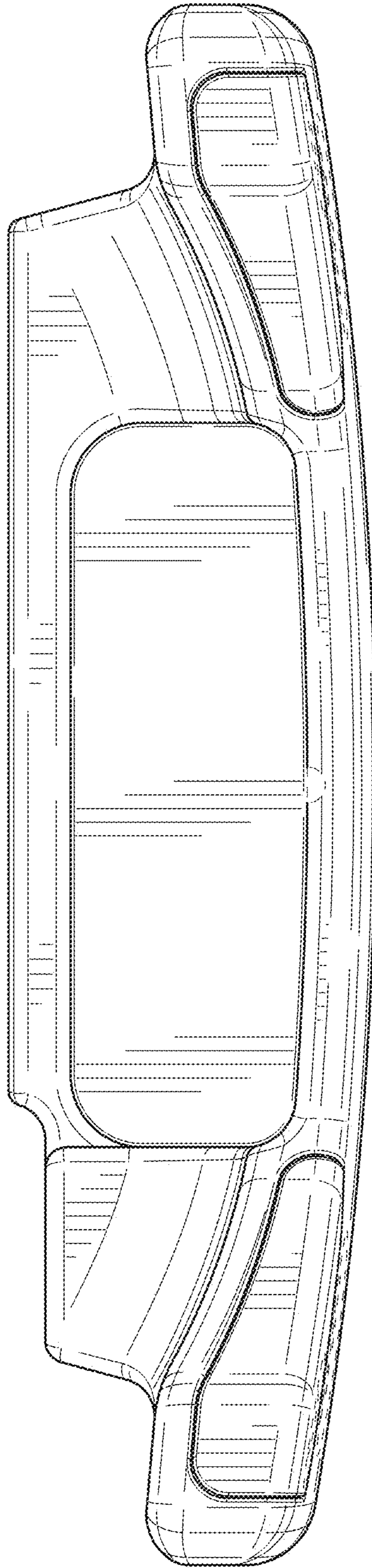

FIG. 20

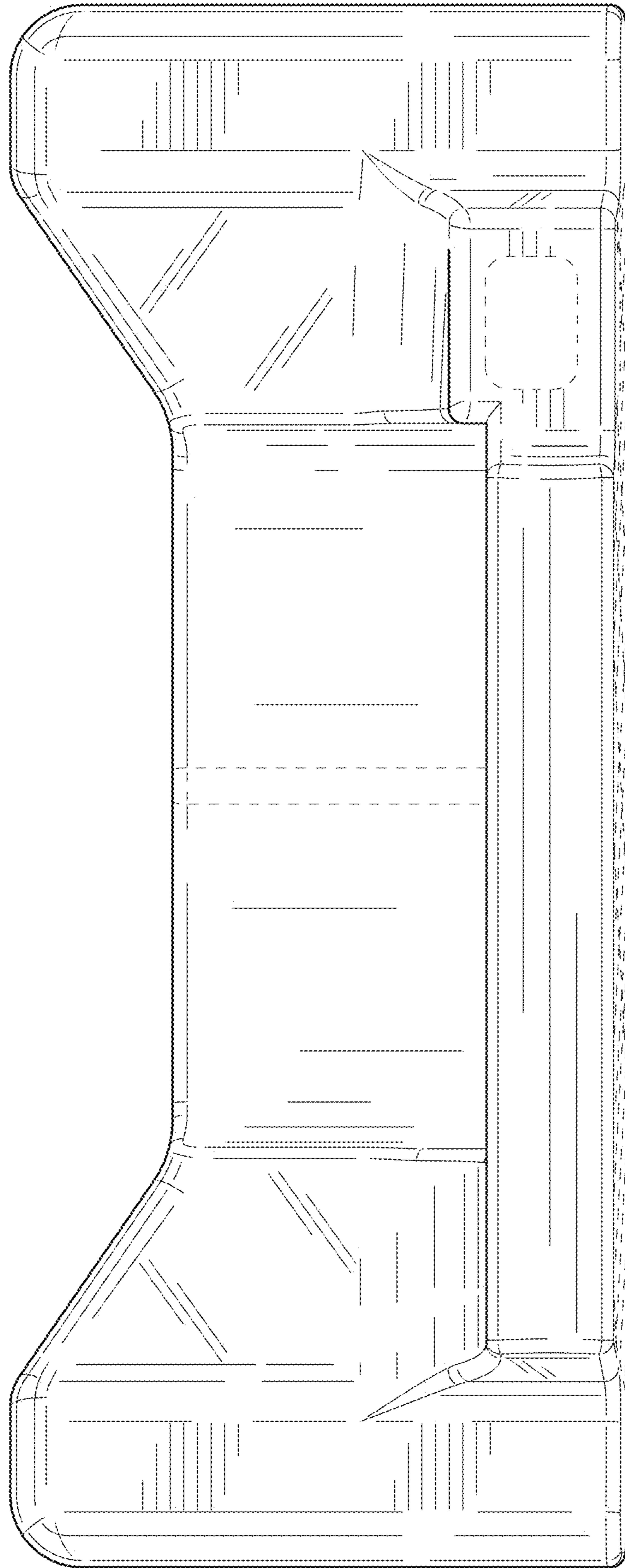

FIG. 21

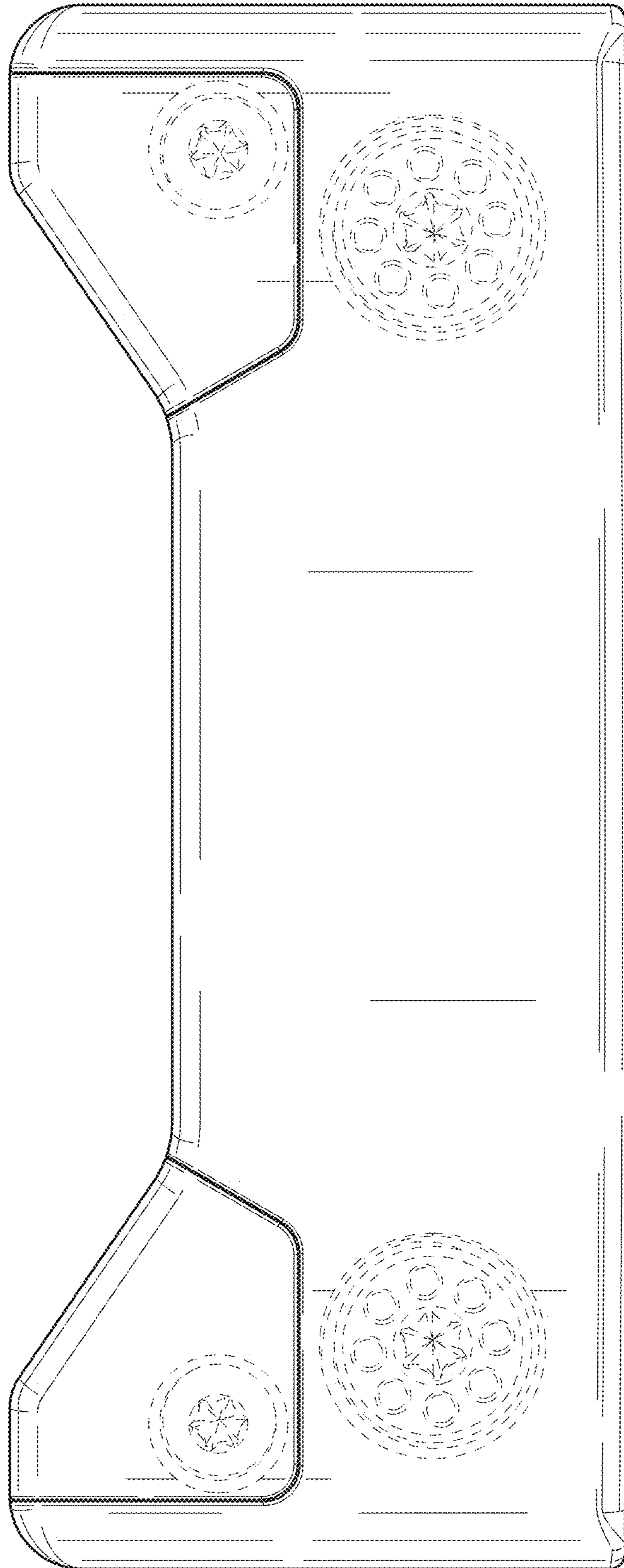

FIG. 22

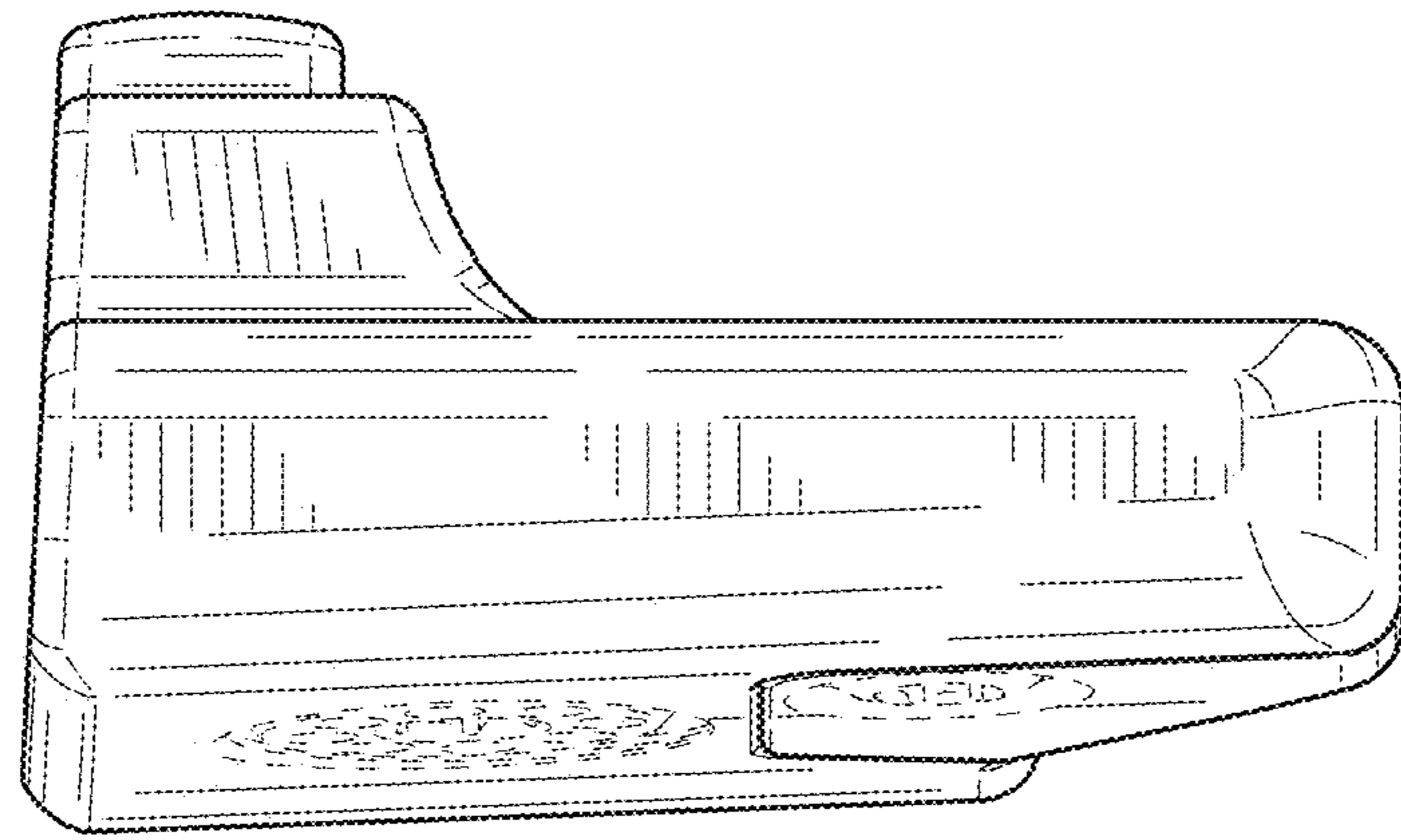

FIG. 23

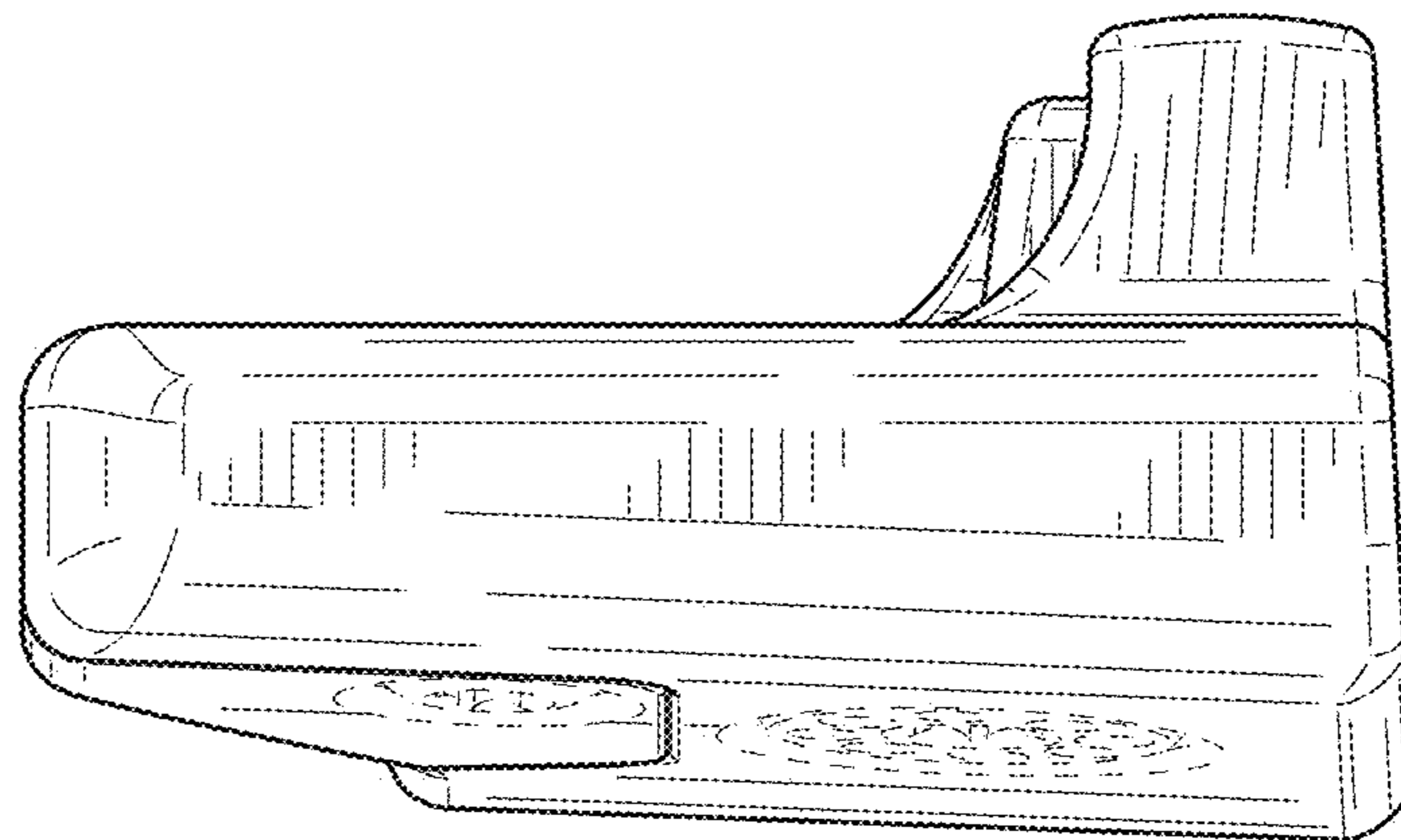

FIG. 24