



US00D949264S

(12) **United States Design Patent** (10) **Patent No.:** **US D949,264 S**
Dunahay (45) **Date of Patent:** **** Apr. 19, 2022**

- (54) **WALL MOUNT**
- (71) Applicant: **Coulter Ventures, LLC.**, Columbus, OH (US)
- (72) Inventor: **Nash Dunahay**, Blacklick, OH (US)
- (73) Assignee: **Coulter Ventures, LLC.**, Columbus, OH (US)
- (**) Term: **15 Years**
- (21) Appl. No.: **29/728,972**
- (22) Filed: **Mar. 23, 2020**

- D259,512 S 6/1981 Hallen
 - 4,323,236 A 4/1982 Szabo
 - D264,756 S 6/1982 Andersson
 - D265,111 S 6/1982 Lynn
 - D269,691 S 7/1983 Ornstein et al.
- (Continued)

FOREIGN PATENT DOCUMENTS

- CN 202812711 U 3/2013
 - EP 2400205 A1 12/2011
- (Continued)

OTHER PUBLICATIONS

Screenshot of Level Mount tv mount from <https://www.youtube.com/watch?v=YUVvZr3qTrc>, dated Mar. 26, 2012, accessed Jun. 2, 2020.

(Continued)

Primary Examiner — Michael A Maharajh
 (74) *Attorney, Agent, or Firm* — Banner & Witcoff, Ltd.

(57) **CLAIM**

The ornamental design for a wall mount, as shown and described.

DESCRIPTION

FIG. 1 is a top, front, right perspective view of a wall mount showing my new design;
 FIG. 2 is a front view thereof;
 FIG. 3 is a top view thereof;
 FIG. 4 is a bottom view thereof;
 FIG. 5 is a right side view thereof; and,
 FIG. 6 is a left side view thereof.
 The broken lines immediately adjacent to the shaded area are directed to boundary lines, which form no part of the claimed design. The broken lines in the drawings are for the purpose of illustrating portions of the wall mount which form no part of the claimed design.

1 Claim, 5 Drawing Sheets

Related U.S. Application Data

- (63) Continuation of application No. 29/650,239, filed on Jun. 5, 2018, now Pat. No. Des. 879,216.
- (51) **LOC (13) Cl.** **21-02**
- (52) **U.S. Cl.**
USPC **D21/694**; D21/686
- (58) **Field of Classification Search**
USPC D21/662, 673, 686, 691, 694, 826;
D25/62, 66, 68, 119, 126, 136; D6/329;
D8/323, 354
CPC A63B 21/00047; A63B 21/078; A63B
21/169; A63B 71/023
See application file for complete search history.

(56) **References Cited**

U.S. PATENT DOCUMENTS

- 88,047 A 3/1869 Lawrence
- D47,725 S 8/1915 Heulings
- D47,726 S 8/1915 Heulings
- 1,410,149 A 3/1922 Williams
- 2,855,200 A 10/1958 Blickman
- D210,469 S 3/1968 Sejersen
- 3,948,513 A * 4/1976 Pfothenhauer A63B 17/04
482/142
- 4,111,414 A 9/1978 Roberts

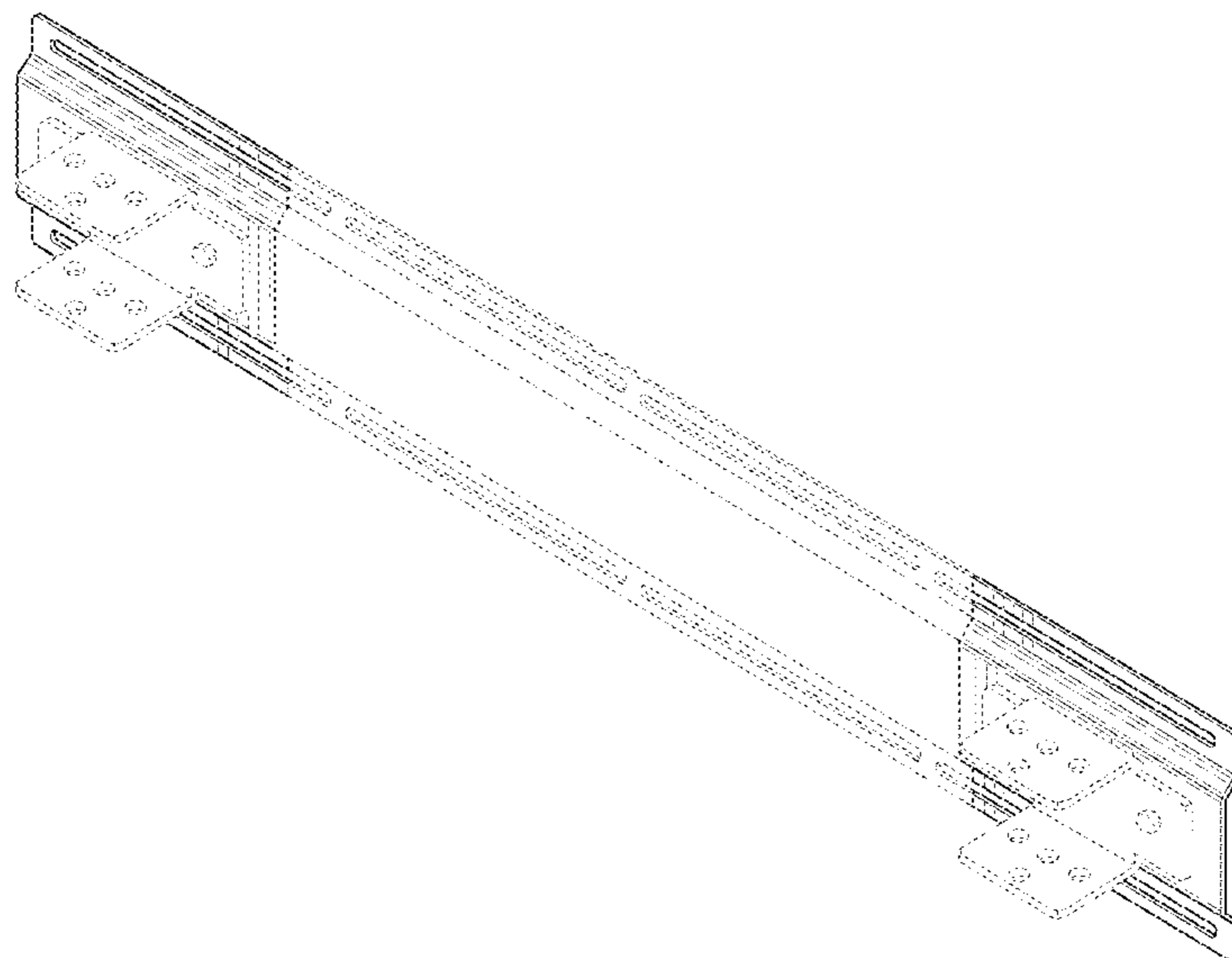

US D949,264 S

(56)

References Cited

U.S. PATENT DOCUMENTS

D273,334 S	4/1984	Young		8,834,329 B2 *	9/2014	Kelly	A63B 21/0783
D273,619 S	4/1984	Young					482/104
D273,711 S	5/1984	Young		8,876,672 B2 *	11/2014	Schiano	A63B 21/078
D273,997 S	5/1984	Ryan					482/94
D276,656 S	12/1984	Lindstrom		D718,883 S	12/2014	Thrush et al.	
4,527,797 A *	7/1985	Slade, Jr.	A63B 21/0626	D718,884 S *	12/2014	Thrush	D25/125
			482/101	8,992,395 B2	3/2015	Orakwusi	
D285,047 S *	8/1986	Dean	D8/349	9,011,298 B2	4/2015	Bonomi	
D290,033 S	5/1987	Policastro		9,044,629 B2	6/2015	Ross	
D297,957 S	10/1988	Gordon, III		D734,410 S	7/2015	Childs et al.	
4,934,693 A	6/1990	Santoro		D735,820 S	8/2015	Alenaddaf	
4,961,295 A	10/1990	Kosch, Sr. et al.		D735,821 S	8/2015	Alenaddaf	
5,046,722 A	9/1991	Antoon		D742,540 S	11/2015	Singh	
5,135,077 A	8/1992	Shalders		D742,543 S	11/2015	Singh	
5,184,992 A	2/1993	Banks		9,192,799 B2	11/2015	Alenaddaf	
5,273,506 A	12/1993	Dawson, Jr.		9,289,638 B2 *	3/2016	Towley, III	A63B 23/1218
D344,601 S	2/1994	Jenkins et al.		9,308,410 B2	4/2016	Beaver et al.	
5,290,209 A	3/1994	Wilkinson		D757,531 S	5/2016	Rusher	
5,306,220 A	4/1994	Kearney		9,333,387 B2 *	5/2016	Hopperstad	A63B 21/4035
D355,005 S	1/1995	Voothanel, Jr.		D764,607 S	8/2016	Beckford et al.	
D358,623 S	5/1995	Macasieb		9,409,048 B1	8/2016	Hopperstad et al.	
5,669,859 A	9/1997	Liggett et al.		9,427,611 B1	8/2016	Balentine	
5,776,033 A	7/1998	Brown		9,492,701 B1	11/2016	Bognatz	
D408,480 S	4/1999	Haugo		9,498,670 B1	11/2016	Hopperstad et al.	
6,116,550 A	9/2000	Forbes		9,517,382 B2	12/2016	Payne	
6,129,651 A	10/2000	Denaro		9,649,525 B2	5/2017	Hopperstad et al.	
6,220,988 B1	4/2001	Williams		9,675,829 B1	6/2017	Katz	
6,379,287 B1 *	4/2002	Slawinski	A63B 21/00181	9,700,761 B2	7/2017	Beaver et al.	
			482/104	D799,067 S	10/2017	Forsberg	
D484,617 S	12/2003	Micheals		D799,306 S	10/2017	Lee et al.	
D486,020 S	2/2004	Hoernig		D801,547 S	10/2017	Lopez	
D486,337 S	2/2004	Hoernig		D802,164 S	11/2017	Lopez	
D507,352 S	7/2005	Vanderbrugghen		9,844,691 B2	12/2017	Hopperstad et al.	
D514,857 S	2/2006	Hoernig		9,868,006 B1	1/2018	Epler	
D517,085 S	3/2006	Deuschle		D816,173 S	4/2018	Jackson	
D523,322 S	6/2006	Thurston et al.		D817,520 S	5/2018	Gonzales	
D525,668 S	7/2006	Payne		9,993,678 B2	6/2018	Hopperstad et al.	
D554,209 S	10/2007	Loucks		10,004,933 B2 *	6/2018	Lennox	A63B 21/22
7,316,379 B1	1/2008	Graham		10,086,226 B2 *	10/2018	Nelson	A63B 21/4035
7,374,516 B2	5/2008	Lundquist		D836,617 S	12/2018	Shu	
D582,569 S	12/2008	Moreau		10,226,661 B2	3/2019	Henniger et al.	
7,488,277 B1 *	2/2009	Knapp	A63B 21/078	D852,907 S	7/2019	Sergakis	
			482/104	D853,587 S	7/2019	Jackson et al.	
7,523,907 B2	4/2009	Chen		D853,588 S	7/2019	Jackson et al.	
D593,169 S	5/2009	Storch		D853,589 S	7/2019	Jackson et al.	
7,534,200 B1	5/2009	Martinez		D854,635 S	7/2019	Dunahay	
7,549,950 B1	6/2009	Lundquist et al.		D857,241 S	8/2019	Sakamoto et al.	
D596,761 S	7/2009	Beland		D858,721 S *	9/2019	Gori	D23/267
D613,883 S	4/2010	Staten et al.		10,471,293 B2 *	11/2019	George	A63B 23/0405
7,753,830 B1 *	7/2010	Marsh	A63B 23/03525	D869,688 S	12/2019	Lanzafame	
			482/142	D875,222 S *	2/2020	Gori	D23/267
7,892,158 B2	2/2011	Varga		D875,898 S *	2/2020	Gori	D23/267
D635,206 S	3/2011	Henniger		D879,216 S	3/2020	Dunahay	
D636,038 S	4/2011	Henniger		D879,217 S	3/2020	Dunahay	
D636,039 S	4/2011	Henniger		10,576,322 B2 *	3/2020	Schlegel	A63B 69/34
D636,040 S	4/2011	Henniger		D883,405 S	5/2020	Dunahay	
D639,585 S	6/2011	Shen et al.		10,646,740 B2 *	5/2020	Lee	A63B 21/156
D639,586 S	6/2011	Selinger et al.		D886,920 S	6/2020	Dunahay	
D639,587 S	6/2011	Selinger et al.		D888,851 S	6/2020	Dunahay	
8,047,972 B1	11/2011	Dean et al.		10,709,921 B2 *	7/2020	Risacher	A63B 17/04
8,079,915 B2	12/2011	Spencer et al.		D892,239 S *	8/2020	Carmichael	D21/694
8,083,191 B2	12/2011	Lai et al.		D898,137 S *	10/2020	Carmichael	D21/686
D659,854 S	5/2012	Kligman		10,806,963 B2 *	10/2020	Staten	A63B 21/4029
D660,984 S *	5/2012	Kotin	D25/119	D903,019 S *	11/2020	Sotis	D21/686
D661,412 S	6/2012	Kligman		10,864,401 B2 *	12/2020	Schween	A63B 1/00
8,206,270 B2	6/2012	Skipper		D906,740 S *	1/2021	Parab	D6/675.5
8,206,273 B2	6/2012	Skipper		D907,946 S *	1/2021	Parab	D6/675.5
8,323,158 B2	12/2012	Keiser		D909,192 S *	2/2021	Koelling	A47F 5/10
8,328,698 B1	12/2012	Webber et al.					D8/382
D682,955 S	5/2013	Stephan		D915,534 S *	4/2021	Adams	D21/694
8,500,608 B1	8/2013	Bonomi		D922,809 S *	6/2021	Parab	D6/675.5
8,517,900 B1	8/2013	Britt		D928,253 S *	8/2021	Dunahay	D21/686
D703,773 S	4/2014	Henry		11,103,739 B2 *	8/2021	Shaw, Jr.	A63B 21/0726
D711,021 S	8/2014	Singh		11,123,595 B2 *	9/2021	Henniger	A63B 21/169
				2001/0034289 A1	10/2001	Parrillo	
				2002/0082145 A1	6/2002	Hamilton	
				2002/0123415 A1	9/2002	Marques	
				2003/0222041 A1	12/2003	Hong et al.	
				2005/0130806 A1	6/2005	Lopez	

(56)

References Cited

U.S. PATENT DOCUMENTS

2005/0250619 A1 11/2005 Daikeler et al.
 2006/0003875 A1 1/2006 Sharps
 2006/0065800 A1 3/2006 Bremmon
 2006/0145038 A1 7/2006 Chen
 2007/0072750 A1 3/2007 Andrews
 2007/0203002 A1 8/2007 Webber
 2009/0105052 A1 4/2009 Dalebout et al.
 2009/0124471 A1 5/2009 Storch
 2010/0044536 A1 2/2010 Huang
 2010/0048368 A1 2/2010 Donofrio
 2010/0171017 A1 7/2010 Chang
 2011/0245040 A1 10/2011 Skipper
 2011/0248128 A1 10/2011 Oh
 2012/0046150 A1 2/2012 Stacey
 2012/0094812 A1 4/2012 Smiley
 2012/0115683 A1 5/2012 Ross
 2012/0329614 A1 12/2012 Schiano
 2013/0178338 A1 7/2013 Ross
 2013/0184124 A1 7/2013 Reed
 2013/0237394 A1 9/2013 Fowler
 2013/0260970 A1 10/2013 Moskowich
 2013/0296143 A1 11/2013 Staten et al.
 2014/0094347 A1 4/2014 Orakwusi
 2014/0166834 A1 6/2014 Kuroyanagi et al.
 2014/0221163 A1 8/2014 McBride et al.
 2014/0256517 A1 9/2014 Poppinga
 2014/0302968 A1 10/2014 Velikin et al.
 2014/0371040 A1 12/2014 Vasquez et al.
 2015/0016919 A1 1/2015 Tambornino et al.
 2015/0059257 A1 3/2015 Beaver et al.
 2015/0065316 A1 3/2015 Towley, III et al.
 2015/0069257 A1 3/2015 Besson
 2015/0076092 A1 3/2015 Tambornino et al.
 2015/0126335 A1 5/2015 Gilson et al.
 2015/0148197 A1 5/2015 Lentz et al.
 2015/0202485 A1 7/2015 Towley, III et al.
 2015/0264823 A1 9/2015 Shirley et al.
 2015/0290488 A1 10/2015 Hopperstad et al.
 2016/0023035 A1 1/2016 Meyer
 2016/0250515 A1 9/2016 Hopperstad et al.
 2016/0338512 A1 11/2016 Royak
 2016/0339291 A1 11/2016 Hopperstad et al.
 2017/0065844 A1 3/2017 Hopperstad et al.
 2017/0072260 A1 3/2017 Jackson
 2017/0150786 A1 6/2017 Ness et al.
 2017/0189736 A1 7/2017 Martin
 2017/0209733 A1 7/2017 Beaver et al.
 2017/0239512 A1 8/2017 Brasch et al.
 2017/0246490 A1 8/2017 Hopperstad et al.
 2017/0246496 A1 8/2017 Nelson et al.
 2017/0259101 A1 9/2017 Im
 2018/0028852 A1 2/2018 Beaver et al.
 2018/0036573 A1 2/2018 Lennox et al.
 2018/0056108 A1 3/2018 Kelly
 2018/0056116 A1 3/2018 Le Nguyen
 2018/0104522 A1 4/2018 Hopperstad et al.
 2018/0117382 A1 5/2018 Johanson et al.
 2018/0140922 A1 5/2018 Greer
 2018/0142832 A1 5/2018 Inouye
 2018/0153305 A1 6/2018 Haines
 2018/0154234 A1 6/2018 Pack et al.
 2018/0178051 A1 6/2018 Shaw, Jr.
 2018/0185694 A1 7/2018 Schween
 2018/0243597 A1 8/2018 Schlegel
 2018/0318635 A1 11/2018 Lee
 2018/0326250 A1* 11/2018 Henniger A63B 23/1218
 2019/0046835 A1 2/2019 Henniger et al.
 2019/0126088 A1 5/2019 Henniger et al.
 2019/0240521 A1 8/2019 Staten
 2019/0269992 A1 9/2019 Dunahay
 2020/0114195 A1* 4/2020 Henniger A63B 21/0552
 2020/0384337 A1* 12/2020 Brasch A63B 21/078
 2020/0391070 A1* 12/2020 Henniger A47B 81/00
 2021/0070368 A1 3/2021 Toda et al.
 2021/0213321 A1* 7/2021 Silveira A63B 21/0724

FOREIGN PATENT DOCUMENTS

WO 2008054720 A2 5/2008
 WO 2009003280 A1 1/2009

OTHER PUBLICATIONS

Screenshot of Abt Electronics wall mount from <https://www.youtube.com/watch?v=XJEmJhEleH0>, dated Jun. 6, 2013, accessed Jun. 2, 2020.
 Screenshot of Show Me CABLES ultra slim tv wall mount from <https://www.youtube.com/watch?v=UfcsWN7brCg>, dated Jun. 27, 2016, accessed Jun. 2, 2020.
 Screenshot of Texonic Model LX67 wall mount from <https://www.youtube.com/watch?v=ojTXO9edjEc>, dated Jul. 5, 2017, accessed Jun. 2, 2020.
 Screenshot of Sony SUWL450 wall mount from https://www.amazon.co.uk/Sony-SUWL450-Wall-Mount/dp/B001ZEIZB4/ref=sr_1_20?keywords=Sony+Wall+Mount+Bracket&qid=1580915273&sr%2E%80%A6, dated Mar. 14, 2014.
 Screenshot of Sony Duronic TV Bracket TV123M wall mount from https://www.amazon.co.uk/dp/B001PHBZFQ/ref=psdc_1338216031_t4_B07MX3Q3NZ, dated Jan. 12, 2009.
 Screenshot of wall mounting bracket Dv5 from Hornung's Industrial Gas Catalogue, <http://my.page2flip.de/1672972/2178732/2178865/pdf/CatalogueforindustrialgascontrolequipmentHornungGmbH.pdf>, dated Jan. 2013.
 Screenshot of wall mounting bracket D2 from Hornung's Industrial Gas Catalogue, <http://my.page2flip.de/1672972/2178732/2178865/pdf/CatalogueforindustrialgascontrolequipmentHornungGmbH.pdf>, dated Jan. 2013, accessed Feb. 6, 2020.
 Screenshot of wall mounting bracket painted from Hornung's Industrial Gas Catalogue, <http://my.page2flip.de/1672972/2178732/2178865/pdf/CatalogueforindustrialgascontrolequipmentHornungGmbH.pdf>, dated Jan. 2013, accessed Feb. 6, 2020.
 Screenshot of wall mounting bracket in stainless steel electropolishing from Hornung's Industrial Gas Catalogue, <http://my.page2flip.de/1672972/2178732/2178865/pdf/CatalogueforindustrialgascontrolequipmentHomungGmbH.pdf>, dated Jan. 2013, accessed Feb. 6, 2020.
 Screenshot of wall mounting bracket in stainless steel, electropolishing, HP 550-552 from Hornung's Industrial Gas Catalogue, <http://my.page2flip.de/1672972/2178732/2178865/pdf/CatalogueforindustrialgascontrolequipmentHornungGmbH.pdf>, dated Jan. 2013, accessed Feb. 6, 2020.
 Screenshot of Altecnic Expansion Vessel Bracket from https://www.amazon.co.uk/dp/B00QVM4LCE/ref=sspa_dk_detail_0?psc=1&pd_rd_i=B00QVM4LCE&pd_rd_w=6dXas&pf_rd_p=1055d8b2-c10c-4%E2%80%A6, dated Dec. 11, 2014, accessed Feb. 5, 2020.
 Screenshot of Reflex Winkelmann Wall Holder from <https://www.amazon.co.uk/Reflex-Winkelmann-7611000-Holder-25-Litre/dp/B0017UWL6l>, dated Dec. 13, 2012, accessed Feb. 5, 2020.
 Design View Registered Community Design No. 002104463-0001, dated Sep. 17, 2012.
 Design View Registered Community Design No. 00765862-0001, dated Jul. 27, 2007.
 Design View Registered Community Design No. 000153796-0002, dated Feb. 25, 2004.
 Screenshot of Mammoth Lite Folding Rack from BULLDOG Gear Instagram account, dated Jan. 11, 2018.
 Screenshot of Folding Rack from Bulldog Gear Instagram account, dated Oct. 2, 2018.
 Screenshot of wall bracket from Weinmann-Schanz, <http://web.archive.org/web/20170909025230/http://www.weinmann-schanz.de/de/Heizung/Neu-im-Sortiment/W%C3%A4rmeerzeuger-Speicher/pid.1143.1160/agid.90421.90432.105367/ecm.ag/Abstandsmontageplatten-f%C3%BCr-Wandkonsolen.html>, dated Sep. 9, 2017.
 Screenshot of wall bracket from Weinmann-Schanz, <https://www.weinmann-schanz.de/de/Heizung/W%C3%A4rmeerzeuger-Speicher/Abgassysteme/Edelstahl-Abgassystem-Uni-DW->

(56)

References Cited

OTHER PUBLICATIONS

doppelwandig/Abstandsmontageplatten-f%C3%BCr-Wandkonsolen-sid134351.htm, accessed Feb. 6, 2020.

Screenshot of wall bracket from Weinmann-Schanz, <http://web.archive.org/web/20170529161506/http://www.weinmann-schanz.de:80/de/de/Heizung/Neu-im-Sortiment/W%C3%A4rmeerzeuger-Speicher/pid.1143.1160/agid.90421.90432.105379/ecm.ag/Abstandsmontageplatten-f%C3%BCr-Wandhalter.html>, dated May 29, 2017.

Screenshot of wall bracket from Weinmann-Schanz, <https://www.weinmann-schanz.de/de/de/Heizung/W%C3%A4rmeerzeuger-Speicher/Abgassysteme/Edelstahl-Abgassystem-Uni-DW-doppelwandig/Abstandsmontageplatten-f%C3%BCr-Wandhalter-sid182096.html>, accessed Feb. 11, 2020.

Coulter Ventures LLC v Bulldog Gear Limited, UK High Court (Eng. & Wales), Claim No. HP-2019-000054, Defence and Counterclaim, dated Feb. 13, 2020.

Coulter Ventures LLC v Bulldog Gear Limited, High Court (Eng. & Wales), Claim No. HP-2019-000054, Defendant's Initial Disclosure List of Documents, dated Feb. 12, 2020.

Coulter Ventures LLC v Bulldog Gear Limited, High Court (Eng. & Wales), Claim No. HP-2019-000054, Amended Defence and Counterclaim, dated Apr. 23, 2020.

Coulter Ventures LLC v Bulldog Gear Limited, High Court (Eng. & Wales), Claim No. HP-2019-000054, Amended Defendant's Initial Disclosure List of Documents, dated Apr. 23, 2020.

Coulter Ventures LLC v Bulldog Gear Limited, High Court (Eng. & Wales), Claim No. HP-2019-000054, Re-Amended Defence and Counterclaim, dated Feb. 4, 2021.

Coulter Ventures LLC v Bulldog Gear Limited, High Court (Eng. & Wales), Claim No. HP-2019-000054, Claim Form and Particulars of Claim, dated Dec. 18, 2019.

Coulter Ventures LLC v Bulldog Gear Limited, High Court (Eng. & Wales), Claim No. HP-2019-000054, Claimant's Initial Disclosure List of Documents, dated Dec. 18, 2019.

Coulter Ventures LLC v Bulldog Gear Limited, High Court (Eng. & Wales), Claim No. HP-2019-000054, Reply and Defence to Counterclaim, dated Apr. 2, 2020.

Coulter Ventures LLC v Bulldog Gear Limited, High Court (Eng. & Wales), Claim No. HP-2019-000054, Amended Reply and Defence to Counterclaim, dated Feb. 18, 2021.

Coulter Ventures LLC v Bulldog Gear Limited, High Court (Eng. & Wales), Claim No. HP-2019-000054, Amended Claim Form and Amended Particulars of Claim, dated Dec. 23, 2020.

Rogue product advertisement dated Dec. 3, 2015 (redacted).

Rogue fitness product video screenshots from <<https://www.youtube.com/watch?v=TRpmZ68p5Hw>>, dated Sep. 19, 2017.

Gorilla Fitness product advertisement dated Apr. 16, 2018 (redacted).

Bulldog Gear product advertisement dated Jan. 11, 2018.

Pure Strength product listing dated Sep. 6, 2018 from <<https://www.pure-strength.com/collections/slim-gym-utility-plate>>.

Titan Fitness product listing dated Sep. 6, 2018 from <<https://www.titan.fitness/t-3-folding-power-rack-stringers.html>>.

Titan Fitness product listing dated Sep. 6, 2018 from <<https://www.titan.fitness/41-inch-deep-folding-wall-mount-rack.html>> (product known to be available as of Mar. 2, 2016).

Product listing for Rogue V2 Face Mount Pull-up Bar for Monster Lite from <https://web.archive.org/web/20161105161238/https://www.roguefitness.com/rogue-v2-face-mount-pull-up-bar-for-monster-lite>, dated Nov. 5, 2016.

Jan. 11, 2019—(WO) ISR and WO—App No. PCT/US2018/059018.

Dec. 14, 2021—(CN) 4th Office Action—App 201880085010.6.

* cited by examiner

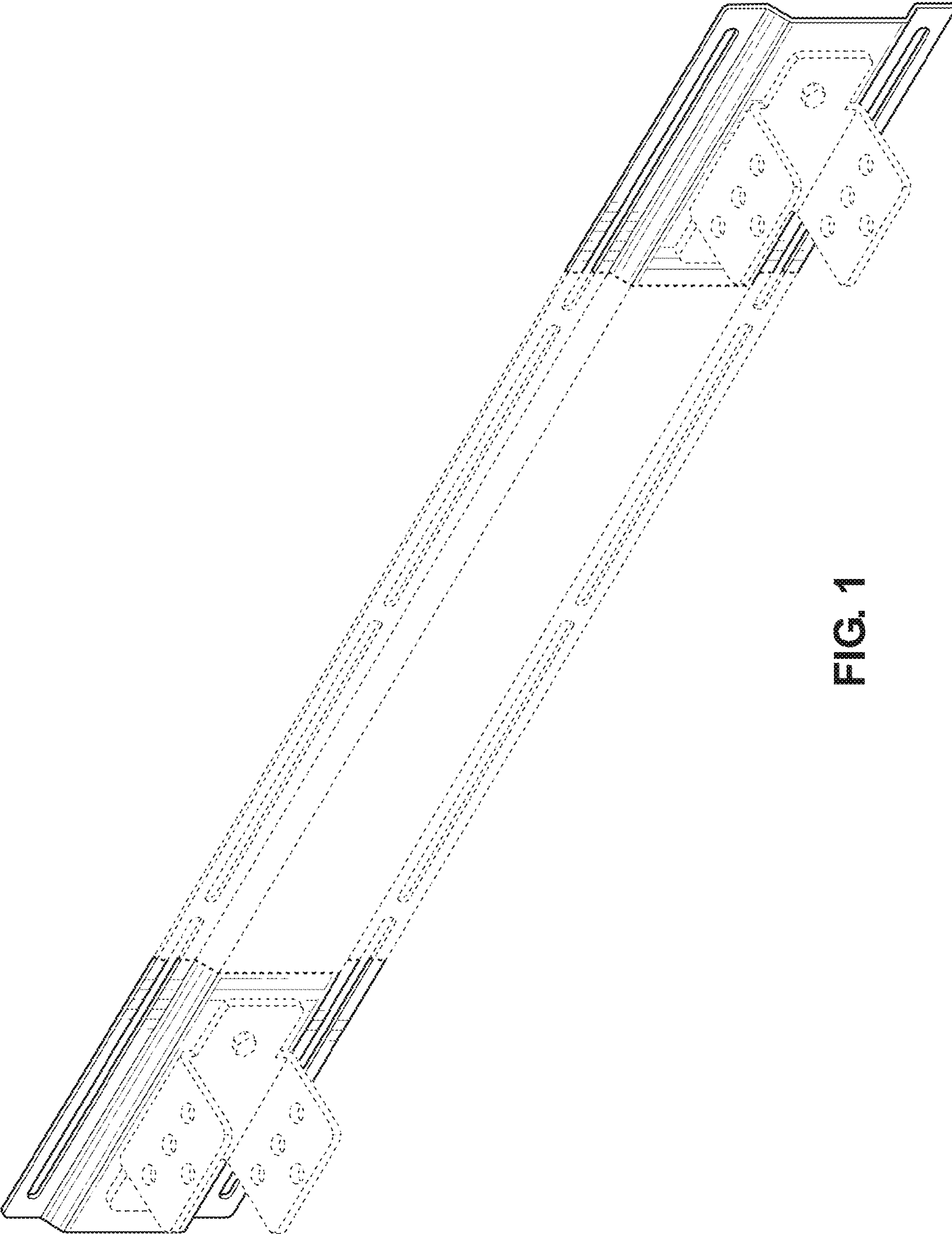

FIG. 1

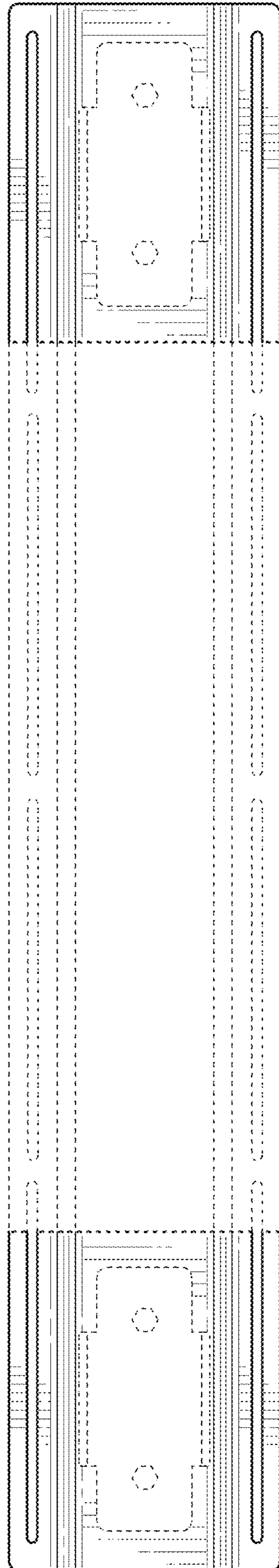

FIG. 2

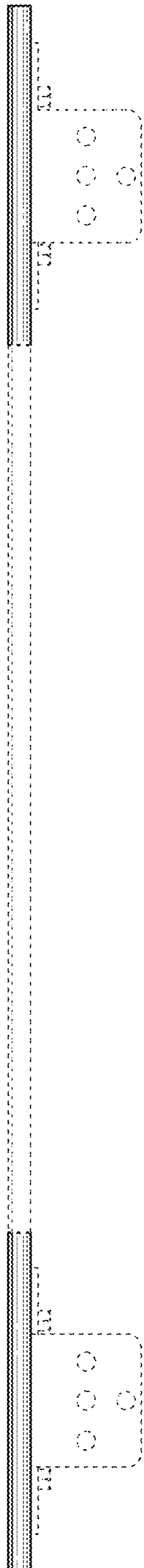

FIG. 3

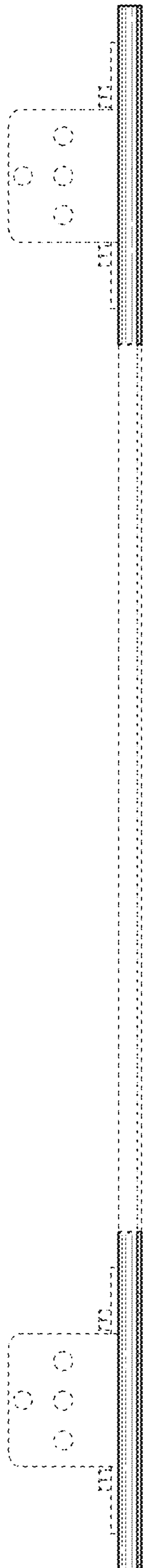

FIG. 4

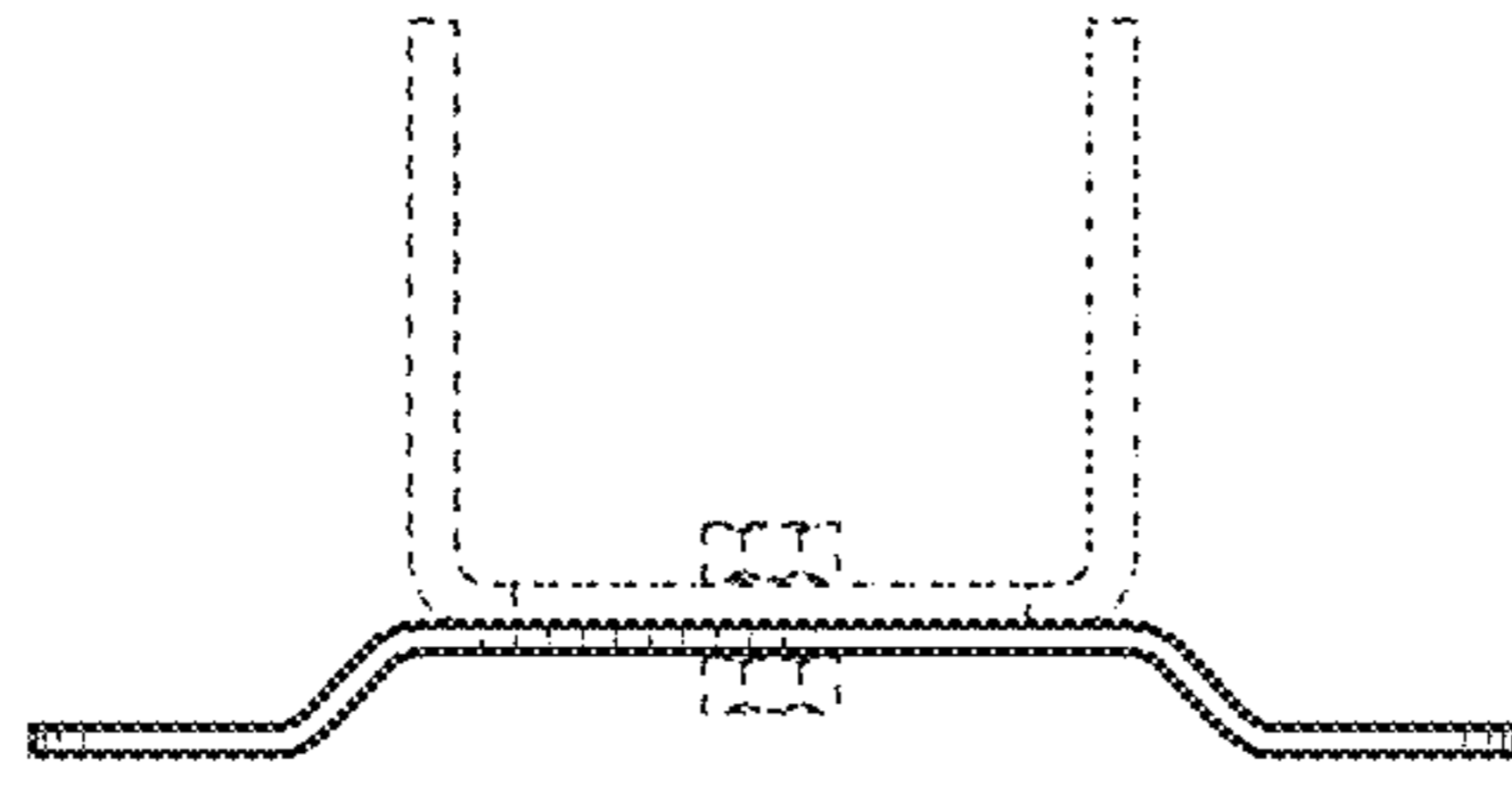

FIG. 6

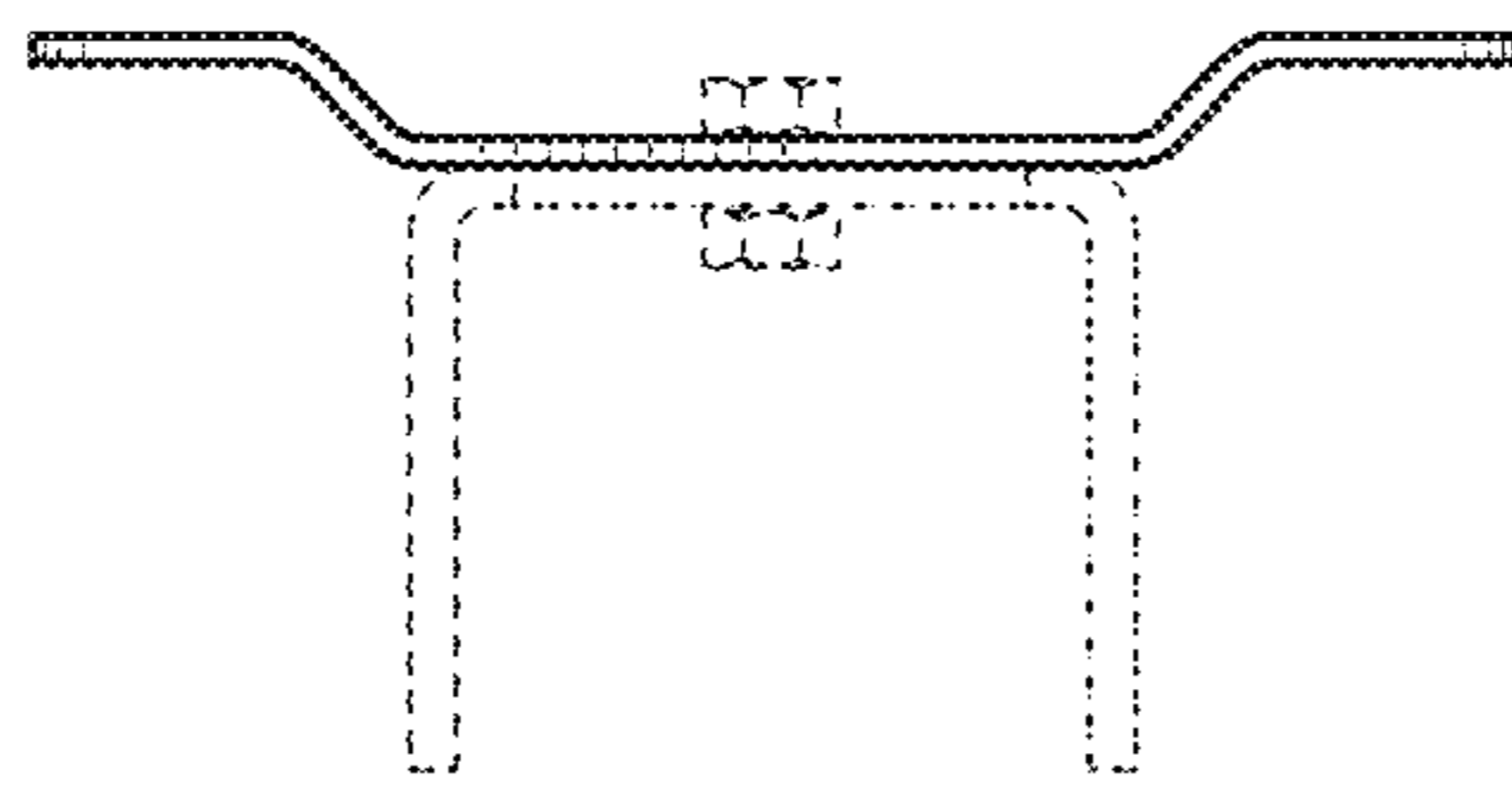

FIG. 5