



US00D949227S

(12) **United States Design Patent**
Tang

(10) **Patent No.:** **US D949,227 S**

(45) **Date of Patent:** **** Apr. 19, 2022**

(54) **CAMERA**

(71) Applicant: **Dengfeng Tang**, Chengdu (CN)

(72) Inventor: **Dengfeng Tang**, Chengdu (CN)

(**) Term: **15 Years**

(21) Appl. No.: **29/783,511**

(22) Filed: **May 13, 2021**

(51) **LOC (13) Cl.** **16-01**

(52) **U.S. Cl.**
USPC **D16/218**

(58) **Field of Classification Search**
USPC D16/200, 202–205, 208, 218, 219;
348/14.01–14.6, 143, 146, 148, 208.11,
348/373–376; 396/427, 535, 539–541
CPC G03B 17/02; G03B 19/04; G03B 17/56;
G03B 17/04; G03B 15/03; H04N 5/2251;
H04N 5/2252; H04N 5/2253; H04N
5/2254; H04N 5/23248; H04N 2007/145;
H04N 7/141; H04N 7/142; H04N 7/147;
H04N 7/148; H04N 7/15; H04N 7/152
See application file for complete search history.

(56) **References Cited**

U.S. PATENT DOCUMENTS

D455,767 S	*	4/2002	Tsang	D16/202
D563,446 S	*	3/2008	Stephens	D16/202
D574,099 S	*	7/2008	Leen	D26/60
D727,387 S	*	4/2015	Hasegawa	D16/203
D728,660 S	*	5/2015	Kim	D16/219
D730,423 S	*	5/2015	Vandenbussche	D16/218

D732,613 S	*	6/2015	Davies, III	D21/680
D743,475 S		11/2015	Cover		
D745,589 S	*	12/2015	Lee	D16/218
D745,916 S	*	12/2015	Oh	D16/219
D762,759 S	*	8/2016	Wu	D16/218
D776,180 S	*	1/2017	Fiedler	D16/202
D791,851 S		7/2017	Zhang		
D826,206 S	*	8/2018	Elmieh	D14/204
D849,080 S	*	5/2019	Rosenberg	D16/202

* cited by examiner

Primary Examiner — Ramzi Almatrahi

(57) **CLAIM**

The ornamental design for a camera, as shown and described.

DESCRIPTION

FIG. 1 is a top, front and right side perspective view of a camera showing my design;
FIG. 2 is a front elevation view thereof;
FIG. 3 is a back elevation view thereof;
FIG. 4 is a left side elevation view thereof;
FIG. 5 is a right side elevation view thereof;
FIG. 6 is a top plan view thereof;
FIG. 7 is a bottom plan view thereof; and,
FIG. 8 is a bottom, back and left side perspective view thereof.

The broken lines depict portions of the camera in which the design is embodied that form no part of the claimed design.

1 Claim, 8 Drawing Sheets

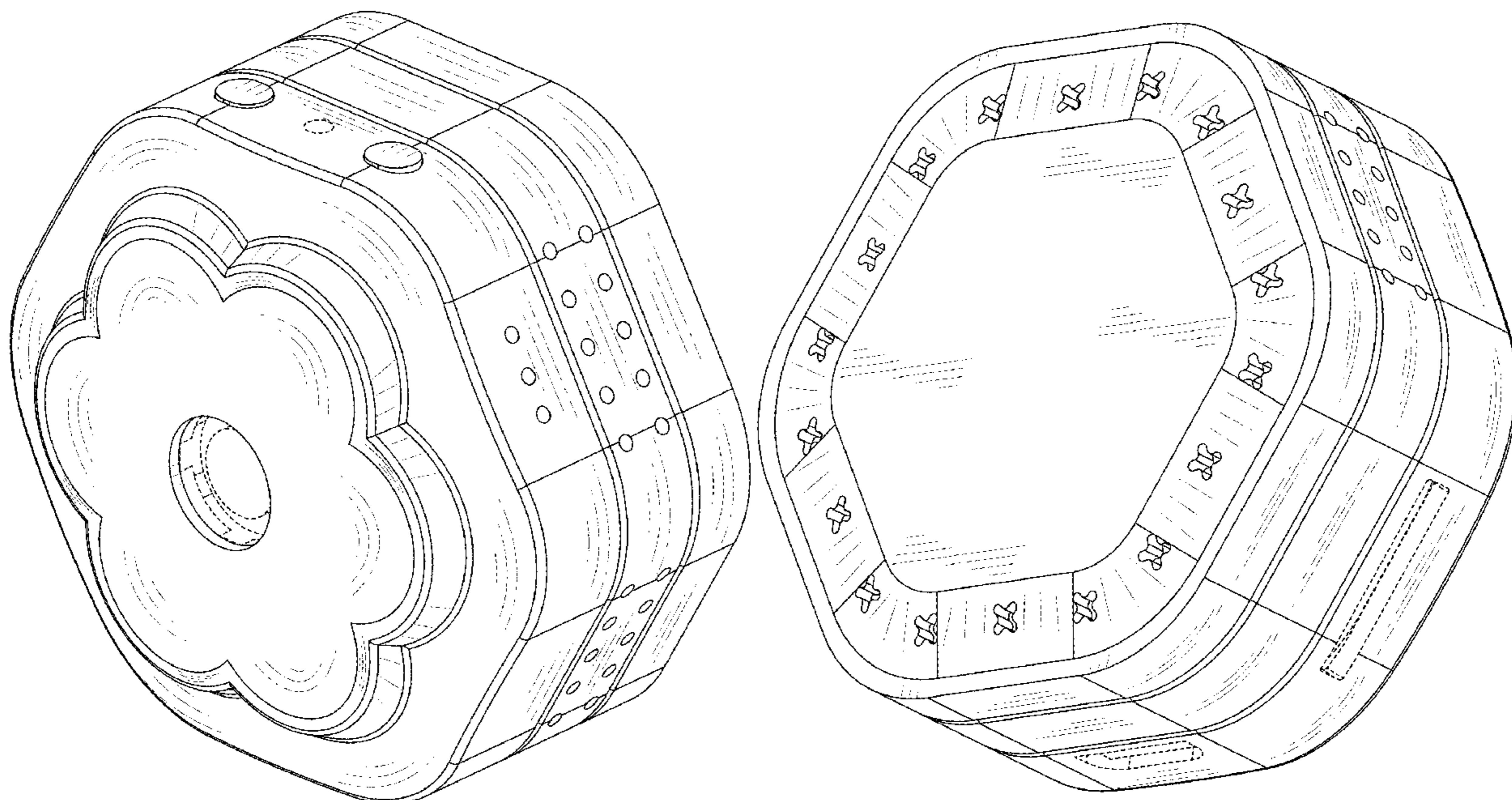

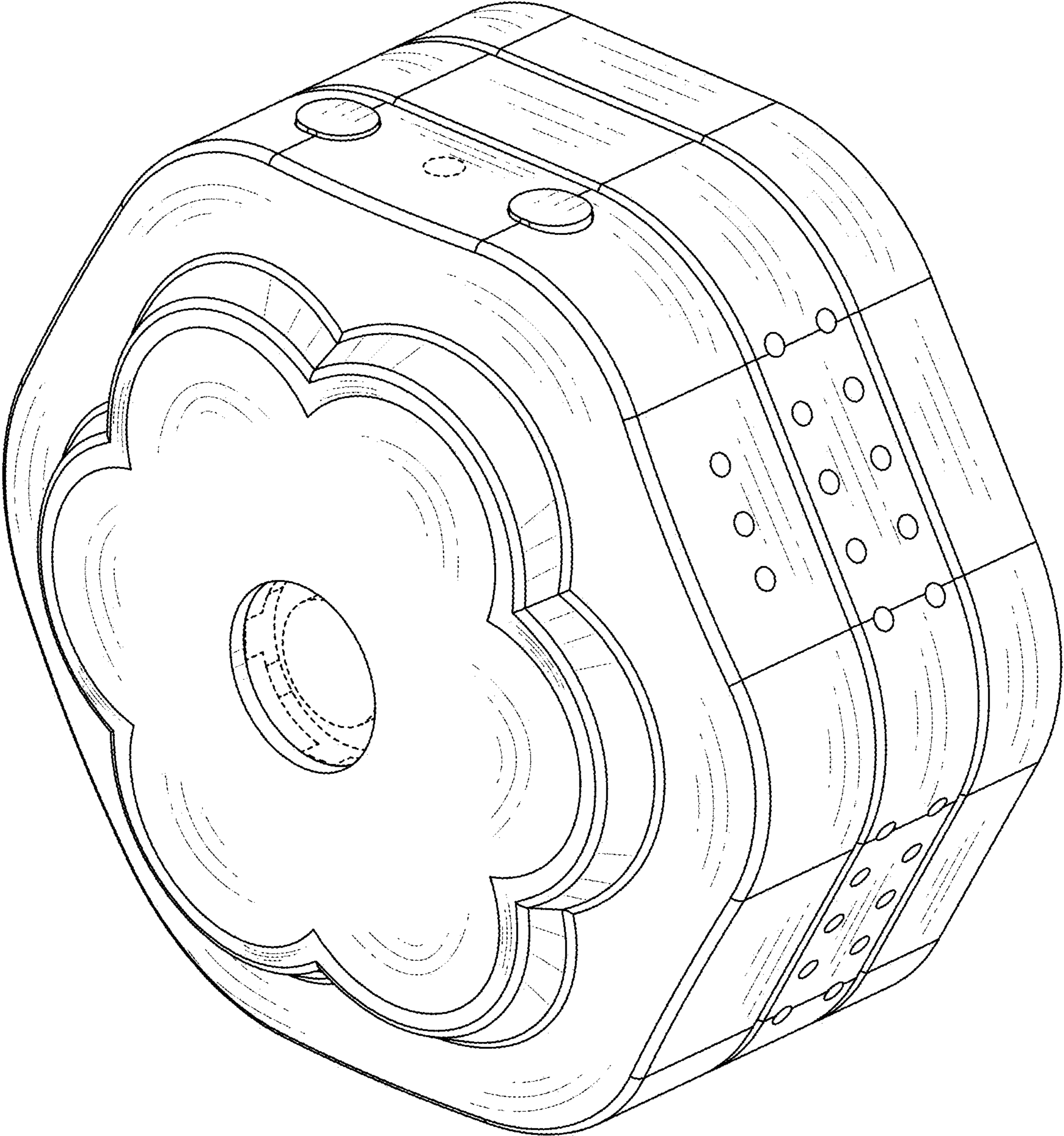

FIG. 1

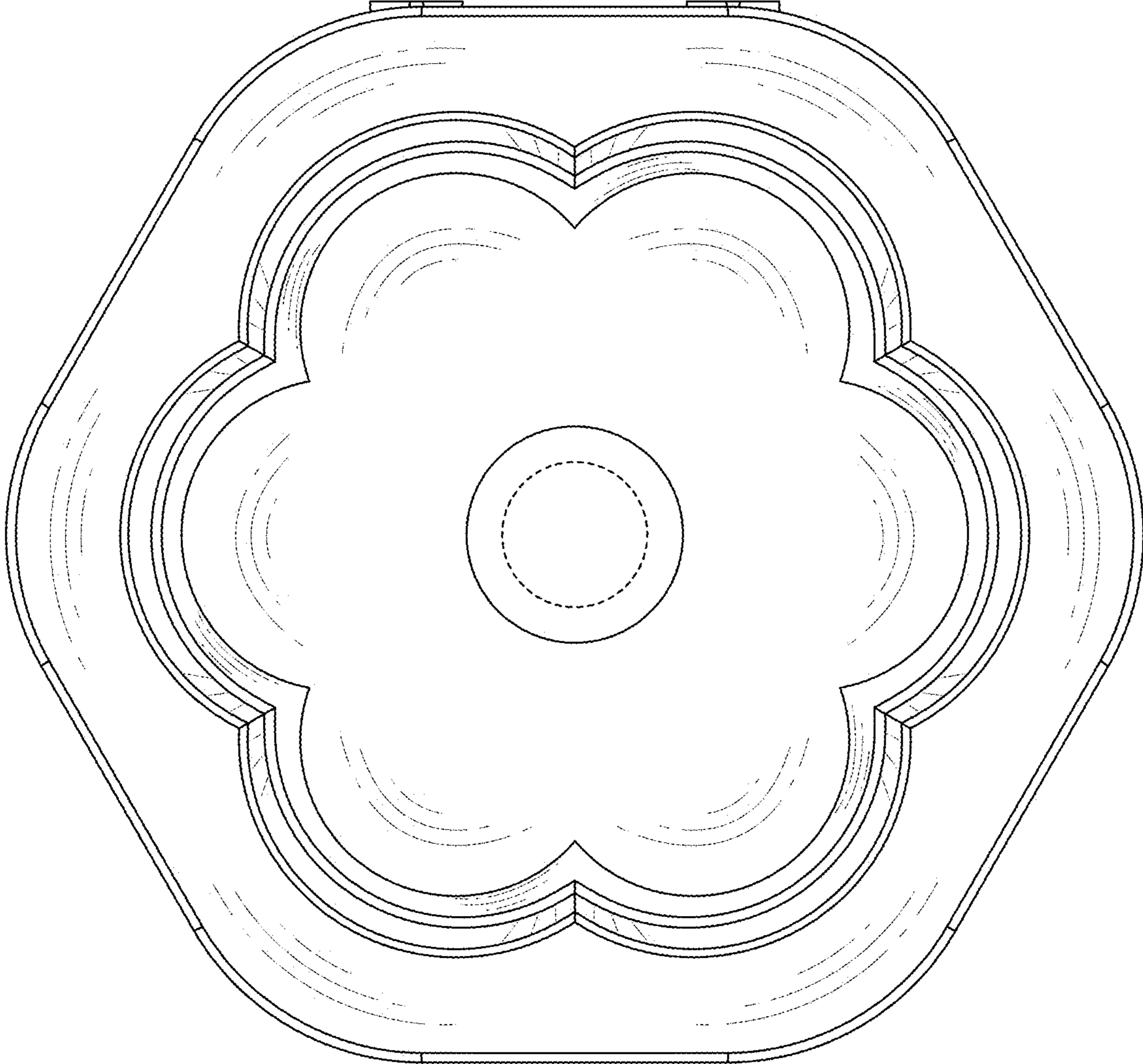

FIG. 2

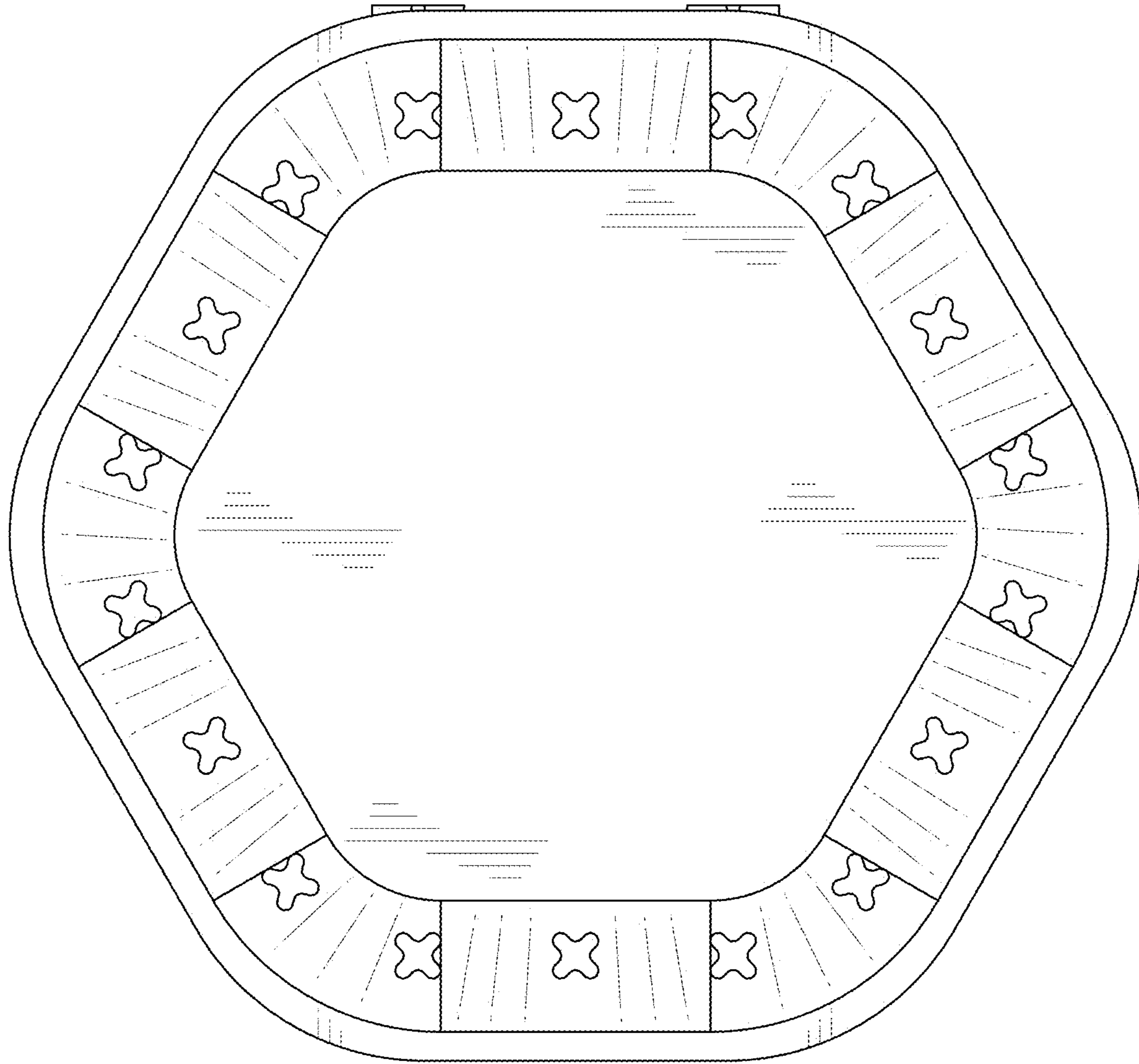

FIG. 3

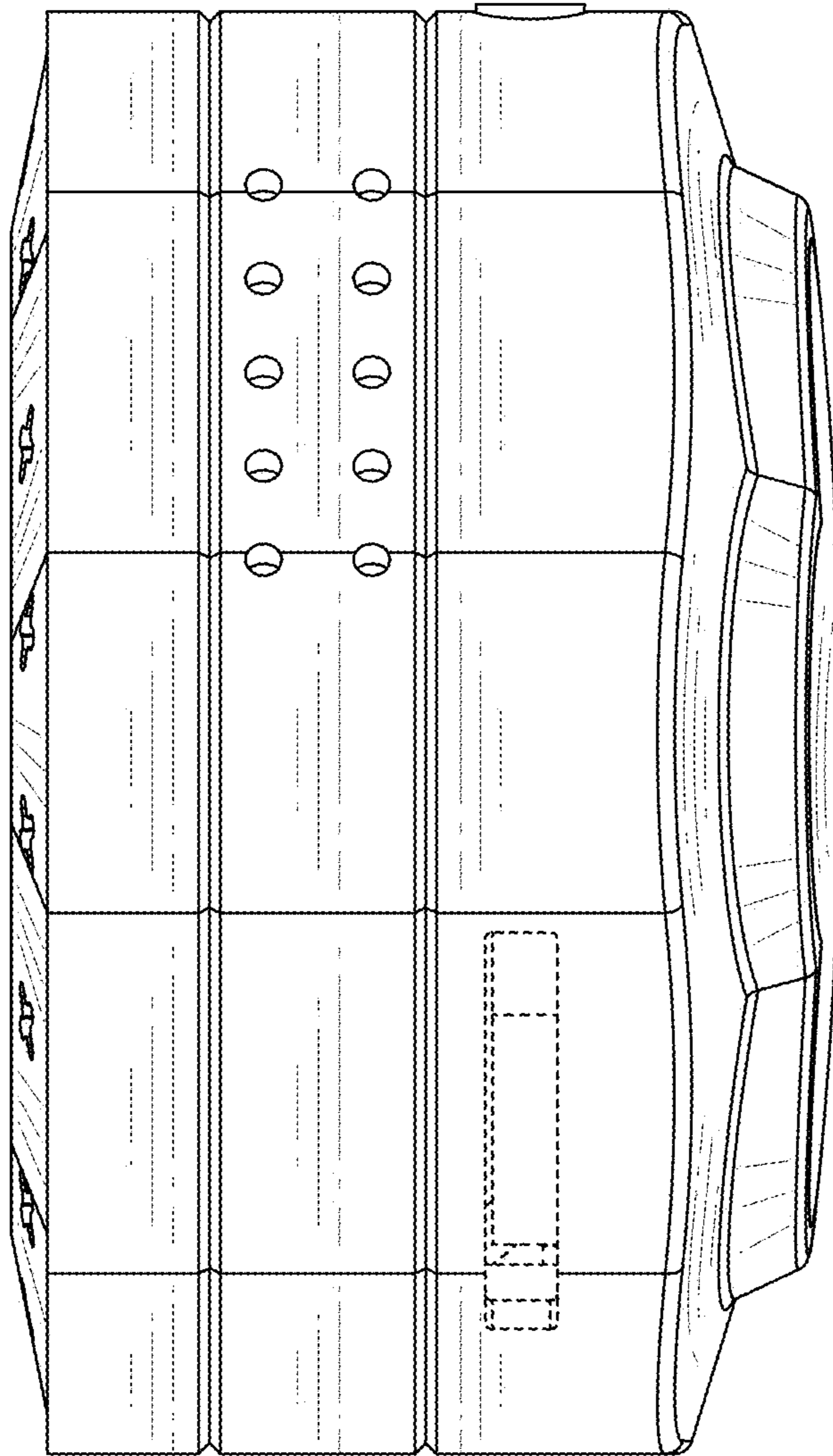

FIG. 4

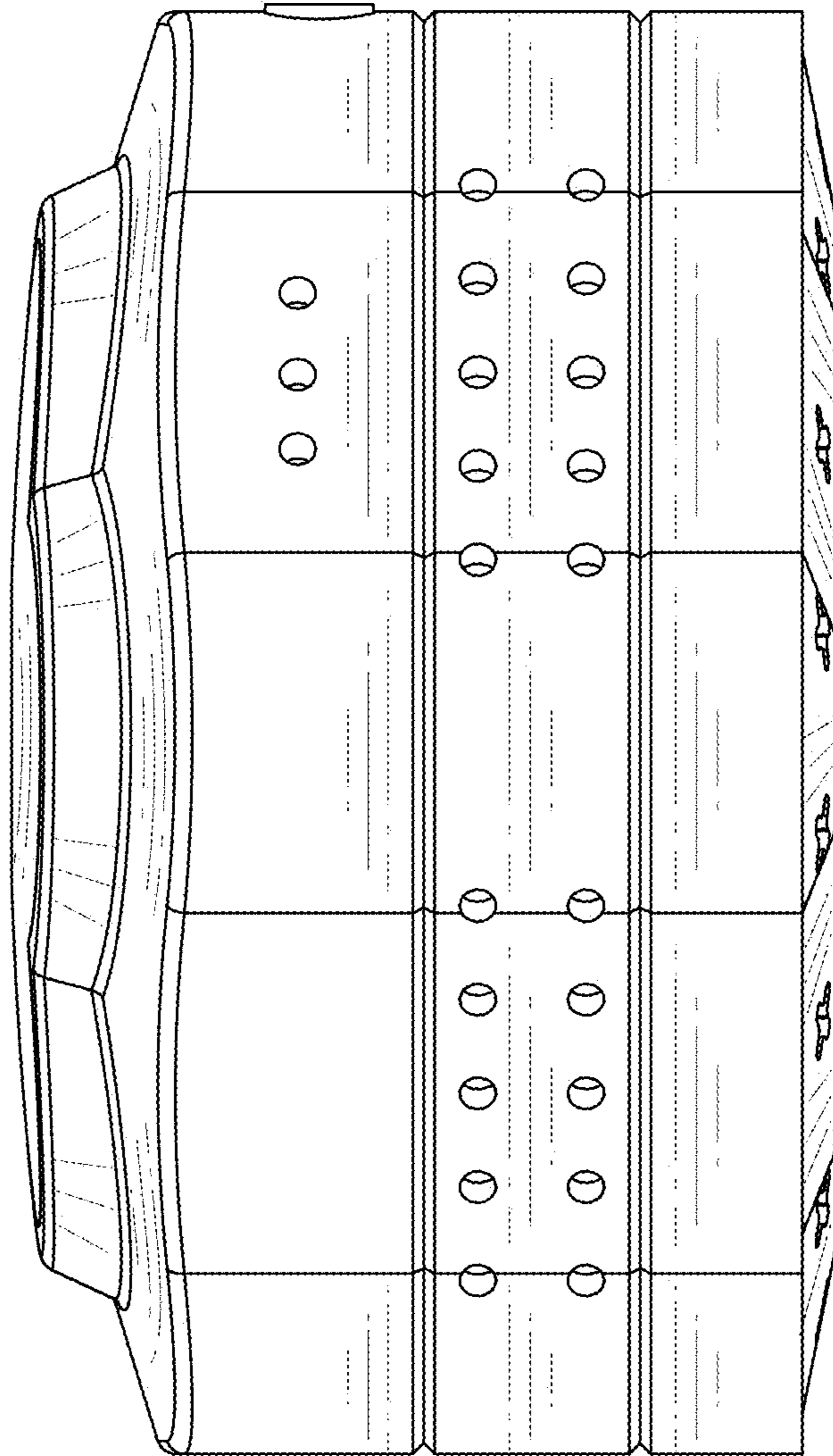

FIG. 5

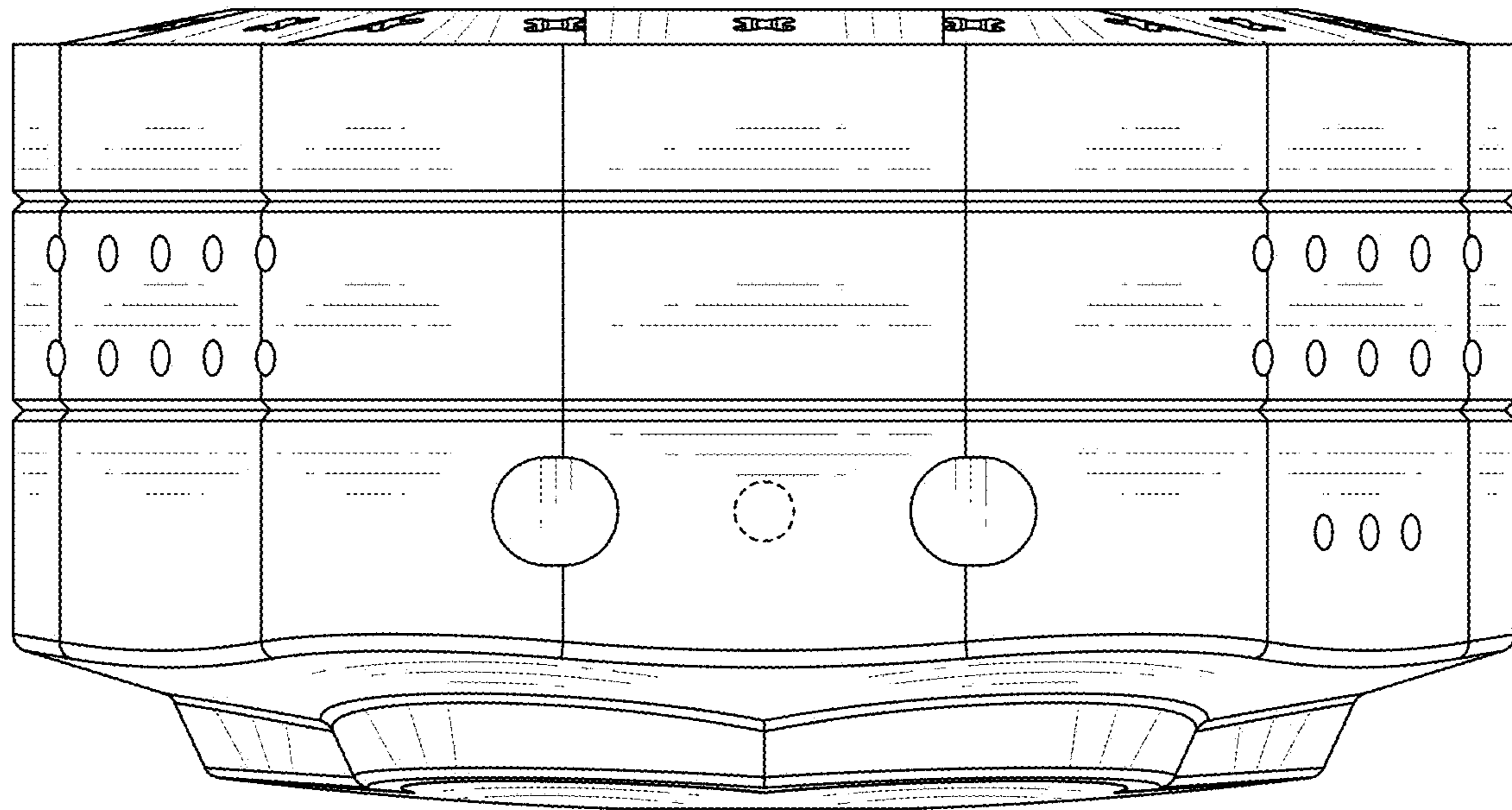

FIG. 6

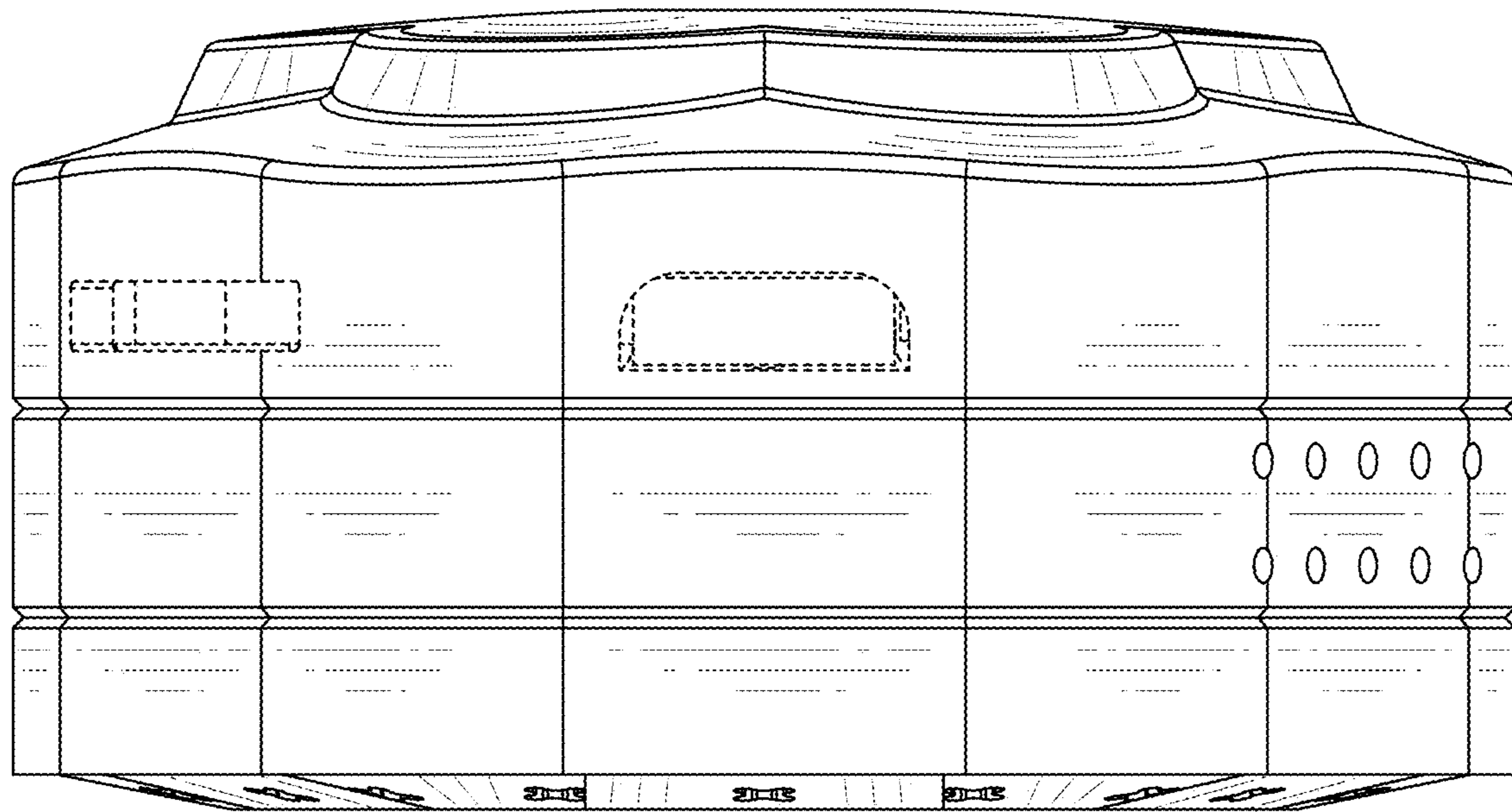

FIG. 7

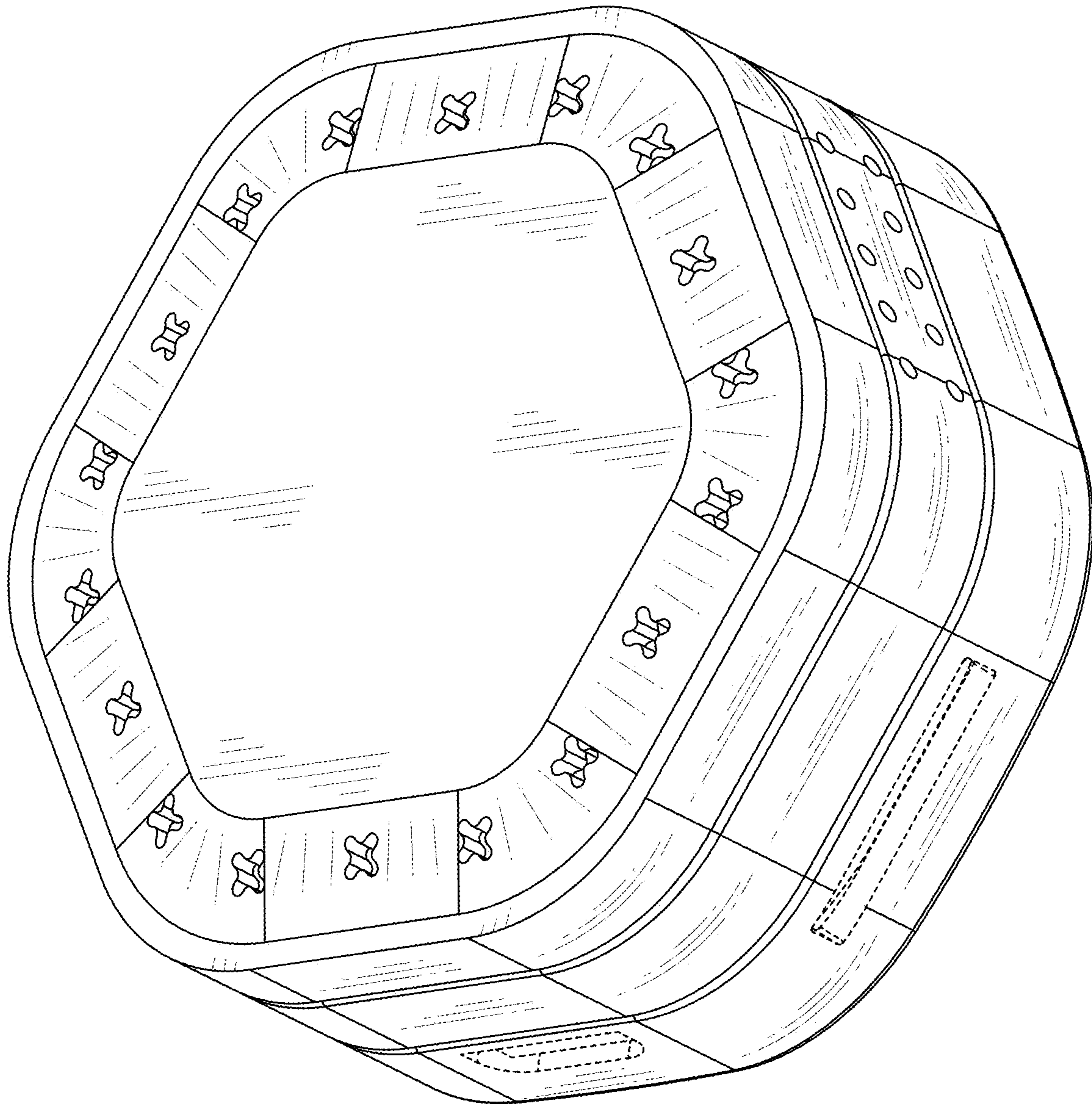

FIG. 8