



US00D949111S

(12) **United States Design Patent**
Ning

(10) **Patent No.:** **US D949,111 S**

(45) **Date of Patent:** **** Apr. 19, 2022**

(54) **CAR CHARGER**

(71) Applicant: **Jing Ning**, Shenzhen (CN)

(72) Inventor: **Jing Ning**, Shenzhen (CN)

(**) Term: **15 Years**

(21) Appl. No.: **29/746,814**

(22) Filed: **Aug. 18, 2020**

(51) **LOC (13) Cl.** **13-03**

(52) **U.S. Cl.**
USPC **D13/144**

(58) **Field of Classification Search**
USPC D13/144, 108, 110, 107, 103; D12/114;
D14/155, 252; D27/141
CPC H02J 7/342; H01R 2201/26
See application file for complete search history.

(56) **References Cited**

U.S. PATENT DOCUMENTS

5,599,204	A	*	2/1997	Glassford	H01R 31/06 439/502
D632,653	S	*	2/2011	Wikel	D13/144
D632,817	S	*	2/2011	Wang	D26/49
D654,027	S	*	2/2012	Huang	D13/144
D720,296	S	*	12/2014	Charnis	D13/144
D928,094	S	*	8/2021	Chen	D12/114
D939,448	S	*	12/2021	Li	D13/144

OTHER PUBLICATIONS

Amazon.com. Ailkin 30W PD USB C Car Charger. Date published: Jan. 2021; Date accessed: Feb. 2022. <https://www.amazon.com/AILKIN-Charger-Charging-Cargador-Lighter/dp/B08S333KDC?th=1> (Year: 2021).*

* cited by examiner

Primary Examiner — Jennifer O King

(57) **CLAIM**

The ornamental design for a car charger, as shown and described.

DESCRIPTION

FIG. 1 is a front and top perspective view of a car charger, showing my new design;
FIG. 2 is a rear and top perspective view thereof;
FIG. 3 is a front elevational view thereof;
FIG. 4 is a rear elevational view thereof;
FIG. 5 is a left side elevational view thereof;
FIG. 6 is a right side elevational view thereof;
FIG. 7 is a top plan view thereof; and,
FIG. 8 is a bottom plan view thereof.
The broken lines in the figures illustrate portions of the car charger that form no part of the claimed design.

1 Claim, 8 Drawing Sheets

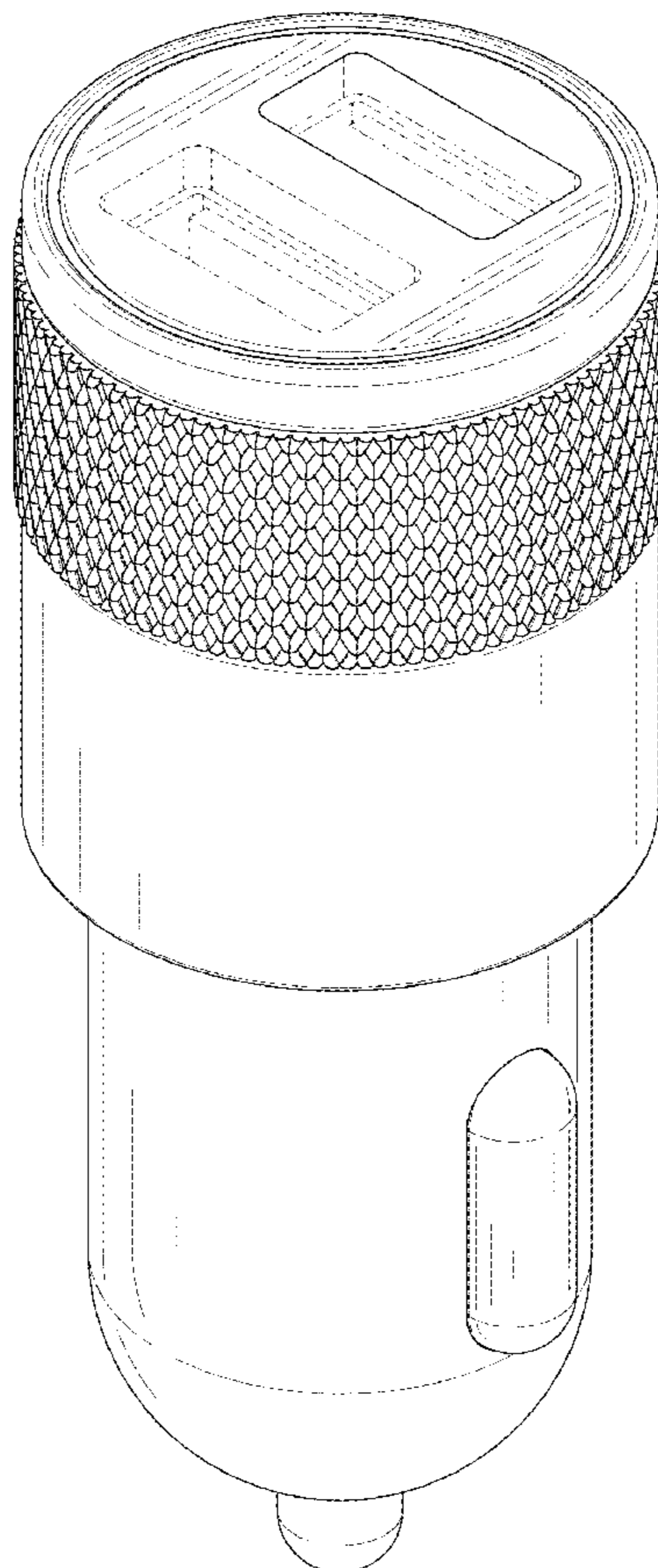

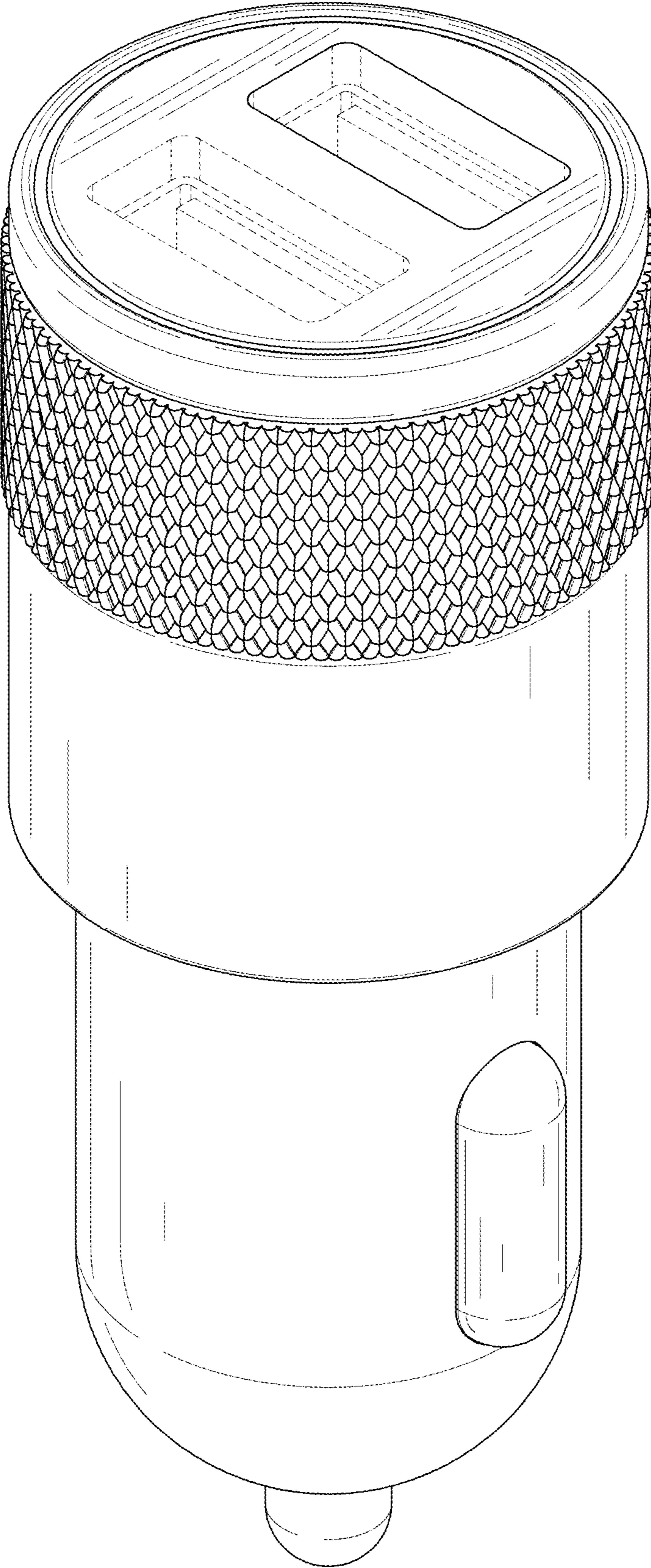

FIG. 1

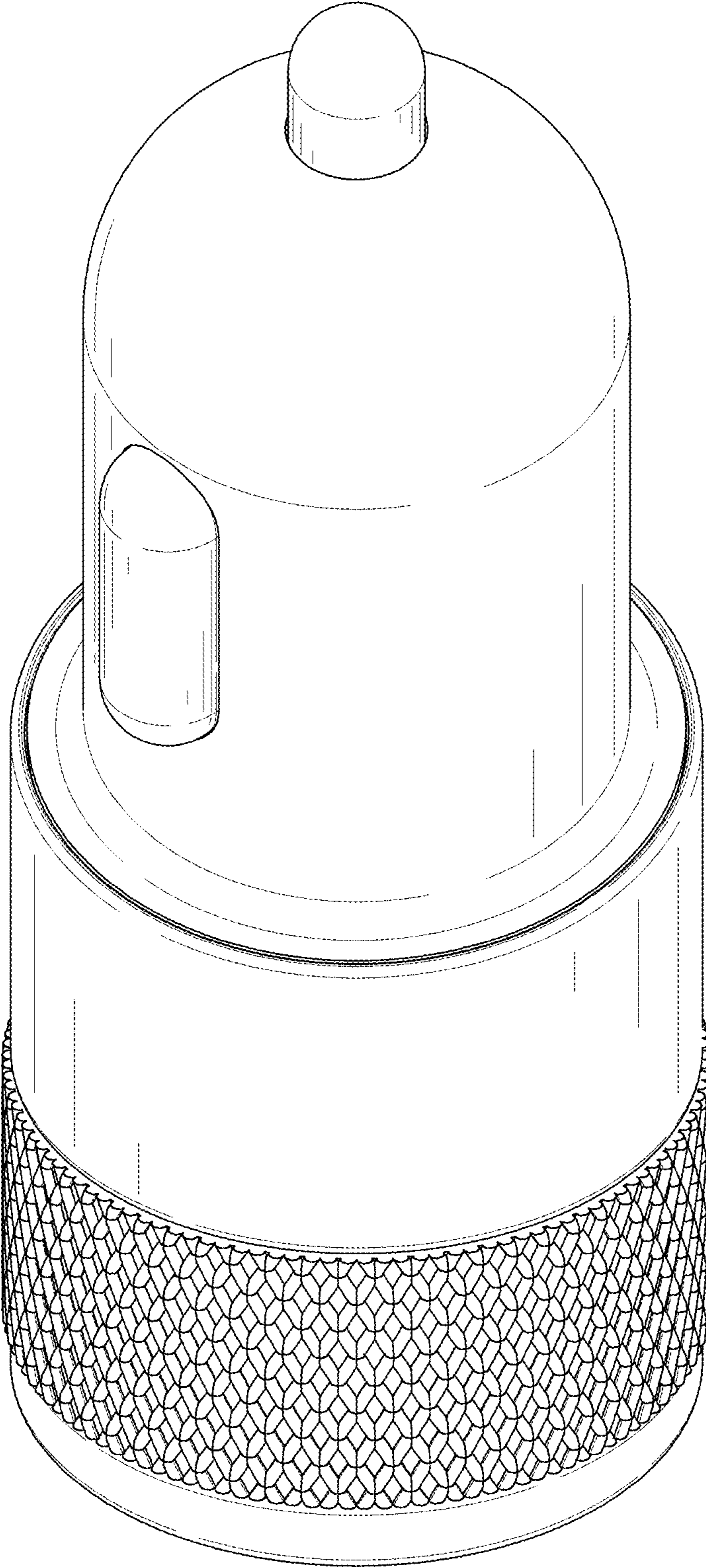

FIG. 2

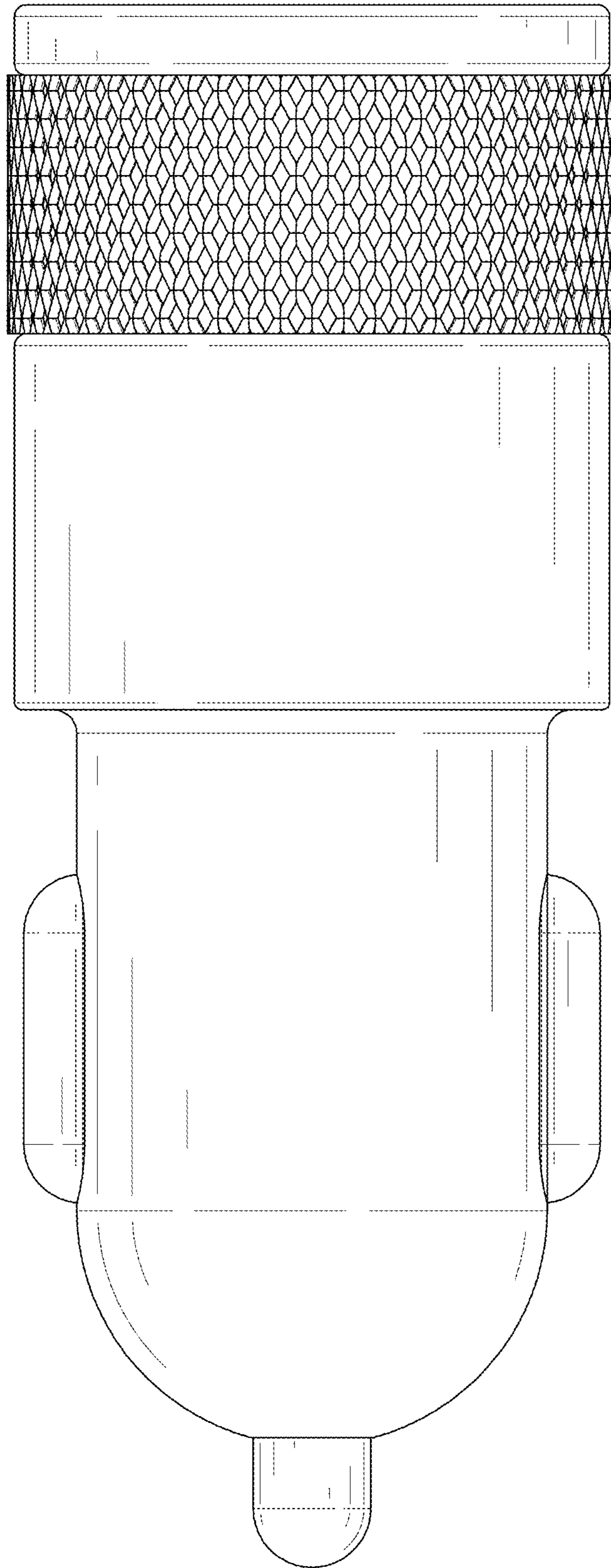

FIG. 3

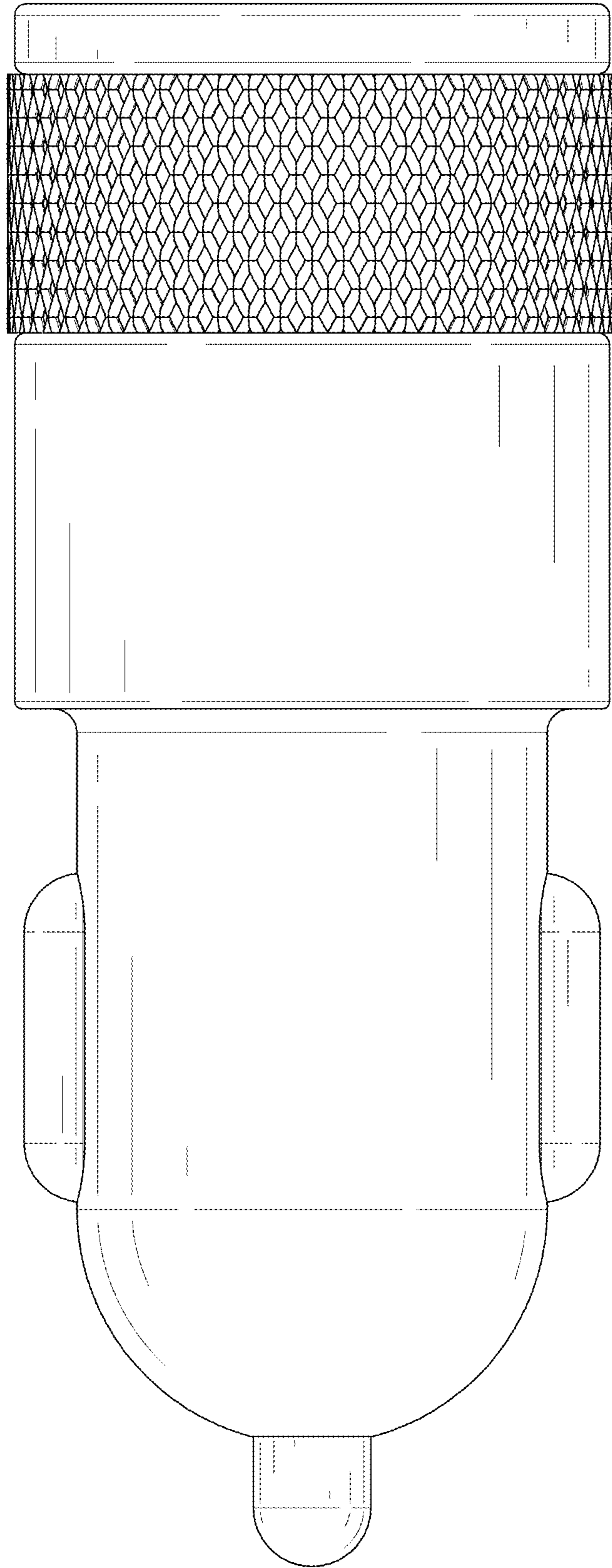

FIG. 4

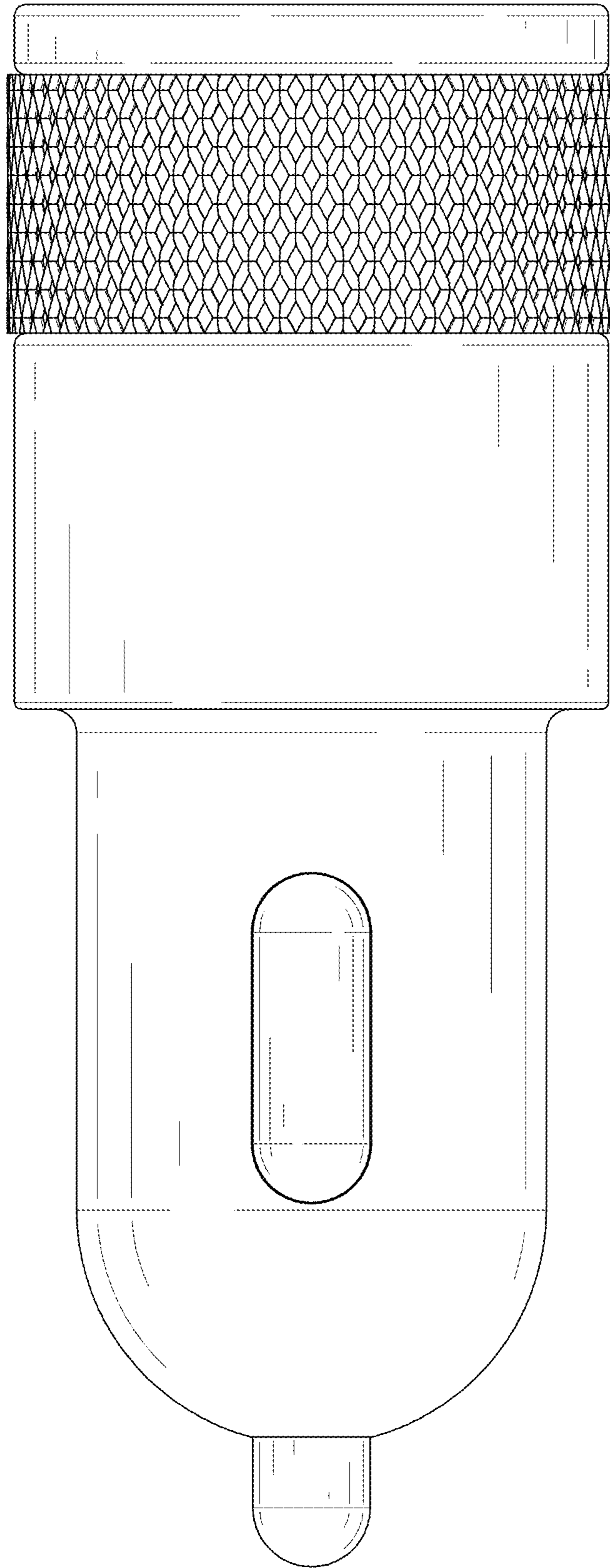

FIG. 5

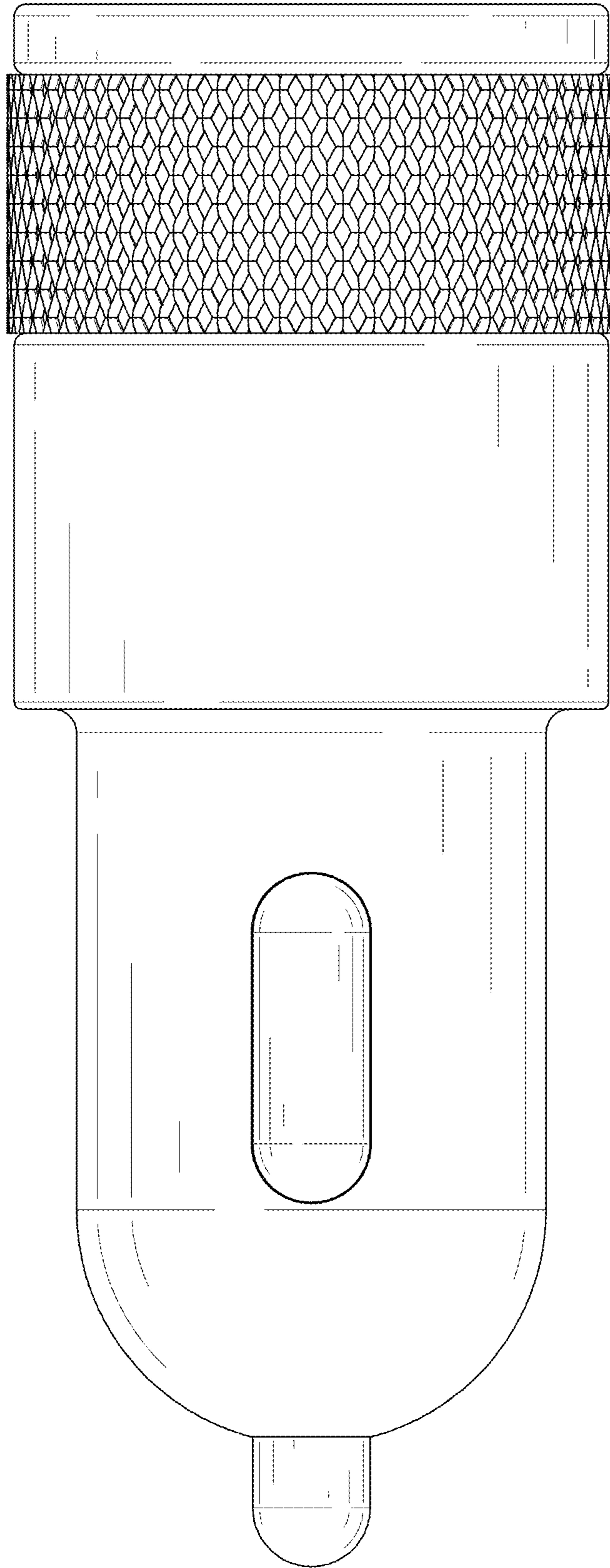

FIG. 6

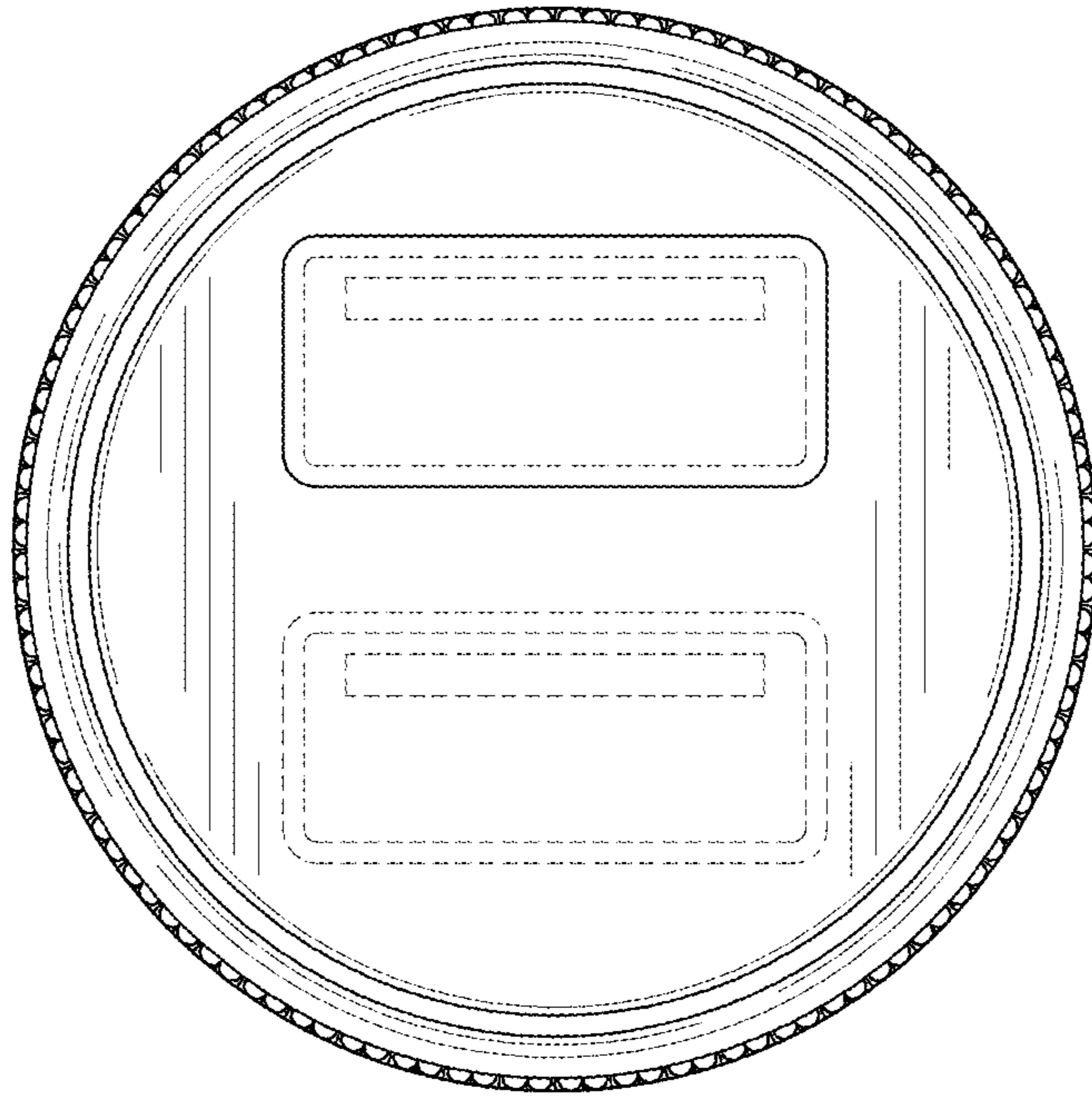

FIG. 7

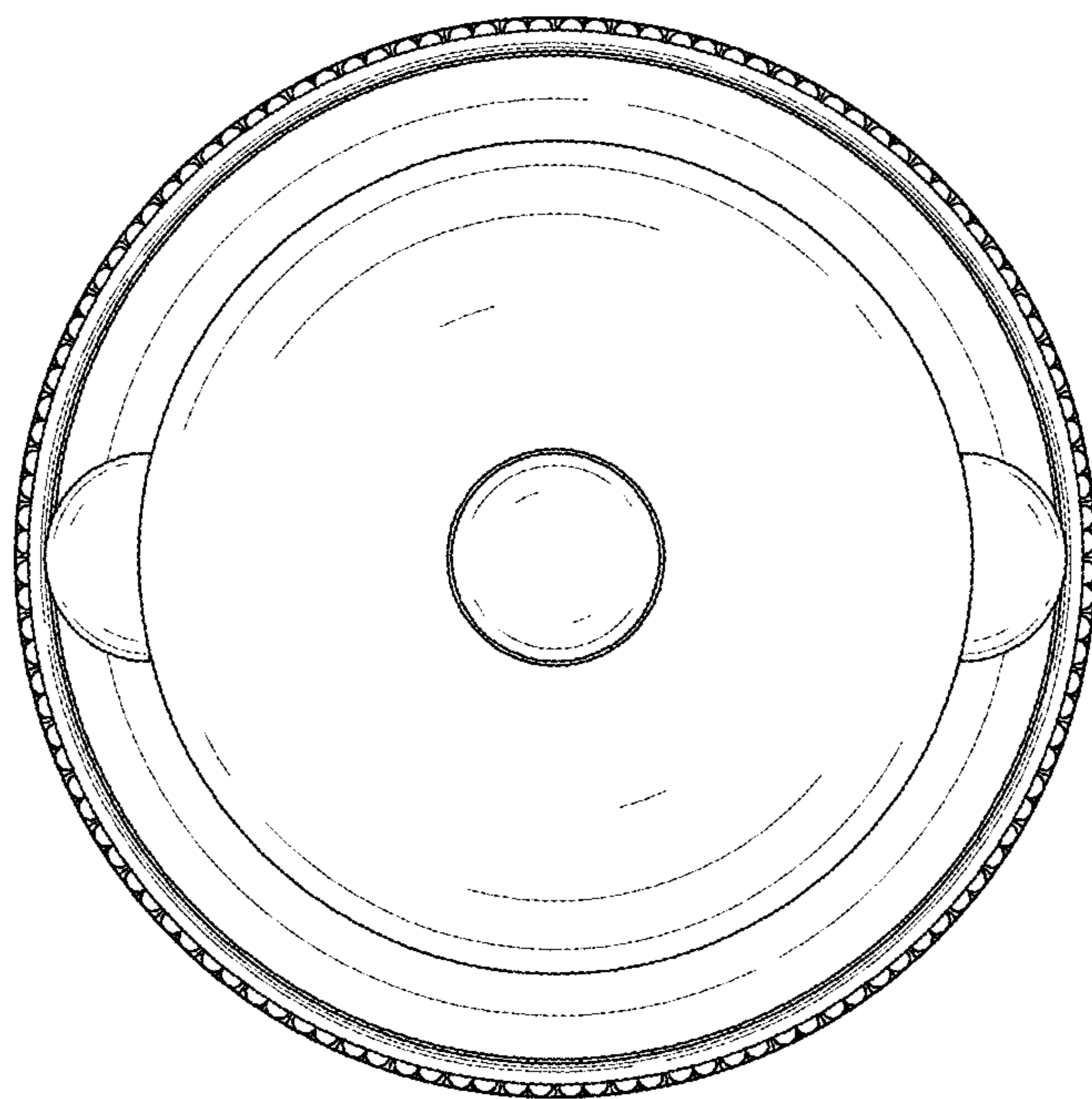

FIG. 8