



US00D949085S

(12) **United States Design Patent** (10) **Patent No.:** **US D949,085 S**
Harada (45) **Date of Patent:** **** Apr. 19, 2022**

(54) **ROTOR FOR MULTICOPTERS**
(71) Applicant: **JAPAN AEROSPACE EXPLORATION AGENCY**, Tokyo (JP)
(72) Inventor: **Masashi Harada**, Tokyo (JP)
(73) Assignee: **Japan Aerospace Exploration Agency**, Tokyo (JP)
(**) Term: **15 Years**
(21) Appl. No.: **29/724,253**
(22) Filed: **Feb. 13, 2020**
(30) **Foreign Application Priority Data**

Feb. 6, 2020 (JP) 2020-002180

(51) **LOC (13) Cl.** **12-16**
(52) **U.S. Cl.**
USPC **D12/214**

(58) **Field of Classification Search**
USPC D12/214, 317, 319, 328, 330, 344, 345, D12/16.1; D15/4, 5; D13/115; D21/441; D23/411, 413, 379
CPC B64C 11/00; B64C 11/02; B64C 11/16; B64C 11/26; B64C 11/28; B64C 27/08; B64C 39/024; B64C 2201/108; B63H 1/18; B63H 1/20; B63H 1/26
See application file for complete search history.

(56) **References Cited**

U.S. PATENT DOCUMENTS

1,361,277 A * 12/1920 Mott B64C 11/16 416/237
D252,390 S * 7/1979 Voisard 416/214 R
D633,956 S * 3/2011 Cheng D21/442
9,057,273 B2 * 6/2015 Wang A63H 27/02
D751,026 S * 3/2016 Tao D12/345
D751,491 S * 3/2016 Chen D12/319

D755,703 S * 5/2016 Hanscom D12/345
D761,184 S * 7/2016 Xiao D12/214
D790,430 S * 6/2017 Ali D12/214
D792,318 S * 7/2017 Du D12/214
D798,219 S * 9/2017 Xiao D12/214
D820,917 S * 6/2018 Perryman D21/453
D839,815 S * 2/2019 Jiang D12/214
2009/0220347 A1 * 9/2009 Ball B64C 11/26 416/229 R
2012/0189457 A1 * 7/2012 Occhipinti B64C 11/16 416/235
2015/0336670 A1 * 11/2015 Zhang B29C 43/003 244/119

* cited by examiner

Primary Examiner — Michelle E. Wilson
Assistant Examiner — Clese Moore, Jr.
(74) *Attorney, Agent, or Firm* — Saliwanchik, Lloyd & Eisenschenk

(57) **CLAIM**

The ornamental design for a rotor for multicopters, as shown and described.

DESCRIPTION

FIG. 1 is a top perspective view of a rotor for multicopters showing my new design;
FIG. 2 is a bottom perspective view thereof;
FIG. 3 is a front elevational view thereof;
FIG. 4 is a rear elevational view thereof;
FIG. 5 is a right side elevational view thereof;
FIG. 6 is a left side elevational view thereof;
FIG. 7 is a top plan view thereof;
FIG. 8 is a bottom plan view thereof;
FIG. 9 is a cross-section view of the rotor for multicopters taken along line 9-9 in FIG. 7;
FIG. 10 is a cross-section view of the rotor for multicopters taken along line 10-10 in FIG. 7; and,
FIG. 11 is a cross-section view of the rotor for multicopters taken along line 11-11 in FIG. 7.

1 Claim, 8 Drawing Sheets

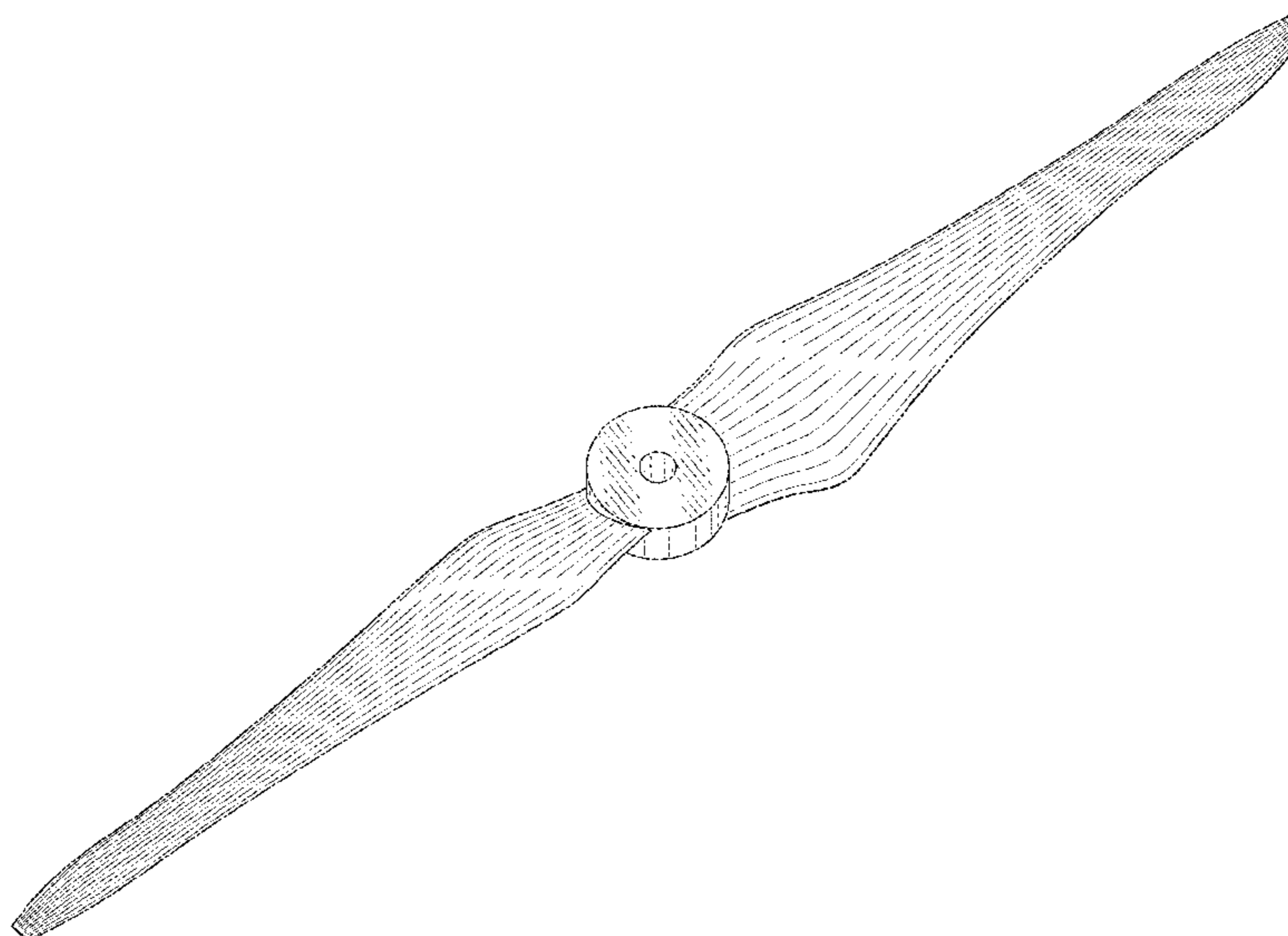

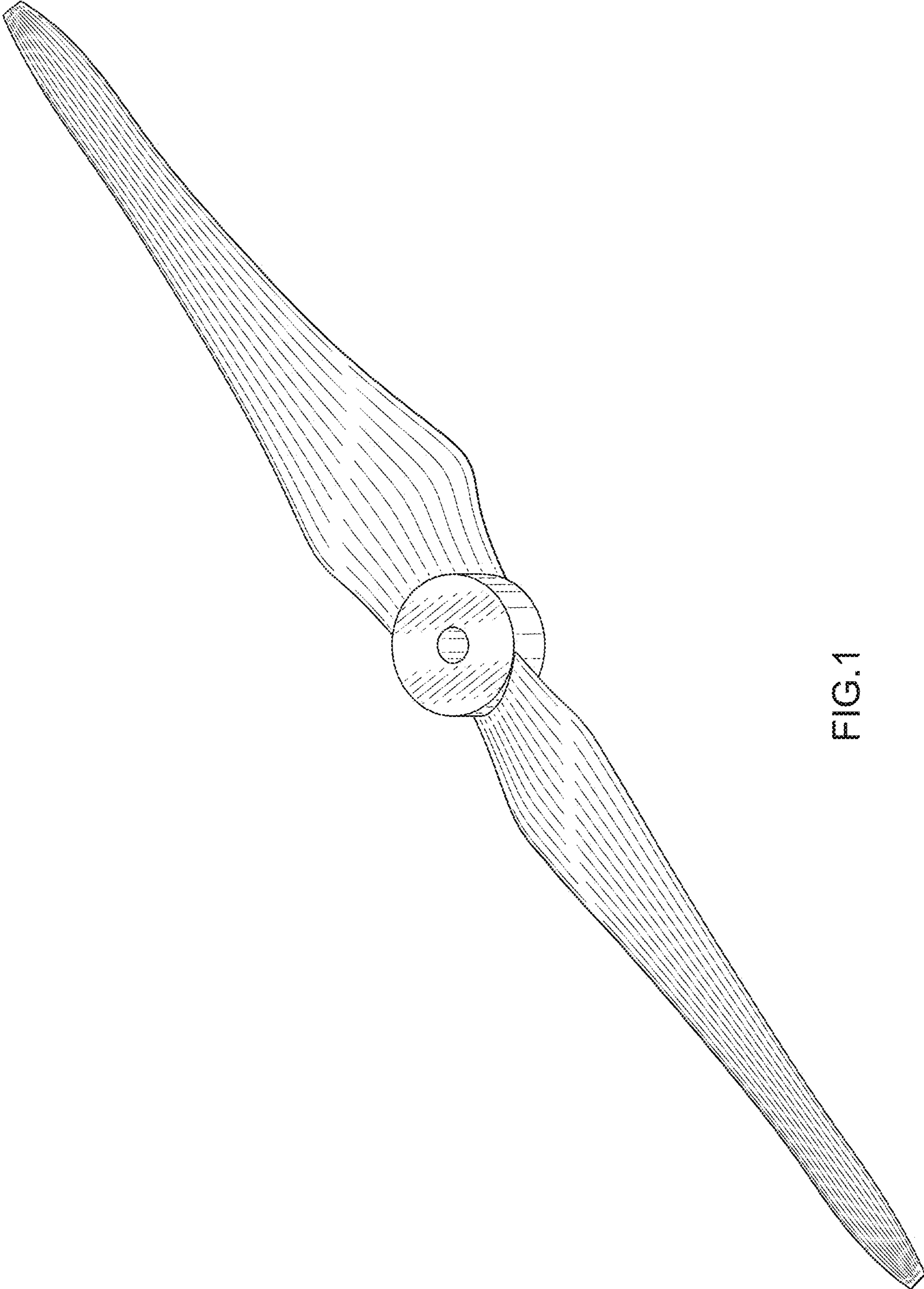

FIG. 1

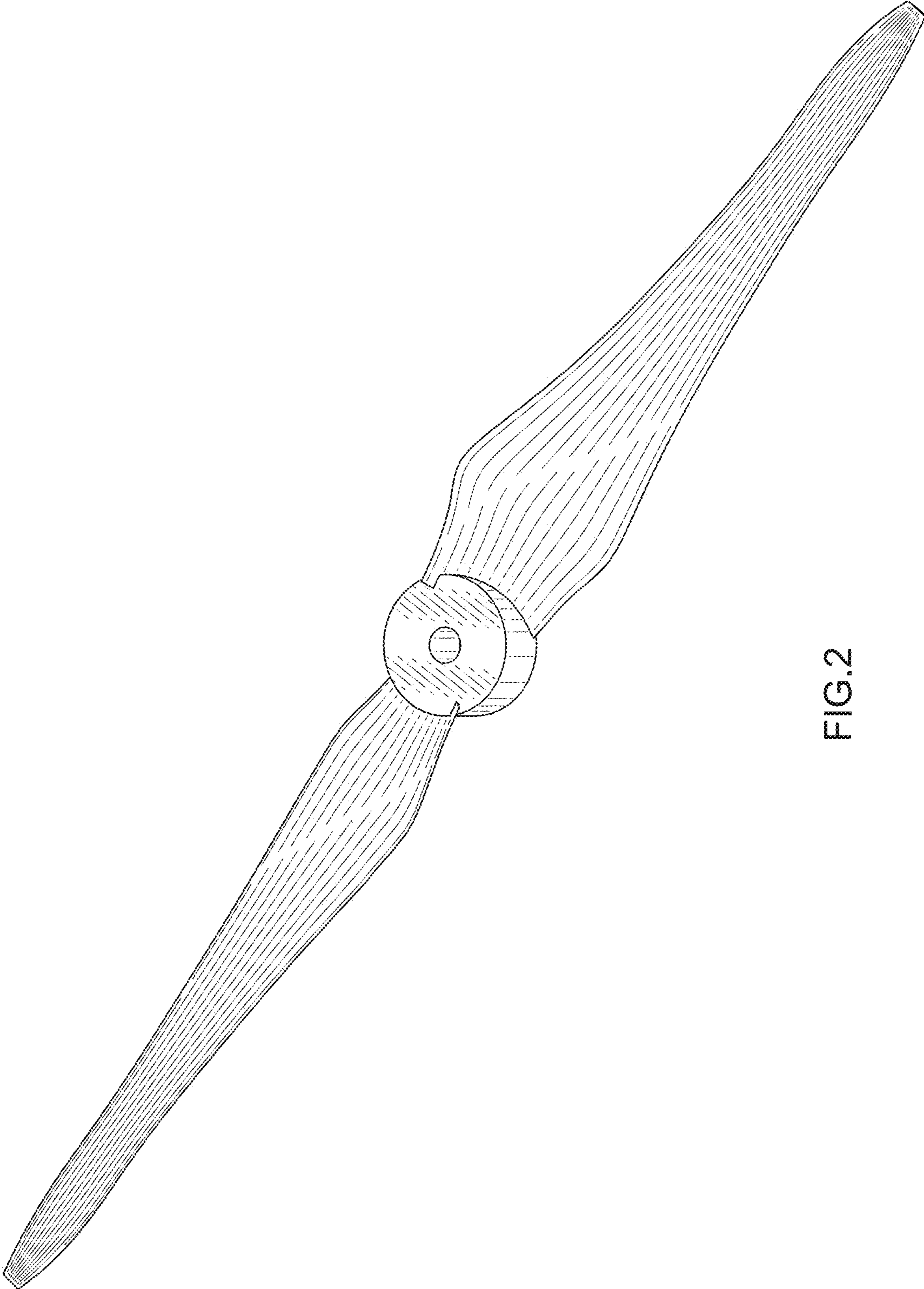

FIG.2

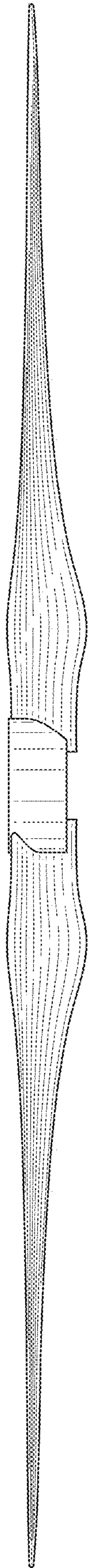

FIG.3

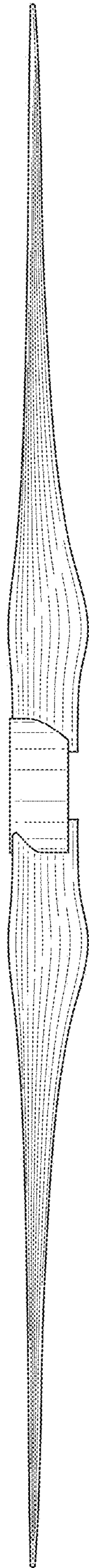

FIG.4



FIG.5

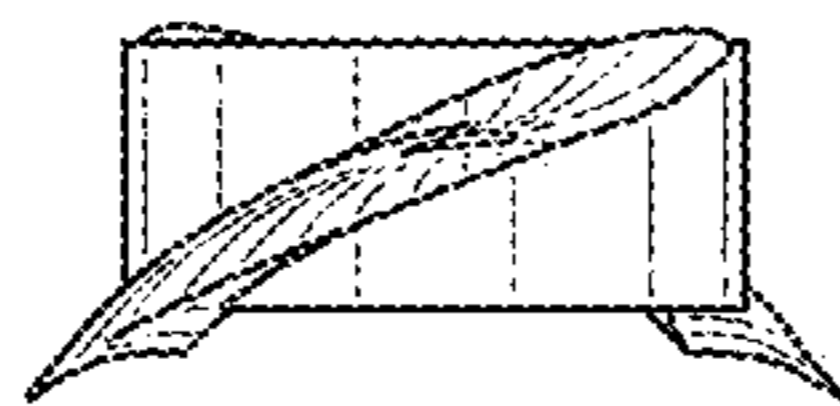
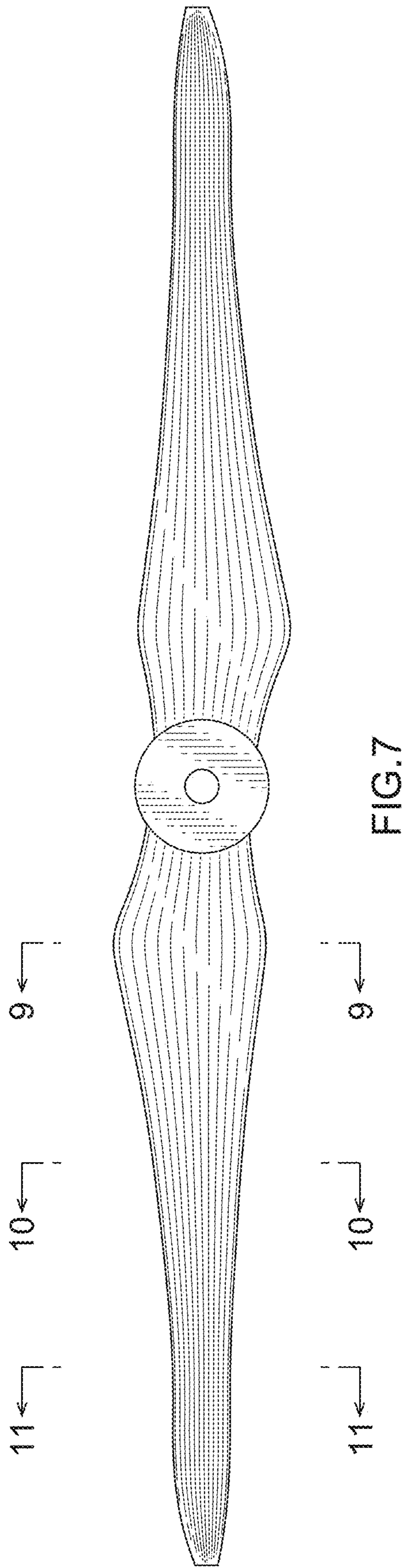

FIG.6



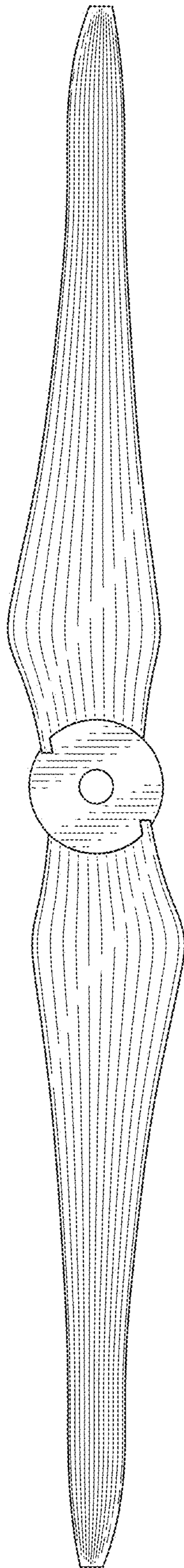

FIG. 8

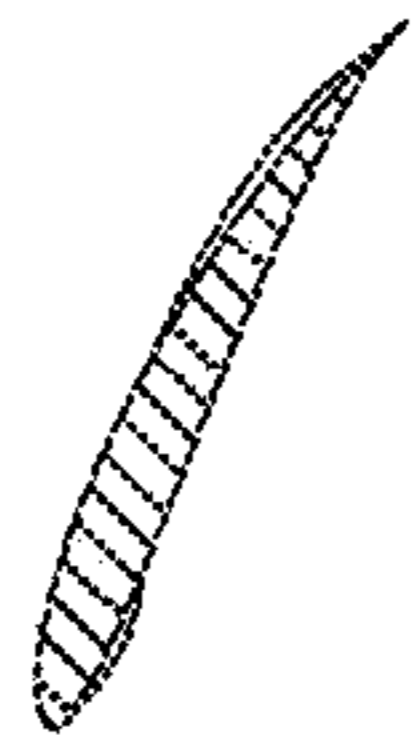

FIG. 9



FIG. 10



FIG. 11